

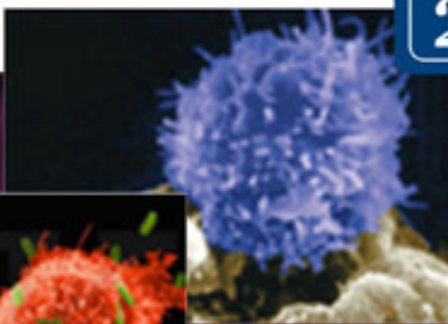

*Textbook of*

# Microbiology & Immunology

2<sup>nd</sup> Edition

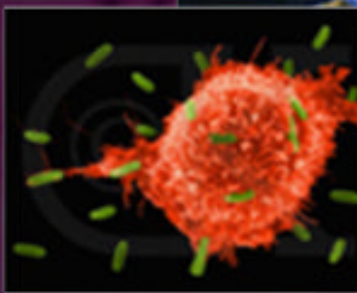

Subhash Chandra Parija

*Textbook of*

**Microbiology  
and  
Immunology**

"This page intentionally left blank"

*Textbook of*  
**Microbiology  
and  
Immunology**  
*2nd Edition*

**Subhash Chandra Parija**

MBBS, MD, PhD, DSc, FRCPath

FAMS, FICPath, FICAI, FABMS, FISCd, FIAVP, FIATP, FIMSA

*Professor and Head*

Department of Microbiology

Jawaharlal Institute of Postgraduate Medical Education and Research  
Puducherry, India



**ELSEVIER**

*A division of*

Reed Elsevier India Private Limited

**Textbook of Microbiology and Immunology, 2/e**

Parija

ELSEVIER

*A division of*

Reed Elsevier India Private Limited

*Mosby, Saunders, Churchill Livingstone, Butterworth-Heinemann and Hanley & Belfus are the Health Science imprints of Elsevier.*

© 2012 Elsevier

First Edition 2009

Second Edition 2012

All rights are reserved. No part of this publication may be reproduced, stored in a retrieval system, or transmitted in any form or by any means, electronic, mechanical, photocopying, recording, or otherwise without the prior permission of the publisher.

ISBN: 978-81-312-2810-4

Medical knowledge is constantly changing. As new information becomes available, changes in treatment, procedures, equipment and the use of drugs become necessary. The author, editors, contributors and the publisher have, as far as it is possible, taken care to ensure that the information given in this text is accurate and up-to-date. However, readers are strongly advised to confirm that the information, especially with regard to drug dose/usage, complies with current legislation and standards of practice. *Please consult full prescribing information before issuing prescriptions for any product mentioned in this publication.*

Published by Elsevier, a division of Reed Elsevier India Private Limited.

*Registered Office:* 305, Rohit House, 3 Tolstoy Marg, New Delhi-110 001.

*Corporate Office:* 14th Floor, Building No. 10B, DLF Cyber City, Phase II, Gurgaon-122 002, Haryana, India.

*Sr. Commissioning Editor:* Shukti Mukherjee Bhattacharya

*Managing Editor (Development):* Shabina Nasim

*Development Editor:* Shravan Kumar

*Copy Editor:* Shrayosee Dutta

*Manager Publishing Operations:* Sunil Kumar

*Manager Production:* NC Pant

Typeset by Mukesh Technologies Pvt. Ltd., Pudhucherry, India.

Printed and bound at EIH Unit Ltd. Press, Manesar.

*To my father*

**Late Shri Managovinda Parija**

*and mother*

**Late Smt Nishamani Parija**

"This page intentionally left blank"

# Preface to the Second Edition

Like the first edition, the second edition of *Textbook of Microbiology and Immunology* consists of six sections. Section I and II deal with general microbiology and immunology, respectively. Section III, IV, and V deal with bacteriology, virology, and mycology, respectively. Lastly, Section VI deals with applied microbiology and includes epidemiology and control of community infections, hospital infections, antimicrobial chemotherapy, water analysis, and immunization.

Medical microbiology is a rapidly changing and evolving field. The threat of emerging and reemerging pathogens and the changing epidemiology of known pathogens have made it imperative that we keep abreast of the changes and developments in the field if we are to efficiently deal with them.

The second edition of the *Textbook of Microbiology and Immunology* has been revised thoroughly and revamped to include the latest information in the field of medical microbiology. Special emphasis has been placed on molecular methods of diagnosis, which have revolutionized the diagnosis of infectious diseases and have made it possible to detect hitherto unknown and uncultivable pathogens from clinical specimens. The problem of antimicrobial resistance with respect to emerging mechanisms, changing epidemiology, and newer ways of detection has been dealt with in detail.

This text aims at not only providing basic information about microbiology and immunology, but also deals with the clinical applications of microbiology in the study of infectious diseases. In each chapter, key points are highlighted. Clinical case studies have been included so that students can evaluate their understanding of the various microbes. Photographs and pertinent line diagrams have been included to aid the learning process. The book has been trimmed down so as to include the necessary information without overburdening the students.

This textbook aims at providing comprehensive information about microbiology and its applications for medical students, para-medical students and workers in the field of infectious diseases. I sincerely hope the book serves this purpose and also helps in creating interest towards the subject among students.

Readers' views and suggestions for further improving the book in the coming years are welcome. Suggestions may kindly be e-mailed at [subhashparija@yahoo.co.in](mailto:subhashparija@yahoo.co.in).

**Subhash Chandra Parija**





# Preface to the First Edition

The intent of the book is to provide an up-to-date information on microbial diseases which are emerging as an important health problem world wide. This book has been written to provide a comprehensive coverage of basic and clinical microbiology, including immunology, bacteriology, virology, and mycology, in a clear and succinct manner. The book also intends to provide an accurate presentation of clinically relevant information to the learners of medical microbiology.

*Textbook of Microbiology and Immunology* consists of six sections. Section I and II deals with general micro biology and immunology, respectively. Section III, IV, and V deals with bacteriology, virology, and mycology, respectively. Lastly, Section VI deals with applied microbiology and includes epidemiology and control of community infections, hospital infections, antimicrobial chemotherapy, water analysis, and immunization.

Emphasis, throughout the text, is made on the clinical applications of microbiology to study infectious diseases. Cultivation and identification of each organism along with pathogenesis of diseases, clinical manifestations, diagnostic laboratory tests, treatment, and prevention and control of resulting infections are thoroughly updated to include most recent advances in the field. Details are summarized in the tabular format. Clinical cases are provided in most of the chapters. The book is profusely illustrated with line diagrams and photomicrographs both black & white and color.

I believe this book will be a useful source of comprehensive information for students mainly the undergraduate students of medicine, allied sciences, and others who are interested in medical microbiology.

I welcome reader's views and suggestions for further improvement of the book in the future edition. Suggestions may kindly be e-mailed at [subhashparija@yahoo.co.in](mailto:subhashparija@yahoo.co.in) or at [infoindia@elsevier.com](mailto:infoindia@elsevier.com).

**Subhash Chandra Parija**

# Acknowledgements

I am grateful for the valuable professional help and support provided by the staff at Elsevier, New Delhi, namely, Mr Sumeet Rohatgi, Mr Vidhu Goel, Ms Shabina Nasim, and Mr Shravan Kumar during a period of last more than one year. It has been really a wonderful and learning experience while working in particular with Ms Shabina Nasim and Mr Shravan Kumar; their professional contributions are immense for the development of manuscript to the present book format. I gratefully acknowledge all my colleagues, friends, and students for their valuable advice, constructive criticism, and assistance in preparation of the manuscript.

I owe special debt of profound gratitude to my mother late Smt Nishamani Parija and father late Shri Managovinda Parija without whose encouragement the book would not have been possible. I am indeed grateful to my wife Smt Jyothirmayee Parija for all her support throughout the period of preparation of the manuscript of the book.

It is my pleasure to thank my niece Er Kukumina Parija, son-in-law Er Subhasis Ray, nephew Er Shri Rajkumar Parija, daughter-in-law Ms Smriti Parija, and daughters, Ms Dr Madhuri Parija, son-in-law Dr Ajay Halder, Ms Er Mayuri Parija and son-in-law Er Shailesh Nandan for their untiring secretarial help towards the preparation of the manuscript.

**Subhash Chandra Parija**

# Contents

<i>Preface to the Second Edition</i>	<i>vii</i>
<i>Preface to the First Edition</i>	<i>ix</i>
<i>Acknowledgements</i>	<i>x</i>
<i>Color Photos</i>	<i>CP1</i>

## SECTION I GENERAL MICROBIOLOGY

### 1. History of Microbiology 3

- Introduction 3
- Historical Background 3
- Microorganisms as a Cause of Disease 3
- Study of Viruses 6
- Phenomenon of Immunity 7
- Chemotherapeutic Agents 8

### 2. Morphology and Physiology of Bacteria 9

- Introduction 9
- Size of Bacteria 9
- Microscopy 9
- Study of Bacteria 12
- Structure and Functions of Bacterial Cell Envelope 14
- Growth and Multiplication of Bacteria 21
- Bacterial Nutrition 23

### 3. Sterilization and Disinfection 24

- Introduction 24
- Definition of Frequently Used Terms 24
- Sterilization 24
- Disinfection 29

### 4. Culture Media 34

- Introduction 34
- Ingredients of Culture Media 34
- Types of Culture Media 34

### 5. Culture Methods 38

- Introduction 38
- Methods of Culture 38
- Anaerobic Culture 39

### 6. Laboratory Identification of Bacteria and Taxonomy 41

- Introduction 41
- Identification of Bacteria 41
- Bacterial Taxonomy 45

### 7. Bacterial Genetics 47

- Introduction 47
- Chromosomal Substances 47
- Mutations 48
- Extrachromosomal DNA Substances 49
- Transfer of DNA Within Bacterial Cells 50
- Transfer of DNA Between Bacterial Cells 51
- Recombination 54

### 8. Genetic Engineering and Molecular Methods 55

- Introduction 55
- DNA: An Amazing Molecule 55
- Genetic Engineering 55
- Nucleic Acid Probes 57
- Polymerase Chain Reaction 57
- Recombinant DNA Technology 59
- Genetically Modified Organisms 60
- Gene Therapy 60

### 9. Antimicrobial Agents: Therapy and Resistance 61

- Introduction 61
- Mechanisms of Action of Antimicrobial Drugs 61
- Resistance to Antimicrobial Drugs 64
- Basis of Resistance 65
- Antibiotic Sensitivity Testing 68
- Antibacterial Assays in Body Fluids 71

### 10. Microbial Pathogenesis 72

- Introduction 72
- Types of Microorganisms 72
- Infection 72

## xii CONTENTS

- Stages of Pathogenesis of Infections 73
- Stages of an Infectious Disease 82

### SECTION II IMMUNOLOGY

#### 11. Immunity 85

- Introduction 85
- Types of Immunity 85

#### 12. Antigen 90

- Introduction 90
- Determinants of Antigenicity 90
- Antigenic Specificity 91
- Species Specificity 92
- Isospecificity 92
- Autospecificity 92
- Organ Specificity 92
- Heterophile Specificity 92
- Haptens 93
- Superantigens 93

#### 13. Antibodies 94

- Introduction 94
- Immunoglobulins 94
- Abnormal Immunoglobulins 100

#### 14. Antigen–Antibody Reactions 101

- Introduction 101
- General Features of Antigen–Antibody Reactions 101
- Stages of Antigen–Antibody Reactions 102
- Types of Antigen–Antibody Reactions 102

#### 15. Complement System 116

- Introduction 116
- The Complement System 116
- Activation of Complement 116
- Regulation of Complement System 119
- Biological Effects of Complement 120
- Deficiency of Complement 121
- Biosynthesis of Complement 121
- Quantitation of Complement 121

#### 16. Structure and Function of Immune System 122

- Introduction 122
- Lymphoid Tissues and Organs 122
- Lymphatic Circulatory System 124
- Cells of the Lymphoreticular System 124
- Major Histocompatibility Complex 131

#### 17. Immune Response 134

- Introduction 134
- Humoral Immunity 134
- Cell-Mediated Immunity 138
- Transfer Factor 142
- Immunological Tolerance 142

#### 18. Immunodeficiency 143

- Introduction 143
- Primary Immunodeficiencies 143
- Secondary Immunodeficiencies 147

#### 19. Hypersensitivity 149

- Introduction 149
- Type I (Anaphylactic) Hypersensitivity 149
- Type II (Cytotoxic) Hypersensitivity 152
- Type III (Immune-Complex) Hypersensitivity 153
- Type IV Delayed (Cell-Mediated) Hypersensitivity 154
- Type V (Stimulatory Type) Hypersensitivity 155

#### 20. Autoimmunity 156

- Introduction 156
- Tolerance 156
- Pathogenesis of Autoimmunity 156
- Animal Models of Autoimmunity 158
- Autoimmune Diseases 158

#### 21. Immunology of Transplantation and Malignancy 161

- Introduction 161
- Transplant Immunology 161
- Tumor Immunology 164

#### 22. Immunohematology 167

- Introduction 167
- ABO Blood Group System 167
- Rh Blood Group System 168
- Blood Transfusion 168
- Hemolytic Disease of Newborn (Erythroblastosis Fetalis) 169
- ABO Hemolytic Diseases 170

### SECTION III BACTERIOLOGY

#### 23. *Staphylococcus* 173

- Introduction 173
- *Staphylococcus* 173
- *Staphylococcus aureus* 173
- Coagulase-Negative Staphylococci 181

• <i>Micrococcus</i>	182	• <i>Edwardsiella</i>	261
• <i>Planococcus</i>	182	• <i>Citrobacter</i>	261
• <i>Stomatococcus</i>	182	• <i>Klebsiella</i>	261
<b>24. Streptococcus and Enterococcus</b>	<b>183</b>	• <i>Enterobacter</i>	263
• Introduction	183	• <i>Hafnia</i>	264
• <i>Streptococcus</i>	183	• <i>Serratia</i>	264
• <i>Streptococcus pyogenes</i>	184	• <i>Proteus</i>	265
• <i>Streptococcus agalactiae</i>	191	• <i>Morganella</i>	267
• Other Hemolytic Streptococci	191	• <i>Providencia</i>	268
• Viridans Streptococci	192	• <i>Erwinia</i>	268
• <i>Enterococcus</i>	192	<b>32. Salmonella</b>	<b>269</b>
<b>25. Pneumococcus</b>	<b>194</b>	• Introduction	269
• Introduction	194	• <i>Salmonella</i>	269
• <i>Streptococcus pneumoniae</i>	194	• <i>Salmonella</i> Gastroenteritis	280
<b>26. Neisseria</b>	<b>201</b>	• <i>Salmonella</i> Bacteremia	280
• Introduction	201	<b>33. Shigella</b>	<b>281</b>
• <i>Neisseria gonorrhoeae</i>	201	• Introduction	281
• <i>Neisseria meningitidis</i>	207	• <i>Shigella</i>	281
• Other <i>Neisseria</i> Species	211	<b>34. Yersinia</b>	<b>286</b>
<b>27. Corynebacterium</b>	<b>213</b>	• Introduction	286
• Introduction	213	• <i>Yersinia pestis</i>	286
• <i>Corynebacterium diphtheriae</i>	213	• <i>Yersinia enterocolitica</i>	291
• Other Pathogenic <i>Corynebacterium</i> Species	220	• <i>Yersinia pseudotuberculosis</i>	292
• Other Coryneform Genera	221	<b>35. Vibrio, Aeromonas, and Plesiomonas</b>	<b>294</b>
<b>28. Bacillus</b>	<b>222</b>	• Introduction	294
• Introduction	222	• <i>Vibrio cholerae</i>	294
• <i>Bacillus anthracis</i>	222	• Noncholera Vibrios	302
• Anthracoid Bacilli	229	• <i>Vibrio mimicus</i>	302
<b>29. Clostridium</b>	<b>231</b>	• Halophilic Vibrios	302
• Introduction	231	• Other <i>Vibrio</i> Species	303
• <i>Clostridium</i>	231	• <i>Aeromonas</i>	304
• <i>Clostridium perfringens</i>	232	• <i>Plesiomonas</i>	304
• <i>Clostridium tetani</i>	237	<b>36. Campylobacter and Helicobacter</b>	<b>305</b>
• <i>Clostridium botulinum</i>	242	• Introduction	305
• <i>Clostridium difficile</i>	245	• <i>Campylobacter</i>	305
<b>30. Nonsporing Anaerobes</b>	<b>247</b>	• <i>Helicobacter</i>	308
• Introduction	247	• <i>Helicobacter pylori</i>	308
• Anaerobic Cocci	247	• Other <i>Helicobacter</i> Species	311
• Anaerobic Bacilli	247	<b>37. Pseudomonas, Burkholderia, and Moraxella</b>	<b>313</b>
<b>31. Coliforms</b>	<b>251</b>	• Introduction	313
• Introduction	251	• <i>Pseudomonas</i>	313
• <i>Escherichia</i>	252	• <i>Pseudomonas aeruginosa</i>	313
• <i>Escherichia coli</i>	252	• Other <i>Pseudomonas</i> Species	318
		• <i>Burkholderia</i>	318
		• <i>Moraxella</i>	319

<b>38. <i>Haemophilus</i>, <i>Pasteurella</i>, and <i>Actinobacillus</i></b>	<b>321</b>		
• Introduction	321		
• <i>Haemophilus</i>	321		
• <i>Haemophilus influenzae</i>	321		
• Other <i>Haemophilus</i> Species	326		
• <i>Pasteurella</i>	327		
• <i>Actinobacillus</i>	327		
• HACEK Group of Bacteria	328		
<b>39. <i>Bordetella</i> and <i>Francisella</i></b>	<b>330</b>		
• Introduction	330		
• <i>Bordetella</i>	330		
• <i>Bordetella pertussis</i>	330		
• <i>Bordetella parapertussis</i>	334		
• <i>Bordetella bronchiseptica</i>	335		
• <i>Francisella tularensis</i>	335		
<b>40. <i>Brucella</i></b>	<b>338</b>		
• Introduction	338		
• <i>Brucella</i>	338		
<b>41. <i>Mycobacterium tuberculosis</i></b>	<b>345</b>		
• Introduction	345		
• <i>Mycobacterium tuberculosis</i>	346		
<b>42. Nontuberculous <i>Mycobacteria</i></b>	<b>358</b>		
• Introduction	358		
• Photochromogens	358		
• Scotochromogens	359		
• Nonphotochromogens	359		
• Rapid Growers	360		
<b>43. <i>Mycobacterium leprae</i> and <i>Mycobacterium lepraemurium</i></b>	<b>362</b>		
• Introduction	362		
• <i>Mycobacterium leprae</i>	362		
• <i>Mycobacterium lepraemurium</i>	370		
<b>44. <i>Treponema</i>, <i>Borrelia</i>, and <i>Leptospira</i></b>	<b>371</b>		
• Introduction	371		
• <i>Treponema</i>	371		
• <i>Treponema pallidum</i>	371		
• Nonvenereal Treponematoses	377		
• Nonpathogenic Treponemes	378		
• <i>Borrelia</i>	378		
• <i>Borrelia recurrentis</i>	378		
• <i>Borrelia vincenti</i>	381		
• <i>Borrelia burgdorferi</i>	381		
• <i>Leptospira</i>	381		
• <i>Leptospira interrogans</i> Complex	382		
<b>45. <i>Mycoplasma</i> and <i>Ureaplasma</i></b>	<b>386</b>		
• Introduction	386		
• <i>Mycoplasma pneumoniae</i>	386		
• Genital <i>Mycoplasma</i> Species	391		
• <i>Ureaplasma urealyticum</i>	391		
• Atypical Pneumonia	392		
<b>46. Actinomycetes</b>	<b>393</b>		
• Introduction	393		
• <i>Actinomyces</i>	393		
• <i>Nocardia</i>	395		
• <i>Rhodococcus</i>	397		
• <i>Gordonia</i> and <i>Tsukamurella</i>	398		
• Thermophilic <i>Actinomyces</i>	398		
• <i>Tropheryma whippelii</i>	398		
• <i>Dermatophilus</i>	398		
• <i>Oerskovia</i>	398		
<b>47. Miscellaneous Bacteria</b>	<b>399</b>		
• Introduction	399		
• <i>Listeria monocytogenes</i>	399		
• <i>Erysipelothrix rhusiopathiae</i>	400		
• <i>Alcaligenes faecalis</i>	400		
• <i>Chromobacterium violaceum</i>	400		
• <i>Flavobacterium meningosepticum</i>	400		
• <i>Calymmatobacterium</i>	400		
• <i>Streptobacillus</i> and <i>Spirillum</i>	401		
• <i>Streptobacillus moniliformis</i>	401		
• <i>Spirillum minus</i>	401		
• <i>Legionella</i>	401		
• <i>Legionella pneumophila</i>	402		
• <i>Bartonella</i>	404		
• <i>Capnocytophaga</i>	406		
• <i>Gardnerella vaginalis</i>	406		
<b>48. <i>Rickettsia</i>, <i>Orientia</i>, <i>Ehrlichia</i>, and <i>Coxiella</i></b>	<b>407</b>		
• Introduction	407		
• Genus <i>Rickettsia</i>	407		
• Typhus Fever Group	408		
• <i>Rickettsia prowazekii</i>	408		
• <i>Rickettsia typhi</i>	410		
• Spotted Fever Group	411		
• <i>Rickettsia rickettsiae</i>	411		
• Other Rickettsial Species in the Spotted Fever Group	413		
• <i>Rickettsia akari</i>	413		
• Genus <i>Orientia</i>	413		
• <i>Orientia tsutsugamushi</i>	413		
• Genus <i>Ehrlichia</i>	414		
• Genus <i>Coxiella</i>	415		
• <i>Coxiella burnetii</i>	416		

<b>49. Chlamydia and Chlamydophila</b>	<b>418</b>	<b>56. Papovaviruses</b>	<b>469</b>
• Introduction	418	• Introduction	469
• <i>Chlamydia</i>	418	• Human Papillomaviruses	469
• <i>Chlamydia trachomatis</i>	419	• Polyomaviruses	471
• <i>Chlamydophila</i>	423		
• <i>Chlamydophila pneumoniae</i>	424	<b>57. Herpesviruses</b>	<b>473</b>
• <i>Chlamydophila psittaci</i>	424	• Introduction	473
		• Herpes Simplex Virus	473
		• Herpesvirus Simiae: B Virus	479
		• Varicella Zoster Virus	479
		• Epstein–Barr Virus	481
		• Cytomegalovirus	485
		• Human Herpesvirus 6	487
		• Human Herpesvirus 7	488
		• Human Herpesvirus 8	488
		<b>58. Adenoviruses</b>	<b>489</b>
		• Introduction	489
		• Adenovirus	489
		• Adeno-Associated Viruses	492
		<b>59. Parvoviruses</b>	<b>493</b>
		• Introduction	493
		• Parvovirus B19	493
		<b>60. Picornaviruses</b>	<b>496</b>
		• Introduction	496
		• Enteroviruses	496
		• Poliovirus	496
		• Coxsackieviruses	501
		• Echoviruses	502
		• Other Enteroviruses	503
		• Rhinoviruses	503
		• Hepatitis A Virus	504
		<b>61. Orthomyxoviruses</b>	<b>505</b>
		• Introduction	505
		• Influenza Viruses	505
		<b>62. Paramyxoviruses</b>	<b>514</b>
		• Introduction	514
		• Measles Virus	514
		• Parainfluenza Virus	517
		• Mumps Virus	519
		• Respiratory Syncytial Virus	521
		• Nipah Virus	522
		• Hendra Virus	522
		• Human Metapneumovirus	522
		<b>63. Reoviruses</b>	<b>524</b>
		• Introduction	524
		• Orbiviruses	524

## SECTION IV VIROLOGY

### 50. General Properties of Viruses 429

- Introduction 429
- Morphology of Viruses 429
- Replication of Viruses 433
- Viral Genetics 435
- Nomenclature and Taxonomy of Viruses 437

### 51. Pathogenesis of Viral Infections 440

- Introduction 440
- Stages of Viral Infections 440
- Viral Pathogenesis at the Cellular Level 442
- Host Response to Viral Infections 445
- Clinical Manifestations of Viral Diseases 446
- Epidemiology 447

### 52. Antiviral Agents 449

- Introduction 449
- Mechanism of Action of Antiviral Drugs 449
- Classification of Antiviral Drugs 449

### 53. Laboratory Diagnosis of Viral Diseases 453

- Introduction 453
- Methods of Laboratory Diagnosis 453

### 54. Bacteriophages 460

- Introduction 460
- Morphology 460
- Life Cycle 460
- Uses of Bacteriophages 462
- Bacteriophage Typing 462

### 55. Poxviruses 463

- Introduction 463
- Variola (Smallpox) Virus 463
- Vaccinia Virus 466
- Monkeypox 467
- Buffalopox 467
- Cowpox 467
- Orf 467
- Molluscum Contagiosum 468
- Tanapox 468
- Yabapox 468



## xvi CONTENTS

- Coltiviruses 525
- Orthoreoviruses 525
- Rotavirus 526

### 64. Rhabdoviruses 529

- Introduction 529
- Rabies Virus 529
- Rabies-Related Viruses 534

### 65. Arboviruses 536

- Introduction 536
- Important Properties of Arboviruses 536
- Reboviruses 537
- Togaviruses 537
- Flaviviruses 539
- Bunyaviridae Viruses 544
- Reoviridae 546
- Rhabdoviridae 546
- Ungrouped Arboviruses 546

### 66. Hepatitis Viruses 547

- Introduction 547
- Hepatitis A Virus 547
- Hepatitis B Virus 550
- Hepatitis C Virus 555
- Hepatitis D Virus 557
- Hepatitis E Virus 558
- Hepatitis G Virus 559

### 67. Retroviruses 560

- Introduction 560
- Retroviruses 560
- Human T-Lymphotropic Viruses 563
- Endogenous Retroviruses 565
- Other Oncogenic Viruses 565

### 68. Human Immunodeficiency Virus 566

- Introduction 566
- HIV Virus 566

### 69. Slow Viruses and Prions 578

- Introduction 578
- Slow Diseases Caused by Prions 578
- Slow Diseases Caused by Conventional Viruses in Humans 582
- Slow Diseases Caused by Conventional Viruses in Animals 582

### 70. Miscellaneous Viruses 583

- Introduction 583
- Rubella Virus 583
- Norwalk Virus 585

- Viral Hemorrhagic Fever 586
- Arenavirus 586
- Coronaviruses 588

## SECTION V MYCOLOGY

### 71. Introduction to Mycology 593

- Introduction 593
- Classification of Fungi 593
- Reproduction of Fungi 593
- Pathogenesis of Fungal Infection 594
- Laboratory Diagnosis 595
- Antifungal Drugs 596

### 72. Superficial, Cutaneous, and Subcutaneous Mycoses 597

- Introduction 597
- Superficial Mycoses 597
- Cutaneous Mycoses 598
- Subcutaneous Mycosis 600

### 73. Systemic Mycoses 603

- Introduction 603
- Coccidioidomycosis 603
- Paracoccidioidomycosis 604
- Histoplasmosis 604
- Blastomycosis 605
- Cryptococcosis 606

### 74. Opportunistic Fungal Infections 608

- Introduction 608
- Candidiasis 608
- *Candida albicans* 608
- Aspergillosis 610
- *Aspergillus* Species 610
- Zygomycosis 612
- Pneumocystosis 612
- *Pneumocystis jiroveci* 613
- Penicilliosis 614
- *Penicillium marneffei* 614
- *Pseudoallescheria boydii* Infection 615
- *Fusarium solani* Infection 615

## SECTION VI APPLIED MICROBIOLOGY

### 75. Normal Microbial Flora 619

- Introduction 619
- Functions of Resident Flora 619
- Factors Determining the Colonization by Microbes 619
- Normal Flora at Various Sites of the Body 620

**76. Bacteriology of Water, Milk, and Air** 623

- Introduction 623
- Bacteriology of Water 623
- Bacteriology of Milk 626
- Bacteriology of Air 628

**77. Nosocomial Infections** 629

- Introduction 629
- Factors Affecting Hospital-Acquired Infection 629
- Epidemiology of Hospital-Acquired Infection 629
- Diagnosis of Hospital-Acquired Infections 632
- Prevention and Control of Hospital-Acquired Infections 632

**78. Biomedical Waste Management** 634

- Introduction 634
- Types of Biomedical Waste 634
- Waste Treatment and Disposal 634

**79. Immunoprophylaxis** 637

- Introduction 637
- Active Immunization 637
- Immunization Schedule 638
- Passive Immunization 638
- Combined Active and Passive Immunization 639
- Individual Immunization 639

*Index* 641

# History of Microbiology

## Introduction

Medical microbiology is a branch of microbiology that deals with the study of microorganisms including bacteria, viruses, fungi, and parasites of medical importance that are capable of causing diseases in humans. It also includes the study of microbial pathogenesis, disease pathology, immunology, and epidemiology of diseases.

Medical microbiology is among the most widely studied branches of Microbiology. It has given mankind a chance to fight the organisms that, at one point of time, were pure nemesis to us. This has also provided an in-depth knowledge and in-detail understanding of the nature of pathogens that cause disease in humans. This field of microbiology has been the precursor to the wide gamut of immunological innovations in the field of medical science. This field not only has helped to develop vaccines against many invading organisms, it has also, in a more holistic way, given mankind a second shot at life. Deadly and debilitating diseases like smallpox, polio, rabies, plague, etc. have been either eradicated or have become treatable now because of the efforts of scientists and researchers in the field of medical microbiology.

Microbes are the most significant life forms sharing this planet with humans because of their pervasive presence. Depending on their food sources, microbes may have either beneficial roles in maintaining life or undesirable roles in causing human, animal, and plant diseases. These microbes cause frequent and often severe diseases, such as AIDS, cholera, tuberculosis, rabies, malaria, etc. The ubiquitous presence of microbes in large numbers have given rise to the many mutants, which in part are responsible for emerging diseases such as AIDS, Ebola hemorrhagic fever, and multidrug-resistant tuberculosis (MDRTB).

## Historical Background

Microbial diseases have undoubtedly played a major role in historical events, such as the decline of the Roman Empire and the conquest of the New World. In 1347, plague or Black Death struck Europe with a brutal force. By 1351, about 4 years later, the plague had killed one-third of the population (about 25 million people). Over the next 80 years, the disease has struck repeatedly, eventually wiping out 75% of the European

population. Some historians believe that this disaster changed European culture and prepared the way for the Renaissance. This is just an example from many such epidemics, which while being devastating in their scope spared not even the high and mighty of the times.

Apart from the bubonic plague, measles (now thankfully extinct) and smallpox too played their roles as epidemic diseases causing high mortality and morbidity. The first recorded epidemic of smallpox was in the year 1350 BC in Egypt. The disease was unknown in the population of the New World until the Portuguese and Spanish explorers made their appearance. Smallpox then traveled across America, devastating the previously unexposed population. It was already known at that time that the disease spreads through the skin lesions and scabs, and that survivors of the infection were immune to reinfection on further exposure. Though adopted much later in America and Europe, the practice of inoculation or variolation, whereby people were intentionally exposed to smallpox to make them immune, was already being practiced in India, China, and Africa for centuries.

## Microorganisms as a Cause of Disease

Among various causes, the causes suggested for the occurrence of disease were the effect of supernatural phenomena like planetary alignments and effect of bad bodily humors; the faulty environment was also implicated.

Even before microorganisms were seen, some investigators suspected their existence and responsibility for disease. Among others, the Roman philosopher Lucretius (about 98–55 BC) and the physician Girolamo Fracastoro (1478–1553 AD) suggested that disease was caused by invisible living creatures. Fracastoro was much more than an author of the popular poem on syphilis. In his book “*De contagione, contagiosis morbis et curatione* (On Contagion, Contagious Diseases, and their Treatment),” published in 1546, he proposed the revolutionary theory that infectious diseases are transmitted from person to person by minute invisible particles. He further suggested that infections spread from person to person by minute invisible seeds, or seminaria, that are self-replicating and act on the humors of the body to cause disease. His theories were ahead of their time, and it took about 200 years for the microscope to be invented and his theories to be proved.

## Antony van Leeuwenhoek: The Microscopist

The first person to observe and describe microorganisms accurately was an amateur microscopist Antony van Leeuwenhoek (1632–1723) of Delft, Holland. Leeuwenhoek earned his living as a draper and haberdasher (a dealer in men's clothing and accessories), but spent much of his spare time constructing simple microscopes composed of double convex glass lenses held between two silver plates. His microscopes could magnify around 50–300 times. It is believed that he may have illuminated his liquid specimens by placing them between two pieces of glass and shining light on them at 45-degree angle to the specimen plane. This would have provided a form of dark-field illumination and made bacteria clearly visible. In 1673, Leeuwenhoek sent detailed letters describing his discoveries to the Royal Society of London. It is clear from his descriptions that he saw both bacteria and protozoa. But he did not evaluate these organisms as agents of disease.

## Theory of Spontaneous Generation

There was a considerable controversy surrounding the origin of microbial pathogens. Some proposed that microorganisms originated from nonliving things by spontaneous generation even though larger organisms did not (*theory of spontaneous generation*). They pointed out that boiled extracts of hay or meat would give rise to microorganisms after sometime. Needham (1713–1781) on the basis of his experiments proposed that all organic matter contained a vital force that could confer the property of life to nonliving matter.

## Louis Pasteur: Father of Microbiology

Louis Pasteur, French Microbiologist, is known as the father of medical microbiology for his immense contributions to the field of medical microbiology. He first coined the term “microbiology” for the study of organisms of microscopic size. Many of his important contributions are discussed below.

### ► Germ theory of disease

Many other scientists have contributed to the theory of spontaneous generation with their experiments, but it was Louis Pasteur (1822–1895) who settled it once for all. Pasteur first filtered air through cotton and found that objects resembling plant spores had been trapped. If a piece of cotton was placed in a sterile medium after air had been filtered through it, microbial growth appeared. Next he placed nutrient solutions in flasks, heated their necks in a flame, and drew them out into a variety of curves, while keeping the ends of the necks open to the atmosphere. Pasteur then boiled the solutions for a few minutes and allowed them to cool. No growth took place even though the contents of the flasks were exposed to the air. Pasteur pointed out that no growth occurred because dust and germs had been trapped on the walls of the curved necks. If the necks were broken, growth commenced immediately. By this Pasteur proved that all life even microbes arose only from their

like and not *de novo* (*germ theory of disease*). Pasteur had not only resolved the controversy by 1861 but also had shown how to keep solutions sterile.

Support for the germ theory of disease began to accumulate in the early nineteenth century. Agostino Bassi (1773–1856) first showed that a microorganism could cause disease when he demonstrated in 1835 that the silkworm disease was due to a fungal infection. He also suggested that many diseases were due to microbial infections. In 1845, MJ Berkeley proved that the great potato blight of Ireland was caused by a fungus.

### ► Pasteurization

Pasteur for the first time demonstrated that he could kill many microorganisms in wine by heating and then rapidly cooling the wine, a process now called *pasteurization*. While developing methods for culturing microorganisms in special liquid broths, Pasteur discovered that some microorganisms require air, specifically oxygen, while others are active only in the absence of oxygen. He called these organisms as aerobic and anaerobic organisms, respectively.

### ► Vaccination

In 1877, Pasteur studied anthrax, a disease mainly of cattle and sheep. He developed a vaccine using a weakened strain of the anthrax bacillus, *Bacillus anthracis*. He attenuated the culture of anthrax bacillus by incubation at high temperature of 42–43°C and inoculated the attenuated bacilli in the animals. He demonstrated that animals receiving inoculation of such attenuated strains developed specific protection against anthrax. The success of this concept of immunization was demonstrated by a public experiment on a farm at Pouilly-le-Fort in the year 1881. In that public demonstration, he vaccinated sheeps, goats, and cows with anthrax bacillus attenuated strains, but equal numbers of these animals were nonvaccinated. All the vaccinated as well as nonvaccinated animals were subsequently challenged with a virulent anthrax bacillus culture, after which only the vaccinated animals survived whereas nonvaccinated group of animals died of anthrax.

In 1885, he also developed the first vaccine against rabies in humans that saved millions of human life worldwide. Pasteur coined the term “vaccine” to commemorate Edward Jenner who used such preparations for protection against smallpox. The Pasteur Institute, Paris and subsequently similar institutions were established in many countries of the world for the preparation of vaccines and for the study of infectious diseases.

### ► Control of silkworm disease

Following his successes with the study of fermentation, Pasteur was asked by the French government to investigate the cause of pébrine disease of silkworms that was disrupting the silk industry. After several years of work, he showed that the disease was due to a protozoan parasite. The disease was controlled by raising caterpillars from eggs produced by healthy moths.

## Joseph Lister: The Pioneer of Antiseptics

Indirect evidence that microorganisms are the agents of human disease came from the work of an English surgeon Joseph Lister (1827–1912) on the prevention of wound infections. Lister, impressed with Pasteur's studies on the involvement of microorganisms in fermentation and putrefaction, developed a system of antiseptic surgery designed to prevent microorganisms from entering wounds. Instruments were heat sterilized and phenol was used on surgical dressings and at times sprayed over the surgical area. The approach was remarkably successful and transformed surgery after Lister published his findings in 1867. It also provided strong indirect evidence for the role of microorganisms in disease because phenol, which killed bacteria, also prevented wound infections.

## Robert Koch: The Founder of Koch's Postulates

The first direct demonstration of the role of bacteria in causing disease came from the study of anthrax by the German physician Robert Koch (1843–1910). Koch used the criteria proposed by his former teacher, Jacob Henle (1809–1885), to establish the relationship between *B. anthracis* and anthrax, and he published

his findings in 1876 briefly describing the scientific method he followed. In this experiment, Koch injected healthy mice with a material from diseased animals, and the mice became ill. After transferring anthrax by inoculation through a series of 20 mice, he incubated a piece of spleen containing the anthrax bacillus in beef serum. The bacilli grew, reproduced, and produced spores. When the isolated bacilli or spores were injected into mice, anthrax developed.

During Koch's studies on bacterial diseases, it became necessary to isolate suspected bacterial pathogens. His criteria for proving the causal relationship between a microorganism and a specific disease are known as Koch's postulates.

### ► Koch's postulates

Koch's postulates (criteria) were useful to prove the claim that a microorganism isolated from a disease was indeed causally related to it. A microorganism was accepted as the causative agent of infectious disease, only when it satisfied all the following criteria (Fig. 1-1):

1. The microorganism must be present in every case of the disease but absent from healthy host.
2. The suspected microorganism must be isolated and grown in a pure culture from lesions of the disease.

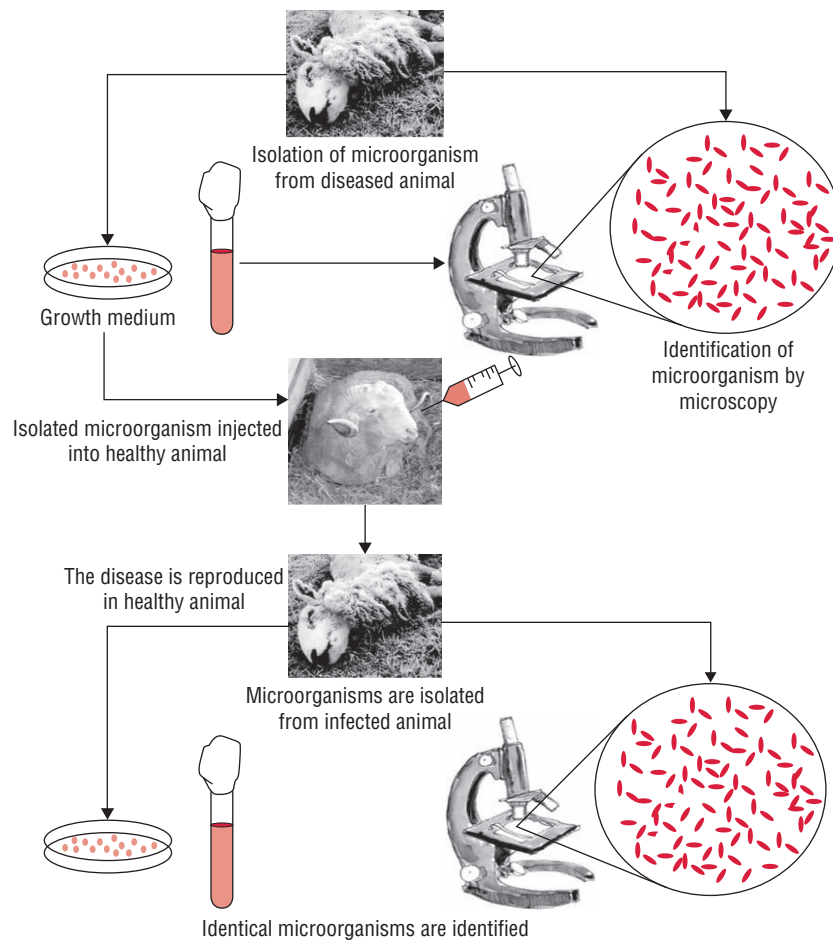

FIG. 1-1. Koch's postulates.

## 6 GENERAL MICROBIOLOGY

- The isolated organism, in pure culture, when inoculated in suitable laboratory animals should produce a similar disease.
- The same microorganism must be isolated again in pure culture from the lesions produced in experimental animals.

The specific antibodies to the bacterium should be demonstrable in the serum of patient suffering from the disease. This was an additional criterion that was introduced subsequently.

Most of the human bacterial pathogens satisfy Koch's postulates except for those of *Mycobacterium leprae* and *Treponema pallidum*, the causative agent of leprosy and syphilis, respectively. Both these bacteria are yet to be grown in cell-free culture media.

### ► Solid medium for culture of bacteria

Koch pioneered the use of agar as a base for culture media. He developed the pour plate method and was the first to use solid culture media for culture of bacteria. This development made possible the isolation of pure cultures that contained only one type of bacterium and directly stimulated progress in all areas of bacteriology. Koch also developed media suitable for growing bacteria isolated from the body. Because of their similarity to body fluids, meat extracts and protein digests were used as nutrient sources. The result was the development of nutrient broth and nutrient agar media that are still in wide use today. By 1882, Koch had used these techniques to isolate the bacillus that caused tuberculosis in humans. Koch also discovered that cholera was caused by *Vibrio cholerae*. He invented the hot air oven and steam sterilizer, and also introduced methods to find out the efficacy of antiseptics. There followed a golden age of about 30–40 years in which most of the major bacterial pathogens were isolated.

### ► Koch's phenomenon

Koch's phenomenon is a hypersensitivity reaction against tuberculosis bacilli demonstrated in guinea pigs. This was first demonstrated by Koch, who showed that guinea pigs already infected with tubercle bacillus, on challenge with tubercle bacillus or its protein, developed an exaggerated inflammatory response.

## Self-Experimentation Studies

To study diseases in a more elaborate and controlled fashion, there were a few dedicated researchers who went to the extremes of self-experimentation. The discovery that hookworm infestation spread by fecal–oral route was first demonstrated by Arthur Loos in 1898. This was known during his attempts at studying *Strongyloides stercoralis* by swallowing its larvae and accidentally swallowing a fecal inoculum with hookworm eggs instead!

These attempts did not always have happy and productive endings as is illustrated by the case of Daniel Carrion

TABLE 1-1

### Discovery of important bacterial agents causing human diseases

Scientist	Bacteria	Year
Hansen	<i>Mycobacterium leprae</i>	1874
Koch	<i>Bacillus anthracis</i>	1876
Neisser	<i>Neisseria gonorrhoeae</i>	1879
Ogston	<i>Staphylococcus aureus</i>	1880
Loeffler	<i>Corynebacterium diphtheriae</i>	1884
Fraenkel	<i>Streptococcus pneumoniae</i>	1886
Weichselbaum	<i>Neisseria meningitidis</i>	1887
Bruce	<i>Brucella melitensis</i>	1887
Kitasato	<i>Clostridium tetani</i>	1889
Yersin	<i>Yersinia pestis</i>	1890

(1858–1895), a medical student in Lima, Peru. He managed to prove that the same organism (later identified to be *Bartonella bacilliformis*) caused a chronic skin lesion called *verruca peruana* and another serious disease called *Oroya fever*. This he did by inoculating himself with material from the warts of the skin lesion. He did develop Oroya fever as he had hypothesized, but the experiment costed him his life when he succumbed to the disease. In the subsequent 50 years, numerous microorganisms were identified as the causative agents of important human diseases and their discovery elucidated (Table 1-1).

## Study of Viruses

In 1892, Dmitri Ivanovsky, a Russian scientist working in St. Petersburg, demonstrated that the sap of leaves infected with tobacco mosaic disease retains its infectious properties even after filtration through Chamberland filter candles. This was an important observation, because it provided an operational definition of viruses and also an experimental technique by which an agent could be considered as a virus.

Beijerinck, a Dutch soil microbiologist, showed that the filtered sap could be diluted and then regain its strength after replication in living and growing tissue of the plant. The agent could reproduce itself (which meant that it was not a toxin) but only in living tissues, not in the cell-free sap of the plant. This explained the failure to culture the pathogen outside its host. All these observations contributed immensely to the discovery of an organism smaller than bacteria (a filterable agent) that is not observable in the light microscope and is able to reproduce itself only in living cells or tissues. Beijerinck called this agent a *contagium vivum fluidum*, or a contagious living liquid.

The concept of *contagium vivum fluidum* or a contagious living liquid began a 25-year debate about the nature of viruses; whether they were liquids or particles? This conflict was laid to rest when d'Herelle developed the plaque assay in 1917 and subsequent development of electron microscopy by

Ruska (1934), when the first electron micrographs of tobacco mosaic virus (TMV) were taken in 1939. The viruses were accepted as particles.

Loeffler and Frosch (1898) described and isolated the first filterable agent from animals, the foot-and-mouth disease virus of cattle. Walter Reed and his team in Cuba (1902) recognized the first human filterable virus, yellow fever virus. Landsteiner and Popper (1909) demonstrated that poliomyelitis was caused by a filterable virus and also successfully transmitted the infection to monkeys. Goodpasture (1930) used chick embryos for cultivation of viruses.

The term *virus* (taken from the Latin for *slimy liquid* or *poison*) was at that time used interchangeably for any infectious agent and so was applied to TMV and then further to all agents of the class.

## d'Herelle and Twort: Founders of the Principles of Modern Virology

Twort and d'Herelle (1915) independently observed a lytic phenomenon in bacterial cultures, which they attributed to viruses. d'Herelle named these viruses as *bacteriophages*. He developed the use of limiting dilutions with the plaque assay to titer the virus preparation. He suggested that the appearance of plaques in the plaque assay show the viruses to be particulate, or corpuscular.

d'Herelle also demonstrated that the attachment (adsorption) of the virus to the host cell is the first step in the pathogenesis of a virus infection. The attachment of a virus occurred only when bacteria sensitive to the virus were mixed with it, demonstrating the host range specificity of a virus at the adsorption step. He described the process of cell lysis and subsequently the release of infectious virus particles. He developed many other techniques that are still used in virology. d'Herelle was in many ways one of the founders of the principles of modern virology.

## Phenomenon of Immunity

The earliest written reference to the phenomenon of immunity can be traced back to Thucydides, the great historian of the Peloponnesian War. Describing a plague in Athens, in 430 BC, he wrote that only those who had recovered from the plague could nurse the sick because they would not contract the disease a second time.

The earliest known smallpox inoculation took place in China, perhaps as early as the fifth century AD. The Chinese method was reported to the Royal Society by an English merchant, John Lister, during early 1900s. A Jesuit priest, Father d'Entrecolles, provided details of the method, which he said was to collect scabs from the pustules and blow a powder made from them into an infant's nose. The scabs or a thread coated with the pus could be stored, but the operation was usually done face-to-face with a sick patient. The same method was used in Japan beginning in 1747. In precolonial India, a *tika* or dot would be made on a child, usually on the sole of the

foot, by traditional *tikadars* who were invited into home (this professional niche was later blacklisted by colonial-era medical practitioners).

The method was significantly improved by the English physician Edward Jenner in 1798. Jenner was intrigued by the fact that milkmaids who had contracted the mild disease cowpox were subsequently immune to smallpox, a disfiguring and often fatal disease. He believed that introducing fluid from a cowpox pustule into people (i.e., inoculating them) might protect them from smallpox. To test this idea, he inoculated an 8-year-old boy with fluid from a cowpox pustule and later intentionally infected the child with smallpox. As predicted, the child did not develop smallpox. Pasteur followed this up with development of vaccines for chicken cholera, anthrax, and rabies. Although Pasteur proved that vaccination worked, but he did not understand how.

## Mechanisms of Immunity

The experimental work of Emil von Behring and Shibasaburo Kitasato in 1890 gave the first insight into the mechanism of immunity. They demonstrated that serum contained elements that protected against infections thus laying the foundation for the identification of humoral immunity. In recognition of this work, von Behring received the Nobel Prize in Medicine in 1901.

In 1884, even before the discovery that a serum component could transfer immunity, Elie Metchnikoff demonstrated that cells also contribute to the immune state of an animal. He observed that certain white blood cells, which he termed *phagocytes*, were able to ingest (phagocytose) microorganisms and other foreign material. Noting that these phagocytic cells were more active in animals that had been immunized, Metchnikoff hypothesized that cells, rather than serum components, were the major effector of immunity. The active phagocytic cells identified by Metchnikoff were most likely blood monocytes and neutrophils.

## Specificity of the Antibody Molecule

One of the greatest enigmas facing early immunologists was the specificity of the antibody molecule for foreign material or antigen. Following theories were proposed to explain this mechanism of specificity:

1. **The selective theory:** The earliest conception of the selective theory dates to Paul Ehrlich in 1900. In the 1930s and 1940s, the selective theory was challenged by various instructional theories, in which antigen played a central role in determining the specificity of the antibody molecule.
2. **The instructional theory:** According to the instructional theories, a particular antigen would serve as a template around which the antibody would fold. This concept was first postulated by Friedrich Breinl and Felix Haurowitz in the 1930s and redefined in the 1940s in terms of protein folding by Linus Pauling.

## 8 GENERAL MICROBIOLOGY

3. **The clonal selection theory:** The instructional theories were formally disproved in the 1960s, during which information was beginning to appear regarding the structure of DNA, RNA, and protein. These information offered new insights into the vexing problem of how an individual could make antibodies against almost anything. In the 1950s, selective theories resurfaced as a result of new experimental data and through the pioneering contributions of Niels Jerne, David Talmadge, and F Macfarlane Burnet, who refined into a theory that came to be known as the *clonal selection theory*.

## Chemotherapeutic Agents

Until the 1930s, there had been no chemical treatment available to fight bacterial infections in general. Prevention was the main means of protecting patients, and an obsession with the threat of germs and the moral responsibility to avoid infection was deeply instilled in Western cultures. At the same time, there were repeated hopes for a wonder drug. Louis Pasteur's pupil Paul Vuillemin coined the term "*antibiosis*" in 1889 to denote a process by which life could be used to destroy life.

Paul Ehrlich was an exceptionally gifted histological chemist and invented the precursor technique to Gram-staining of bacteria. He demonstrated that dyes react specifically with various components of blood cells and the cells of other tissues. He began to test the dyes for therapeutic properties to determine whether they could kill the pathogenic microbes. He developed *Salvarsan*, an arsenical compound in 1909. The compound known as "*magic bullet*" was capable of destroying *T. pallidum*, the causative agent of syphilis. This treatment proved effective against syphilis. This work was of epochal importance, stimulating research that led to the development of sulfa drugs, penicillin, and other antibiotics. He, therefore, is known as the father of chemotherapy.

## Antibiotics

The word "*antibiotic*" did not follow immediately, but the drug pyocyanase, a weakly effective antibiotic, was marketed from

the late nineteenth century into the 1930s. Early in the 1920s, there was an excitement about the potential of the newly identified phage viruses to kill bacteria. The discovery of an antibacterial factor in the exudates of the fungus *Penicillium* by Sir Alexander Fleming at St. Mary's Hospital in 1928 was therefore not totally unexpected. He accidentally discovered that a substance produced by the fungus destroyed the pyogenic bacteria, *staphylococci*. This initiated the beginning of the antibiotics era. Other similar antibiotics were discovered in rapid succession. The sulfonamide drugs discovered subsequently offered cures for a wide range of bacterial infections.

Introduction of antibiotics in medicine raised a lot of expectations among both doctors and patients. Certain terrifying infectious diseases (e.g., rheumatic fever, syphilis, pneumonia, tuberculosis) and unpleasant skin conditions (e.g., carbuncles) became easily treatable, and their disappearance appeared to be certain. Surgeons could risk more dangerous operations and the use of drugs that compromised immune systems. Patients who had once turned to many kinds of alternative medicine, or refused treatment, now entrusted themselves to antibiotics.

Medical uses of antibiotics on human patients were harder to limit—even though, from the 1940s, the fear that public enthusiasm would promote the selection of resistant strains did lead—to some constraints. In Britain, the Penicillin Act of 1948 was explicitly intended to, for the first time, limit through prescription the public's access to a drug that was not a poison. Nonetheless, during the 1950s, a penicillin-resistant strain of *staphylococcus aureus* termed 80/81 infected hospitals and maternity wards across the world. Newborn babies in hospital crèches were infected and postoperative infections proved common.

By the late 1990s, although many variants of older drugs had been produced, new families of antibiotics were, however, not being discovered. However, a sustained effort is now being made to develop more effective antibiotics to treat a wide range of infections.

The field of medical microbiology has been enriched by contributions of many eminent microbiologists both in the past and in the recent times. The work of many of them has been recognized worldwide by the award of Nobel Prizes (Table 1-2).

**TABLE 1-2** List of recent Nobel Prize winners

Year	Name/Names of scientists	Research done
1993	Kary Mullis	Polymerase chain reaction
1996	Peter C Doherty and Rolf M Zinkernagel	Cell-mediated immune defenses
1997	Stanley B Prusiner	Prion discovery
2005	Barry J Marshall, J Robin Warren	Discovery of <i>Helicobacter pylori</i> and its role in gastritis and peptic ulcer disease
2008	Herald Zur Hausen	Discovery of Human Papilloma viruses causing cervical cancer
2008	Francoise Barre Sinoussi, Luc Montagnier	Discovery of Human immunodeficiency virus
2011	Ralph M. Steinman	Discovery of dendritic cell and its role in adaptive immune response
2011	Bruce A. Beutler, Jules A. Hoffmann	Discoveries concerning activation of innate immunity



# Morphology and Physiology of Bacteria

## Introduction

All living beings can be classified into three kingdoms: *Plant*, *Animal*, and *Protista*. Microorganisms are a heterogeneous group of several distinct living structures of microscopic size, classified under the kingdom Protista. The kingdom Protista includes unicellular organisms, such as bacteria, fungi, protozoa, and algae. Based on the differences in cellular organization and biochemistry, the kingdom Protista has been divided into three groups: prokaryotes, eukaryotes, and the most recently described archaeobacteria.

- 1. Prokaryotes:** Bacteria and blue green algae are prokaryotes. Bacteria are unicellular free living organisms having both DNA and RNA. They are capable of performing all essential processes of life, e.g., growth, reproduction, and metabolism. They do not show any true branching except Actinomycetales, the higher bacteria. Bacteria lack chlorophyll unlike blue green algae, which contain chlorophyll.
- 2. Eukaryotes:** Fungi, algae other than blue green, protozoa, and slime moulds are eukaryotes.
- 3. Archaeobacteria:** These are more closely related to eukaryotes than prokaryotes. They however do not include any human pathogens.

Differences between prokaryotes and eukaryotes have been summarized in Table 2-1.

## Size of Bacteria

Bacteria are microscopic and very small in size. The size of bacteria is measured in units of length called microns. A micron (micrometer,  $\mu\text{m}$ ) is the unit of measurement used in bacteriology.

- 1 micron ( $\mu\text{m}$ ) = 1/1000 millimeter (mm).
- 1 nanometer (nm) = 1/1000 micron ( $\mu\text{m}$ ).
- 1 Angstrom unit ( $\text{A}^\circ$ ) = 1/10 nm (nanometer).

Bacteria of medical importance measure 2–5  $\mu\text{m}$  (length)  $\times$  0.2–1.5  $\mu\text{m}$  (width).

## Microscopy

Microscopy is an important component of diagnostic microbiology. Bacteria being very small cannot be visualized by the

naked eye, because the limit of resolution with the unaided eye is about 200 microns. So, the study of bacteria requires the use of microscopes. A **microscope** is an instrument that uses one or more lenses to produce a magnified image of an object that is invisible to the unaided eye.

## Types of Microscopy

The following types of microscopy are used for the examination of microorganisms including bacteria:

### ► Light microscopy

Light microscopy, as the name suggests, uses natural or artificial transmitted light as the source of light. Resolving power of microscope is an important component of light microscopy. It is the ability of the lens system to distinguish two closely placed objects as distinct and separate entities. It is dependent on the wavelength of light used to illuminate the object and on the numerical aperture of the microscope. It is about half of the wavelength of light being used. For example, the smallest particle which can be resolved by yellow light with a wavelength of 0.4  $\mu\text{m}$  is about 0.2  $\mu\text{m}$ . Proper use of condenser that focuses light on the plane of the object facilitates optimization of the resolving power of the microscope. Resolving power of the microscope is enhanced further by adjusting the medium through which light passes between the object and objective lens. The use of *immersion oil*, whose refractive index is similar to that of the glass, improves the resolution of the microscope. The numerical aperture of the microscope is defined as the light gathering power of the microscope. Different types of light microscopy include (a) bright-field microscopy, (b) dark-ground microscopy, (c) phase-contrast microscopy, and (d) interference microscopy.

**1. Bright-field microscopy:** Bright-field microscopy (always referred to as ordinary light microscopy) is the most common form of light microscopy that uses a compound light microscope. A compound light microscope primarily consists of a compound lens system that contains a number of objective lenses, such as lenses of low power ( $\times 10$ ), high power ( $\times 40$ ), and oil immersion ( $\times 100$ ). It also contains a fixed ocular (eye piece) lens, usually of  $\times 10$  or  $\times 5$ . Final magnification of an object is the multiplication of lens power of the objective with that of the eye piece (Fig. 2-1). The bright-field microscopy has many uses.

TABLE 2-1

## Differences between prokaryotic and eukaryotic cells

Structure	Prokaryotes	Eukaryotes
<b>Nucleus</b>		
Nuclear membrane	Absent	Present
Nucleolus	Absent	Present
Chromosome	One, circular	More than one, linear
Location	Free in the cytoplasm, attached to mesosomes	Contained in membrane bound structure
Replication	Binary fission	Mitotic division
Extrachromosomal DNA	Plasmid	Inside the mitochondria
<b>Cytoplasm</b>		
Cytoplasmic organelles like mitochondria, Golgi apparatus, and endoplasmic reticulum	Absent	Present
Cytoplasmic streaming	Absent	Present
Lysosomes	Absent	Present
Ribosomes—protein production site	70S (50S + 30S), free in cytoplasm or bound to cell membrane	80S (60S + 40S), attached to rough endoplasmic reticulum
<b>Chemical composition</b>		
Cell wall	Present	Absent, except for fungi that have chitinous cell wall
Sterols	Absent	Present
Muramic acid	Present	Absent
Energy production site	Electron transport chain located in the cell membrane	Within membrane bound mitochondria

- It may be used to examine either wet films or “hanging drop” for demonstration of the motility of flagellated bacteria (e.g., *Escherichia coli*, *Pseudomonas aeruginosa*, etc.) and protozoa (e.g., *Trichomonas vaginalis*, *Giardia intestinalis*, etc.). The wet preparation is also useful for demonstration of microorganisms in urine or feces, and also for detection of fungi in the skin.
- It is useful for demonstration of the structural details.
- It is also useful for measuring approximate size of the bacteria, fungi, and protozoa in stained preparations.

**2. Dark-ground microscopy:** The dark-ground microscope makes use of dark-ground microscope, a special type of compound light microscope. The dark-field condenser with a central circular stop, which illuminates the object with a cone of light, is the most essential part of the dark-ground microscope. This microscope uses reflected light instead of transmitted light used in the ordinary light microscope (Fig. 2-2). It prevents light from falling directly on the objective lens. Light rays falling on the object are reflected or scattered onto the objective lens with the result that the microorganisms

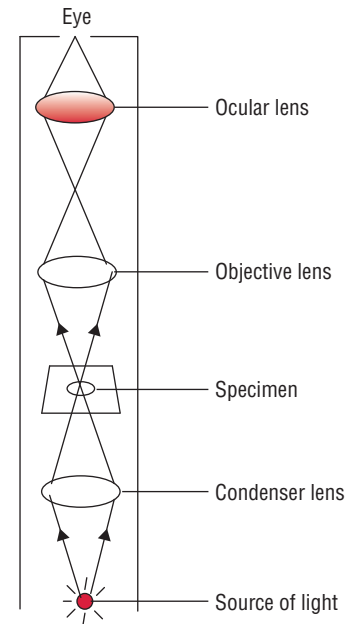

FIG. 2-1. Principle of compound light microscope.

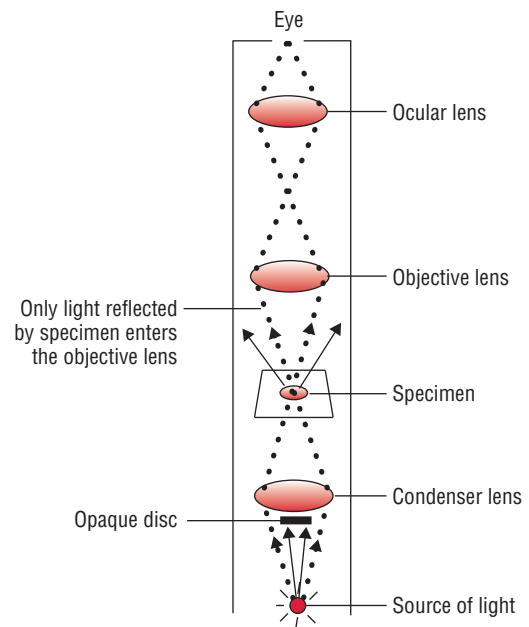

FIG. 2-2. Principle of dark-ground microscopy.

appear brightly stained against a dark background. The dark-ground microscopy has following uses:

- It is useful for demonstration of very thin bacteria (such as, spirochetes) not visible under ordinary illumination, since the reflection of the light makes them appear larger. This is a frequently used method for rapid demonstration of *Treponema pallidum* in clinical specimens.
- It is also useful for demonstration of motility of flagellated bacteria and protozoa.

**3. Phase-contrast microscopy:** Phase-contrast microscopy makes use of a specific optical system that converts differences

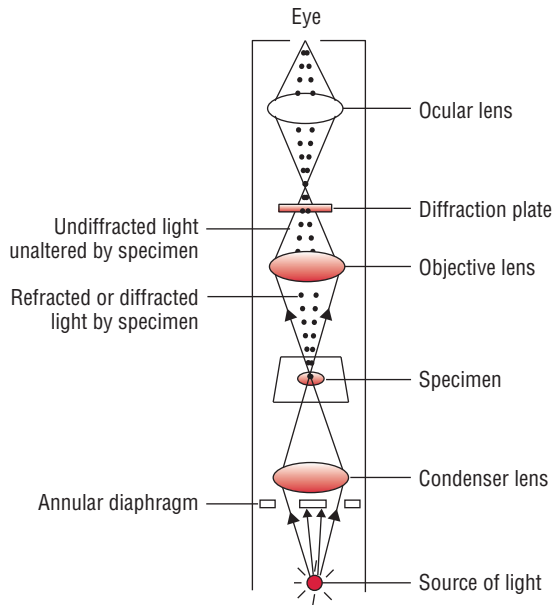

FIG. 2-3. Principle of phase-contrast microscopy.

in phase in an organism into differences in intensity of light thereby producing light and dark contrast in the image (Fig. 2-3).

The optical system includes a special condenser and objective lens which can be fitted to an ordinary light microscope to convert it into a phase-contrast microscope. The phase-contrast microscopy has following uses:

- It is immensely useful for examination of living microorganisms particularly protozoa (e.g., *T. vaginalis*, *Entamoeba histolytica*, etc.)
- It is useful for examining the internal structures of a living cell by improving the contrast and differentiating structures within the cell that differs in their thickness and refractive index.

**4. Interference microscopy:** This is another specialized application of light microscopy used for demonstrating cell organelles. It is also useful for quantitative measurement of the chemical constituents of the cells, such as proteins, lipids, and nucleic acids.

### ► Fluorescence microscopy

Fluorescence microscopy is based on the principle that the specimens stained with fluorescent dye when exposed to ultraviolet light result in emission of longer wavelength of light (i.e., visible light) (Fig. 2-4). The bacteria stained with fluorescent dye appear as a brightly glowing object against a dark background.

Fluorescence microscopy needs a fluorescence microscope fitted with an ultraviolet light source. Auramine O, acridine orange, and rhodamine are fluorescent dyes used to visualize bacteria. The resolving power of a fluorescence microscope is increased due to the short wavelength of ultraviolet light. Auramine O, acridine orange, and rhodamine are fluorescent dyes used to visualize bacteria. Fluorescence microscopy is widely used in diagnostic microbiology in the following ways:

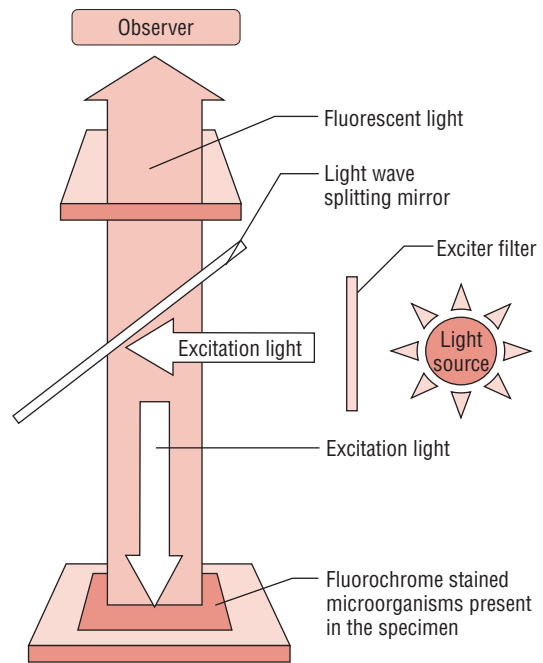

FIG. 2-4. Principle of fluorescence microscopy.

- It is used for direct demonstration of antigen of a pathogen in clinical specimens by direct fluorescent antibody test (e.g., direct detection of *Neisseria gonorrhoeae*, *Corynebacterium diphtheriae*, etc. directly in clinical specimens).
- It is also used for the estimation of antibodies in the serum by indirect fluorescent antibody test (IFA) (e.g., IFA in leptospirosis, syphilis, brucellosis, etc.).

### ► Electron microscopy

Electron microscopy utilizes a beam of electrons instead of a beam of light used in the light microscopy. The electron beam is focused by electromagnets, analogous to the lenses used in the light microscopy. The object to be examined is kept on the path of the beam that scatters the electrons and produces an image which is focused on a screen (Fig. 2-5).

The resolving power of the electron microscope is extremely high, theoretically 100,000 times than that of a light microscope. This is because the electron microscope uses electrons whose wavelength is approximately 0.005 nm as compared to 5000 nm wavelength of the visible light. As mentioned earlier, the resolving power is half of the wavelength. In practice, the resolving power of the electron microscope, however, is about 0.1 nm. There have been many developments in electron microscopy that include (a) shadow casting, (b) scanning electron microscopy, (c) immunoelectron microscopy, and (d) freeze-etching, etc.

- **Shadow casting** is an important technique that is carried out by depositing a thin layer of platinum or other metal on the microorganism to be examined. This platinum-coated organism, on bombardment with electron beams, scatters the electron and produces an image that is focused on a fluorescent screen.

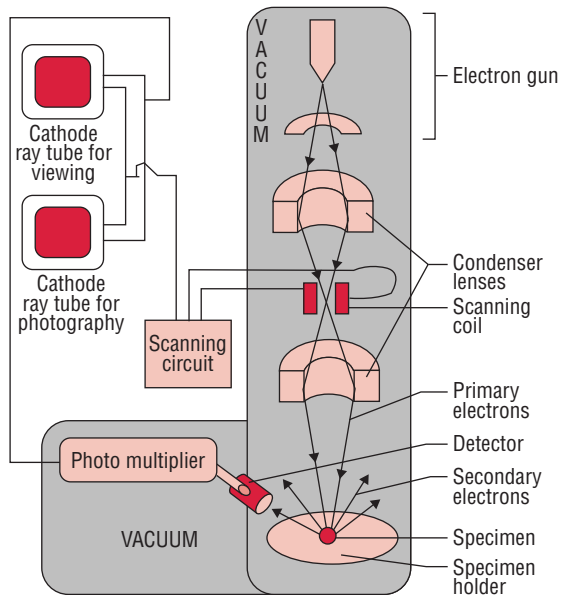

FIG. 2-5. Principle of electron microscopy.

- **Scanning electron microscopy** is another development that provides a three-dimensional image of the object as well as high resolution.
- **Immunoelectron microscopy** is a method to enhance sensitivity and specificity by reacting the specimen with specific antiviral antibody that results in clumping of viral particles. In this method also, antibody may be conjugated with gold to visualize and determine the location of specific antigenic determinants in a specimen.
- **Freeze-etching** is the method by which live organisms can be visualized unlike in traditional methods of electron microscopy in which living cells cannot be examined. This method is useful for the study of cellular ultrastructure of the microorganisms in the living state. This method is based on rapid cooling of specimens by deep-freezing in liquid gas and the subsequent formation of carbon platinum replica of the specimen.

Electron microscope is widely used for:

- Rapid detection of viruses directly in clinical specimens. This is especially useful for detection of noncultivable viruses.
- Ultrastructural study of various microorganisms.

Differences between electron microscope and light microscope are summarized in Table 2-2.

### ► Newer microscopic methods

These include the following:

- **Confocal microscopy:** This is useful to obtain high resolution images and for three dimensional reconstruction of biological models.
- **Scanning probe microscopy:** This measures surface features by moving a sharp probe over the object's surface. There are two types of scanning probe microscope: (a) scanning tunneling microscope and (b) atomic force microscope.

TABLE 2-2

### Differences between electron microscope and light microscope

Characteristics	Light microscope	Electron microscope
Source	Visible light	Electron beam
Medium of transmission	Air	High vacuum
Nature of lens	Glass	Electromagnet
Focusing mechanism	Lens position is adjusted mechanically	Current to the magnetic lens is adjusted
Changing the magnification	Switch the objective lens	Adjust the current to the magnetic lens
Source of contrast	Differential light absorption	Scattering of electrons
Specimen mount	Glass slide	Metal grid
Best resolution	0.2 $\mu\text{m}$	0.5 nm
Highest practical magnification	1000-1500	Over 100,000
Affordability	Cheaper	Expensive

## Study of Bacteria

Bacteria can be studied either in unstained (wet mount) or stained preparation.

- The **wet mount preparation** is useful for demonstration of motility of bacteria by light microscopy or demonstration of spirochetes by dark-ground microscopy.
- **Stained preparations** are used to demonstrate structural details of the bacteria by producing color contrast.

## Staining Methods

The common staining techniques used in diagnostic microbiology are discussed below:

### ► Simple stains

Methylene blue and basic fuchsin are the simple stains that provide color contrast but impart the same color to all the bacteria in a smear.

### ► Negative staining

Bacteria are mixed with dyes, such as Indian ink that produces a uniform dark-colored background against which the unstained organisms stand out in contrast. This is used for demonstration of bacterial capsule that are usually not stained by simple stains. India Ink method for demonstration of the fungus *Cryptococcus neoformans* is a common example.

### ► Impregnation stains

Cells and structures that are too thin to be visualized by the light microscope can be rendered visible by impregnation of silver on their surface. Silver impregnation method is a common method used for staining spirochetes, such as *T. pallidum*, *Leptospira*, *Borrelia*, etc.

## ► Differential stains

Differential stains impart different colors to different bacteria or different bacterial structures. The commonly used differential stains include Gram stain, acid-fast stain, and Albert's stain.

**Gram stain:** Gram stain was devised by Christian Gram, a Danish microbiologist, in 1884, as a convenient method for classifying bacteria. The Gram staining method essentially consists of four steps:

- (i) *Primary staining* with basic dyes, such as methyl violet, crystal violet, etc.
- (ii) *Application of mordant* in the form of dilute solution of iodine.
- (iii) *Decolorization* with ethanol, acetone, or aniline.
- (iv) *Counterstaining* with acidic dyes, such as carbol fuchsin, safranin, or neutral red.

### Key Points

Gram staining is an essential procedure that is used in the identification of bacteria. The stain differentiates bacteria into two broad groups:

- **Gram-positive** bacteria are those that resist decolorization and retain the primary dye-iodine complex, appearing violet. They have a relatively thick amorphous wall and more acidic protoplasm which are believed to retain the basic violet dye and iodine complex within the cell.
- **Gram-negative** bacteria are decolorized by organic solvents and take counterstain, appearing red. The decolorizing agent, such as acetone or ethanol, used during staining disrupts this membranous envelope, and the dye and iodine complex is washed out of Gram-negative bacteria.

There are certain groups of bacteria, such as *Mycobacterium tuberculosis* and *Mycobacterium leprae*, that cannot be considered typical Gram-negative or Gram-positive bacteria. This is because these bacteria either do not take up the Gram stain or they have a different type of envelope. These mycobacteria possess a waxy envelope containing complex glycolipids that make them impervious to the Gram stain. Gram stain also provides useful information on the structure of bacterial cell envelope.

**Acid-fast stain:** The acid-fast stain was discovered by Ehrlich, who found that after staining with aniline dyes, tubercle bacilli resist decolorization with acid. The method, subsequently, was modified by Ziehl and Neelsen, hence is widely known as Ziehl-Neelsen (ZN) stain.

### Key Points

Acid fast staining method consists of following methods:

- Fixed smears are first stained by a strong carbol fuchsin with the application of heat. Heating facilitates entry of phenolic carbol fuchsin stain into the bacteria.
- It is then decolorized with 5–20% (depending on the bacteria to be stained) sulfuric acid.
- It is then counterstained with a contrasting dye, such as methylene blue. The acid-fast bacilli (AFB) retain the red color of carbol fuchsin and appear bright red in stained smears. Pus cells and epithelial cells present in the smear, on other hand, take up the blue color of the counterstain and appear blue.

Acid fastness is due to the (a) high content of lipids, fatty acids, components of mycolic acid, and (b) higher alcohols found in the cell wall of the *Mycobacterium*. Acid fastness also depends on integrity of the cell wall. The ZN smear is best used for staining:

- *M. tuberculosis*, *M. leprae*, *Nocardia*, *Actinomyces*, and
- Oocysts of intestinal coccidian parasites (such as *Cryptosporidium*, *Cyclospora*, *Isospora*, etc.).

**Albert's stain:** Albert's stain is used for staining the volutin granules of *C. diphtheriae*. These granules have an affinity for basic dyes and are called metachromatic granules. These granules are stained bluish-black against green protoplasm on staining by Albert's stain.

## Shape of Bacteria

Depending on their shape, bacteria are classified into several types (Fig. 2-6):

1. **Cocci:** The cocci (*kokkos*, berry) are oval or spherical cells. These may be arranged in pairs (e.g., pneumococci, meningococci, and gonococci), tetrads (micrococci), chains (e.g., streptococci), and clusters (e.g., staphylococci).
2. **Bacilli:** The bacilli (*bacillus*, rod) are rod shaped. These bacilli may show either of the following arrangement:
  - (a) *Coccobacilli:* Length of the bacteria is approximately the same as its width, e.g., *Brucella*.
  - (b) *Streptobacilli:* These are arranged in chains, e.g., *Streptobacillus*.
  - (c) *Comma shaped:* They exhibit curved appearance, e.g., *Vibrio*.
  - (d) *Spirilla:* They exhibit rigid spiral forms, e.g., *Spirillum*.
3. **Spirochetes:** Spirochetes (*spira*, coil; *chaite*, hair) are slender, flexuous spiral forms, e.g., *Treponema*.
4. **Actinomycetes:** Actinomycetes (*actin*, ray; *mykes*, fungus) are branching filamentous bacteria resembling fungi. They possess a rigid cell wall.

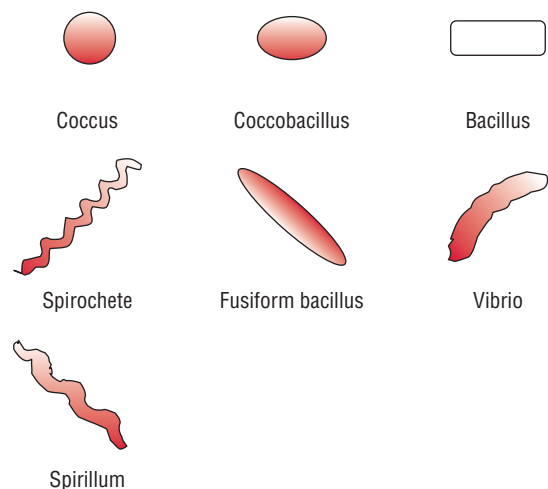

FIG. 2-6. Different morphological types of the bacteria.

## Structure and Functions of Bacterial Cell Envelope

The outer layer or cell envelope provides a structural and physiological barrier between the protoplasm (inside) of the cell and the external environment. The cell envelope protects bacteria against osmotic lysis and gives bacteria rigidity and shape. The cell envelope primarily consists of two components: a cell wall and cytoplasmic or plasma membrane. It encloses the protoplasm, which consists of (i) cytoplasm, (ii) cytoplasmic inclusions (mesosomes, ribosomes, inclusion granules, vacuoles), and (iii) a single circular DNA (Fig. 2-7).

### Cell Wall

Prokaryotic cells almost always are bounded by a fairly rigid and chemically complex structure present between the cell membrane and capsule/slime layer called the cell wall. Peptidoglycan is the main component of the cell wall and is responsible for the shape and strength of the cell. It is a disaccharide and contains two sugar derivatives—*N*-acetylglucosamine and *N*-acetylmuramic acid—joined together by short peptide chains. *N*-acetylmuramic acid carries a tetrapeptide side chain consisting of D- and L-amino acids (D-glutamic acid and L-alanine) with mesodiaminopimelic acid (Gram-negative bacteria) or L-lysine (Gram-positive bacteria). Tetrapeptide side chains are interconnected by pentaglycine bridges. Most Gram-negative cell walls lack interpeptide bridge. Cell wall provides shape to the cell and protects bacteria from changes in osmotic pressure, which within the bacteria cell measures 5–20 atmospheres.

Bacterial cells can be classified into Gram-positive or Gram-negative based on the structural differences between Gram-positive and Gram-negative cell walls. The cell walls of the Gram-positive bacteria have simpler chemical structures compared to Gram-negative bacteria.

#### ► Gram-positive cell wall

The Gram-positive cell wall is thick (15–80 nm) and more homogenous than that of the thin (2 nm) Gram-negative cell wall. The Gram-positive cell wall contains large amount of peptidoglycan present in several layers that constitutes about 40–80% of dry weight of the cell wall (Fig. 2-8). The Gram-positive

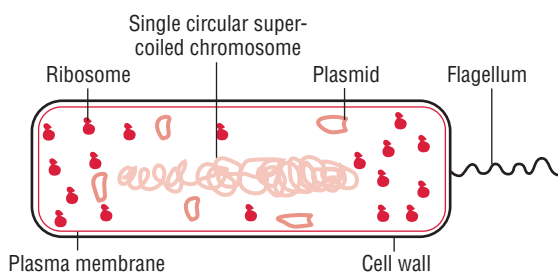

FIG. 2-7. Schematic diagram of structure of a bacteria.

cell wall consists primarily of teichoic and teichuronic acids. These two components account for up to 50% of the dry weight of the wall and 10% of the dry weight of the total cell.

**1. Teichoic acids:** Teichoic acids are polymers of polyribitol phosphate or polyglycerol phosphate containing ribitol and glycerol. These polymers may have sugar or amino acid substitutes, either as side chain or within the chain of polymer. Teichoic acids are of two types—wall teichoic acid (WTA) and lipoteichoic acids (LTA). They are connected to the peptidoglycan by a covalent bond with the six hydroxyl of *N*-acetylmuramic acid in the WTA and to plasma membrane lipids in LTA.

### Key Points

Teichoic acids have many functions:

- They constitute major surface antigens of those Gram-positive species that possess them. In *Streptococcus pneumoniae*, the teichoic acids bear the antigenic determinants called *Forssman antigen*. In *Streptococcus pyogenes*, LTA is associated with the M protein that protrudes from the cell membrane through the peptidoglycan layer. The long M protein molecules together with the LTA form microfibrils that facilitate the attachment of *S. pyogenes* to animal cells;
- They are also used as antigen for serological classification of bacteria;
- They serve as substrates for many autolytic enzymes;
- They bind magnesium ion and may play a role in supply of this ion to the cell;
- They play a role in normal functioning of the cell wall and provide an external permeability barrier to Gram-positive bacteria; and
- Membrane teichoic acid serves to anchor the underlying cell membrane.

**2. Teichuronic acid:** Teichuronic acid consists of repeat units of sugar acids (such as *N*-acetylmannuronic or D-glucuronic acid). They are synthesized in place of teichoic acids when phosphate supply to the cell is limited.

Gram-positive cell wall also contains neutral sugars (such as mannose, arabinose, rhamnose, and glucosamine) and acidic sugars (such as glucuronic acid and mannanuronic acid), which occur as subunits of polysaccharides in the cell wall.

#### ► Gram-negative cell wall

The Gram-negative cell wall is much more complex than the Gram-positive cell wall. Peptidoglycan content in the Gram-negative cell wall is significantly less than the Gram-positive cell wall. Only 1–2 layers of peptidoglycan (2–8 nm) are present just outside the cell membrane. The Gram-negative cell wall outside the peptidoglycan layer contains three main components—(a) lipoprotein layer, (b) outer membrane, and (c) lipopolysaccharides (Fig. 2-9).

**Lipoprotein layer:** The lipoprotein layer is mainly composed of Braun's lipoprotein. Braun's lipoprotein is a small lipoprotein that is covalently joined to the underlying peptidoglycan and embedded in the outer membrane by its hydrophobic end.

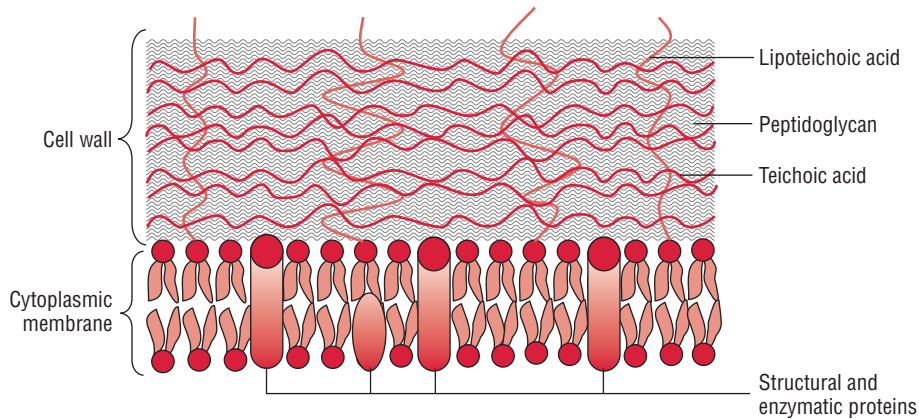

FIG. 2-8. Schematic diagram of the cell wall of the Gram-positive bacteria.

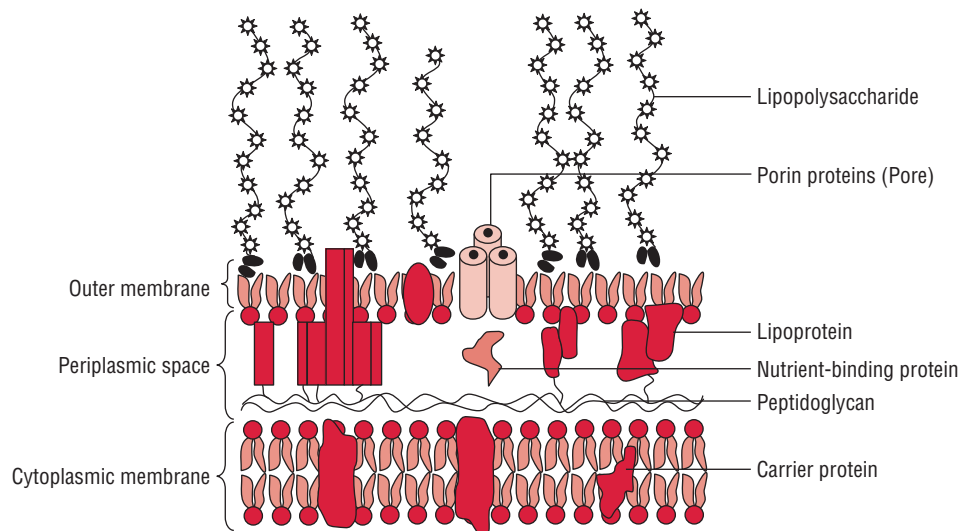

FIG. 2-9. Schematic diagram of the cell wall of the Gram-negative bacteria.

The lipoprotein stabilizes the outer membrane of the Gram-negative cell wall.

**Outer membrane:** The outer membrane is a bilayered structure; its inner part resembles in composition with that of the cell membrane, while its outer part contains a distinctive component called lipopolysaccharide. The outer membrane and plasma membrane appear to be in direct contact at many sites in the Gram-negative wall. The outer membrane has a variety of proteins as follows:

(a) **Porins:** The outer membrane has special channels consisting of protein molecules called porins. These porins have many functions:

- They permit the passive diffusion of low-molecular weight hydrophilic compounds, such as sugars, amino acids, and certain ions;
- They exclude hydrophobic molecules; and
- They serve to protect the cell.

(b) **Outer membrane proteins (OMPs):** These include the following:

- Omp C, D, F, and PhoE&LamB are the four major proteins of the outer membrane that are responsible for most of the transmembrane diffusion of maltose and maltodextrins.
- Tsx, the receptor for T6 bacteriophage, is responsible for the transmembrane diffusion of nucleosides and some amino acids.
- Omp A protein anchors the outer membrane to the peptidoglycan layer. It is also the sex pilus receptor in F-mediated bacterial conjugation.

The outer membrane also contains proteins that are involved in the transport of specific molecules, such as vitamin B<sub>12</sub> and iron-siderophore complexes; it also contains a limited number of minor proteins, such as enzymes, phospholipases, and proteases.

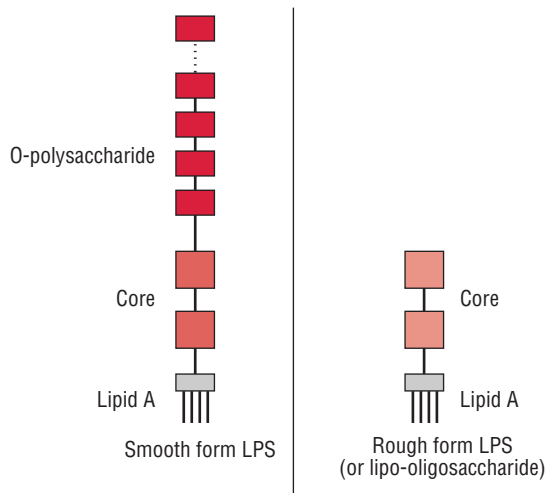

FIG. 2-10. Structure of a lipopolysaccharide.

**Lipopolysaccharides:** Lipopolysaccharides (LPS) are complex molecules present in the outer membrane of the Gram-negative bacteria. Structurally, the LPS consist of three main components—lipid A, the core oligosaccharide, and the O polysaccharide or O-antigen (Fig. 2-10).

- **Lipid A:** This consists of phosphorylated glucosamine disaccharide units, to which a number of long-chain fatty acids are attached. This also consists of hydroxymyristic acid, a unique fatty acid, which is associated with endotoxic activity of the LPS. There is a little variation in the structure of the lipid A among different species of the Gram-negative bacteria. However, it remains the same within the bacteria of the same species.
- **Core oligosaccharide:** The core oligosaccharide includes two characteristic sugars—ketodeoxyoctanoic acid (KDO) and a heptose—both joined together by lipid A. This is genus specific and similar in all Gram-negative bacteria. Lipooligosaccharides (LOS) are smaller glycolipids. They have relatively short, multiantennary (i.e., branched) glycans present in bacteria (e.g., *Neisseria meningitidis*, *N. gonorrhoeae*, *Haemophilus influenzae*, and *Haemophilus ducreyi*) that colonize mucosal surfaces. They exhibit extensive antigenic and structural diversity even within a single strain. LOS is an important virulence factor. Epitopes on LOS have a terminal *N*-acetyllactosamine (Gal(β)1-4-GlcNAc) residue, which is immunochemically similar to the precursor of the human erythrocyte i antigen. Sialylation of the *N*-acetyllactosamine residue *in vivo* provides the organism with the environmental advantages of molecular mimicry of a host antigen and the biologic masking thought to be provided by sialic acids.
- **O polysaccharide or O-antigen:** It is the portion extending outwards from the core. It has several peculiar sugars and varies in composition between bacterial strains, conferring species-specific antigen specificity. It is exposed to host-immune system. Gram-negative bacteria may thwart host defenses by rapidly changing the nature of their O side chains to avoid detection.

TABLE 2-3

### Differences between Gram-positive and Gram-negative bacteria cell wall

Characters	Gram-positive cell wall	Gram-negative cell wall
Thickness	15–80 nm	2 nm
Lipid content	2–5%	15–20%
Teichoic acid	Present	Absent
Variety of amino acid	Few	Several
Aromatic amino acid	Absent	Present
Action as endotoxin	No	Yes
Sulfur-containing amino acid	Absent	Present
Treatment with lysozyme	Protoplast	Spheroplast

Differences between Gram-positive and Gram-negative cell walls are summarized in Table 2-3.

### Periplasmic space

Periplasmic space is a distinct space between cell membrane and outer membrane (innermost layer of Gram-negative cell wall) in Gram-negative bacteria. This space is filled with a loose layer of peptidoglycan matrix. The periplasmic space of Gram-negative bacteria contains many proteins that participate in nutrient acquisition, and many hydrolytic enzymes, beta-lactamases binding proteins, and enzymes that participate in the peptidoglycan synthesis. Polymers of D-glucose, called membrane-derived oligosaccharides, appear to play a role in osmoregulation. The periplasmic space is less distinct in Gram-positive cell walls.

### Cell wall of acid-fast bacilli

The cell wall of acid-fast bacilli, such as *M. tuberculosis*, contains large amounts of waxes known as mycolic acids. The cell wall is composed of peptidoglycan and an outer asymmetric lipid bilayer. The inner lipid bilayer contains mycolic acids linked to an arabinoglycan protein and the outer layer contains other extractable lipids. This hydrophobic structure renders these bacteria resistant to many harsh chemicals including detergents and strong acids. During staining, if dye is introduced into these cells by brief heating or treatment with detergents, they resist decolorization by sulfuric acid or acid alcohol, and are therefore called acid-fast organisms.

### Atypical forms of bacteria

Atypical forms of bacteria include (i) cell wall deficient forms, (ii) pleomorphic bacteria, and (iii) involution forms. Many agents, such as antibiotics, lysozyme, and bacteriophages interfere or inhibit the synthesis of bacterial cell wall components, resulting in the formation of defective bacteria.

**1. Cell wall deficient forms:** The cell wall could be removed by hydrolysis with lysozyme or by blocking peptidoglycan synthesis with an antibiotic such as penicillin. These defective bacteria are believed to play a role in the persistence of pyelonephritis and other chronic infections. Cell wall deficient forms



without cell walls or with deficient cell walls may be of various types, such as—protoplasts, spheroplasts, mycoplasma, and L-forms.

- **Protoplasts:** These are defective unstable forms of bacteria with an intact cytoplasmic membrane but without any cell wall. In hypertonic media, these are produced from Gram-positive cells on treatment with lysozyme.
- **Spheroplasts:** These are defective forms derived from Gram-negative bacteria in the presence of EDTA (ethylenediaminetetraacetic acid). The EDTA disrupts the outer membrane allowing access of lysozyme and resulting in formation of spheroplasts. Spheroplasts are osmotically fragile and still retain outer membrane and entrapped peptidoglycan.
- **Mycoplasma:** These are naturally occurring bacteria without cell wall. They do not possess any definite shape. They are very minute in size measuring 50–300 nm in diameter.
- **L-forms:** This is named after Lister Institute, London, where the abnormal form of *Streptobacillus moniliformis* was first demonstrated. The L-forms do not exhibit any regular size and shape. They may be spherical or disc shaped, about 0.1–20  $\mu\text{m}$  in diameter. They are difficult to cultivate and usually require a medium that is solidified with agar as well as having the right osmotic strength. They are produced more readily with exposure to penicillin than with lysozyme. Some bacterial species produce L-forms spontaneously. L-forms in the host may produce chronic infections and are relatively resistant to antibiotic treatment.

**2. Pleomorphic bacteria:** Pleomorphic bacteria (e.g., *Yersinia pestis*) may show considerable variation in size and shape called pleomorphism.

**3. Involution forms:** The involution forms are those that on ageing of culture show swollen and aberrant forms, especially in high salt concentration.

### ► Demonstration of cell wall

The cell walls can be demonstrated by (a) differential staining procedure, (b) electron microscopy, (c) plasmolysis, (d) microdissection, (e) mechanical rupture of the cell, and (f) serological test by exposure to specific antibodies.

## Cell Membrane

Cell membrane or plasma membrane is a thin (5–10 nm) semipermeable membrane that acts as an osmotic barrier. It lies beneath the cell wall separating it from the cell cytoplasm. Cell membrane primarily contains phospholipids and proteins. It also contains enzymes associated with DNA biosynthesis, cell wall polymers, and membrane lipids. Bacterial plasma membranes usually have a higher proportion of protein than eukaryotic membranes. They usually differ from eukaryotic membranes in lacking sterols, such as cholesterol, except in *Mycoplasma*. The cell membrane has following functions:

- It acts as a semipermeable membrane regulating the inflow and outflow of metabolites to and from the protoplasm.
- It helps in electron transport and oxidative phosphorylation.

## Cytoplasm

Bacterial cytoplasm is a colloidal suspension of a variety of organic and inorganic solutes in a viscous watery solution. The matrix is largely formed by nearly 70% water. Cytoplasm contains all the biosynthetic components required by a bacterium for growth and cell division, together with genetic material. Prokaryotic cytoplasm, unlike that of eukaryotes, lacks endoplasmic reticulum and mitochondria. It also does not show any protoplasmic streaming. Bacteria lack a true cytoskeleton. The cytoplasm consists of ribosomes, mesosomes, and intracytoplasmic inclusions bodies.

**Ribosomes:** The cytoplasmic matrix often is packed with ribosomes. Ribosomes look like small, featureless particles at low magnification in electron micrographs. They are smaller than their eukaryotic counterpart with sedimentation of 70S, compared with 80S in eukaryotes. They consist of two subunits of 30S and 50S, giving a net 70S. Ribosomes are important because:

- They serve as the sites of protein synthesis; matrix ribosomes synthesize proteins destined to remain within the cell, whereas plasma membrane ribosomes make proteins for transport to the outside.
- They are also the sites of actions of several antibiotics, such as amino glycosides, macrolides, and tetracyclines.

**Mesosomes:** These are vesicular convoluted or multilaminated structures formed as invagination of the plasma membrane into the cytoplasm. Mesosomes are of two types—septal and lateral. The septal mesosome attached to the bacterial DNA is believed to coordinate nuclear and cytoplasmic divisions during binary fission. The function of lateral mesosomes still remains to be known. Mesosomes are analogous to the mitochondria of eukaryotes and are the principal sites of respiratory enzymes in bacteria.

**Intracytoplasmic inclusion bodies:** Intracytoplasmic inclusion bodies are present in the protoplasm of bacteria. Their main function is believed to be of storage. This occurs when their main constituent element is present in excess in the culture medium. Since inclusion bodies are used for storage, their quantity can vary depending on the nutritional status of the cell. They are the sources of carbon, inorganic substances, and energy. Some inclusion bodies also function to reduce osmotic pressure.

They may be of two types: (i) organic inclusion bodies, which usually contain either glycogen or polyhydroxybutyrate, and (ii) inorganic inclusion bodies, which may be of polyphosphate granules or sulfur granules. Examples of intracytoplasmic inclusion bodies include metachromatic granules or volutin granules, starch inclusions, and lipid inclusions. Volutin granules, typically present in *C. diphtheriae*, can be demonstrated by Albert's stain. Similarly, starch granules present in the bacteria can be demonstrated on staining with iodine. Lipid inclusion found in Mycobacteria is demonstrated by Sudan black dye.

## Nucleus

The bacterial nucleus is neither enclosed in a nuclear membrane nor associated with any nucleolus. It is haploid and replicates by simple fission. The nucleus of the bacteria consists of a single circle of double-stranded deoxyribonucleic acid (DNA), arranged in a supercoiled circular structure. It measures about 1000  $\mu\text{m}$  when straightened.

The chromosome is located in an irregularly shaped region called nucleoid, but often referred to as bacterial chromosome because of the analogy with the eukaryotic structure. The nucleoid is visible through the light microscope after staining with the Feulgen stain, which specifically reacts with DNA.

In actively growing bacteria, the bacterial DNA can account for up to 20% of the volume of the bacterium and has projections that extend into the cytoplasmic matrix. Careful electron microscopic studies often have shown the nucleoid to be in contact with either the mesosome or the plasma membrane.

Many bacteria also possess smaller circles of extrachromosomal DNA called plasmids. The plasmids are double-stranded DNA molecules, usually circular, that can exist and replicate independently. Plasmids are not required for host growth and reproduction, although they may carry genes that confer the bacterium with properties such as antibiotics resistance or the capacity to produce toxins or enzymes.

## Capsule and Slime Layer

Many bacteria, both Gram-positive and Gram-negative, possess a gel-like layer outside the envelope when growing in their natural environments. When a gel-like layer forms a well-defined condensed layer around the bacterial envelope, it is called a **capsule** and is demonstrable by a light microscope. When this gel-like layer is narrower, detectable only by indirect serological methods or by electron microscope but not by light microscope, it is called a **microcapsule**. An amorphous viscid colloidal material secreted by some bacteria extracellularly is termed as loose or free **slime** or **glycocalyx**.

### ► Capsule

The capsule is mostly made up of polysaccharides, often referred to collectively as exopolysaccharides. Exopolysaccharides are sometimes neutral homopolysaccharides (e.g., the glucans and fructans of many oral streptococci) or negatively charged (Table 2-4).

However, *Bacillus anthracis* has a capsule comprising of polyamino acids, such as D-glutamic acid. The D-glutamic acid is probably analogous to the negatively charged polysaccharide capsule.

## Key Points

The capsule has various functions:

- It contributes to invasiveness of bacteria by protecting the bacteria from phagocytosis.
- It also prevents bacteria from generating immune response in infected hosts.
- It facilitates adherence of bacteria to surfaces. *Streptococcus mutans*, for example, owes its capacity to the glycocalyx to adhere tightly to tooth enamel to its glycocalyx.
- It plays a role in the formation of biofilms.
- The glycocalyx layer of the capsule may also play a role in resistance to desiccation.

## Demonstration of capsule

The capsule is fully hydrated and can be demonstrated by light microscopy in either living or stained bacteria as follows:

**Special capsular staining methods:** These include Welch method and M'Fadyean capsule stain. **Welch method** uses copper as mordant. This involves treatment of fixed smear with hot crystal violet solution followed by rinsing with copper sulfate solution. The latter is used to remove excess stain because conventional washing with water would dissolve the capsule. The copper salt also gives color to the background, with the result that the cell and background appear dark blue and the capsule of the bacteria a much paler blue. **M'Fadyean capsule stain**, using polychrome methylene blue stain, is a frequently used method for demonstration of capsule of *B. anthracis*.

**Negative staining with India ink:** Also known as wet India ink method. It is the simplest way to demonstrate capsule. It is carried out by mixing a suspension of bacteria with an equal volume of Indian ink on a slide, covering with a cover slip, and then examining it under microscope. The capsule appears as a clear zone around the cell. This method is useful for improving visualization of encapsulated bacteria in clinical samples, such as blood or cerebrospinal fluid.

**Serologic methods:** Since capsules are antigenic, they can be demonstrated by serologic methods. Quellung's reaction is

TABLE 2-4

Chemical composition of capsules of various bacteria

Organism	Polymer	Chemical subunits
<i>Bacillus anthracis</i>	Polypeptide	D-glutamic acid
<i>Enterobacter aerogenes</i>	Complex polysaccharide	Glucose, fucose, glucuronic acid
<i>Neisseria meningitidis</i>	Homopolymers and heteropolymers	Partially O-acetylated N-acetylmannosaminephosphate
<i>Streptococcus pneumoniae</i>	Complex polysaccharide (many types)	Rhamnose, glucose, glucuronic acid
<i>Streptococcus pyogenes</i> (group A)	Hyaluronic acid	N-acetylglucosamine, glucuronic acid
<i>Streptococcus salivarius</i>	Levan	Fructose

such a serological method for demonstration of capsule. When a suspension of bacterium is mixed with its specific anticapsular serum and methylene blue and examined under microscope, the capsule becomes very prominent and appears swollen due to increase in refractoriness. This method is useful for rapid identification of capsular serotypes of *S. pneumoniae*, *N. meningitidis*, *H. influenzae*, *Yersinia*, *Bacillus*, etc.

### ► Slime layer

Slime layer (S-layer) is a structured paracrystalline protein layer shown by electron microscopy. These are generally composed of a single kind of protein molecule, sometimes with carbohydrates attached. They are resistant to proteolytic enzymes and protein-denaturing agents. The slime layer protein protects the cell from wall-degrading enzymes and bacteriophages. It plays an important role in the maintenance of cell shape, and it may be involved in cell adhesion to host epidermal surfaces.

## Surface Appendages

The surface appendages of the bacteria include flagella and fimbriae or pili.

### ► Flagella

Bacterial flagella are thread-like appendages intricately embedded in the cell envelope. These structures are responsible for conferring motility to the bacteria. The arrangement of flagella varies between different bacterial species. Depending on the arrangement, flagella can be of the following types:

- Monotrichous (single polar flagellum), e.g., *Vibrio cholerae*.
- Lophotrichous (multiple polar flagella), e.g., *Spirilla*.
- Peritrichous (flagella distributed over the entire cell), e.g., *Salmonella Typhi*, *E. coli*, etc.
- Amphitrichous (single flagellum at both the ends), e.g., *Spirillum minus* (Fig. 2-11).

**Structure:** The flagella are 3–20  $\mu\text{m}$  in length and 0.01–0.03  $\mu\text{m}$  in diameter. The main part of the filament is made up of protein subunits called flagellin arranged in several helices around a central hollow core. The flagellum is attached to the bacterial cell

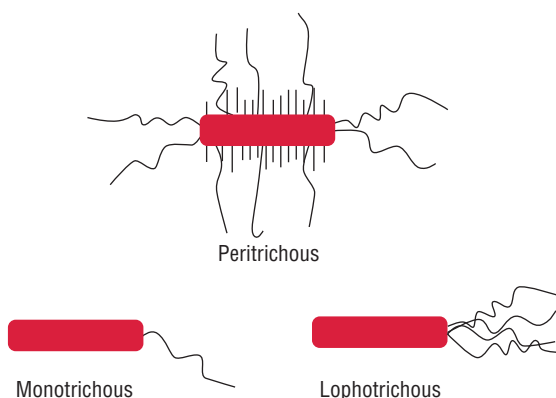

FIG. 2-11. Arrangement of the bacterial flagella.

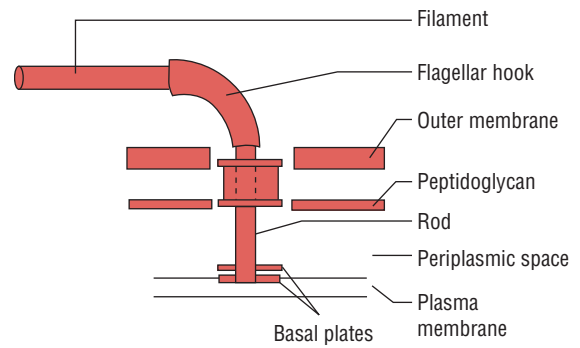

FIG. 2-12. Structure of a bacterial flagellum.

body by a complex structure consisting of a hook and a basal body. The basal body bears a set of rings, one pair in Gram-positive bacteria and two pairs in Gram-negative bacteria, through which the bacteria rotates either in a clockwise or an anticlockwise direction. Above the base of filament is the hook, a short curved structure between the external filament and basal body. This part produces a propeller-like repulsion from the revolving flagellum (Fig. 2-12).

Spirochetes are motile bacteria but without any external flagella. They are motile due to the presence of an axial filament. Axial filament consists of a bundle of flagellum-like structures that lie between the cell surface and an outer sheath, and connects one end of the cell to the other. They are sometimes called the endoflagellates.

**Function:** Flagella have the following functions:

- They are primarily responsible for motility of bacteria by chemotaxis.
- They may play a role in bacterial survival and pathogenesis. They are highly antigenic, they possess H antigens, and some of the immune responses to infection are directed against these proteins. The flagella of different bacteria differ antigenically. Flagellar antibodies are not protective but help in serodiagnosis.

**Demonstration of flagella:** The flagella can be demonstrated by direct and indirect methods. The direct methods include direct demonstration of capsule by electron microscope. These also include demonstration of capsule after staining by special staining methods, such as Ryu's method and Hugh-Leifson's method. Since flagella are very thin structures, these staining methods are used to demonstrate flagella by increasing their thickness by mordanting with tannic acid.

Indirect methods of demonstration of flagella include demonstration of motility of the bacteria by (a) dark-ground microscopy, (b) hanging drop method, or (c) observing spreading type growth on semisolid media, such as mannitol motility medium.

### ► Pili (fimbriae)

Pili or fimbriae are synonymous for most purposes. They are hair-like filaments that extend from cell surface and are found almost exclusively on Gram-negative bacteria. They are

composed of structural protein subunits termed pilins. Minor proteins termed adhesins are located at the tips of pili and are responsible for the attachment properties.

**Structure:** The pili are shorter and straighter than flagella, although the basic structure is same. Like flagella, it consists of helics of protein called *pilins*, arranged around a hollow core but without a motor. They are 0.5  $\mu\text{m}$  long and 10 nm thick. They are antigenic in nature. Pili hemagglutinate RBCs of guinea pigs and are specifically inhibited by mannose, on the basis of which they are classified into four types as follows:

- **Type 1:** These occur in *E. coli*, *Klebsiella*, *Shigella*, and *Salmonella*. They are mannose sensitive.
- **Type 2:** These are present in *Salmonella Gallinarum* and *Salmonella Pullorum*, devoid of any hemagglutinating or adhesive properties.
- **Type 3:** These are present in some strains of *Klebsiella*, *Serratia*, etc. They agglutinate RBC only after heating and are mannose resistant.
- **Type 4:** These are mannose resistant and occur in *Proteus*.

**Sex pili:** A specialized kind of pili called sex pili is responsible for the attachment of donor and recipient cells in bacterial conjugation. These pili are longer (10–20  $\mu\text{m}$ ) and vary 1–4 in number. The sex pili are of two types:

- (i) **F pili:** They specifically adsorb male specific RNA and DNA bacteriophages. They are encoded by sex factor F and fertility inhibition–positive resistance factors ( $f_i + R$  factors).
- (ii) **I pili:** They adsorb male specific filamentous DNA phages, encoded by col factor and  $f_i - R$  factor.

**Function:** Pili play a major role in the adherence of symbiotic and pathogenic bacteria to host cells, which is a necessary step in initiation of infection. Transfer of bacterial DNA takes place through sex pili during the process of conjugation.

**Demonstration of pili:** The pili can be detected:

- Directly by electron microscope and
- By agglutination of RBCs of guinea pigs, fowl, horses, and pigs. They agglutinate human and sheep RBCs weakly. The hemagglutination can be specifically inhibited by D-mannose.

Some of the Gram-positive bacteria do not possess typical pili but instead possess a fine fibrillar arrangement of proteins on their surfaces known as fibrils. These fibrils bind to the host surfaces. M-protein of *S. pyogenes* is an example of Gram-positive bacteria possessing fibrils.

## Sporulation

Sporulation is a primitive process of differentiation with formation of endospores, a highly resistant resting phase of some of the bacteria (e.g., spores of aerobic *Bacillus* spp. and anaerobic *Clostridium* spp.). The organism survives in spores, a dormant state, for longer period of starvation and other adverse conditions.

**Sporulation process** begins in nutrition deprived conditions. It begins with the formation of an axial filament. The process continues with infolding of the membrane so as to produce a

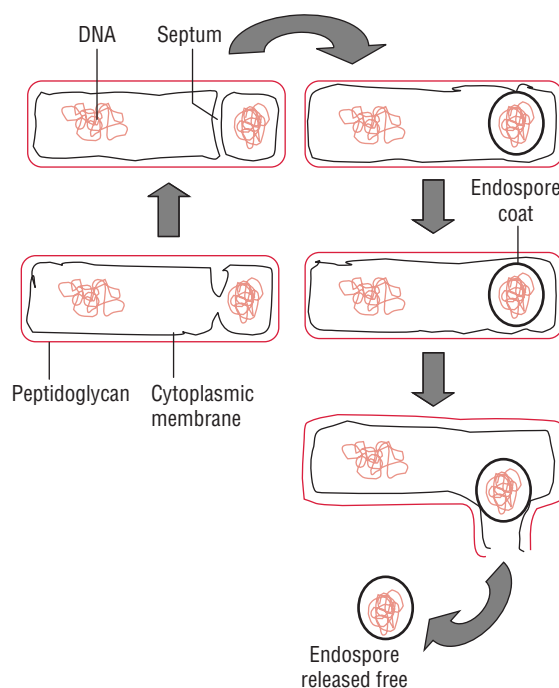

**FIG. 2-13.** Schematic diagram showing process of bacterial sporulation.

double membrane structure whose facing surfaces correspond to the cell wall-synthesizing surface of the cell envelope. The growing points move progressively toward the pole of the cell so as to engulf the developing spore. Two spore membranes then engage in the active synthesis of special layers that form the cell envelope: the spore wall and the cortex, lying outside the facing membranes. In the newly isolated cytoplasm, or core, many vegetative cell enzymes are degraded and are replaced by a set of unique spore constituents. During the process of sporulation, each cell forms a single internal spore; the spore germinates to produce a single vegetative cell (Fig. 2-13).

## Spores

**Morphology:** The endospores are a highly resistant resting phase of bacteria. The spore shows following structures.

1. **Core:** The core contains a complete nucleus (chromosome), all of the components of the protein-synthesizing apparatus, and an energy-generating system based on glycolysis. The heat resistance of spores is due in part to their dehydrated state and in part to the presence of large amounts (5–15% of the spore dry weight) of calcium dipicolinate in the core.
2. **Spore wall:** This is the innermost layer surrounding the inner spore membrane. It contains normal peptidoglycan and becomes the cell wall of the germinating vegetative cell.
3. **Cortex:** It is the thickest layer of the spore envelope containing unusual peptidoglycan. It is extremely sensitive to lysozyme, and its autolysis plays a role in spore germination.
4. **Protein coat:** It is composed of a keratin-like protein containing many intramolecular disulfide bonds; this layer confers relative resistance to antibacterial chemical agents due to its impermeability (Fig. 2-14).

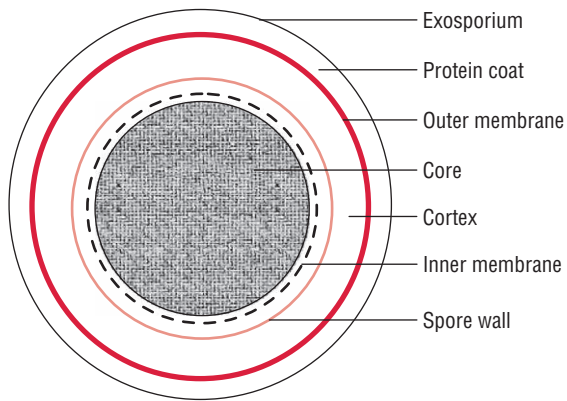

FIG. 2-14. Diagrammatic representation of bacterial spore.

The spores may vary among different species depending on the position, shape, and relative size of the spores. For example, spores may be central, subterminal or terminal; may be oval or spherical in shape; and may be bulging or nonbulging.

**Demonstration of spores:** Spores are most simply observed as intracellular refractile bodies in unstained cell suspensions or as colorless areas in cells stained by conventional methods, such as Gram staining. Spores are commonly stained with malachite green or carbol fuchsin. On staining by modified ZN stain (using 0.25–0.5% sulfuric acid instead of 20% sulfuric acid), the spores appear as red acid-fast bodies.

**Properties of spores:** Bacterial spores are resistant to ordinary boiling, disinfectants, and heating. Spores of all medically important bacteria are destroyed by autoclaving at 121°C for 15 minutes. The process of conversion of a spore into vegetative cell under suitable conditions is known as germination. The germination process occurs in three stages: activation, initiation, and outgrowth.

## Key Points

The spores have certain uses in clinical microbiology:

- The spores of *Bacillus stearothermophilus* are used as indicator of proper sterilization by autoclaving. These spores are destroyed at a temperature of 121°C for 10–20 minutes, the time required for autoclaving.
- The spores of certain bacteria, such as *B. anthracis* are misused as agents of bioterrorism.

## Growth and Multiplication of Bacteria

Bacterial growth can be defined as an orderly increase of all the chemical components of the cell. Cell multiplication is a consequence of growth that leads to an increase in the number of bacteria making up a population or culture. Most bacteria divide by binary fission in which the bacteria undergo cell division to produce two daughter cells identical to the parent cell. Bacterial growth can be equated to cell number: one bacterium divides into two, these two produce four, and then eight, and so on

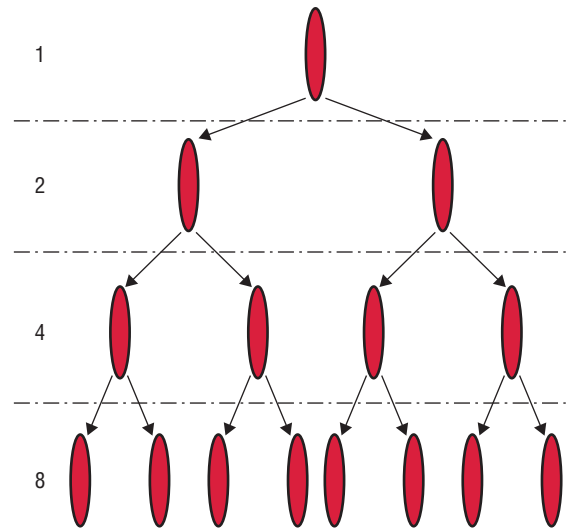

FIG. 2-15. Schematic diagram showing binary fission of the bacteria.

(Fig. 2-15). The growth rate of a bacterium is therefore measured by measuring the change in bacterial number per unit time.

## Generation Time

Generation time is the time required for a bacterium to give rise to two daughter cells under optimum conditions. The generation time for most of the pathogenic bacteria, such as *E. coli*, is about 20 minutes. The generation time is longer (i.e., 20 hours) for *M. tuberculosis* and longest (i.e., 20 days) for *M. leprae*. A bacterium replicates and multiplies rapidly producing millions of cells within 24 hours. For example, *E. coli* in about 7 hours can undergo 20 generations and produce 1 million cells, in about 10 hours undergo 30 generations and produce 1 billion cells, and in 24 hours produces  $10^{21}$  cells (Fig. 2-16). However, in actual practice, the multiplication of bacteria is arrested after a few cell divisions due to exhaustion of nutrients and accumulation of toxic products.

## Bacterial Count

Microbial concentrations can be measured in terms of (i) cell concentration (the number of viable cells per unit volume of culture) or (ii) biomass concentration (dry weight of cells per unit volume of culture). The number of bacteria at a given time can be estimated by performing a total count or viable count.

**Total count:** This denotes the total number of bacteria in the sample, irrespective of whether they are living or dead. This is done by counting the bacteria under the microscope using counting chamber or by comparing the growth with standard opacity tubes.

**Viable count:** This usually indicates the number of living or viable bacteria. This count can be obtained by dilution or plating method.

- In **dilution method**, several tubes with liquid culture media are incubated with varying dilutions of sample and the viable count is calculated from the number of tubes showing bacterial growth. This method is widely used in

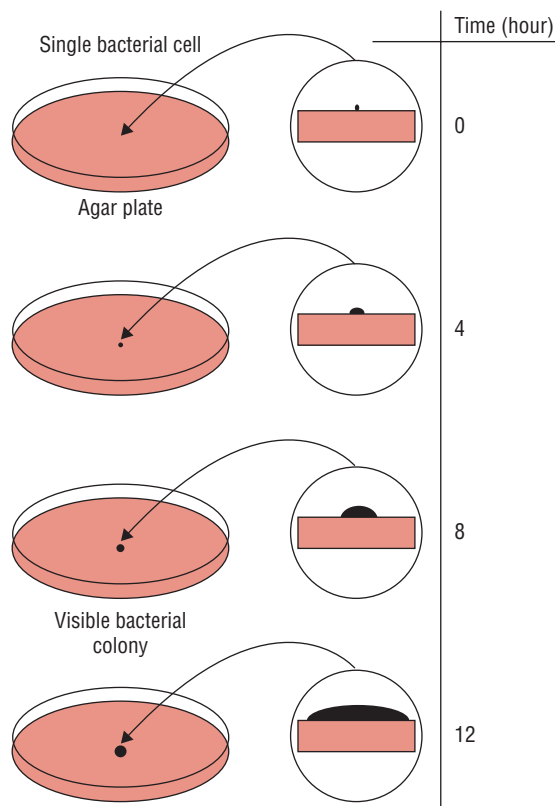

FIG. 2-16. Generation time of the bacteria.

microbiological testing of water for presumptive coliform count in drinking water.

- In the **plate method**, a sample is diluted and small volume of it is spread on the surface of an agar plate. The number of colonies that grow after a suitable incubation time indicates viable count of the bacteria.

## Bacterial Growth Curve

When a broth culture is inoculated with a small bacterial inoculum, the population size of the bacteria increases showing a classical pattern. The bacterial growth curve shows the following four distinct phases (Fig. 2-17):

**1. Lag phase:** After a liquid culture broth is inoculated, the multiplication of bacteria does not start immediately. It takes some time to multiply. The time between inoculation and beginning of multiplication is known as lag phase. In this phase, the inoculated bacteria become acclimatized to the environment, switch on various enzymes, and adjust to the environmental temperature and atmospheric conditions. During this phase, there is an increase in size of bacteria but no appreciable increase in number of bacterial cells. The cells are active metabolically. The duration of the lag phase varies with the bacterial species, nature of culture medium, incubation temperature, etc. It may vary from 1 hour to several days.

**2. Log phase:** This phase is characterized by rapid exponential cell growth (i.e., 1 to 2 to 4 to 8 and so on). The bacterial

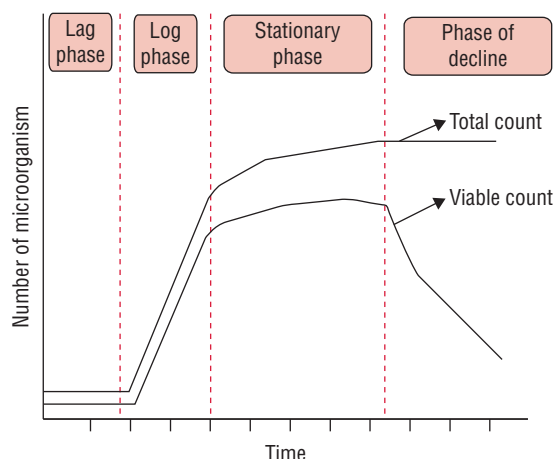

FIG. 2-17. Bacterial growth curve.

TABLE 2-5

Growth rate during different phases of bacterial growth curve

Phase	Growth rate
Lag	Zero
Log or exponential	Constant
Stationary	Zero
Decline	Negative (death)

population doubles during every generation. They multiply at their maximum rate. The bacterial cells are small and uniformly stained. The microbes are sensitive to adverse conditions, such as antibiotics and other antimicrobial agents.

**3. Stationary phase:** After log phase, the bacterial growth almost stops completely due to lack of essential nutrients, lack of water oxygen, change in pH of the medium, etc. and accumulation of their own toxic metabolic wastes. Death rate of bacteria exceeds the rate of replication of bacteria. Endospores start forming during this stage. Bacteria become Gram variable and show irregular staining. Many bacteria start producing exotoxins.

**4. Decline phase:** During this phase, the bacterial population declines due to death of cells. The decline phase starts due to (a) accumulation of toxic products and autolytic enzymes and (b) exhaustion of nutrients. Involution forms are common in this stage. Growth rate during different phases of bacterial growth curve is summarized in Table 2-5.

The **continuous culture** is a method of culture useful for industrial and research purpose. This is achieved by using a special device for replenishing nutrients and removing bacterial population continuously so that bacteria growth is not inhibited due to lack of nutrients or due to accumulation of toxic bacterial metabolites.

## Factors Affecting Growth of Bacteria

A variety of factors affect growth of bacteria. These are discussed below:

## ► Oxygen

Bacteria on the basis of their oxygen requirements can be classified broadly into aerobic and anaerobic bacteria.

**Aerobic bacteria:** They require oxygen for their growth. They may be:

- Obligate aerobes—which can grow only in the presence of oxygen (e.g., *P. aeruginosa*).
- Facultative aerobes—which are ordinary aerobes but can also grow without oxygen (e.g., *E. coli*). Most of the pathogenic bacteria are facultative aerobes.
- Microaerophilic bacteria—those bacteria that can grow in the presence of low oxygen and in the presence of low (4%) concentration of carbon dioxide (e.g., *Campylobacter jejuni*).

Some fermentative organisms (e.g., *Lactobacillus plantarum*) are aerotolerant but do not contain the enzyme catalase or superoxide dismutase. Oxygen is not reduced, and therefore hydrogen peroxide ( $H_2O_2$ ) and nascent oxygen ( $O_2^-$ ) are not produced.

**Anaerobic bacteria:** Obligate anaerobes are the bacteria that can grow only in the absence of oxygen (e.g., *Clostridium botulinum*, *Clostridium tetani*, etc.). These bacteria lack superoxide dismutase and catalase; hence oxygen is lethal to these organisms.

## ► Carbon dioxide

The organisms that require higher amounts of carbon dioxide ( $CO_2$ ) for their growth are called capnophilic bacteria. They grow well in the presence of 5–10%  $CO_2$  and 15%  $O_2$ . In candle jar, 3%  $CO_2$  can be achieved. Examples of such bacteria include *H. influenzae*, *Brucella abortus*, etc.

## ► Temperature

The optimum temperature for most of the pathogenic bacteria is 37°C. The optimal temperature, however, is variable; depending on their temperature range, growth of bacteria is grouped as follows:

- **Psychrophiles:** These bacteria are cold loving microbes that grow within a temperature range of 0–20°C. Most of soil and water saprophytes belong to this group.
- **Mesophiles:** These are moderate temperature loving microbes that grow between 25°C and 40°C. Most of pathogenic bacteria belong to this group.
- **Thermophiles:** These are heat loving microbes. They can grow at a high temperature range of 55–80°C. *B. stearothermophilus* is an example.

## ► pH

Most pathogenic bacteria grow between pH 7.2 and 7.6. Very few bacteria, such as lactobacilli, can grow at acidic pH below 4.0. Many food items, such as pickles and cheese, are prevented from spoilage by acids produced during fermentation. *V. cholerae* is an example of the bacteria that can grow at an alkaline (8.2–8.9) pH.

## ► Light

Depending on the source of energy bacteria make use of, they may be classified as phototrophs (bacteria deriving energy from sunlight) or chemotrophs (bacteria deriving energy from chemical sources).

## ► Osmotic pressure

Microbes obtain almost all their nutrients in solution from surrounding water. Hence factors such as osmotic pressure and salt concentration of the solution affect the growth of bacteria. Bacteria by virtue of mechanical strength of their cell wall are able to withstand a wide range of external osmotic variations. Organisms requiring high osmotic pressures are called osmophilic bacteria. Sudden exposure of bacteria to hypertonic solution may cause osmotic withdrawal of water, leading to osmotic shrinkage of the protoplasm (*plasmolysis*). On the other hand, sudden transfer of bacteria from concentrated solution to distilled water may cause excessive imbibition of water leading to swelling and bursting of cell (*plasmoptysis*).

## Bacterial Nutrition

The minimum requirements for growth of bacteria include water, a source of carbon, a source of nitrogen, and certain inorganic salts. These are required for synthesis of proteins, enzymes, etc. For example,

- Nitrogen is required for synthesis of proteins, DNA, RNA, and ATP.
- Sulfur is required for certain amino acids and vitamins, and phosphorus is required for nucleic acids, ATP, and phospholipids.
- In addition, inorganic ions, such as potassium, sodium, iron, magnesium, calcium, and chloride are required to facilitate enzymatic catalysis and to maintain chemical gradients across the cell membrane.

Some bacteria grow in a variety of simple media. *E. coli* and other members of the family Enterobacteriaceae are examples of bacteria that can grow in a variety of simple media containing the inorganic salts and with a source of energy, the simplest being glucose. The inorganic salts in the media provide major essential elements of carbon, hydrogen, oxygen, nitrogen, phosphate, and sulfur. These chemicals are usually present in the media and are not added specifically.

Some bacteria, such as *H. influenzae* and other related bacteria, on other hand, are very fastidious and have certain growth requirements. They require certain amino acids, vitamins, and other growth factors that are supplied by adding yeast extract and meat digests to the media. They also require addition of blood or serum for their growth.

Certain lower forms of bacteria even fail to grow in cell-free culture media and require living cells for their growth.

*T. pallidum* and *M. leprae* are two pathogenic bacteria that cannot grow in any artificial culture media, but can only be cultured when inoculated into living animals.

# Sterilization and Disinfection

## Introduction

Microbes are ubiquitous and many microorganisms are associated with undesirable consequences, such as food spoilage and disease. Therefore, it is essential to kill a wide variety of microorganisms or inhibit their growth to minimize their destructive effects. The goal is twofold: (a) to destroy pathogens and prevent their transmission and (b) to reduce or eliminate microorganisms responsible for the contamination of water, food, and other substances.

## Definition of Frequently Used Terms

**Sterilization** is defined as a process by which an article, surface, or medium is freed of all living microorganisms either in the vegetative or in the spore state. Any material that has been subjected to this process is said to be **sterile**. These terms should be used only in the absolute sense. An object cannot be slightly sterile or almost sterile; it is either sterile or not sterile. Although most sterilization is performed with a physical agent, such as heat, a few chemicals called **sterilants** can be classified as sterilizing agents because of their ability to destroy spores.

A **germicide**, also called a **microbicide**, is any chemical agent that kills pathogenic microorganisms. A germicide can be used on inanimate (nonliving) materials or on living tissue, but it ordinarily cannot kill resistant microbial cells. Any physical or chemical agent that kills “germs” is said to have **germicidal** properties.

**Disinfection** refers to the use of a chemical agent that destroys or removes all pathogenic organisms or organisms capable of giving rise to infection. This process destroys vegetative pathogens but not bacterial endospores. It is important to note that disinfectants are normally used only on inanimate objects because they can be toxic to human and other animal tissue, when used in higher concentrations. Disinfection processes also remove the harmful products of microorganisms (toxins) from materials. Examples of disinfection include (a) applying a solution of 5% bleach to examining table, (b) boiling food utensils used by a sick person, and (c) immersing thermometers in an isopropyl alcohol solution between use.

In modern usage, **sepsis** is defined as the growth of microorganisms in the body or the presence of microbial toxins in blood and other tissues. The term **asepsis** refers to any practice that prevents the entry of infectious agents into sterile tissues and thus prevents infection.

Chemical agents called **antiseptics** are applied directly to the exposed body surfaces (e.g., skin and mucous membranes), wounds, and surgical incisions to destroy or inhibit vegetative pathogens. Examples of antiseptics include (a) preparing the skin before surgical incisions with iodine compounds, (b) swabbing an open root canal with hydrogen peroxide, and (c) ordinary hand washing with a germicidal soap.

**Sanitization** is any cleansing technique that mechanically removes microorganisms (along with food debris) to reduce the level of contaminants. A **sanitizer** is a compound (e.g., soap or detergent) that is used to perform this task. Cooking utensils, dishes, bottles, cans, and used clothing that have been washed and dried may not be completely free of microbes, but they are considered safe for normal use. Air sanitization with ultraviolet lamps reduces airborne microbes in hospital rooms, veterinary clinics, and laboratory installations.

It is often necessary to reduce the numbers of microbes on the human skin through **degerming procedures**. This process usually involves scrubbing the skin or immersing it in chemicals, or both. It also emulsifies oils that lie on the outer cutaneous layer and mechanically removes potential pathogens from the outer layers of the skin. Examples of degerming procedures are (a) surgical hand scrub, (b) application of alcohol wipes to the skin, and (c) cleansing of a wound with germicidal soap and water. The concepts of antiseptics and degerming procedures clearly overlap, since a degerming procedure can be simultaneously treated as an antiseptic and vice versa.

## Sterilization

Methods of sterilization can be broadly classified as:

1. Physical methods of sterilization, and
2. Chemical methods of sterilization.

## Physical Methods of Sterilization

Physical methods of sterilization include the following:

1. Sunlight
2. Heat
3. Filtration
4. Radiation
5. Sound (sonic) waves

### ► Sunlight

Direct sunlight is a natural method of sterilization of water in tanks, rivers, and lakes. Direct sunlight has an active germicidal



effect due to its content of ultraviolet and heat rays. Bacteria present in natural water sources are rapidly destroyed by exposure to sunlight.

## ► Heat

Heat is the most dependable method of sterilization and is usually the method of choice unless contraindicated. As a rule, higher temperatures (exceeding the maximum) are *microbicidal*, whereas lower temperatures (below the minimum) tend to have inhibitory or *microbistatic* effects. Two types of physical heat are used in sterilization—moist and dry heat.

### Sterilization by moist heat

Moist heat occurs in the form of hot water, boiling water, or steam (vaporized water). In practice, the temperature of moist heat usually ranges from 60 to 135°C. Adjustment of pressure in a closed container can regulate the temperature of steam. Moist heat kills microorganisms by denaturation and coagulation of proteins. Sterilization by moist heat can be classified as follows:

1. Sterilization at a temperature <100°C
  2. Sterilization at a temperature of 100°C
  3. Sterilization at a temperature >100°C
  4. Intermittent sterilization
1. **Sterilization at a temperature <100°C:** Pasteurization is an example of sterilisation at a temperature <100°C.

**Pasteurization:** Fresh beverages (such as milk, fruit juices, beer, and wine) are easily contaminated during collection and processing. Because microbes have potential for spoiling these foods or causing illness, heat is frequently used to reduce the microbial load and to destroy pathogens. Pasteurization is a technique in which heat is applied to liquids to kill potential agents of infection and spoilage, while at the same time retaining the liquid's flavor and food value. This technique is named after Louis Pasteur who devised this method. This method is extensively used for sterilization of milk and other fresh beverages, such as fruit juices, beer, and wine which are easily contaminated during collection and processing.

## Key Points

Two methods of pasteurization are followed: flash method and holder method.

- In the flash method, milk is exposed to heat at 72°C for 15–20 seconds followed by a sudden cooling to 13°C or lower.
- In the holder method, milk is exposed to a temperature of 63°C for 30 minutes followed by cooling to 13°C or lower, but not less than 6°C.

The flash method is preferable for sterilization of milk because it is less likely to change the flavor and nutrient content, and it is more effective against certain resistant pathogens, such as *Coxiella* and *Mycobacterium*.

Although pasteurization inactivates most viruses and destroys the vegetative stages of 97–99% of bacteria and

fungi, it does not kill endospores or *thermoduric* species (mostly nonpathogenic lactobacilli, micrococci, and yeasts). Milk is not sterile after regular pasteurization. In fact, it can contain 20,000 microbes per milliliter or more, which explains why even an unopened carton of milk will eventually spoil on prolonged storage. Newer techniques have now been used to produce *sterile milk* that has a storage life of 3 months. In this method, milk is processed with *ultrahigh temperature* (UHT) of 134°C for 1–2 seconds.

2. **Sterilization at a temperature of 100°C:** Sterilisation at a temperature of 100°C includes (a) boiling and (b) steam sterilizer at 100°C.

**Boiling:** Simple boiling of water for 10–30 minutes kills most of the vegetative forms of bacteria but not bacterial spores. Exposing materials to boiling water for 30 minutes kills most nonspore-forming pathogens including resistant species, such as the tubercle bacillus and staphylococci. Sterilization by boiling is facilitated by addition of 2% sodium bicarbonate to water. Since boiling only once at 100°C does not kill all spores, this method cannot be used for sterilization but only for disinfection. Hence, it is not recommended for sterilizing instruments used for surgical procedure. The greatest disadvantage of this method is that the items sterilized by boiling can be easily recontaminated when removed from water after boiling.

**Steam sterilizer at 100°C:** Usually, Koch's or Arnold's steam sterilizer is used for heat-labile substances that tend to degrade at higher temperatures and pressure, such as during the process of autoclaving. These substances are exposed to steam at atmospheric pressure for 90 minutes during which most vegetative forms of the bacteria except for the thermophiles are killed by the moist heat.

3. **Sterilization at a temperature >100°C:** This method is otherwise known as sterilization by steam under pressure. A temperature of 100°C is the highest that steam can reach under normal atmospheric pressure at sea level. This pressure is measured at 15 pounds per square inch (*psi*), or 1 atmosphere. In order to raise the temperature of steam above this point, it must be pressurized in a closed chamber. This phenomenon is explained by the physical principle that governs the behavior of gases under pressure. When a gas is compressed, its temperature rises in direct relation to the amount of pressure. So, when the pressure is increased to 5 psi above normal atmospheric pressure, the temperature of steam rises to 109°C. When the pressure is increased to 10 psi above normal, its temperature will be 115°C and at 15 psi (a total of 2 atmospheres), it will be 121°C. It is not the pressure by itself that is killing microbes, but the increased temperature it produces. This forms the principle of sterilization by steam under pressure. Such pressure–temperature combinations can be achieved only with a special device that can subject pure steam to pressures greater than 1 atmosphere. Health and commercial industries use an *autoclave* for this purpose and a comparable home appliance is the *pressure cooker*.

**Autoclave:** It is a cylindrical metal chamber with an airtight door at one end and racks to hold materials. The lid is fastened by screw clamp and rendered airtight by an asbestos washer. It has a discharge tap for air and steam at the upper side, a pressure gauge and a safety valve that can be set to blow off at any desired pressure. Heating is usually carried out by electricity. Steam circulates within the jacket and is supplied under pressure to the inner chamber where materials are loaded for sterilization (Fig. 3-1). The water in the autoclave boils when its vapor pressure equals that of surrounding atmosphere. Following the increase of pressure inside the closed vessel, the temperature at which the water boils inside the autoclave also increases. The saturated steam that has a higher penetrative power, on coming in contact with a cooler surface condenses to water and releases its latent heat to that surface. For example, nearly 1600 mL steam at 100°C and at atmospheric pressure condenses into 1 mL of water at 100°C and releases 518 calories of heat. The gross reduction in volume of steam sucks in more steam to the area and this process continues till the temperature of that surface is elevated to that of the steam. Sterilization is achieved when the steam condenses against the objects in the chamber and gradually raises their temperature. The condensed water facilitates moist conditions that ensures killing of microbes.

**Sterilization condition:** Experience has shown that the most efficient pressure-temperature combination for achieving sterilization by autoclave is 15 psi, which yields 121°C. It is possible to use higher pressure to reach higher temperatures (for instance, increasing the pressure to 30 psi raises the temperature by 11°C), but doing so will not significantly reduce the exposure time and can harm the items being sterilized. It is important to avoid over packing or haphazardly loading the chamber, because it prevents

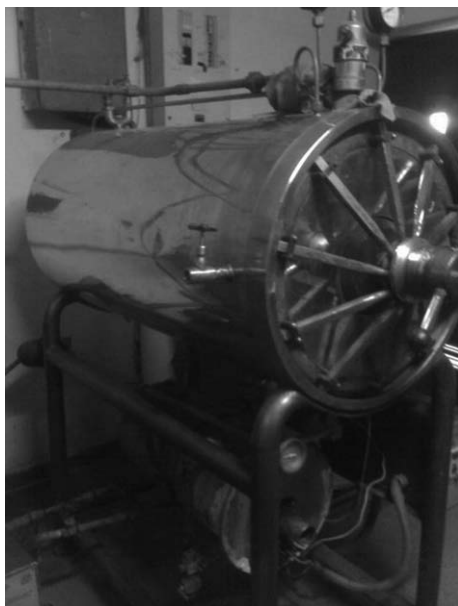

FIG. 3-1. Autoclave.

steam from circulating freely around the contents and impedes the full contact that is necessary. The holding time varies from 10 minutes for light loads to 40 minutes for heavy or bulky ones; the average time being 20 minutes.

## Key Points

**Uses of autoclave:** The autoclave has many uses, which are given below:

- It is a good method to sterilize heat-resistant materials, such as glassware, cloth (surgical dressings), rubber (gloves), metallic instruments, liquids, paper, some media, and some heat-resistant plastics.
- It is also useful for sterilization of heat-sensitive items, such as plastic Petri plates that need to be discarded.
- It is useful for sterilization of materials that cannot withstand the higher temperature of the hot-air oven.

However, the autoclave is ineffective for sterilizing substances that repel moisture (oils, waxes, or powders). Types and uses of various moist heat sterilization methods are summarized in Table 3-1.

**Sterilization controls:** Various sterilization controls are used to determine the efficacy of sterilization by moist heat. These include (a) thermocouples, (b) chemical indicators, and (c) bacteriological spores as mentioned below:

- (a) Thermocouples are used to record temperatures directly in autoclaves by a potentiometer.
- (b) Brown's tube is the most commonly used chemical indicator of moist heat sterilization in the autoclave. It contains red solution that turns green when exposed to temperature of 121°C for 15 minutes in an autoclave.
- (c) *Bacillus stearothermophilus* spores are used as the indicators of moist heat sterilization in the autoclave. This is a thermophilic bacterium with an optimum temperature of 55–60°C, and its spores require an exposure of 12 minutes at 121°C to be destroyed. The efficacy of the autoclave is carried out by placing paper strips impregnated with  $10^6$  spores in envelopes and keeping those envelopes in different parts of the load inside the autoclave. These strips after sterilization are inoculated into a suitable recovery medium and

TABLE 3-1

### Types and uses of moist heat sterilization

Method	Uses	Comments
Water bath below 100°C	For sterilization of serum, body fluids, and vaccines	Only disinfection possible. Spores would be spared
Water bath at 100°C	For sterilization of glass, metal, and rubber items	Some spores will still be spared at this temperature
Arnold steamer: steaming at 100°C	For sterilization of culture media containing sugar and gelatin	Preserves properties of media
Autoclave: steam under pressure	For sterilization of culture media and operation theater as well as laboratory materials	Kills all the vegetative as well as spore forms of bacteria

incubated at 55°C for 5 days. Spores are destroyed if the sterilizing condition of the autoclave is proper.

4. **Intermittent sterilization:** Certain heat-labile substances (e.g., serum, sugar, egg, etc.) that cannot withstand the high temperature of the autoclave can be sterilized by a process of intermittent sterilization, known as tyndallization.

**Tyndallization** is carried out over a period of 3 days and requires a chamber to hold the materials and a reservoir for boiling water. Items to be sterilized are kept in the chamber and are exposed to free-flowing steam at 100°C for 20 minutes, for each of the three consecutive days. On the first day, the temperature is adequate to kill all the vegetative forms of the bacteria, yeasts, and molds but not sufficient to kill spores. The surviving spores are allowed to germinate to vegetative forms on the second day and are killed on re-exposure to steam. The third day re-ensures killing of all the spores by their germination to vegetative forms.

Intermittent sterilization is used most often to sterilize heat-sensitive culture media, such as those containing sera (e.g., Loeffler's serum slope), egg (e.g., Lowenstein-Jensen's medium), or carbohydrates (e.g., serum sugars) and some canned foods.

### Sterilization by dry heat

Sterilization by dry heat makes use of air with a low moisture content that has been heated by a flame or electric heating coil. In practice, the temperature of dry heat ranges from 160°C to several thousand degrees Celsius. The dry heat kills microorganisms by protein denaturation, oxidative damage, and the toxic effect of increased level of electrolytes. Dry heat is not as versatile or as widely used as moist heat, but it has several important sterilization applications. The temperature and time employed in dry heat vary according to the particular method, but in general they are greater than with moist heat. Sterilization by dry heat includes sterilization by (a) flaming, (b) incineration, and (c) hot air oven:

1. **Flaming:** Sterilization of inoculating loop or wire, the tip of forceps, searing spatulas, etc., is carried out by holding them in the flame of the Bunsen burner till they become red hot. Glass slides, scalpels, and mouths of culture tubes are sterilized by passing them through the Bunsen flame without allowing them to become red hot.
2. **Incineration:** Incineration is an excellent method for safely destroying infective materials by burning them to ashes. It has many uses:
  - Incinerators are used to carry out this process and are regularly employed in hospitals and research labs to destroy hospital and laboratory wastes.
  - The method is used for complete destruction and disposal of infectious material, such as syringes, needles, culture material, dressings, bandages, bedding, animal carcasses, and pathology samples.
  - This method is fast and effective for most hospital wastes, but not for metals and heat-resistant glass materials.



FIG. 3-2. Hot-air oven.

3. **Hot-air oven:** The hot-air oven provides another means of dry heat sterilization and is the most widely used method. The hot-air oven is electrically heated and is fitted with a fan to ensure adequate and even distribution of hot air in the chamber. It is also fitted with a thermostat that ensures circulation of hot air of desired temperature in the chamber. Heated, circulated air transfers its heat to the materials inside the chamber. While sterilizing by hot-air oven, it should be ensured that the oven is not overloaded. The materials should be dry and arranged in a manner which allows free circulation of air inside the chamber. It is essential to fit the test tubes, flasks, etc., with cotton plugs and to wrap Petri dishes and pipettes in a paper. Sterilization by hot-air oven requires exposure to 160–180°C for 2 hours and 30 minutes, which ensures thorough heating of the objects and destruction of spores (Fig. 3-2).

### Key Points

**Hot-air oven** is used in laboratories and clinics for heat-resistant items that are not sterilized well by moist heat. They are used for sterilization of:

- Glasswares (syringes, Petri dishes, flasks, pipettes, test tubes, etc.).
- Surgical instruments (scalpels, scissors, forceps, etc.).
- Chemicals (liquid paraffin, sulfonamide powders, etc.); and
- Oils that are not penetrated well by steam used in moist heat sterilization.

Thermocouples, chemical indicators, and bacteriological spores of *Bacillus subtilis* are used as sterilization controls to determine the efficacy of sterilization by hot-air oven.

### ► Filtration

Filtration is an excellent way to reduce the microbial population in solutions of heat-labile material by use of a variety of filters. Filters are used to sterilize these heat-labile solutions.

Filters simply remove contaminating microorganisms from solutions rather than directly destroying them. The filters are of two types: (a) depth filters and (b) membrane filters.

**1. Depth filters:** Depth filters consist of fibrous or granular materials that have been bonded into a thick layer filled with twisting channels of small diameter. The solution containing microorganisms is sucked in through this layer under vacuum and microbial cells are removed by physical screening or entrapment and also by adsorption to the surface of the filter material. Depth filters are of the following types:

- **Candle filters:** These are made up of (a) diatomaceous earth (e.g., Berkefeld filters) or (b) unglazed porcelain (e.g., Chamberlain filters). They are available in different grades of porosity and are used widely for purification of water for drinking and industrial uses.
- **Asbestos filters:** These are made up of asbestos such as magnesium silicate. Seitz and Sterimat filters are the examples of such filters. These are disposable and single-use discs available in different grades. They have high adsorbing capacity and tend to alkalize the filtered fluid. Their use is limited by the carcinogenic potential of asbestos.
- **Sintered glass filters:** These are made up of finely powdered glass particles, which are fused together. They have low absorbing property and are available in different pore sizes. These filters, although can be cleaned easily, are brittle and expensive.

**2. Membrane filters:** Membrane filters are made up of (a) cellulose acetate, (b) cellulose nitrate, (c) polycarbonate, (d) polyvinylidene fluoride, or (e) other synthetic materials. These filters are now widely used and have replaced depth filters for last many years. These filters are circular porous membranes and are usually 0.1 mm thick. Although a wide variety of pore sizes (0.015–12  $\mu\text{m}$ ) are available, membranes with pores about 0.2  $\mu\text{m}$  are used, because the pore size is smaller than the size of bacteria. These filters are used to remove most vegetative cells, but not viruses, from solutions to be filtered. In the process of filtration, the membranes are held in special holders and often preceded by depth filters made of glass fibers to remove larger particles that might clog the membrane filter. The solution is then pushed or forced through the filter with a vacuum or with pressure from a syringe, peristaltic pump, or nitrogen gas bottle, and collected in previously sterilized containers.

## Key Points

Membrane filters remove microorganisms by screening them out in the way a sieve separates large sand particles from small ones. These filters have many uses:

- They are used to sterilize pharmaceutical substances, ophthalmic solutions, liquid culture media, oils, antibiotics, and other heat-sensitive solutions.
- They are used to obtain bacterial free filtrates of clinical specimens for virus isolation.
- They are used to separate toxins and bacteriophages from bacteria.

TABLE 3-2

Types and uses of radiation for sterilization

Types	Uses	Comments
Ionizing radiation administered using Cobalt-60-based instruments	For sterilization of pharmaceuticals like antibiotics, hormones, sutures; and prepacked disposable items, such as syringes, infusion sets, catheters, etc.	Though expensive and fraught with safety risks, it is very effective due to better penetration power
Nonionizing radiation administered through UV lamps	Only for disinfection of clear surfaces in OTs, laminar flow hoods, etc.	Hazardous and not as effective as ionizing radiation

Air also can be sterilized by filtration. Two common examples are surgical masks and cotton plugs on culture vessels that let air in but keep microorganisms out. Laminar flow biological safety cabinets are most widely used air filtration systems in hospitals and industries. In this method, air is passed through high-efficiency particulate air (HEPA) filters that remove nearly 99.97% of 0.3  $\mu\text{m}$  particles from the filtered air.

## Radiations

The ionizing and nonionizing radiations are the two types of radiation used for sterilization (Table 3-2).

- 1. Ionizing radiations:** Ionizing radiation is an excellent sterilizing agent with very high penetrating power. These radiations penetrate deep into objects and destroy bacterial endospores and vegetative cells, both prokaryotic and eukaryotic. These are, however, not that effective against viruses. Ionizing radiations include (a) X-rays, (b) gamma rays, and (c) cosmic rays. Gamma radiation from a cobalt-60 source is used for sterilization of antibiotics, hormones, sutures, catheters, animal feeds, metal foils, and plastic disposables, such as syringes. This has also been used to sterilize and “pasteurize” meat and other food items.

Irradiation usually kills *Escherichia coli* O157:H7, *Staphylococcus aureus*, *Campylobacter jejuni*, and other pathogens. Since there is no detectable increase of temperature in this method, this method is commonly referred to as “cold sterilization.” Both the Food and Drug Administration and the World Health Organization have approved food irradiation and declared it safe.

## Key Points

**Gamma radiation** from a cobalt-60 source is used for sterilization of antibiotics, hormones, sutures, catheters, animal feeds, metal foils, and plastic disposables such as syringes. This has also been used to sterilize and ‘pasteurize’ meat and other food items.

**2. Nonionizing radiations:** Nonionizing radiations include infrared and ultraviolet radiations.

- *Infrared radiations* are used for rapid and mass sterilization of disposable syringes and catheters.
- *Ultraviolet (UV) radiation* with wavelength of 240–280 nm is quite lethal and has a marked bactericidal activity. It acts by denaturation of bacterial protein and also interferes with replication of bacterial DNA.

UV radiation is used primarily for disinfection of closed areas in microbiology laboratory, inoculation hoods, laminar flow, and operating theaters. It kills most vegetative bacteria but not spores, which are highly resistant to these radiations. However, it does not penetrate glass, dirt films, water, and other substances very effectively.

Since UV radiations on prolonged exposure tend to burn the skin and cause damage to the eyes, UV lamps should be switched off while people are working in such areas.

### ► Sound (sonic) waves

High-frequency sound (*sonic*) waves beyond the sensitivity of the human ear are known to disrupt cells. Sonication transmits vibrations through a water-filled chamber (sonicator) to induce pressure changes and create intense points of turbulence that can stress and burst cells in the vicinity. Sonication also forcefully dislodges foreign matter from objects. Heat generated by the sonic waves (up to 80°C) also appears to contribute to the antimicrobial action.

Gram-negative rods are most sensitive to ultrasonic vibrations, while Gram-positive cocci, fungal spores, and bacterial spores are resistant to them. Ultrasonic devices are used in dental and some medical offices to clear debris and saliva from instruments before sterilization and to clean dental restorations. However, most sonic machines are not reliable for regular use in disinfection or sterilization.

Biological controls used for testing the efficacy of sterilization techniques are summarized in Table 3-3.

## Chemical Methods of Sterilization

Several chemical agents are used as antiseptics as well as disinfectants. All these chemical agents (e.g., alcohols, aldehydes, etc.) are described later in detail under disinfection.

**The effects of cold and desiccation:** The main benefit of cold treatment is to slow the growth of cultures and microbes in food during processing and storage. It is essential to know that

cold merely retards the activities of most microbes. Although it is true that cold temperatures kill some microbes, gradual cooling, long-term refrigeration, or deep-freezing does not adversely affect most of the microorganisms. In fact, freezing temperatures, ranging from  $-70$  to  $-135^{\circ}\text{C}$ , provide an environment that can preserve cultures of bacteria, viruses, and fungi for longer periods. Some psychrophiles grow very slowly even at freezing temperatures and can continue to secrete toxic products. *S. aureus*, *Clostridium* species (spore formers), *Streptococcus* species, and several types of yeasts, molds, and viruses are the pathogens that can survive for several months in the refrigerated food items.

### Key Points

**Lyophilization** is a process of freezing and drying. It is the most common method of preserving microorganisms and other cells in a viable state for many years. Pure cultures are frozen instantaneously and exposed to a vacuum that rapidly removes the water (it goes right from the frozen state into the vapor state). This method avoids the formation of ice crystals that would damage the cells. Although not all cells survive this process, lot many of them survive after reconstitution of lyophilized culture.

As a general rule, chilling, freezing, and desiccation are not considered as methods of disinfection or sterilization because their antimicrobial effects are erratic and uncertain, and one cannot be sure that pathogens subjected to these procedures have been killed.

## Disinfection

Disinfection is the process of inactivating microorganisms by direct exposure to chemical or physical agents. Differences between sterilization and disinfection have been summarized in Table 3-4.

- **Disinfectants** are products or biocides that destroy or inhibit the growth of microorganisms on inanimate objects or surfaces. Disinfectants can be sporistatic but are not necessarily sporicidal.
- **Antiseptics** are biocides or products that destroy or inhibit the growth of microorganisms in or on living tissue.

Antiseptics and disinfectants are used extensively in hospitals for a variety of topical and hard surface applications. They are an essential part of infection control practices and aid in the prevention of nosocomial infections.

## Properties of Ideal Disinfectant

An ideal disinfectant or antiseptic has the following characteristics:

1. Ideally, the disinfectant should have a wide spectrum of antimicrobial activity. It must be effective against a wide variety of infectious agents (Gram-positive and Gram-negative bacteria, acid-fast bacteria, bacterial endospores, fungi, and viruses) at high dilutions.

TABLE 3-3

**Biological controls used for testing efficacy of sterilization techniques**

Technique	Control organism
Autoclave	<i>Geobacillus stearothermophilus</i>
Hot-air oven	<i>Bacillus subtilis</i>
Ionizing radiations	<i>Bacillus pumilus</i>
Ethylene oxide	<i>Bacillus globigii</i> <i>Bacillus subtilis</i>

TABLE 3-4

**Differences between sterilization and disinfection**

	Sterilization	Disinfection
<b>Definition</b>	Freeing an article, surface, or medium from all living organisms including viruses, bacteria and their spores, and fungi and their spores.	Process that reduces the number of contaminating microorganisms, liable to cause infection to a level which is deemed no longer harmful to health. Spores are not killed.
<b>Uses</b>	Objects or instruments coming in direct contact with a break in skin or mucous membrane or entering a sterile body area.	Objects or instruments coming in direct contact with mucous membrane but tissue is intact or via intact skin.
<b>Examples</b>	Surgical instruments, needles, syringes, parenteral fluid, arthroscopes, media, reagents and equipments in laboratory use.	Endotracheal tubes, aspirators, gastroscopes, bed pans, urinals, etc.

2. It should act in the presence of organic matter.
3. It should not be toxic to human or corrosive. In practice, this balance between effectiveness and low toxicity for animals is hard to achieve. Some chemicals are used despite their low effectiveness, because they are relatively nontoxic.
4. It should be stable upon storage and should not undergo any chemical change.
5. It should be odorless or with a pleasant odor.
6. It should be soluble in water and lipids for penetration into microorganisms.
7. It should be effective in acidic as well as in alkaline media.
8. It should have speedy action.
9. If possible, it should be relatively inexpensive.

## Action of Disinfectants

Disinfectants act in many ways as discussed below.

1. They produce damage to the cell wall and alter permeability of the cell membrane, resulting in exposure, damage, or loss of the cellular contents.
2. They alter proteins and form protein salts or cause coagulation of proteins.
3. They inhibit enzyme action and inhibit nucleic acid synthesis or alter nucleic acid molecules.
4. They cause oxidation or hydrolysis.

## Factors Influencing Activity of Disinfectants

Various conditions influencing the efficiency of disinfectant are as follows:

- **Temperature:** Increase in temperature increases the efficiency of disinfectants.

- **Type of microorganism:** Vegetative cells are more susceptible than spores. Spores may be resistant to the action of disinfectants.
- **Physiological state of the cell:** Young and metabolically active cells are more sensitive than old dormant cells. Nongrowing cells may not be affected.
- **Environment:** The physical or chemical properties of the medium or substance influence rate as well as efficiency of disinfectants, e.g., pH of the medium and presence of extraneous materials.

## Types of Disinfectants

Disinfectants include the following: (a) phenolic compounds, (b) halogens, (c) alcohols, (d) aldehydes, (e) gases, (f) surface active agents, (g) oxidizing agents, (h) dyes, (i) heavy metals, and (j) acids and alkalis.

### ► Phenolic compounds

In 1867, Joseph Lister employed phenolic compounds to reduce the risk of infection during operations. Phenolic compounds are the most widely used antiseptics and disinfectants in laboratories and hospitals worldwide. They are bactericidal or bacteriostatic and some are fungicidal also. They act by denaturing proteins and disrupting cell membranes. They are effective in the presence of organic material and remain active on surfaces long after application. Different phenolic compounds are as follows:

- **Phenol:** It is effective against vegetative forms of bacteria, *Mycobacterium tuberculosis*, and certain fungi. It is an excellent disinfectant for feces, blood, pus, sputum, etc. It has a low degree of activity as compared to other derivatives. It is not suitable for application to skin or mucous membrane.
- **Cresol:** Cresols are more germicidal and less poisonous than phenol but corrosive to living tissues. They are used for cleaning floors (1% solution), for disinfection of surgical instruments, and for disinfection of contaminated objects. Lysol is a solution of cresols in soap.
- **Halogenated diphenyl compounds:** These compounds include hexachlorophene and chlorhexidine. They are highly effective against both Gram-positive and Gram-negative bacteria. They are used as skin antiseptics and for the cleaning of wound surfaces.

Hexachlorophene has been one of the most popular antiseptics because once applied it persists on the skin and reduces growth of skin bacteria for longer periods. However, it can cause brain damage and is now used in hospital nurseries only after a staphylococcal outbreak.

### ► Halogens

Halogens are fluorine, bromine, chlorine, and iodine—a group of nonmetallic elements that commonly occur in minerals, sea water, and salts. Although they can occur either in the ionic (halide) or nonionic state, most halogens exert their antimicrobial activity primarily in their nonionic state, but not in the halide state (e.g., chloride, iodide).

These agents are highly effective disinfectants and antiseptics, because they are microbicidal and not just microbistatic. They are also sporicidal with longer exposure. For these reasons, halogens are the active ingredients in nearly one-third of all antimicrobial chemicals currently marketed. Chlorine and iodine are the only two routinely used halogens because fluorine and bromine are dangerous to handle.

**Chlorine and its compounds:** Chlorine has been used for disinfection and antiseptics for approximately 200 years. The major forms used in microbial control are (a) liquid and gaseous chlorine and (b) hypochlorites. In solution, these compounds combine with water and release hypochlorous acid (HOCl), which oxidizes the sulfhydryl (S-H) group on the amino acid cysteine and interferes with disulfide (S-S) bridges on numerous enzymes. The resulting denaturation of the enzymes is permanent.

Gaseous and liquid chlorine are used almost exclusively for large-scale disinfection of drinking water, sewage, and wastewater from sources, such as agriculture and industry. Chlorine kills not only bacterial cells and endospores but also fungi and viruses. Treatment of water with chlorine destroys many pathogenic vegetative microorganisms without unduly affecting its taste. Chlorination at a concentration of 0.6–1.0 part of chlorine per million parts of water makes water potable and safe to use.

## Key Points

**Hypochlorites** are perhaps the most extensively used of all chlorine compounds. They are used for:

- Sanitization and disinfection of food equipment in dairies, restaurants, and canneries;
- Treatment of swimming pools, spas, drinking water, and even fresh foods;
- Treatment of wounds; and
- Disinfection of equipments, beddings, and instruments.

Common household bleach is a weak solution (5%) of sodium hypochlorite that is used as an all-around disinfectant, deodorizer, and stain remover. It is frequently used as an alternative to pure chlorine in treating water supplies. However, the major limitations of chlorine compounds are that they are:

- (a) Ineffective if used at an alkaline pH,
- (b) Less effective in the presence of excess organic matter, and
- (c) Relatively unstable, especially if exposed to light.

**Iodine and its compounds:** Iodine is a pungent black chemical that forms brown-colored solutions when dissolved in water or alcohol. Iodine rapidly penetrates the cells of microorganisms, where it apparently disturbs a variety of metabolic functions. It acts by interfering with the hydrogen and disulfide bonds of proteins (similar to chlorine). It kills all types of microorganisms if optimum concentrations and exposure times are used. Iodine activity, unlike chlorine, is not as adversely affected by organic matter and pH. The two primary iodine preparations are *free iodine in solution* and *iodophors*.

**Free iodine in solution:** Aqueous iodine contains 2% free iodine in solution and 2.4% sodium iodide. It is used as a topical

antiseptic before surgery and also occasionally as a treatment for burnt and infected skin. A stronger iodine solution (5% iodine and 10% potassium iodide) is used primarily as a disinfectant for plastic items, rubber instruments, cutting blades, and thermometers.

Iodine tincture is a 2% solution of iodine and sodium iodide in 70% alcohol that can be used in skin antiseptics. Because iodine can be extremely irritating to the skin and toxic when absorbed, strong aqueous solutions and tinctures (5–7%) are no longer considered safe for routine antiseptics.

Iodine tablets are available for disinfecting water during emergencies or for destroying pathogens in impure water supplies.

**Iodophors:** Iodophors are complexes of iodine and a neutral polymer, such as polyvinyl alcohol. This formulation permits the slow release of free iodine and increases its degree of penetration. These compounds have largely replaced free iodine solutions in medical antiseptics because they are less prone to staining or irritating tissues.

- Betadine, povidone, and isodine are the common iodophor compounds that contain 2–10% of available iodine. They are used to prepare skin and mucous membranes for surgery and in surgical hand scrubs.
- They are also used to treat burns and to disinfect equipments.
- A recent study has shown that betadine solution is an effective means of preventing eye infections in newborn infants, and it may replace antibiotics and silver nitrate as the method of choice.

## Alcohols

Alcohols are among the most widely used disinfectants and antiseptics. They are bactericidal and fungicidal but not sporicidal. They have no action against spores and viruses. Ethyl alcohol and isopropyl alcohol are the two most popular alcohol germicides. They are effective at a concentration of 60–70% in water. They act by denaturing bacterial proteins and possibly by dissolving membrane lipids. They are used as skin antiseptics. Isopropyl alcohol is used for disinfection of clinical thermometers. A 10–15 minute soaking is sufficient to disinfect thermometers. Methyl alcohol is effective against fungal spores.

## Aldehydes

Formaldehyde and glutaraldehyde are the two most commonly used aldehydes that are used as disinfectants. They are highly reactive molecules that combine with nucleic and alkylating molecules. They are sporicidal and can also be used as chemical sterilants.

**Formaldehyde:** Formaldehyde is usually dissolved in water or alcohol before use. In aqueous solution, it is bactericidal, sporicidal, and also effective against viruses. Formalin solution is 40% aldehyde in aqueous solution. It is used to:

- Preserve fresh tissue specimens,
- Destroy anthrax spores in hair and wool,
- Prepare toxoids from toxins,
- Sterilize bacterial vaccines, and
- Kill bacterial cultures and suspensions.

**Glutaraldehyde:** A 2% buffered solution of glutaraldehyde is an effective disinfectant. It is less irritating than formaldehyde and is used to disinfect hospital and laboratory equipments. Glutaraldehyde usually disinfects objects within time frame of 10 minutes but may require as long as 12 hours to destroy all spores. Glutaraldehyde is especially effective against tubercle bacilli, fungi, and viruses. It can be used for cleaning cystoscopes and bronchoscopes, corrugated rubber anesthetic tubes and face masks, plastic endotracheal tubes, metal instruments, and polythene tubing.

### ► Gases

Various gaseous agents are used for sterilization of large volume of heat-sensitive disposable items and also instruments. Ethylene oxide, formaldehyde gas, and betapropiolactone are frequently used gaseous agents.

**Ethylene oxide:** Ethylene oxide is a colorless liquid used for gaseous sterilization. It is active against all kinds of bacteria, spores, and viruses. It kills all types of microorganisms by inhibiting proteins and nucleic acids. It is both microbicidal and sporicidal. It is a highly effective sterilizing agent because it rapidly penetrates packing materials, including plastic wraps. It is used to sterilize disposable plastic Petri dishes, sutures, syringes, heart-lung machine, respirators, and dental equipments. Ethylene oxide is highly inflammable and carcinogenic. Extensive aeration of the sterilized materials is necessary to remove residual ethylene oxide gas, which is toxic.

**Formaldehyde gas:** The formaldehyde gas is used for (a) the fumigation of operation theaters, wards, sick rooms, and laboratories; and (b) the sterilization of instruments and heat-sensitive catheters, clothing and bedding, furniture, books, etc. The formaldehyde gas is produced by adding 150 gm of potassium permanganate to 280 mL formalin in 1000 cu ft of room volume. The room to be sterilized is completely closed and sealed at least for 48 hours after fumigation with formalin gas. Sterilization is achieved by condensation of gas on exposed surface. The gas is toxic when inhaled and is irritant to eye, hence its effect should be nullified by exposure to ammonia. It is highly inflammable and carcinogenic.

**Beta-propiolactone:** Beta-propiolactone (BPL) is a condensation product of ketone and formaldehyde. It is active against all microorganisms and viruses. It is more efficient than formaldehyde for fumigation purpose. In the liquid form, it has been used to sterilize vaccines and sera. BPL destroys microorganisms more readily than ethylene oxide but does not penetrate materials well and may be carcinogenic. For these reasons, BPL has not been used as extensively as ethylene oxide. Recently, vapor-phase hydrogen peroxide has been used to decontaminate biological wastes.

### ► Surface active agents

Surface active agents, such as detergents are the substances that alter energy relationship at interfaces producing a reduction in surface tension. Detergents are organic molecules that serve as wetting agents and emulsifiers because they have both polar hydrophilic and nonpolar hydrophobic

ends. Due to their amphipathic nature, detergents solubilize and are very effective cleansing agents. They are different from soaps, which are derived from fats. Surface active agents are of four types:

1. **Cationic surface active agents:** The cationic detergents are effective disinfectants. Cationic detergents like benzalkonium chloride and cetylpyridinium chloride kill most bacteria but not *M. tuberculosis*, endospores, or viruses. They do have the advantages of being stable and nontoxic, but they are inactivated by hard water and soap. These are often used as skin antiseptics and also as disinfectants for disinfection of food utensils and small instruments. Quaternary ammonium compounds, such as cetrime are the most popular cationic detergents. They act by disrupting microbial membranes and possibly by denaturing proteins.
2. **Anionic surface active agents:** These include soaps prepared either from saturated or unsaturated fatty acids, which act better at acidic pH. The soaps prepared from saturated fatty acids are more effective against Gram-negative organisms, whereas those prepared from unsaturated fatty acids are more active against Gram-positive bacilli and *Neisseria*.
3. **Nonionic surface active agents:** These are nontoxic and some of them may even promote the growth of bacteria.
4. **Amphoteric or ampholytic compounds:** These are active against a wide range of Gram-positive and Gram-negative bacteria and also against a few viruses. These are known as "Tego" compounds.

### ► Oxidizing agents

This group includes halogens, hydrogen peroxide, potassium permanganate, and sodium perborate. They are good disinfectants and antiseptics but are less effective in the presence of organic matter. Hydrogen peroxide, used as 3% solution, is a weak disinfectant. It is useful for cleaning of the wounds and for mouth wash or gargle. Potassium permanganate is bactericidal in nature and active against viruses also.

### ► Dyes

The dyes that have been used extensively as skin and wound antiseptics include (a) acridine dyes and (b) aniline dyes. The **acridine dyes** include acriflavine, euflavine, proflavine, and aminacrine. They show more activity against Gram-positive bacteria than against Gram-negative organisms. They act by interfering with the synthesis of nucleic acids and proteins in bacterial cells. The yellow acridine dyes, acriflavine and proflavine, are sometimes used for antiseptics and wound treatment in medical and veterinary clinics. **Aniline dyes** (such as gentian violet, crystal violet, and malachite green) are also more active against Gram-positive bacteria than against Gram-negative organisms. They are also effective against various fungi, hence are incorporated into solutions and ointments to treat fungal skin infections, such as ringworm.

The dyes, nevertheless, have limited applications because they stain and have a narrow spectrum of antimicrobial activity. They also have no activity against tubercle bacilli. Their actions are also inhibited by the presence of organic matter.



## ► Heavy metals

Soluble salts of mercury, silver, copper, arsenic, and other heavy metals have antibacterial activity, both bactericidal and bacteriostatic. They combine with proteins, often with their sulfhydryl groups and inactivate them. They may also precipitate cell proteins. Silver compounds are widely used as antiseptics. Silver sulfadiazine is used for burns. Silver nitrate is used as a prophylactic agent in ophthalmia neonatorum in newborn infants. Copper sulfate is an effective algicide in lakes and swimming pools. Mercuric chloride is used as disinfectant. These compounds, however, are increasingly replaced by other less toxic and more effective germicides.

## ► Acids and alkalis

Acids (such as sulfuric acid, nitric acid, hydrochloric acid, and benzoic acid) and alkalis (like potassium and sodium hydroxide and ammonium hydroxide) are germicidal in nature. They kill microorganisms by hydrolysis and altering the pH of the medium. They are rarely used as disinfectants.

Organic acids are widely used in food preservation because they prevent spore germination and bacterial and fungal growth, and because they are generally regarded as safe to eat. Acetic acid, in the form of vinegar, is a pickling agent that inhibits bacterial growth. Propionic acid is commonly added into breads and cakes to retard molds; lactic acid is added to sauerkraut and olives to prevent growth of anaerobic bacteria, especially the clostridia; and benzoic and sorbic acids are added to beverages, syrups, and margarine to inhibit yeasts.

Activities of commonly used disinfectants against various microorganisms are summarized in Table 3-5.

## Testing of Disinfectants

The efficiency of disinfectants can be determined with the help of several tests. These are:

- Phenol coefficient (Rideal–Walker) test
- Chick Martin test
- Capacity (Kelsey–Sykes) test
- In-use (Kelsey–Maurer) test

TABLE 3-5

Activities of commonly used disinfectants

Disinfectant	Fungi	Bacteria	Spores	Enveloped viruses	Nonenveloped viruses
Phenol	Good	Good	Nil	Good	Variable
Hypochlorite	Good	Good	Fair	Good	Good
Alcohols	Good	Good	Nil	Good	Variable
Aldehydes	Good	Good	Good	Good	Good
Glutaraldehyde	Good	Good	Good	Good	Good
Iodophor	Good	Good	Nil	Good	Good

## ► Phenol coefficient (Rideal–Walker) test

Rideal and Walker designed the phenol coefficient test to compare the performance of a disinfectant with that of phenol for the ability to kill *Salmonella typhi*. Phenol coefficient is determined by dilution of the disinfectant in question which sterilizes the suspension of *S. typhi* in a given time divided by the dilution of phenol which sterilizes the suspension in the same time.

In this test, a series of dilutions of phenol and the experimental disinfectant are inoculated with the test bacteria *S. typhi* and *S. aureus*, then placed in a 20°C or 37°C water bath. These inoculated disinfectant tubes are then subcultured on a regular fresh medium at 5 minute intervals, and the subcultures are incubated for two or more days. The highest dilutions that kill the bacteria after a 10 minute exposure, but not after 5 minutes, are used to calculate the phenol coefficient. The reciprocal of the appropriate test disinfectant dilution is divided by that for phenol to obtain the coefficient. Suppose that the phenol dilution was 1/90 and maximum effective dilution for disinfectant X tested was 1/450, then the phenol coefficient of X would be 5.

### Key Points

The higher the phenol coefficient value, the more effective the disinfectant under these test conditions. A value greater than 1 means that the disinfectant is more effective than the phenol. The test, however, does not show the action of disinfectant in natural conditions, i.e., in the presence of organic contaminants.

## ► Chick Martin test

It is a modification of Rideal–Walker test, in which the disinfectant acts in the presence of organic contaminants (e.g., dried yeast, feces, etc.) to simulate the natural conditions.

## ► Capacity (Kelsey–Sykes) test

The capacity (Kelsey–Sykes) test determines the appropriate use of dilutions of the disinfectants. It measures the capacity of a disinfectant to retain its activity when repeatedly used microbiologically. The disinfectant is assessed by its ability to kill bacteria by demonstrating growth or no growth on recovery culture media but not by comparison with phenol. The test is performed under both clean and dirty conditions, hence shows the effectiveness of a disinfectant in the presence of organic material.

## ► In-use (Kelsey–Maurer) test

The “in-use” (Kelsey–Maurer) test is a test that determines whether the chosen disinfectant is effective, in actual use, in hospital practice and also for the period of its use. The effectiveness of the disinfectant is determined by its ability to inactivate a known number of standard strain of a pathogenic staphylococci on a given surface within a certain given time. In-use test allows a more accurate determination of effectiveness of a disinfectant compared to phenol coefficient test.

# Culture Media

## Introduction

Laboratory diagnosis of an infection is usually confirmed by isolating and culturing microorganisms in artificial media. Bacteria and fungi are cultured in either liquid (broth) or on solid (agar) artificial media. Koch pioneered the use of agar as a base for culture media. He developed the pour plate method and was the first to use solid culture media for culture of bacteria. At first, Koch cultured bacteria on the sterile surfaces of cut, boiled potatoes. This was unsatisfactory, because bacteria would not always grow well on potatoes. He then tried to solidify regular liquid media by adding gelatin. Separate bacterial colonies developed after the surface had been streaked with a bacterial sample. The sample could also be mixed with liquefied gelatin medium. When the gelatin medium hardened, individual bacteria produced separate colonies. Despite its advantages, gelatin was not an ideal solidifying agent because it was digested by many bacteria and melted when the temperature rose above 28°C. A better alternative was provided by Fannie Eilshemius Hesse, the wife of Walther Hesse, one of Koch's assistants. She suggested the use of agar as a solidifying agent—she had been using it successfully to make jellies for sometime. Agar was not attacked by most bacteria and did not melt until it reaches a temperature of 100°C. One of Koch's assistants, Richard Petri, developed the Petri dish (plate), a container for solid culture media.

## Ingredients of Culture Media

The basic constituents of culture media include the following:

### Agar Agar or Agar

Agar is the main component that is used universally for preparation of solid media. It is obtained from a variety of sea weeds and after necessary processing is usually available as powder or as long shreds. Agar is chiefly composed of:

- A long-chain polysaccharide, consisting of D-galactopyranose units;
- A variety of inorganic salts, minute quantities of protein-like materials, traces of long-chain fatty acids; and
- Minerals, such as calcium and magnesium.

Agar is usually used in a concentration of 2–3%. Agar is hydrolyzed at high temperatures and at high acid or alkaline pH.

## Key Points

**Agar** has a unique property of melting at 98°C and solidifying at 42°C. The jellifying property of agar varies depending on the type of agar used (e.g., New Zealand agar is more jellifying than Japanese agar). Agar does not have any nutritive value and is also not affected by growth of bacteria.

## Peptone

Peptone is another important ingredient of culture media. It is a complex mixture of partially digested proteins. It is obtained by digestion of lean meat or other protein materials (such as heart muscle, casein, fibrin, or soya flour) with proteolytic enzymes (such as pepsin, trypsin, or papain).

## Key Points

- Peptone is an important source of nutrition for bacteria to grow.
- It contains peptones, proteoses, amino acids, inorganic salts (phosphates, potassium, and magnesium), and certain accessory factors, such as nicotinic acid and riboflavin.
- Neopeptone and proteose peptone are special types of peptone with high nutritive value.

## Other Ingredients

Other common ingredients of media include water, sodium chloride and other electrolytes, meat extract, yeast extract, malt extract, blood, and serum. Meat extract is available commercially as *Lab-Lemco* and contains inorganic salts, carbohydrates, certain growth factors, and protein degradation products. Blood or serum is usually used for enriching culture of bacteria. Usually, 5–10% defibrinated sheep or human blood is used.

## Types of Culture Media

Culture media can be classified in several ways:

### Liquid Media, Semisolid Media, and Solid Media

#### ► Liquid media

Liquid media provide greater sensitivity for the isolation of small numbers of microorganisms. Examples of liquid media

include nutrient broth, sugar media, and enrichment media. Composition and uses of some common liquid media are summarized in Table 4-1. Liquid media have the following disadvantages:

- Identification of mixed cultures growing in liquid media requires subculture onto solid media so that isolated colonies can be processed separately for identification.
- Growth in liquid media also cannot ordinarily be quantitated.
- Bacteria grown in liquid cultures often form colloidal suspensions.

► **Solid media**

Agar is used as a solidifying agent in most culture media. By varying the concentration of agar, it is possible to make the medium solid or semisolid. Solid media, though somewhat less sensitive than liquid media, provide isolated colonies that can be quantified and identified. Some genera and species can be recognized on the basis of their colony morphologies. Nutrient agar (Fig. 4-1) prepared by adding 2% agar to nutrient broth is the simplest and most common medium used routinely in diagnostic laboratories. Other examples of solid media include blood agar, chocolate agar, MacConkey agar, etc. Composition and uses of some common solid media are summarized in Table 4-2.

► **Semisolid media**

Addition of reduced concentration of agar (0.2–0.4%) makes the medium semisolid, which facilitates spread of the bacteria in the medium.

**Simple, Complex, Defined, and Special Media**

Simple, complex, defined, and special media are different types of media used for culture of the bacteria.

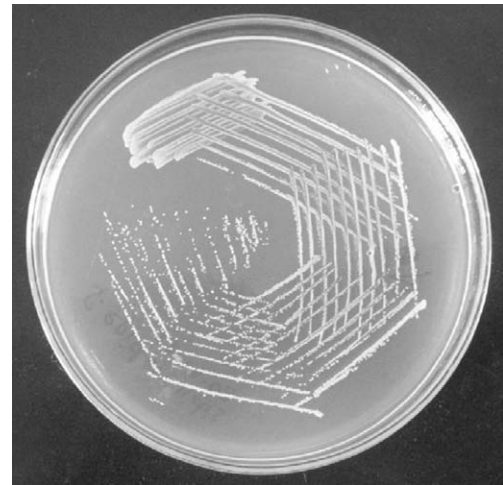

FIG. 4-1. Nutrient agar showing colonies of *Staphylococcus* spp.

TABLE 4-1

Composition and uses of some common liquid media

Medium	Composition	Uses
<b>Peptone water</b>	Peptone, sodium chloride, water	Routine culture, base for sugar fermentation test, indole test
<b>Nutrient broth</b>	Peptone water, meat extract	Routine culture
<b>Glucose broth</b>	Nutrient broth, glucose	Blood culture, culture of fastidious organisms, such as streptococci
<b>Brain heart infusion broth</b>	Sodium citrate, sodium chloride, sodium phosphate, dextrose peptone, brain and heart infusion broth (ox), sodium polyanethol sulfonate (SPS)	Whole blood, bone marrow, body fluid culture
<b>Alkaline peptone water</b>	Peptone water (pH 8.6)	Enrichment medium for <i>Vibrio</i>
<b>Selenite-F broth</b>	Peptone water, sodium selenite	Enrichment medium for feces for <i>Salmonella</i> and <i>Shigella</i>
<b>Tetrathionate broth</b>	Nutrient broth, sodium thiosulfate, calcium carbonate, iodine solution	Culture of feces for <i>Salmonella</i>
<b>Robertson's cooked meat (RCM) broth</b>	Nutrient broth, predigested cooked meat of ox heart	Anaerobic bacterial culture

TABLE 4-2

Composition and uses of some common solid media

Medium	Composition	Uses
<b>Nutrient agar</b>	Nutrient broth, agar 2%	Routine culture
<b>MacConkey medium</b>	Peptone, lactose, sodium taurocholate, agar, neutral red	Culture of Gram-negative bacteria, such as <i>Escherichia coli</i>
<b>Blood agar</b>	Nutrient agar, 5% sheep or human blood	Routine culture, culture of fastidious organisms, such as <i>Streptococcus</i> spp.
<b>Chocolate agar</b>	Heated blood agar	Culture of <i>Haemophilus influenzae</i> and <i>Neisseria</i>
<b>Deoxycholate citrate agar</b>	Nutrient agar, sodium deoxycholate, sodium citrate, lactose, neutral red, etc.	Culture of <i>Shigella</i> spp. and <i>Salmonella</i> spp.
<b>Thiosulfate citrate bile salt sucrose agar</b>	Thiosulfate, citrate, bile salt, sucrose, bromothymol blue, thymol blue	Culture of <i>Vibrio cholerae</i>
<b>Loeffler's serum slope</b>	Nutrient broth, glucose, horse serum	Culture of <i>Corynebacterium diphtheriae</i>
<b>Lowenstein-Jensen medium</b>	Coagulated hen's egg, mineral salt solution, asparagine, malachite green	Culture of <i>Mycobacterium tuberculosis</i>

## ► Simple media

The simple or basal media include nutrient broth and peptone water, which form the basis of other media.

- **Nutrient broth** is an example of a simple liquid medium that consists of peptone, meat extract, sodium chloride, and water. Addition of 0.5% glucose to nutrient broth makes it glucose broth.
- **Nutrient agar** is an example of a simple solid medium. The medium is used routinely for isolation of many bacteria from clinical specimens.

## ► Complex media

Most of the media other than basal media are usually known as complex media [e.g., chocolate agar, MacConkey agar, Robertson's cooked meat (RCM) medium, Lowenstein–Jensen (LJ) medium, etc.]. Complex media have some complex ingredients, which consist of a mixture of many chemicals in unknown proportions. This is an undefined medium, because the amino acid source contains a variety of compounds with the exact composition unknown. The complex media contain:

- Water,
- A carbon source such as glucose for bacterial growth,
- Various salts needed for bacterial growth, and
- A source of amino acids and nitrogen (e.g., beef and yeast extract).

## ► Defined media

A defined medium, also known as synthetic medium, contains known quantities of all ingredients. All the chemicals used are known, and it does not contain any animal, yeast, or plant tissue. These media consist of:

- Trace elements and vitamins;
- A defined carbon source and nitrogen source required by certain microbes. Glucose or glycerol is often used as carbon sources and ammonium salts or nitrates as inorganic nitrogen sources.

Dubos' medium with Tween 80 is an example of this medium.

## ► Special media

These include (a) enriched media, (b) enrichment media, (c) selective media, (d) indicator or differential media, (e) transport media, and (f) sugar media.

**Enriched media:** The enriched media are invariably solid media that facilitate growth of certain fastidious bacteria. These media are prepared by adding substances like blood, serum, and egg to the basal media in order to meet the nutritional requirements of more exacting and more fastidious bacteria. Blood agar (Color Photo 1), chocolate agar, Loeffler's serum slope (LSS), and LJ medium are some examples of enriched media. Blood agar is an enriched medium in which nutritionally rich whole blood supplements constitute the basic nutrients. Chocolate agar is enriched with heat-treated blood (80°C), which turns brown and gives the medium the color for which it is named.

**Enrichment media:** Enrichment media are liquid media that stimulate the growth of certain bacteria or suppress the growth of others for isolation of desired pathogenic bacteria. Commensal bacteria, such as *Escherichia coli* present in feces, tend to overgrow pathogenic ones in stool specimen. In such situations, enrichment media (such as selenite-F broth or tetrathionate broth) are used for the isolation of *Salmonella* Typhi and *Shigella* spp. from feces.

## Key Points

Enrichment media are useful for isolation of wanted bacteria from stool and other specimens containing more than one species of bacteria.

**Selective media:** These are solid media that contain substances that inhibit the growth of all but a few bacteria but at the same time facilitate isolation of certain bacteria. Some examples of selective media include:

- Thiosulfate citrate bile salt sucrose agar (TCBS) (Color Photo 35) selective for the isolation of *Vibrio cholerae*.
- Deoxycholate citrate agar (DCA) selective for enteric bacilli, such as *Salmonella* spp. and *Shigella* spp.
- LJ medium selective for *Mycobacterium tuberculosis*.
- Hektoen enteric (HE) agar selective for Gram-negative bacteria.
- Mannitol salt agar (MSA) selective for Gram-positive bacteria.
- Xylose lysine desoxycholate (XLD) agar selective for Gram-negative bacteria.
- Buffered charcoal yeast extract agar selective for certain Gram-negative bacteria, such as *Legionella pneumophila*.

Some selective media used in routine microbiology laboratories are summarized in Table 4-3.

**Differential or indicator media:** Differential or indicator media distinguish one microorganism from another growing on the same media by their growth characteristics.

## Key Points

**Differential or indicator media** depend on the biochemical properties of a microorganism growing in the presence of specific nutrients or indicators, such as neutral red, phenol red, eosin, or methylene blue. The medium changes color when a bacterium grows in them. For example, *S. typhi* grows as black colonies on Wilson and Blair medium containing sulfite. Lactose fermenting bacteria, such as *E. coli* produce pink colonies (Color Photo 2), whereas nonlactose fermenting bacteria, such as *Salmonella* spp. form pale or colorless colonies on MacConkey agar. Fermentation of lactose in the medium makes it acidic and leads to the formation of pink colonies in the presence of neutral red.

Examples of differential media include:

- Eosin methylene blue (EMB), differential for lactose and sucrose fermentation;
- MacConkey, differential for lactose fermentation;

TABLE 4-3

## Some selective media used in routine microbiology laboratories

Medium	Colony characteristics		Organisms inhibited
<b>Mannitol salt agar</b>	Big yellow colonies of <i>Staphylococcus aureus</i>	Small pink colonies of <i>Staphylococcus epidermidis</i>	<i>Streptococcus</i> spp.
<b>Thayer–Martin medium</b>	Gray colonies of <i>Neisseria meningitidis</i> and <i>Neisseria gonorrhoeae</i>		Gram-positive cocci
<b>MacConkey agar medium</b>	Lactose fermenters: red colonies, e.g., <i>Escherichia coli</i>	Lactose nonfermenters: colorless colonies of <i>Salmonella</i> spp.	Gram-positive cocci
<b>Thiosulfate citrate bile salt sucrose agar</b>	Sucrose fermenter: yellow colonies of <i>Vibrio cholerae</i>	Sucrose nonfermenters: green colonies of <i>Vibrio parahaemolyticus</i>	Enteric bacilli
<b>Charcoal yeast extract</b>	Cut glass colonies of <i>Legionella</i> spp.		Gram-positive cocci
<b>Lowenstein–Jensen medium</b>	Rough, tough, and buff colonies of <i>Mycobacterium tuberculosis</i>	Smooth and pigmented colonies of atypical <i>Mycobacterium</i> spp.	Cocci
<b>Sabouraud’s dextrose agar</b>	Most fungi		Most bacteria

- Mannitol salt agar (MSA), differential for mannitol fermentation; and
- X-gal plates, differential for lac operon mutants for detection of recombinant strains of bacteria for study in molecular biology.

**Transport media:** Transport media are used to maintain the viability of certain delicate organisms in clinical specimens during their transport to the laboratory. They typically contain only buffers and salt. They lack carbon, nitrogen, and organic growth factors, hence do not facilitate microbial multiplication. Examples of transport media are Stuart’s transport medium for *Neisseria gonorrhoeae*.

**Sugar media:** Sugar media, basically contains 1% “sugar”, which in microbiology denotes any fermentable substance, such as glucose, sucrose, lactose, and mannitol that is routinely used for fermentation tests. The sugar media shows the following characteristics:

- It consists of 1% sugar in peptone
- The indicator used in sugar media is Andrade’s indicator that consists of 0.005% acid fuchsin in 1 N NaOH. The production of acid after fermentation of sugar is indicated by the change of color of the medium to pink due to the presence of indicator.
- Durham’s tube is kept inverted inside the sugar tube to demonstrate the production of gas. Production of gas is indicated by the demonstration of gas bubble in Durham’s tube.

Nowadays, dehydrated media are available for wide use in diagnostic laboratories because of simplicity of procedure and being less cumbersome to prepare. These dehydrated media are prepared by simply reconstituting in distilled water and sterilizing it before use.

# Culture Methods

## Introduction

Culture methods are very crucial in a microbiology laboratory. Various culture methods are carried out to:

1. Isolate bacteria in pure culture and identify the same by performing various tests.
2. Demonstrate biochemical, antigenic, and other phenotypic and genomic properties of the isolated colonies.
3. Demonstrate susceptibility of the isolated bacteria to antibiotics, bacteriophages, bacteriocins, etc.
4. Prepare antigens for various uses.
5. Maintain stock culture.

## Methods of Culture

Various methods are used for culturing of bacteria. These include (a) streak culture, (b) lawn culture, (c) pour-plate culture, (d) stroke culture, (e) stab culture, and (f) liquid culture.

### Streak Culture

Streak culture is the most useful method for obtaining discrete colonies of the bacteria. It is carried out by streaking on the surface of a solid media plate using a platinum or nichrome loop of 2–4 mm diameter. In this method, a loopful of the inoculum is placed near the peripheral area of the plate. The inoculum is then spread with the loop to about one-fourth of the plate with close parallel strokes. From the primary inoculum, it is spread thinly over the plate by streaking with the loop in parallel lines. The loop is flamed and cooled in between the streaks to obtain isolated colonies. The inoculated culture plate is incubated at 37°C overnight for demonstration of colonies. Confluent growth occurs at the primary inoculum, but becomes progressively thinner, and well-separated colonies are demonstrated on the final streaks of the inoculum (Fig. 5-1). Single isolated colonies obtained by this method are very useful to study various properties of bacteria. Streak culture is the most useful method for obtaining discrete colonies of the bacteria.

### Lawn Culture

The lawn culture provides a uniform layer of bacterial growth on a solid medium. It is carried out by flooding the surface of the solid media plate with a liquid culture or suspension of bacteria, pipetting off the excess inoculum, and finally

incubating the plate overnight at 37°C. Alternatively, the culture plate may be inoculated by a sterile swab soaked in liquid bacterial culture or suspension and incubating overnight for demonstration of the bacterial colonies.

## Key Points

Lawn culture method is useful:

- To carry out antibiotic sensitivity testing by disc diffusion method;
- To carry out bacteriophage typing; and
- To produce a large amount of bacterial growth required for preparation of bacterial antigens and vaccines.

## Pour-Plate Culture

The pour-plate culture is used to determine approximate number of viable organisms in liquids, such as water or urine. It is used to quantitate bacteria in urine cultures and also to estimate the viable bacterial count in a suspension. This method is carried out in tubes, each containing 15 mL of molten agar. The molten agar in tubes is left to cool in a water bath at 45°C. The inoculum to be tested is diluted in serial dilution. Then 1 mL each of diluted inoculum is added to each tube of molten agar and mixed well. The contents of tubes are poured into sterile Petri dishes and allowed to set. After overnight incubation of these Petri dishes at 37°C, colonies are found to be distributed throughout the depth of the medium, which can be counted using a colony counter.

## Stroke Culture

Stroke culture provides a pure growth of bacteria for carrying out slide agglutination and other diagnostic tests. It is carried out in tubes usually containing nutrient agar slopes.

## Stab Culture

Stab culture is prepared by stabbing the medium in tubes with a long, straight wire and incubating at 37°C.

## Key Points

Stab culture is frequently used for:

- Maintaining stock cultures.
- Demonstration of oxygen requirement of bacteria.
- Demonstration of gelatin liquefaction of bacteria.

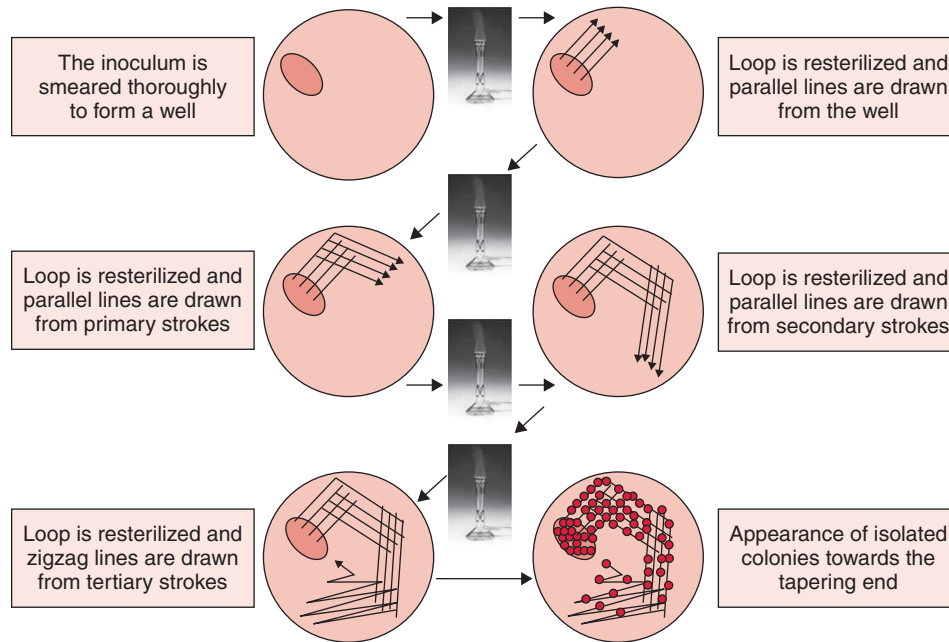

FIG. 5-1. Diagrammatic representation showing streak culture.

## Liquid Culture

Liquid culture is prepared in a liquid media enclosed in tubes, flasks, or bottles. The medium is inoculated by touching with a charged loop or by adding the inoculum with pipettes or syringes and incubating at 37°C, followed by subculture on to solid media for final identification.

### Key Points

#### Liquid culture is specifically used:

- For blood culture and for sterility tests, where the concentration of bacteria is expected to be small;
- For culture of specimens containing antibiotics and other antibacterial substances, as these are rendered ineffective by dilutions in the medium; and
- When large yields of bacteria are required.

A major disadvantage of liquid culture is that it does not provide pure culture of the bacteria and also the bacterial growth does not exhibit special characteristic appearances.

## Anaerobic Culture

Obligate anaerobes are bacteria that can live only in the absence of oxygen. These anaerobes are killed when exposed to the atmosphere for as briefly as 10 minutes. Some anaerobes are tolerant to small amounts of oxygen. Facultative anaerobes are those anaerobes that grow with or without oxygen.

Anaerobic bacterial culture is a method used to grow anaerobes from a clinical specimen. Culture and identification of anaerobes is essential for initiating appropriate treatment.

The failure to do so may have serious consequences, such as amputation, organ failure, sepsis, meningitis, and even death.

## Specimen Collection

Specimens frequently used for anaerobic culture include:

- Blood, bile, bone marrow, cerebrospinal fluid, direct lung aspirate, and tissue biopsy from a normally sterile site;
- Fluid aspirated from a normally sterile site, such as a joint;
- Pus specimens from dental abscess, burn wound, abdominal or pelvic abscess; and
- Specimens from knife, gunshot, or surgical wounds.

Collection of a contamination-free specimen and protecting it from oxygen exposure during collection form the mainstay of anaerobic culture. The specimens need to be obtained from an appropriate site without contaminating the sample with bacteria from the adjacent skin, mucous membrane, or tissue.

Abscesses or fluids are usually collected by using a sterile syringe and is then tightly capped to prevent entry of air. Tissue samples are placed into a degassed bag and sealed, or into a gassed out screw top vial that may contain oxygen-free prerduced culture medium and tightly capped. The specimens need to be plated as rapidly as possible onto culture media for isolation of bacteria.

### Key Points

- Swabs are always avoided when collecting specimens for anaerobic culture because cotton fibers may be detrimental to anaerobes.
- Coughed throat discharge (sputum), rectal swab, nasal or throat swab, urethral swab, and voided urine are some of the specimens that are not suitable for processing anaerobic cultures.

## Culture Media

The commonly used media for anaerobic culture include Robertson cooked meat broth, thioglycollate broth, Willis and Hobbs' media, and neomycin blood agar. Robertson cooked meat (RCM) broth is the most widely used medium in an anaerobic culture. It consists of nutrient broth and pieces of fat-free minced cooked meat of ox heart with a layer of sterile liquid paraffin over it. Unsaturated fatty acids and even glutathione and cysteine present in the meat extract utilize oxygen for auto-oxidation. The medium before inoculation is usually boiled at 80°C in a water bath to make the medium free of oxygen. The media after inoculation and incubation allows the growth of even strict anaerobes and also indicates their saccharolytic or proteolytic activities as meat is turned red or black, respectively.

## Methods of Anaerobic Culture

Anaerobic cultures are carried out in an environment that is free of oxygen, followed by incubation at 95°F (35°C) for at least 48 hours before the plates are examined for growth. The cultures of anaerobic bacteria are carried out as follows:

1. **McIntosh–Fildes anaerobic jar:** It is the most widely used and dependable method of anaerobiosis (Color Photo 3). It consists of a glass or metal jar with a metal lid that can be clamped air tight with the help of a screw. The lid has one inlet tube and another outlet tube. The outlet tube is connected to a vacuum pump by which the air is evacuated out of the jar. The inlet tube is connected to a source of hydrogen supply. The lid has two electric terminals also that can be connected to an electric supply. The underside of the lid contains a catalyst (e.g., alumina pellets coated with palladium) that catalyzes the combination of hydrogen with residual oxygen present in the air. This method ensures complete anaerobiosis.

The culture media are inoculated with the specimens suspected to contain anaerobic bacteria. The inoculated media are then kept inside the jar, and the lid is closed air tight. The anaerobiosis in the jar is carried out by first evacuating the air from the jar through outlet tube with the help of a vacuum pump. The outlet tube is closed, then the sealed jar containing the culture plates is replaced with hydrogen gas passed through inlet tube till reduced atmospheric pressure is brought to normal atmospheric pressure, which is monitored on the vacuum gauge as zero. The electrical terminals are then switched on to heat

the catalyst that catalyzes combination of hydrogen with residual oxygen and ensures complete anaerobiosis in the jar.

Reduced methylene blue is used as the indicator of anaerobiosis in the jar. If anaerobiosis is complete, it remains colorless; if anaerobiosis is not complete, it turns blue on exposure to oxygen.

**Gas pack system** is a simple and effective method of production of hydrogen gas for anaerobiosis. It does not require the cumbersome method of evacuation and filing up of gases after evacuation. Carbon dioxide, which is also generated, is required for growth by some anaerobes. Water activates the gas pack system, resulting in the production of hydrogen and carbon dioxide. Hydrogen combines with oxygen in the air in the presence of catalyst and maintains anaerobiosis. In this method, the inoculated plates are kept along with the gas pack envelope with water added in the air tight jar.

## Key Points

It is the method of choice for preparing anaerobic jars. It is commercially available as a disposable envelope containing chemicals that produce hydrogen and carbon dioxide on addition of water.

2. **Anaerobic glove box:** The anaerobic glove box is another innovation developed for isolating anaerobic bacteria. It is essentially a large clear-vinyl chamber with attached gloves, containing a mixture of 80% nitrogen, 10% hydrogen, and 10% carbon dioxide. A lock at one end of the chamber is fitted with two hatches, one leading to outside and the other to the inside of the chamber. Specimens are placed in the lock, the outside hatch is closed, and the air in the lock is evacuated and replaced with the gas mixture. The inside hatch is then opened to introduce the specimen into the chamber.
3. **Anoxomat:** This is a fully automated system that evacuates a portion of the jar contents and refills the jar with an anaerobic gas mixture. During this procedure, the oxygen concentration in the air is rarefied. For anaerobic atmosphere, this procedure is repeated three times, after which the oxygen concentration is rarefied to 0.16%. A small catalyst removes this very small percentage of oxygen content. Anoxomat is capable of producing micro-aerophilic conditions also. The method is being increasingly used for processing clinical specimens for isolation of anaerobic bacteria.



# Laboratory Identification of Bacteria and Taxonomy

## 6

### Introduction

It is not always possible to identify microorganisms by microscopic methods alone, due to similarity of bacteria in their morphology and staining characters. Hence, further study of microorganisms is essential for their identification. For this purpose, organisms have been grown artificially in the laboratory.

### Identification of Bacteria

The complete identification of bacteria involves the following steps: (a) morphology of bacterial colony on solid medium, (b) growth in liquid medium, (c) biochemical reactions, (d) antigenic structures, (e) animal pathogenicity, (f) antibiotic sensitivity, (g) typing of bacterial strains, (h) rapid identification methods, and (i) molecular methods.

### Morphology of Bacterial Colony on Solid Medium

Morphology of the bacterial colony on solid medium depends on a number of factors, such as nature of culture medium, temperature and time of incubation, age of culture, and number of subcultures done. The characteristics noted are shape, size, surface, edge, elevation, opacity, color, and hemolysis of the colonies, as follows:

- The colonies may be a few millimeters in size: pinhead size (*Staphylococcus aureus*) or pinpoint (streptococci).
- The shape may be circular or irregular, and surface of the colonies may be smooth, rough, or granular.
- The colonies on the medium may be flat, raised, low convex, convex, or umbonate.
- The edge may be entire, lobate, crenated, undulate, or ciliate.
- The colonies may be transparent, translucent, or opaque.
- Certain bacterial colonies are associated with production of pigments and hemolysis around them.

### Growth in Liquid Medium

Nutrient broth and peptone water are frequently used as liquid media for growth of bacteria. The characteristics of bacterial growth in liquid media provide some clue in presumptive identification. For example, streptococci produce granular deposits

at the bottom of the liquid medium, whereas most of the Gram-negative bacteria produce uniform turbidity. *Pseudomonas* spp. and other aerobic bacteria tend to produce surface pellicles in liquid media. The pigment production of some bacteria, such as *Pseudomonas aeruginosa* can be appreciated in liquid media.

Smears prepared on glass slides from bacterial colonies grown on either solid or liquid media are examined for bacteria by appropriate staining. Gram staining is most widely used to differentiate between Gram-positive and Gram-negative bacteria. Ziehl-Neelsen stain differentiates acid-fast bacilli (e.g., *Mycobacterium tuberculosis*, *Mycobacterium leprae*, etc.) from nonacid-fast bacilli (Fig. 6-1). Albert's stain is used to demonstrate metachromatic granules in *Corynebacterium diphtheriae*.

### Biochemical Reactions

Biochemical reactions are very important in the identification of bacterial isolates and in the identification of different bacterial species. These tests depend on the presence of certain enzymes, such as catalase, oxidase, urease, gelatinase, etc., produced by the bacteria. Commonly used biochemical tests are described below:

#### ► Catalase test

Catalase test is used to detect the presence of enzyme catalase in a bacterium. The enzyme catalase catalyzes the breakdown of hydrogen peroxide with the release of free oxygen. It is found in most aerobic and facultative anaerobic bacteria. The main exception is *Streptococcus* spp. It is not found in anaerobes.



**FIG. 6-1.** Ziehl-Neelsen staining to differentiate acid-fast bacilli from nonacid-fast bacilli.

Red blood cells contain catalase and their presence, therefore, gives a false positive result.

Catalase test is primarily used to differentiate *Staphylococcus* and *Streptococcus*. In this test, a small amount of culture to be tested is picked up from a nutrient agar plate with a sterile platinum loop or glass rod and this is inserted into hydrogen peroxide solution (3%) held on a slide or in a tube. Immediate production of air bubbles in the solution denotes a positive test and no bubbles indicate a negative test.

### ► Oxidase test

This test determines the presence of enzyme oxidase in many bacteria. The enzyme oxidase catalyzes the oxidation of reduced cytochrome by molecular oxygen. Kovac's oxidase reagent that contains tetramethyl-*p*-phenylenediamine dihydrochloride is the main reagent used in the oxidase test. The dye serves as an alternate substrate for the cytochrome oxidase reaction. In the reduced state, the reagent is colorless but when oxidized, it becomes purple. Oxidase test can be performed by several methods that include:

- Dry filter paper method,
- Wet filter paper method, and
- Plate method.

The dry filter paper method is performed by impregnating strips of filter paper with 1% Kovac's oxidase reagent. The paper is smeared with the bacterial colonies to be tested by a glass rod. In a positive test, the smeared area on the filter paper turns deep purple within 10 seconds. No color change indicates negative test (Color Photo 4).

### Key Points

Oxidase-positive bacteria include *Neisseria* spp., *Vibrio* spp., *Aeromonas* spp., *Plesiomonas* spp., *Pseudomonas* spp., and *Moraxella* spp. Oxidase-negative bacteria include all members of the family Enterobacteriaceae.

### ► Indole test

Indole test is used to detect the ability of bacteria to decompose amino acid tryptophan to indole, which accumulates in the medium. Tryptophan or peptone broth is the medium used for indole test (Color Photo 5). The test is performed by inoculating the medium with bacteria, incubating at 37°C for 24–48 hours. Then, 5 drops of Kovac's reagent containing amyl or isoamyl alcohol, *p*-dimethyl amino benzaldehyde, and concentrated hydrochloric acid are added to the inoculated medium. Positive test is indicated by formation of a red ring at the surface of the medium. No color change indicates a negative test (Fig. 6-2).

Precautions in interpretation of indole test are as follows: (a) cultures to be tested for indole production need to be incubated aerobically and (b) the optimum pH for tryptophanase activity is alkaline (pH 7.4–7.8), hence a decrease in pH results in decreased indole production and gives a possible false negative reaction.

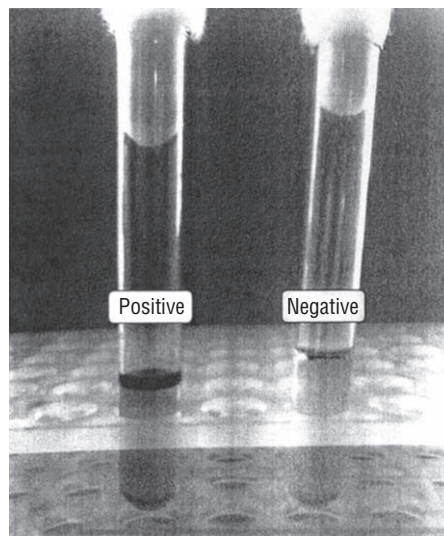

FIG. 6-2. Indole test.

### Key Points

Indole-positive bacteria are *Escherichia coli*, *Vibrio cholerae*, *Proteus vulgaris*, and *Edwardsiella* spp. Indole-negative bacteria are *Salmonella typhi*, *Klebsiella* spp., and *P. mirabilis*.

### ► Carbohydrate fermentation test

Carbohydrate fermentation test is done to determine the ability of a bacterium to ferment a specific carbohydrate incorporated in a basal medium, producing acid or acid with visible gas. The carbohydrates include glucose, lactose, sucrose, maltose, etc. The sugar medium contains 1% sugar. Andrade's indicator is a solution of acid fuchsin to which sodium hydroxide is added. It is a pH indicator that is added to the basal medium, which indicates the formation of organic acids.

The test is performed by inoculating the sugar media with bacteria, incubating at 37°C for 18–24 hours. The change of the color to pinkish red (acidic) is considered as a positive test result, whereas yellow to colorless (alkaline) sugar indicates negative test result. Production of gas is indicated by appearance of gas bubbles in Durham's tube.

### Key Points

All members of the family Enterobacteriaceae ferment glucose, whereas glucose and mannitol are fermented by *Salmonella* spp., and glucose and lactose are fermented by *E. coli* and *Klebsiella* spp.

### ► Oxidation–fermentation test

Oxidation–fermentation test (OF test) determines the oxidative or fermentative metabolism of a carbohydrate by a bacterium. The OF test is used to determine whether a bacterium has the enzymes necessary for the aerobic breakdown of glucose

(i.e., oxidation) and/or for the fermentation of glucose. The test differentiates Enterobacteriaceae (fermenters) from the members of the family Pseudomonadaceae (the nonfermenters).

### ► Kligler's iron agar/triple sugar iron agar test

Kligler's iron agar (KIA) and triple sugar iron agar (TSI) tests are used to determine the ability of an organism to attack a specific carbohydrate incorporated into a basal growth medium, with or without the production of gas, along with production of hydrogen sulfide. KIA medium contains two carbohydrates: lactose and glucose in a ratio of 10:1. TSI contains a third carbohydrate, i.e., sucrose, in addition to lactose and glucose.

The test is performed by inoculating KIA or TSI with an inoculating needle by stabbing the butt and streaking the slant and then incubating at 37°C for 18–24 hours. During incubation, the bacterium first utilizes glucose and then lactose and sucrose. After 18–24 hours, the glucose concentration is depleted in the slant and in the butt. The bacteria start oxidative degradation of the peptone present in the slant, resulting in the production of alkaline by-products, thereby changing the indicator to a red color. Anaerobic fermentation of glucose in the butt produces a large volume of acid, which neutralizes the alkalinity caused by peptone degradation; hence the butt continues to remain yellow. Yellow color (acidic), therefore, indicates fermentation of carbohydrates and red color (alkaline) indicates no fermentation. Presence of bubble in the butt indicates production of gas during fermentation of carbohydrates.

Certain bacteria produce H<sub>2</sub>S, which is detected as black precipitate that blackens the slant and butt of the medium. The medium is turned black due to combination of H<sub>2</sub>S with ferric ions, from ferric salts present in the medium, to form ferrous sulfide as black precipitates.

Three basic fermentation patterns are observed on KIA medium after incubation at 37°C for 24 hours:

- 1. Fermentation of glucose only (alkali/acid or K/A reaction; K denotes alkaline reaction and A denotes acidic reaction):** After 18–24 hours, the low glucose concentration is completely used up, and the organism starts to utilize the peptones present in the medium, resulting in an alkaline pH in slant (red). In the butt, a yellow color exists due to anaerobic degradation of glucose.
- 2. Fermentation of lactose and glucose (acid/acid or A/A reaction):** Lactose is present in 10 times the amount of glucose. In 18–24 hours, the lactose is not depleted and therefore acidic conditions exist in the butt and slant.
- 3. Neither lactose nor glucose fermented (alkali/alkali or K/K reaction):** Many Gram-negative, nonenteric bacilli are unable to ferment glucose or lactose. A reaction of K/K is a result of aerobic catabolism of peptone by the organism.

H<sub>2</sub>S production and carbohydrate fermentation patterns are generally characteristic for specific bacterial groups, especially the Enterobacteriaceae.

### ► Urease test

Urease test is used to determine the ability of an organism to split urea to ammonia by the enzyme urease. Production of ammonia makes the medium alkaline; thus the indicator phenol red changes to red or pink in color.

The test is performed in Christensen's urease medium. The medium is inoculated with the bacterial colony and incubated at 37°C. Urease-positive bacteria produce a pink color.

### Key Points

Urease test is useful for screening the production of urease by *Proteus* spp., *Morganella* spp., and some *Providencia* spp. *Proteus* spp. is rapidly urease positive—usually within 6 hours. Another example of urease producing organism is *Helicobacter Pylori*, the production of which is essential for its survival in the acidic pH of the stomach.

### ► Citrate test

Citrate test is used to demonstrate the ability of an organism to utilize citrate as the sole source of carbon for metabolism. Koser's citrate medium (a liquid medium) and Simmon's citrate medium (a solid medium) are used for the test. In this test, either of the medium is inoculated with the bacteria and then incubated at 37°C overnight. Growth on the Simmon's medium is accompanied by a rise in pH to change the medium from its initial green color to deep blue. Hence, growth with blue color on the slant indicates positive test and no growth without any color change indicates negative test. The medium needs to be lightly inoculated (from plate cultures, not from a broth) to avoid a carryover of nutrients, which may lead to a false positive result. In Koser's liquid medium, turbidity indicates positive test and absence of turbidity indicates negative test.

### ► Phenylalanine deaminase test

Phenylalanine deaminase test indicates the ability of an organism to deaminate phenylalanine to phenylpyruvic acid (PPA), which reacts with ferric salts to give green color. This test is also called PPA test. The test is performed by inoculating the medium containing phenylalanine by the bacteria. After overnight incubation at 37°C, a few drops of 10% ferric chloride solution are added to the inoculated medium. If PPA is produced, the medium becomes green in color due to combination of ferric chloride with PPA, which indicates a positive test. Absence of any color change indicates a negative test. PPA-positive bacteria are *Proteus* spp., *Providencia* spp., and *Morganella* spp.

### ► Nitrate reduction test

Nitrate reduction test is used to determine the presence of enzyme nitrate reductase in the bacteria. The enzyme reduces nitrate to nitrites or free nitrogen gas. The test is carried out by inoculating the broth containing 1% potassium nitrate (KNO<sub>3</sub>) and incubating at 37°C up to 5 days. Then 1–2 drops of a reagent that consists of a mixture of 1 mL of naphthylamine

and 1 mL of sulfanilic acid is added. Red color developing within a few minutes signifies positive reaction, while absence of color indicates negative reaction.

### Key Points

Nitrate reduction test is used mainly for the identification of members of the family Enterobacteriaceae, which are usually positive for nitrate reduction test.

### ► Methyl red test

Methyl red (MR) test detects the ability of an organism to produce and maintain stable acid end products during the fermentation of glucose, thereby maintaining a sustained pH below 4.5. The test is performed by inoculating a glucose phosphate broth and incubating it at 37°C for 2–5 days. Five drops of 0.04% of MR solution are then added to the inoculated medium, mixed, and the result is read immediately. Development of red color denotes a positive test, and yellow color indicates negative test. *E. coli*, *Yersinia* spp., and *Listeria monocytogenes* are the examples of MR-test-positive bacteria.

It should be noted that if the MR test is performed too early, the results may produce a false positive reaction. This is because MR-negative organisms may not have adequate time to completely metabolize the initial acid products that have been produced during the fermentation of glucose.

### Key Points

Methyl red test is commonly used to differentiate *E. coli* (MR positive) from *Enterobacter* (MR negative) and *Yersinia* spp. (MR positive) from other Gram-negative, non-enteric bacteria (MR negative).

### ► Voges–Proskauer test

Voges–Proskauer (VP) test detects the production of acetyl methyl carbinol (acetoin), a natural product formed from pyruvic acid in the course of glucose fermentation. The acetoin, in the presence of alkali and atmospheric oxygen, is oxidized to diacetyl that reacts with alpha-naphthol to produce red color. This test is performed by inoculating the glucose phosphate broth with the organism and incubating at 37°C for 48 hours. Then approximately 3 drops of alpha-naphthol is added followed by addition of 1 drop of 40% potassium hydroxide. The reagents are mixed well and are allowed to stand for 30 minutes. In positive test, pink color appears in 2–5 minutes, deepening to magenta in half an hour. The solution remains colorless for 30 minutes in negative test.

*Staphylococcus* spp., *V. cholerae* biotype eltor, *Klebsiella* spp., and *Enterobacter* spp. are the common examples of VP-test-positive bacteria.

### Key Points

Indole, MR, VP, and citrate test commonly referred to as “IMViC tests” are the most frequently used tests in the identification of enteric, Gram-negative bacteria.

### ► Hydrogen sulfide production

These tests are carried out to demonstrate H<sub>2</sub>S produced by certain bacteria. Production of H<sub>2</sub>S is demonstrated by inoculating the bacteria in the media containing lead acetate, ferric ammonium citrate, or ferrous acetate and incubating overnight at 37°C. H<sub>2</sub>S-producing bacteria by their enzymatic actions produce H<sub>2</sub>S from sulfur-containing amino acids in the medium. Production of sulfur produces black color in the media, visible to the naked eye.

Filter paper strip is another method of demonstration of production of H<sub>2</sub>S. In this method, filter paper strip impregnated with lead acetate is kept between the cotton plug and the medium in the tube. Production of H<sub>2</sub>S is indicated by blackening of the paper.

*P. mirabilis*, *P. vulgaris*, and *Salmonella* spp. are some examples of the H<sub>2</sub>S-producing bacteria.

### Antigenic Structures

Agglutination of biochemically confirmed bacteria with specific antisera facilitates further identification of the isolated bacteria. Agglutination test is used in the identification of presumptive isolates of pathogens (e.g., *Salmonella*) from clinical samples. It is also used for the grouping of beta-hemolytic streptococci.

### Animal Pathogenicity

Some pathogenic bacteria and their bacterial metabolites produce characteristic lesions in laboratory animals. The most commonly employed animals are rats, guinea pigs, mice, and rabbits. These animals, depending on the organisms to be tested, may be inoculated by subcutaneous, intramuscular, intravenous, intraperitoneal, or intracerebral routes. The identification of the bacteria is made depending on the postmortem findings and cultural properties of the bacteria. For example, guinea pigs are commonly used for performing animal pathogenicity of *C. diphtheriae*, *Clostridium perfringens*, and *M. tuberculosis*.

### Antibiotic Sensitivity

Determination of antibiotic sensitivity of an isolate from a patient is essential for the choice of drug therapy. In some cases, sensitivity of an organism to a particular agent helps in the identification, e.g., *Streptococcus pyogenes* is sensitive to bacitracin and *Streptococcus pneumoniae* to optochin. The sensitivity to the antibiotic can be determined by disc diffusion test, serial dilution tests, and E-test, as described in detail in Chapter 9.

### Typing of Bacterial Strains

The ability to discriminate between similar strains of bacteria may be important in tracing sources or modes of spread of infection in a community. Typing methods are widely used for epidemiological studies. These include (a) phenotypic techniques and (b) genotypic techniques.

## ► Phenotypic techniques

Phenotyping techniques depend on various observable properties of bacteria, which are discussed as follows:

- **Biotyping:** It relies on a set of biochemical reactions to distinguish different strains within a given species. Antimicrobial susceptibility testing is an example of this type.
- **Serotyping:** Different strains of organisms of the same species can be differentiated based on the difference in the expression of antigenic determinants on the cell surface.
- **Bacteriocin typing:** This is used in case of bacterial species for which a number of lytic bacteriophages have been identified.
- **Phage typing:** This has been the mainstay of strain discrimination and is widely used in epidemiological studies.

## ► Genotypic techniques

Genotypic techniques depend on differences related to the genome of bacteria. Genotypic techniques employed to differentiate strains of bacteria include plasmid profile analysis and restriction endonuclease analysis of chromosomal DNA.

## Rapid Identification Methods

Automated methods are now available, which take only hours for characterization of isolates. These include detection of specific enzymes, toxins, antigens, or metabolic end products. Obligate anaerobes can be identified by gas liquid chromatography of short-chain fatty acids produced by them.

Latex particle agglutination, coagglutination, direct fluorescent antibody test, and dot enzyme-linked immunosorbent assay (ELISA) are the most frequently used techniques in the clinical laboratory for rapid detection of microbial antigens directly in clinical specimens. Antibody to a specific antigen is bound to latex particles or to a heat-killed and treated protein A-rich strain of *S. aureus* to produce agglutination.

## Molecular Methods

Molecular methods, such as nucleic acid probes, polymerase chain reaction (PCR), and other amplification procedures are also used increasingly nowadays for identification of microorganisms. Genetic probes are based on the detection of unique nucleotide sequences with the DNA or RNA of a microorganism. Hybridization of the sequence with a complementary sequence of DNA or RNA follows cleavage of the double-stranded DNA of the microorganism in the specimen. PCR has major applications in the detection of infections due to microorganisms that are difficult to culture (e.g., the human immunodeficiency virus) or that have not as yet been successfully cultured (e.g., the Whipple's disease bacillus).

## Bacterial Taxonomy

Bacterial taxonomy comprises: (a) bacterial classification of organism and (b) nomenclature or naming of the microbial isolates.

## Bacterial Classification

Bacterial classification may be defined as the arrangement of organisms into taxonomic groups (*taxa*) on the basis of their phenotypic (observable) and genotypic (genetic) similarities and differences. It allows proper and systematic grouping of microorganisms. Organisms are classified into three main kingdoms: Animals, Plants, and Protista. The Protista contains unicellular microorganisms including eukaryotes and prokaryotes. Although no universally accepted bacterial classification system is available, three main approaches are usually followed. These include (a) phylogenetic, (b) Adansonian, and (c) genetic classifications, which are discussed below:

### ► Phylogenetic classification

The phylogenetic classification is a type of hierarchical classification that represents a branching tree-like arrangement, one characteristic being employed for divisions at each branch or level. It is called phylogenetic classification, because it denotes an evolutionary arrangement of species.

This classification groups together the types that are related on evolutionary basis where several groups are used, such as *Divisions, Classes, Orders, Families, Tribes, Genera, and Species*. Some characters of special importance, such as Gram staining properties, lactose fermentation, spore formation, etc., are used to differentiate major groups, whereas less important properties, such as nutritional requirements for growth of bacteria, production of certain enzymes by bacteria, etc., are employed to distinguish minor groups, such as the genera and species.

As per the classification, the full taxonomical position of a bacterium (say, *E. coli*) can be described as follows:

<b>Division:</b>	Protophyta
<b>Class:</b>	Schizomycetes
<b>Order:</b>	Eubacteriales
<b>Family:</b>	Enterobacteriaceae
<b>Tribe:</b>	Escherichiae
<b>Genus:</b>	<i>Escherichia</i>
<b>Species:</b>	<i>coli</i>

*Bergey's Manual of Systematic Bacteriology* is an authoritative published compilation that describes a phylogenetic classification of bacteria. The manual is a useful compilation of names and descriptions of bacteria and is the most standard reference book accepted worldwide. The book is extremely useful for identification of newly isolated bacterial types. A minimum number of important characters, such as morphology of the bacteria, staining properties, cultural characteristics, biochemical reactions, antigenic structure, and guanine to cytosine ratio of DNA, etc., are used for identification and classification of bacteria.

### ► Adansonian classification

The Adansonian classification makes no phylogenetic assumption, but considers all the characteristics expressed at the time of

the study. Hence it is called a phonetic system. The Adansonian classification was first proposed by Michael Adanson in the eighteenth century. It avoids the use of weighted characteristics. This classification gives equal weight to all measurable features and groups of bacteria on the basis of similarities of several characteristics.

Recently, availability of computer facilities has expanded the scope of phonetic classification by permitting comparison of very large number of properties of several organisms at the same time. The computer analysis of large number of characteristics of a bacterium facilitates the identification of several broad subgroups of bacterial strains that are further subdivided into species. This type of classification, based on the properties of large number of properties, is known as numerical taxonomy.

### ► Genetic classification

The genetic or molecular classification is based on homology of the DNA base sequences of the microorganisms. DNA relatedness of the microorganisms is tested first by extracting DNA from the organism to be studied, and then studying the nucleotide sequence of DNA by DNA hybridization or recombination methods. The degree of hybridization can be assessed by many methods, such as by using labeled DNA preparations.

The study of messenger RNA (mRNA) also provides useful information on genetic relatedness among bacteria. The analysis of ribosomal RNA (rRNA) has proved to be of immense value. Study of the nucleotide sequence of 16S ribosomal RNA from different biologic sources has shown evolutionary relationships among widely divergent organisms and has contributed to the understanding of new groups of bacteria, such as the archaeobacteria. Genetic classification is now increasingly used for study of viruses.

### ► Intraspecies classification

Intraspecies classification makes an attempt to subclassify species of a bacteria based on biochemical properties (biotypes), antigenic properties (serotypes), susceptibility to bacteriophage (phage types), and production of bacteriocins (colicin types). Recently, molecular methods have increasingly been used for intraspecies classification of microorganisms, especially viruses.

## Key Points

Molecular methods of intraspecies classification are broadly of two types—phenotypic and genotypic. Phenotypic methods are based primarily on the study of expressed characteristics by microorganisms and are carried out by performing electrophoretic typing of bacterial proteins and immunoblottings. Genotypic methods include direct analysis of genes and chromosomal and extrachromosomal DNA. These genotypic methods include plasmid profile analysis, restriction endonuclease analysis of chromosomal DNA with Southern blotting, PCR, and nucleotide sequence analysis.

## Nomenclature of Microorganisms

Nomenclature refers to the naming of microorganisms. The nomenclature of microorganisms is governed by the International Committee on Systematic Bacteriology and published as *Approved List of Bacterial Names* in the *International Journal of Systematic Bacteriology*. This confers and maintains uniformity for use of names of microorganisms accepted internationally. Similarly, the nomenclature and classification of viruses are governed by the International Committee on Taxonomy of Viruses. Two kinds of names are usually given to bacteria—common name and scientific name:

- (a) The **common or casual name** for a microorganism varies from country to country and is usually known in the local language. For example tubercle bacillus, typhoid bacillus, gonococcus are common names for communication at the local level.
- (b) The **scientific name** is the international name that is accepted throughout the world. By accepted taxonomic conventions, the order names end in *ales* (e.g., the order Eubacteriales), family names end in *aceae* (e.g., the family Enterobacteriaceae), and the tribe names end in *eae* (e.g., the tribe Proteae). The order, family, and tribe names begin with capital letters. The genus name also begins with capital letter, but species name (e.g., *coli*) begins with running letter and not capital letter. Both the genus (e.g., *Escherichia*) and species names are either italicized or underlined when written in the text. The scientific name of the bacterium when written for the first time, is written in full (e.g., *Escherichia coli*), but later mentioned in an abbreviated form (e.g., *Escherichia coli*). When bacteria are referred to as a group, their names are neither capitalized nor italicized or underlined (e.g., streptococci).

# Bacterial Genetics

## Introduction

Genetics is the study of heredity and variation to understand the cause of resemblance and differences between parents and their progeny. The term *genetics* was coined by William Bateson, a British biologist, in 1906.

The unit of heredity is the *gene*, a segment of deoxyribonucleic acid (DNA) that carries in its nucleotide sequence information for a specific biochemical or physiologic property. All hereditary properties are encoded in DNA. Hence, the chromosomal DNA plays an important role in the maintenance of character from generation to generation. Genes carry the information to code for all the necessary components and the actions of life. The genes at each cell division are replicated and a copy is transmitted to each daughter cell.

Although heritability and variations in bacteria have been observed from the early days of bacteriology, it was not known then that bacteria too obey the laws of genetics. It was not until the 1950s that DNA was recognized as the building material of genes.

Bacteria unlike eukaryotic cells (such as human cells) are haploid (1n), which means they have a single copy of each gene. In contrast, eukaryotic cells are diploid (2n); in other words, they have a pair of each chromosome and therefore two copies of each gene. The genotype of an organism is the specific set of genes it possesses.

## Chromosomal Substances

### Structure of DNA

The DNA is the key basic component of gene, which carries the genetic information that is transcribed onto ribonucleic acid and then translated as the particular polypeptide. The basic structure of DNA molecule was first described by Watson and Crick for which they were honored with the Nobel Prize in Medicine. The DNA molecule is composed of two strands of complementary nucleotides wound together in the form of a double helix. The double helix has a diameter of 2 nm. Each full turn of the double helix contains 10 nucleotide pairs and is 3.4 nm in length.

#### ► DNA strand

Each DNA strand has a backbone of deoxyribose (sugar) and phosphate group residues arranged alternately. It has a sugar-phosphate backbone substituted with purine and pyrimidine

bases. It contains four nitrogenous bases, two purines (adenine and guanine), and two pyrimidines (thymine and cytosine).

The two complementary strands are held together by hydrogen bonds between the nitrogenous bases on the opposite strands. The hydrogen bonding follows a specific binding manner in which hydrogen bonds are formed only between guanine and cytosine and between adenine and thymine. Guanine and cytosine form a complementary base pair and adenine and thymine form another base pair.

A molecule of DNA therefore contains as many units of adenine as thymine and of guanine as cytosine. For example, when the arrangement of bases along one strand is AGCTAG, the arrangement on the other strand will be TCGATC. The ratio of adenine and thymine to guanine and cytosine is constant for each species, but varies widely from one bacterial species to another.

During replication, the DNA molecule replicates, first by unwinding at one end to form a fork and then by separation of strands at the other end. Each strand then acts as a template for the synthesis of a complementary strand with which it then forms a double helix.

#### ► Gene

It is a segment of DNA that carries *codons* specifying for a particular polypeptide. A DNA molecule consists of a large number of genes, each of which contains hundreds of thousands of nucleotides. The DNA of a bacterial chromosome is usually arranged in a circular form and when straightened, it measures around 1000  $\mu$ . The length of DNA is usually expressed as kilobases (1 kbp = 1000 base pairs, or bp). Bacterial DNA measures usually 4000 kbp and the human genome about 3 million kbp.

### Key Points

The DNA of *Escherichia coli* is most extensively studied. Typically, it consists of a single circular DNA molecule consisting of approximately  $5 \times 10^6$  bp. It has a molecular weight of  $2 \times 10^9$ . This amount of genetic information in the bacteria can code for about 2000 proteins with an average molecular weight of 50,000 kDa.

### Structure of RNA

Basically, the structure of RNA is similar to that of DNA except for two major differences:

- (a) In DNA, the sugar is D-2-deoxyribose; in RNA, the sugar is D-ribose.

- (b) The RNA contains the nitrogenous base uracil instead of thymine that is present in DNA.

On the basis of structure and function, the RNA can be differentiated into three types:

- (a) Messenger RNA (mRNA),
- (b) Ribosomal RNA (rRNA), and
- (c) Transfer RNA (tRNA).

The RNA molecules range in size from the small tRNAs (which contain fewer than 100 bases) to mRNAs (which may carry genetic messages extending to several thousand bases). Bacterial ribosomes contain three kinds of rRNA with respective sizes of 120, 1540, and 2900 bases and a number of proteins. Corresponding rRNA molecules in eukaryotic ribosomes are somewhat larger.

A few RNA molecules have been shown to function as enzymes (ribozymes). For example, the 23S RNA in the 50S ribosomal subunit catalyzes the formation of the peptide bond during protein synthesis. Some small RNA molecules (sRNA) function as regulators either (a) by binding near the 5' end of an mRNA, preventing ribosomes from translating that message, or (b) by base pairing directly with a strand of DNA near the promoter, preventing transcription.

### Key Points

The most common function of RNA is communication of DNA gene sequences in the form of mRNA to ribosomes. For the synthesis of mRNA, DNA acts as a template; hence adenine, guanine, cytosine, and uracil in mRNA become complementary to the thymine, cytosine, guanine, and adenine, respectively, in DNA. The ribosomes, which contain rRNA and proteins, translate this message into the primary structure of proteins via aminoacyl-tRNAs.

## Mutations

Mutation is a random, undirected, and heritable variation seen in DNA of the cell. This is caused by a change in base sequence of DNA due to addition, deletion, or substitution of one or more bases in the nucleotide sequence of DNA. It can involve any of the genes present in the bacterial chromosome. Mutation results in insertion of a different amino acid into a protein, resulting in the appearance of an altered phenotype.

### Types of Mutations

Mutations are a natural event occurring in dividing cells. The frequency of mutations ranges from  $10^{-2}$  to  $10^{-10}$  per bacterium per division. These occur spontaneously or are enhanced by different mutagens. Mutations are of three types: (a) base substitution, (b) frame-shift mutation, and (c) mutations due to transposons or insertion sequences.

#### ► Mutation due to base substitution

This type of mutation occurs when one base in the nucleotide sequence is inserted in place of another. This occurs during

replication of DNA either due to an error in the function of DNA polymerase or due to a mutagen that alters the hydrogen bonding of the base being used as a template in such a manner that the wrong base is inserted. The base substitution mutation may be of two types: *missense mutation* and *nonsense mutation*.

**A. Missense mutation:** It is one in which the base substitution results in a codon that specifies a different amino acid to be inserted.

**B. Nonsense mutation:** It is another type of mutation in which the base substitution produces a terminal codon that stops synthesis of protein prematurely. Entire protein function is destroyed during the process of nonsense mutation.

#### ► Frame-shift mutation

It is the second type of mutation. This occurs when one or more base pairs are added or deleted in the DNA. This, therefore, leads to shifting of the reading frame of the ribosome that results in incorporation of the wrong amino acids downstream from the mutation. Result of the frame-shift mutation ends in production of an inactive protein.

#### ► Mutation due to transposons or insertion sequence

This is the third type of mutation that occurs when transposons or insertion sequences are integrated into the DNA. These newly inserted pieces of DNA cause profound changes in the gene into which they are inserted and also causes changes in the adjacent genes.

## Causative Agents of Mutation

Mutation can be caused by (a) viruses, (b) radiation, or (c) chemicals.

#### ► Viruses

Bacterial viruses (*mutator bacteriophage*) are an example of viruses that cause a high frequency of mutation by inserting their DNA into the bacterial chromosome. Mutations can occur in various genes as viral DNA can insert bacterial chromosome at many different sites. The mutations caused by these viruses may be either frame-shift mutations or deletions.

#### ► Radiations

X-rays and ultraviolet light are the examples of radiation that can cause mutation in chromosomal DNA.

- **X-rays:** X-rays damage DNA in many ways. They cause damage by producing free radicals that can attack the bases or alter them in the strand, thereby changing their hydrogen bonding. They also damage DNA by breaking the covalent bonds that hold the ribose phosphate together.
- **Ultraviolet light:** Ultraviolet radiation causes damage in DNA by cross-linking of the adjacent pyrimidine bases to form dimers. For example, the cross-linking of adjacent thymine to form thymine dimers results in the inability of DNA to replicate properly.



## ► Chemicals

Various chemicals, such as nitrous acid, alkylating agents, benzpyrene, and base analogs, such as 5-bromouracil cause mutation in several different ways:

- **Benzpyrene:** This is commonly present in tobacco smoke that binds to existing DNA bases and causes frame-shift mutations. The benzpyrene, which is a carcinogen as well as a mutagen, intercalates between the adjacent bases, thereby distorting and offsetting the nucleotide sequence in the DNA.
- **Nitrous acid and alkylating agents:** They act by altering the existing base in the DNA. This results in formation of a hydrogen bond with a wrong base. For example, adenine does not form bond with thymine but makes wrong pair with cytosine.
- **Base analogs:** Base analogs, such as 5-bromouracil, have less hydrogen bonding capacity than thymine, so they bind to guanine with better frequency. This results in a mutation due to a transition from AT base pair to a GC base pair. Iododeoxyuridine, an antiviral drug, also acts as a base-pair analog.

## Effects of Mutations

Mutations in the bacteria cause a lot of changes in their various properties. Mutation alter drug susceptibility, antigenic structure, and virulence of mutant bacteria. It also alter susceptibility of bacteria to bacteriophages, alter their colony morphology and pigment productions, and affect their ability to produce capsule or flagella. Development of drug resistance due to mutations in bacteria is a major health concern.

## Conditional Lethal Mutation

Lethal mutations occur when some mutations involve vital functions, resulting in production of nonviable mutants. On the other hand, a conditional lethal mutation is a form of lethal mutation, in which mutation is expressed only under certain conditions, resulting in production of viable mutants. This is of medical importance, because it is made use for preparation of vaccine strains. Temperature-sensitive strains are the most common example of conditional lethal mutations.

The temperature-sensitive organisms have the unique property of replicating at a low permissive temperature, such as 32°C but cannot grow at a higher restrictive temperature, such as 37°C. This is due to a mutation that causes changes in an amino acid in an essential protein, allowing these organisms to function at 32°C but not at 37°C. Temperature-sensitive influenza virus strain used in experimental vaccine is an example of conditional lethal mutations. This influenza vaccine contains a virus that can grow at 32°C and infect nose and can replicate and induce immunity. But the virus cannot grow at 37°C, hence cannot infect the lungs and does not cause pneumonia.

## Extrachromosomal DNA Substances

### Plasmids

Plasmids are extrachromosomal DNA substances. They are replicons that are maintained as discrete, extrachromosomal genetic elements in bacteria. They are usually much smaller than the bacterial chromosome, varying from less than 5 to more than several 100 kbp. However, plasmids as large, as 2 million base pairs can occur in some bacteria. Plasmids are circular and double-stranded DNA molecules that encode traits that are not essential for bacterial viability. They are capable of replicating independently of the bacterial chromosomes. The plasmids can also be present as integrated with bacterial chromosomes, and plasmids integrated with host chromosome are known as *episomes*. Plasmids are present in both Gram-positive and Gram-negative bacteria.

### ► Types of plasmids

Plasmids depending on their transmissibility and nature of the factor can be of the following types:

#### Transmissibility of plasmids

Plasmids, depending on transmissibility are of two types: (a) transmissible plasmids and (b) nontransmissible plasmids.

1. **Transmissible plasmids:** They can be transferred from cell to cell by a process of genetic transfer known as conjugation. They are large (mol. wt. 40–100 million) plasmids. They contain more than a dozen genes responsible for synthesis of the sex pilus and for the synthesis of enzymes required for their transfer. Usually, one to three copies of the plasmid are present in a cell.
2. **Nontransmissible plasmids:** These cannot be transferred from cell to cell, because they do not contain the transfer genes. They are small (mol. wt. 3–20 million), usually non-conjugative, and have high copy numbers (typically 10–60 per chromosome). They depend on their bacterial host to provide some functions required for replication and are distributed randomly between daughter cells at division.

#### Nature of factors

Depending on the nature of factors, plasmids are of the following types: (a) the F factor, (b) the R factor, and (c) the Col factor.

1. **The F factor:** The F plasmid, also called F factor, is a transfer factor that contains the genetic information, essential for controlling mating process of the bacteria during conjugation.

The F plasmid of *Escherichia coli* is the prototype for fertility plasmids in Gram-negative bacteria. Strains of *E. coli* with an extrachromosomal F plasmid are called F+ and function as donors, whereas strains that lack the F plasmid are F– and behave as recipients. The conjugative functions of the F plasmid are determined by a cluster of at least 25 transfer (*tra*) genes. These genes determine (a) expression

of pili, (b) synthesis and transfer of DNA during mating, (c) interference with the ability of F<sup>+</sup> bacteria to serve as recipients, and (d) other functions.

The F plasmid in *E. coli* can occur as an extrachromosomal genetic element or be integrated into the bacterial chromosome. Both the F plasmid and the bacterial chromosome are circular DNA molecules. Hence, reciprocal recombination between them produces a larger DNA circle consisting of F-plasmid DNA inserted linearly into the chromosome.

2. **The R factor:** Resistance factors, also called R factors, are extrachromosomal plasmids. They are circular with double-stranded DNA. R factors occur in two sizes: large plasmids (mol. wt. 60 million) and small plasmids (mol. wt. 10 million). The large plasmids are conjugative “R” factors, which contain extra DNA to code for the conjugation process. The small plasmids contain only the “r” genes and are not conjugative. R factor consists of two components: the resistance transfer factor (RTF) and resistant determinant (r). The RTF is responsible for conjugational transfer, while each r determinant carries resistance for one of the several antibiotics.

## Key Points

### Functions of R factor:

- The R factors are responsible for spread of multiple-drug resistance among bacteria. They carry the genes for a variety of enzymes that can destroy antibiotics and modify membrane transport system. The R factor may carry one antibiotic resistance gene or may carry two or more of these genes. The R factor carrying more than two genes has many clinical implications:
    - First and foremost, a bacterium carrying such genes will show resistance to more than one type of antibiotics, such as penicillins and aminoglycosides.
    - The second importance is that the use of an antibiotic that selects an organism for a bacterium resistant to one antibiotic (such as penicillin) will select for a bacterium resistant to other antibiotics (such as tetracyclines, aminoglycosides, chloramphenicol, erythromycin, etc.).
  - They may also carry genes for resistance to metal ions. For example, the genes code for an enzymes that reduce mercuric ions to elementary mercury, thereby making the bacteria resistant to action of mercuric ions.
  - They also carry resistance to certain bacteriophages by coding for the enzymes, e.g., restriction endonucleases that degrade the DNA of the infecting bacteriophages.
3. **Colicinogenic (Col) factor:** Col factor is a plasmid that resembles the F factor in promoting conjugation, leading to self-transfer and also at times transfer of segments of chromosomes.
    - The Col factor encodes for production of colicins, which are antibiotics-like substances that are specifically and selectively lethal to other enteric bacteria.
    - They also encode for production of diphthericin and pyocyanin produced by *Corynebacterium diphtheriae* and *Pseudomonas pyocyanea*, respectively, which are substances similar to colicins.

## Box 7-1 Plasmid-determined properties

Plasmids carry genes for the following:

1. Resistance to antibiotics that is mediated by a variety of enzymes.
2. Resistance to ultraviolet light that is mediated by DNA repair enzymes.
3. Resistance to heavy metals such as mercury and silver that is mediated by enzyme reductase.
4. Pili that mediate the adherence of bacteria to epithelial cells. Examples include K88, K99 found in uropathogenic *E. coli*.
5. Exotoxins including many enterotoxins. Representative toxins encoded by plasmids include heat-labile and heat-stable enterotoxins of *E. coli*, exfoliative toxin of *Staphylococcus aureus*, hemolysins of *Clostridium perfringens*, and tetanus toxin of *Clostridium tetani*.
6. Bacteriocins produced by certain Gram-negative bacteria are lethal for other bacteria. Examples include pyocin produced by *P. pyocyanea* and diphthericin produced by *C. diphtheriae*.
7. A variety of enzymes such as urease of *Helicobacter pylori* and proteases of *Pseudomonas* spp. have degradative properties. The degradative enzymes produced by *Pseudomonas* spp. are capable of cleaning of oil spills and toxic chemical wastes in the environment.

## ► Functions of plasmids

Many plasmids control medically important properties of pathogenic bacteria. These include (a) resistance to one or several antibiotics, (b) production of toxins, and (c) synthesis of cell surface structures required for adherence or colonization. Plasmid-determined properties are summarized in Box 7-1. Some plasmids are cryptic and have no recognizable effects on the bacterial cells that harbor them. Comparing plasmid profiles is a useful method for assessing possible relatedness of individual clinical isolates of a particular bacterial species for epidemiological studies.

## Transfer of DNA Within Bacterial Cells

Transfer of DNA within the bacterial cells can occur by (a) transposons (b) integrative conjugating elements, and (c) programmed rearrangement.

## Transposons

Transposons are a type of mobile DNA of 2000–20,000 bp. They can transfer DNA from one site of the bacterial chromosome to another site or to a plasmid. The idea of transposons or jumping genes was first given by Barbara McClintock, a geneticist working in the field of maize genetics.

The mode of genetic transfer by transposon is called **transposition**. The transposition differs from recombination in that a segment of DNA can be transferred from one to another molecule that has no genetic homology with either the transposable element or the donor DNA.

Transposons do not occur independently but have the characteristic of jumping from one part of a chromosome to another or to a plasmid. They can also jump from one plasmid to another or back to the chromosome, hence, are called as **jumping genes**. Transposition in prokaryotes usually involves two steps—self-replication and recombination. They jump from one part to

another by synthesizing a copy of their DNA and inserting the copy at another site in the bacterial chromosome or the plasmid. Transposons, unlike plasmids, are not self-replicating and depend on chromosomal or plasmid DNA for replication. Transposons do not require homology with the recipient site for its transfer. Transposons typically consist of four domains:

- The first domain is a short DNA sequence of inserted repeats that are present at the end. This domain mediates the integration of the transposons into the recipient DNA.
- The second domain is the gene for the enzyme transposases. These enzymes mediate the excision and integration process.
- The third domain is the gene for the repressor, which regulates the synthesis of both transposase and the gene products of the fourth domain.
- The fourth domain is the gene for the expression of enzymes.

Plasmid can contain several transposons carrying drug-resistance genes. The transposons code for drug-resistance enzymes, toxins, or a variety of metabolic enzymes. These transposons can either cause mutations in the gene into which they insert or alter the expression of nearby genes.

**Insertion sequences:** The simplest form of transposons is the insertion sequences. These are a type of transposons that have a few bases varying from 800 to 1500 bp. They are found as multiple copies at the end of larger transposon units. These cause mutation by moving from one side to another in DNA sequence and are believed to control various cellular responses.

## Integrative Conjugative Elements

Integrative conjugative elements (ICEs) are ways of horizontal gene transfer and self-transmissible mobile genetic elements. The elements exchange by conjugation, but need to integrate into chromosome to propagate. They cannot replicate autonomously. ICEs integrate into and replicate along with the host cell chromosome, whereas plasmids exist as extra-chromosomal (usually circular) autonomously replicating DNA molecules.

## Programed Rearrangements

The transfer of DNA within bacteria can also occur by programed rearrangement. In this programed rearrangement, there is a movement of a gene from a silent site where the gene is not expressed to an active site where transcription and translation occur.

Many silent genes are present in the DNA that encode variants of the antigens. Presentation of the new gene into the active site occurs in a sequential and repeated manner, which then manifests in antigenic variations in the bacteria and parasites. This mechanism is responsible for antigenic variations seen in *Neisseria gonorrhoeae*, *Borrelia recurrentis*, and *Trypanosoma brucei*.

## Transfer of DNA Between Bacterial Cells

The genetic information can be transferred from one bacterium to another. There are three general methods for genetic exchange in bacteria: (a) transformation, (b) transduction, and (c) conjugation.

## Transformation

**Transformation** is a process of the transfer of DNA itself from one bacterium to another. This may occur either in nature or in a laboratory. In nature, DNA is released from a bacterium by lysis, which may be taken up by recipient bacterium that must be competent. This natural process of transfer of genetic material appears to play no role in disease. In laboratory conditions, DNA may be extracted from one type of bacterium and introduced into genetically different bacteria. The cell walls of bacteria *in vitro* are made more permeable for DNA uptake by using substances, such as calcium chloride.

Griffith (1922) in his classical experiment on mice demonstrated that neither of the mice died when injected separately with a live, noncapsulated *Pneumococcus* (nonvirulent) and heat-killed, capsulated *Pneumococcus* (nonvirulent), but the mice died when they were injected with a mixture of both these strains. From the dead mice, he could isolate live, capsulated pneumococci, which were virulent. He demonstrated that some factor in heat-killed, capsulated pneumococci had transferred the material for capsule synthesis in the noncapsulated strains of the bacteria, making them virulent (Fig. 7-1).

McLeod and McCarthy in 1944 demonstrated that DNA extracted from encapsulated, smooth pneumococci could transform nonencapsulated, rough pneumococci into capsulated, smooth organisms. They demonstrated the transforming principle of DNA. The experimental use of transformation was the first experiment to reveal important information about DNA and was the first example of genetic exchange in bacteria.

Another bacterium where transformation is observed is *Haemophilus influenzae*.

### Key Points

When purified DNA is injected into the nucleus of a bacterial cell, the process is called *transfection*. Transfection is frequently used in genetic engineering studies.

## Transduction

The transfer of a portion of DNA from one bacterium to another mediated by a bacteriophage is known as **transduction**. During replication of virus within the cell, a piece of bacterial DNA is incorporated into the bacteriophage and is carried into the recipient bacterium at the time of infection. The phage DNA within the recipient bacterial cell integrates into the cell DNA during a process called **lysogenic conversion**. The process of lysogenic conversion confers a new property to the bacterial cell; for example, by lysogenic conversion non-pathogenic bacteria can become pathogenic. Bacteriophages encode diphtheria toxin, botulinum toxin, cholera toxin, and erythrogenic toxin and can be transferred from one bacterium to another by transduction (Fig. 7-2). Transduction is of two types: (a) generalized transduction and (b) specialized transduction.

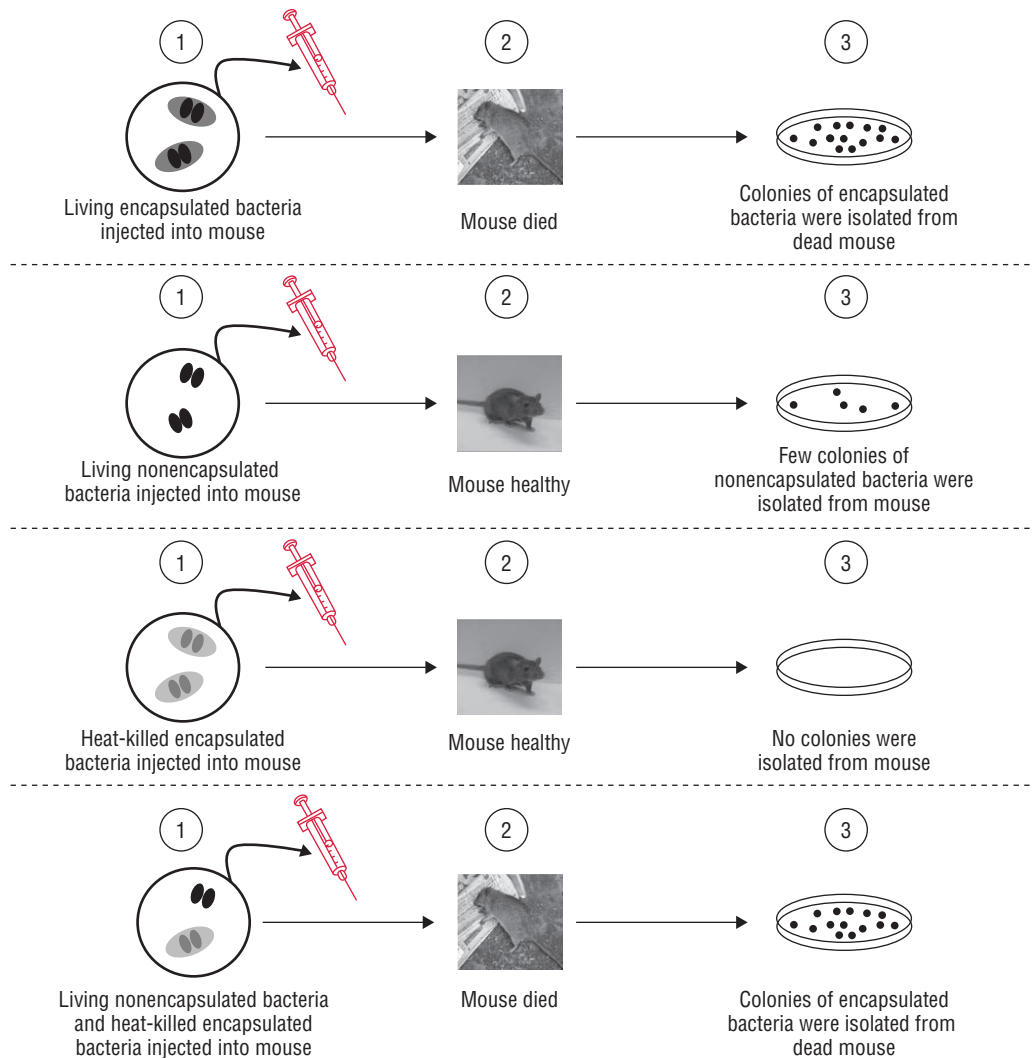

FIG. 7-1. A schematic diagram showing transmission of DNA by transformation.

### ► Generalized transduction

This occurs when a small fraction of the phage virions produced during lytic cycle are aberrant and contain a random fragment of the bacterial genome instead of phage DNA. Each individual transducing phage carries a different set of closely linked genes, representing a small segment of the bacterial genome. Transduction mediated by populations of such phages is called **generalized transduction**. Each part of the bacterial genome has approximately the same probability of being transferred from donor to recipient bacteria.

Generalized transduction involves any segment of the donor DNA at random. This occurs because the cell DNA is fragmented after such infection and pieces of same DNA, the same size as viral DNA, are incorporated into the bacterial DNA. This occurs at a frequency of about 1 in every 1000 viruses. Generalized transduction may be complete or abortive:

- **Complete transduction** is characterized by production of stable recombinants that inherit donor genes and retain the ability to express them.

- **Abortive transduction** refers to the transient expression of one or more donor genes without formation of recombinant progeny. The donor DNA fragment does not replicate in abortive transduction, and only one bacterium contains the donor DNA fragment among the progeny of the original transductant. The donor gene products become progressively diluted in all other progeny after each generation of bacterial growth until the donor phenotype can no longer be expressed.

On selective medium, abortive transductants produce minute colonies that can be distinguished easily from colonies of stable transductants. The frequency of abortive transduction is typically one to two times more than the frequency of generalized transduction. This indicates that most cells infected by generalized transducing phages do not produce recombinant progeny.

### ► Specialized transduction

Specialized transduction results from lysogenization of the recipient bacterium by the specialized transducing phage and expression of the donor genes. Specialized transducing phages

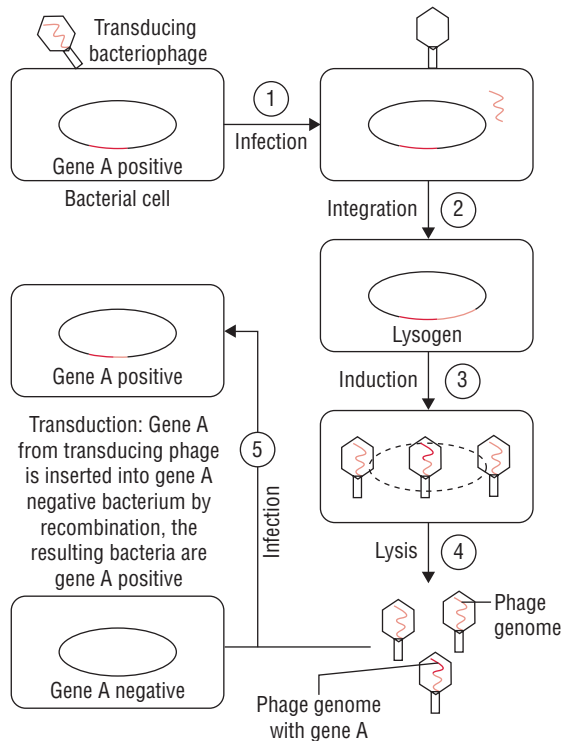

**FIG. 7-2.** A schematic diagram showing transmission of genetic material by bacteriophage-mediated transduction.

are formed only when lysogenic donor bacteria enter the lytic cycle and release phage progeny.

The specialized transducing phages are rare recombinants that lack part of the normal phage genome. They contain part of the bacterial chromosome present adjacent to the site of prophage attachment. Many specialized transducing phages are defective. They cannot complete the lytic cycle of phage growth in infected cells unless helper phages are present to provide missing phage functions.

Specialized transduction differs from generalized transduction in many ways. The former is mediated only by specific temperate phages and only a few specific donor genes can be transferred to recipient bacteria.

## Key Points

Transduction is not only confined to transfer of chromosomal DNA but also to plasmids and episomes. Transformation involving transfer of plasmids from one bacterium to another by transduction is responsible for penicillin resistance in staphylococci. Transduction appears to be the most widespread mechanism of gene transfer among bacteria. This method also provides an excellent tool for the genetic mapping of the bacteria. It can occur in many bacteria for which bacteriophages are known. It may occasionally occur in eukaryotic cells.

## Conjugation

Conjugation is a process of transfer of DNA from the donor bacterium to the recipient bacterium during the mating of two

bacterial cells. In conjugation, direct contact between the donor and recipient bacteria leads to formation of a cytoplasmic bridge between them and transfer of part or all of the donor genome to the recipient (Fig. 7-3). Conjugation takes place between two closely related species and occurs mostly in Gram-negative bacteria. Conjugation also occurs in Gram-positive bacteria.

Donor ability of bacteria is determined by specific conjugative plasmids called fertility ( $F^+$ ) plasmids or sex plasmids. The  $F$  plasmid controls the mating process of bacteria. Pilus is the most important protein that forms the sex pilus or conjugation tube. The sex pilus produces a bridge between conjugating cells in Gram-negative bacteria. Mating occurs between the donor male bacterium carrying the  $F$  factor ( $F^+$ ) and the recipient female bacterium that does not contain  $F$  factor ( $F^-$ ). It begins when the pilus of  $F^+$  bacterium attaches to a receptor on the surface of a female ( $F^-$ ) bacterium. The cells are then brought into direct contact by the link in the pilus. This is followed by an enzymatic cleavage of the  $F$  factor DNA in which one strand of bacterial DNA is transferred into the recipient cell through the conjugation bridge. The synthesis of the complementary strand to form a double-stranded  $F$ -factor plasmid in both the donor and recipient cells completes the process of conjugation. The recipient cell becomes  $F^+$  male that is capable of transmitting the plasmid to other  $F^-$  cells.

**High-frequency recombination (Hfr):** Long length of DNA can be transferred by process of conjugation. Hfr strain is a type of  $F^+$  cells that have an  $F$  plasmid integrated into the bacterial DNA. Hence they acquire the capability of transferring the

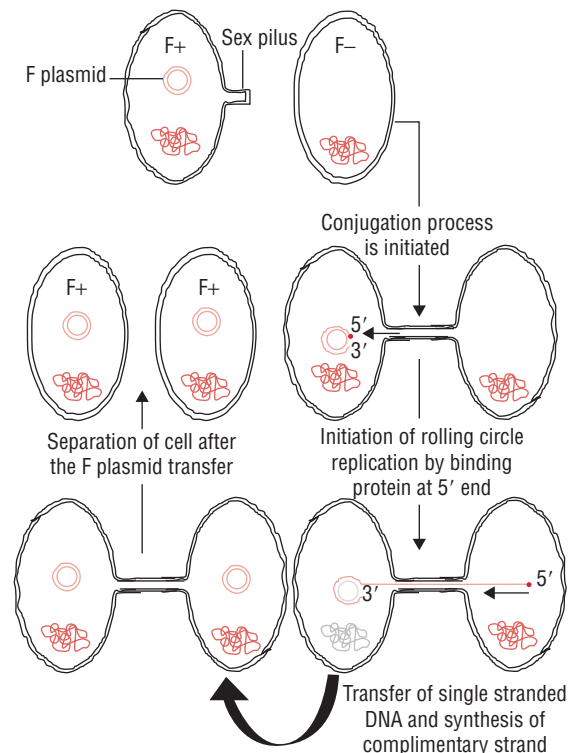

**FIG. 7-3.** A schematic diagram showing transmission of genetic material by conjugation.

TABLE 7-1

## Comparison of transformation, transduction, and conjugation

Methods of transfer	Mechanism	Nature of DNA transferred
<b>Transformation</b>	Recipient cell uptake of free DNA released into the environment	Any gene
<b>Transduction</b>	Transfer of DNA from one bacterium to another by bacteriophage	Any gene in generalized transduction; only selected genes in specialized transduction
<b>Conjugation</b>	Transfer of DNA from one living bacterium to another through the sex pilus	Chromosomal or plasmid DNA

chromosome to another cell. A whole chromosome can be transferred if it is integrated with F plasmid. In this process, the single strand of DNA that enters the recipient F<sup>-</sup> cell contains a part of the F factor at one end, followed by the bacterial chromosome, and then by the remainder of the F factor. The bacterial genes adjacent to the leading piece of F factor are the most frequently transferred. The newly acquired DNA recombines with the recipient DNA and becomes an integral component of genetic material. The complete transfer of the bacterial DNA is usually completed in approximately 100 minutes.

In matings between F<sup>+</sup> and F<sup>-</sup> bacteria, only the F plasmid is transferred with high efficiency to recipients. Chromosomal genes are transferred with very low efficiency, which is mediated by the spontaneous Hfr mutants in F<sup>+</sup> populations. In matings between Hfr and F<sup>-</sup> strains, the segment of the F plasmid containing the *tra* region is transferred last, after the entire bacterial chromosome has been transferred. Most recombinants produced after matings between Hfr and F<sup>-</sup> cells fail to inherit the entire set of F-plasmid genes and are phenotypically F<sup>-</sup>. In matings between F<sup>+</sup> and F<sup>-</sup> strains, the F plasmid

spreads rapidly throughout the bacterial population and most recombinants are F<sup>+</sup>.

Conjugation also occurs in Gram-positive bacteria. Gram-positive donor bacteria produce adhesions that cause them to aggregate with recipient cells, but sex pili are not involved. In some *Streptococcus* spp., recipient bacteria produce extracellular sex pheromones that facilitate conjugation. Table 7-1 shows a comparison of transformation, transduction, and conjugation.

### Key Points

Transfer of plasmids during conjugation is responsible for the spread of multiple drug resistance among bacteria. The plasmid responsible for drug resistance consists of two components, namely, RTF and a *resistance determinant* (*r*) for each of the several drugs. Transferable drug resistance occurs widely among pathogenic as well as commensal bacteria of humans and animals. Plasmid is also responsible for production of colicins, the antibiotic-like substances lethal to other Gram-negative bacteria. The plasmid that encodes for production of colicins is known as col factor and is also transferred by conjugation.

### Recombination

After the DNA is transferred from one donor bacterium to the recipient through transformation, transduction, or conjugation, it combines with the chromosome of the bacterium by a process called **recombination**.

Recombination is of two types: homologous and nonhomologous. Homologous recombination takes place between two pieces of DNA showing extensive homologous regions. This results in pairing up and exchange of pieces by the processes of breakage and reunion. The nonhomologous recombination takes place between two pieces of DNA showing little or no homology.

# Genetic Engineering and Molecular Methods

## Introduction

The deliberate modification of an organism's genetic information by directly changing its nucleic acid genome is called **genetic engineering** and is achieved by a group of methods known as **recombinant DNA technology**.

## DNA: An Amazing Molecule

The structure of deoxyribonucleic acid (DNA) provides a complex code that encodes for synthesis of proteins. The DNA as a molecule exhibits many intriguing features. One useful property of DNA is that it readily *anneals*, meaning that it changes its binding properties in response to heating and cooling. Exposure to temperatures just below boiling (90–95°C) causes DNA to become temporarily *denatured*. When heat breaks open the hydrogen bonds that keep the double helix together, it separates longitudinally into two strands. Each strand displays its nucleotide code so that the DNA in this form can be subjected to tests or replicated. When heating is followed by gradual cooling, two single DNA strands rejoin (*renature*) by hydrogen bonds at complementary sites. Annealing is a necessary feature of the polymerase chain reaction (PCR) and nucleic acid probes described later.

## Genetic Engineering

Genetic engineering is the application of science to social needs. In recent years, engineering based on bacterial genetics has transformed biology. Specified DNA fragments can be isolated and amplified, and their genes can be expressed at high levels. The nucleotide specificity, required for cleavage by restriction enzymes, allows fragments containing genes or parts of genes to be covalently bound to plasmids (*vectors*) that can then be inserted into bacterial hosts.

Bacterial colonies or *clones* carrying specified genes are identified by *hybridization* of DNA or RNA with chemical or radiochemical *probes*. Alternatively, protein products encoded by the genes are recognized either by enzyme activity or by immunologic techniques. Thus, genetic engineering techniques are used to isolate virtually any gene with a biochemically recognizable property.

## Preparation of DNA Fragments with Restriction Enzymes

The genetic diversity of bacteria is reflected in their remarkable range of *restriction enzymes*, which possess remarkable selectivity that allows them to recognize specific regions of DNA for cleavage. DNA sequences recognized by restriction enzymes are predominantly *palindromes* (inverted sequence repetitions). GAATTC is a typical sequence palindrome, recognized by the frequently used restriction enzyme *EcoRI*. The inverted repetition, inherent in the complementarity of the G–C and A–T base pairs, results in the 5' sequence TTC being reflected as AAG in the 3' strand.

Most restriction enzymes recognize 4, 6, or 8 base sequences; however, other restriction enzymes recognize 10, 11, 12, or 15 base sequences. Restriction enzymes that recognize 8 bases produce fragments with a typical size of 64,000 bp and are useful for analysis of large genetic regions. Restriction enzymes that recognize more than 10 bases are useful for construction of a physical map and for molecular typing by pulse-field gel electrophoresis.

## Physical Separation of Differently Sized DNA Fragments

Much of the simplicity underlying genetic engineering techniques lies in the fact that gel electrophoresis permits DNA fragments to be separated on the basis of size. The smaller the fragment, the more rapid the migration. Overall rate of migration and optimal range of size for separation are determined by the chemical nature of the gel and by the degree of its cross-linking. Highly cross-linked gels optimize the separation of small DNA fragments. The dye ethidium bromide forms a brightly fluorescent color as it binds to DNA, and so small amounts of separated DNA fragments can be photographed on gels. Specific DNA fragments can be recognized by probes containing complementary sequences.

Pulsed-field gel electrophoresis allows the separation of DNA fragments containing up to 100,000 bp (100 kilobase pairs, or kbp). Characterization of such large fragments has allowed construction of a physical map for the chromosomes from several bacterial species.

## Enzymes for Dicing, Splicing, and Reversing Nucleic Acids

**Restriction endonucleases:** The polynucleotide strands of DNA can also be clipped crosswise at selected positions by

means of enzymes called restriction endonucleases. These enzymes recognize foreign DNA and are capable of digesting or hydrolyzing DNA bonds. Presence of enzyme in the bacterial cell protects bacteria against the incompatible DNA of bacteriophages or plasmids.

In a laboratory, restriction endonuclease enzymes can be used to cleave DNA at desired sites and are a must for the techniques of recombinant DNA technology. So far, hundreds of restriction endonucleases have been discovered in bacteria. Each type has a known sequence of 4–10 bp as its target, so sites of cutting can be finely controlled. Endonucleases are named by combining the first letter of the bacterial genus, the first two letters of the species, and the endonuclease number. For example, *EcoRI* is the first endonuclease found in *Escherichia coli* and *HindIII* is the third endonuclease discovered in *Haemophilus influenzae* typed.

**Restriction fragment length polymorphisms:** The pieces of DNA produced by restriction endonucleases are termed *restriction fragments*. Because genomes of members of the same species can vary in the cutting pattern by specific endonucleases, it is possible to detect genetic differences by *restriction fragment length polymorphisms* (RFLPs).

Hundreds of cleavage sites that produce RFLPs are distributed throughout genomes. Because RFLPs serve as a type of *genetic marker*, they can help locate specific sites along a DNA strand. The RFLPs are thus useful in preparation of gene maps and DNA profiles, and also in analysis of genetic relationships.

**Ligase:** It is an enzyme necessary to seal the sticky ends together by rejoining the phosphate–sugar bonds cut by endonucleases. Its main application is in final splicing of genes into plasmids and chromosomes.

**Reverse transcriptase:** It is an enzyme, best known for its role in the replication of the AIDS virus and other retroviruses. This enzyme is used by geneticists as a valuable tool for converting RNA into DNA.

**Complementary DNA:** The copies called *complementary DNA*, or *cDNA*, can be made from messenger, transfer, ribosomal, and other forms of RNA. The technique provides a valuable means of synthesizing eukaryotic genes from mRNA transcripts. The advantage is that the synthesized gene will be free of the intervening sequences (*introns*) that can complicate the management of eukaryotic genes in genetic engineering. Complementary DNA can also be used to analyze the nucleotide sequence of RNAs, such as those found in ribosomes and transfer RNAs.

## Methods Used to Size, Synthesize, and Sequence DNA

The relative sizes of nucleic acids are usually known by the number of base pairs or nucleotides they contain. For example, the palindromic sequences recognized by endonucleases are usually 4–10 bp in length. An average gene in *E. coli* is approximately 1300 bp, or 1.3 kilobases (kb), and its entire genome is approximately 4.7 million base pairs (Mb). The Epstein–Barr virus, cause of infectious mononucleosis, has a gene of 172

kb. Humans have approximately 3.5 billion base pairs (Bbp) arrayed along 46 chromosomes.

**Oligonucleotides** are very short pieces of DNA or RNA. They vary in length from 2 to 200 bp, although the most common ones are about 20–30 bp. They can be isolated from cells or prepared tailor-made by a DNA synthesizer that limits the length to about 200 nucleotides.

Hybridization probes are used routinely in the cloning of DNA. The amino acid sequence of a protein is used to deduce the DNA sequence from which a probe may be constructed and employed to detect a bacterial colony containing the cloned gene. cDNA, encoded by mRNA, is used to detect the gene that encodes the mRNA.

## Types of hybridization

Hybridization is of the following types:

- **Northern blot:** Hybridization of DNA to RNA is known as *Northern blot*, which provides quantitative information about RNA synthesis.
- **Southern blot:** Hybridization of DNA to DNA is known as *Southern blot*. This method is useful to detect specific DNA sequences in restriction fragments separated on gels. These blots can be used to detect overlapping restriction fragments.
- **Western blot:** It is a technique used for detection of genes, in which antibodies are used to detect cloned genes by binding to their protein products.

Cloning of these fragments makes it possible to isolate flanking regions of DNA by a technique known as *chromosomal walking*.

## DNA sequencing

DNA sequencing shows gene structure that helps research workers to find out the structure of gene products.

### Key Points

DNA sequencing has many applications as follows:

- Information obtained by DNA sequencing makes it possible to understand or alter the function of genes.
- DNA sequence analysis demonstrates regulatory regions that control gene expression and genetic “hot spots” particularly susceptible to mutation.
- Comparison of DNA sequences shows evolutionary relationships that provide a framework for definite classification of microorganisms including viruses.
- Comparison of DNA sequences facilitates identification of conserved regions, which are useful for development of specific hybridization probes to detect microorganisms including viruses in clinical samples.

Maxam–Gilbert technique and Sanger (dideoxy termination) method are two methods used routinely for DNA sequence determination. Maxam–Gilbert technique depends on the relative chemical liability of different nucleotide bonds, whereas the Sanger method interrupts elongation of DNA sequences by incorporating dideoxynucleotides into the sequences.



**Shotgunning:** The study of biology has been revolutionized by the development of technology that allows sequencing and analysis of entire genomes ranging from viruses to unicellular prokaryotic and eukaryotic microorganisms to humans. This has been facilitated by use of the procedure known as **shotgunning**. In this procedure, the DNA is broken into random smaller fragments to create a random fragment library.

## Nucleic Acid Probes

Nucleic acid probes are segments of DNA and RNA labeled with radioisotopes or enzymes that can hybridize to complementary nucleic acids with high degree of specificity. Hybridization probes have practical value, because they can detect specific nucleotide sequences in unknown samples. The probes carry reporter molecules, such as radioactive labels, which are isotopes that emit radiation, or luminescent labels, which give off visible light. Reactions can be revealed by placing photographic film in contact with the test reaction. Fluorescent probes contain dyes that can be visualized with ultraviolet light. Probes can be used in a broad range of analytic procedures.

Two different nucleic acids can *hybridize* by uniting at their complementary sites. All different combinations are possible: single-stranded DNA can unite with other single-stranded DNA or RNA, and RNA can hybridize with other RNA. This property forms the basis of specially formulated oligonucleotide tracers called **gene probes**.

## Key Points

### Applications of DNA Probes

DNA probes are nonamplified methods; they only detect DNA in specimens but without any amplification of the same (Fig. 8-1). DNA probes have many applications as follows:

- A number of DNA probes have been developed for identification of culture isolates and for various uses in clinical microbiology by (a) direct detection of microbes in clinical specimens and (b) by identification of organisms after isolation of culture (Box 8-1).
- Some regions of human DNA exhibit substantial variability in the distribution of restriction sites. This variability is termed *restriction fragment length polymorphism*. Oligonucleotide probes that hybridize with RFLP DNA fragments can be used to trace DNA from a small sample to its human donor. Thus, the technique is valuable to forensic science.
- Applications of RFLP to medicine include identification of genetic regions that are closely linked to human genes with dysfunctions coupled to genetic disease. This information will be a valuable aid in genetic counseling.

## Polymerase Chain Reaction

In 1983, Kary Mullis developed a new technique that made it possible to synthesize large quantities of a DNA fragment without cloning it. This technique is called polymerase chain

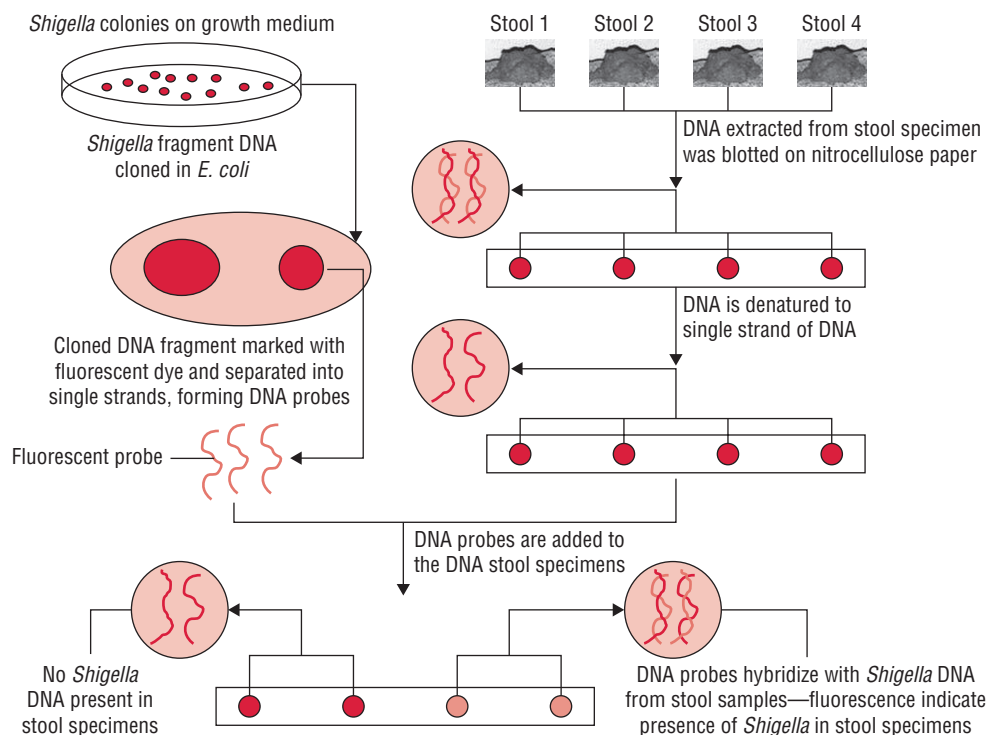

**FIG. 8-1.** A schematic diagram showing the principle of DNA probe.

**Box 8-1 Applications of DNA probes**

1. Direct detection of microbes in clinical specimens (e.g., *Mycobacterium tuberculosis*, *Streptococcus pyogenes*, *Candida albicans*).
2. Diagnosis of uncultivable bacteria (e.g., *Chlamydia*, rickettsia, etc.).
3. Identification of culture isolates.
4. Strain identification for epidemiological typing.
5. Identification of virulence factors of microbial agents.
6. Identification of toxins (e.g., diphtheria toxin).

reaction (PCR) and has great practical importance and impact on biotechnology. By this technique, large quantities of a particular DNA sequence can be prepared.

In PCR, oligonucleotide sequences identical to those flanking the targeted sequence are first synthesized. These synthetic oligonucleotides are usually about 20 nucleotides long and serve as primers for DNA synthesis. Pieces ranging in size from less than 100 bp to several 1000 bp in length can be amplified, and only 10–100 pmol primer is required. The concentration of target DNA can be as low as 10–15  $\mu\text{L}$ .

The reaction mix for PCR contains (a) the target DNA (b) a very large excess of the desired primers, (c) a thermostable DNA polymerase, and (d) four deoxyribonucleoside triphosphates. Only DNA polymerases that are able to function at the high temperatures can be employed in the PCR technique. *Taq polymerase* from the thermophilic bacterium *Thermus aquaticus* and the *Vent polymerase* from *Thermococcus litoralis* are the two popular enzymes used in the PCR.

The PCR cycle takes place in three steps as follows (Fig. 8-2):

- **Step 1:** The target DNA containing the sequence to be amplified is heat denatured to separate its complementary strands. Normally the target DNA is between 100 and 5000 bp in length.
- **Step 2:** The temperature is lowered so that the primers can anneal to the DNA on both sides of the target sequence. Because the primers are present in excess, the targeted DNA strands normally anneal to the primers rather than to each other.
- **Step 3:** DNA polymerase extends the primers and synthesizes copies of the target DNA sequence using the deoxyribonucleoside triphosphates.

At the end of one cycle, the targeted sequences on both strands are copied. When the three-step cycle is repeated, the four strands from the first cycle are copied to produce eight fragments. The third cycle yields 16 products. Theoretically, 20 cycles will produce about one million copies of the target DNA sequence, and 30 cycles yield around one billion copies.

The PCR technique has now been automated and is carried out through a specially designed machine called thermocycler. Currently, a thermocycler or PCR machine can carry out 25 cycles and amplify DNA  $10^5$  times in as little as 57 minutes. During a typical cycle, the DNA is denatured at 94°C for 15 seconds; then the primers are annealed and extended (steps 2 and 3) at 68°C for 60 seconds. PCR technology is improving continually and undergoing many changes as follows:

1. Nowadays, RNA can be efficiently used in PCR procedures. The *Tth* DNA polymerase, a recombinant *Thermus*

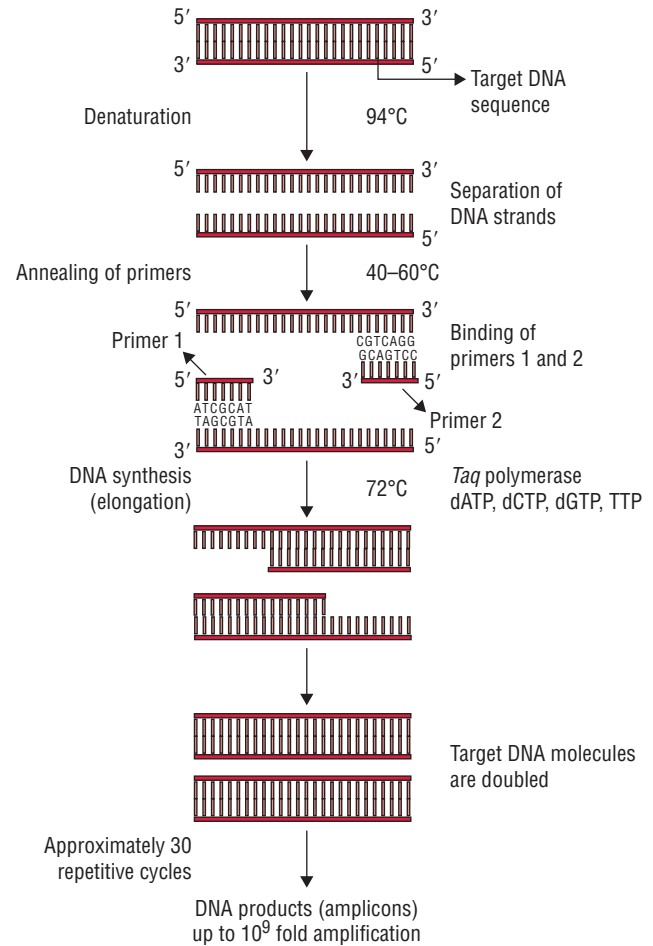

**FIG. 8-2.** A schematic diagram showing the principle of polymerase chain reaction.

*thermophilus* DNA polymerase, will transcribe RNA to DNA and then amplify the DNA. Cellular RNAs and RNA viruses may be studied even when the RNA is present in very small amounts (as few as 100 copies can be transcribed and amplified).

2. Also, PCR can quantitate DNA products without the use of isotopes. This allows one to find the initial amount of target DNA in less than an hour using automated equipment. Quantitative PCR is quite valuable in virology and gene expression studies.
3. As mentioned earlier, the target DNA to be amplified is normally less than about 5000 bp in length. A long PCR technique has been developed that will amplify sequences up to 42 kilo bases long. It depends on the use of error-correcting polymerases because *Taq* polymerase is error-prone.
4. **Multiplex PCR** is another modification of PCR in which two or more target sequences can be demonstrated simultaneously in a single specimen at the same time. This method uses two or more primer sets designed for amplification of different targets. Multiplex is now increasingly evaluated for simultaneous demonstration of two or more pathogens in a clinical specimen.

5. *Real-time PCR* is the most recent development. It is so named, because the PCR amplicons can be detected in real time. In fact, “real time” refers to the detection of amplicons after each PCR cycle. Several commercial instruments are available that combine PCR amplification of target DNA with detection of amplicons in the same closed vessel. Probe detection formats involve detecting fluorophores. Results are semiquantitative and can be obtained in considerably less time than it takes to perform a conventional PCR assay.

## Key Points

### Applications of PCR

The PCR and other molecular techniques have already proven exceptionally valuable in many areas of molecular biology, medicine, and biotechnology. These methods are useful to:

- Amplify very small quantities of a specific DNA and provide sufficient material for accurately sequencing the fragment or cloning it by standard techniques.
- Detect previously unrecognized or uncultivable microorganisms.
- Detect the genes responsible for drug resistance. They supplement conventional antimicrobial susceptibility testing for the detection of methicillin resistance in staphylococci, rifampicin resistance in *M. tuberculosis*, etc.
- Predict and monitor response of individuals chronically infected with hepatitis B virus (HBV), hepatitis C virus (HCV), or HIV to antiviral therapy.
- Provide useful information that may predict progression of the disease. Determination of HIV-1 viral load as a predictor of progression to AIDS is an example of such use.
- Diagnose AIDS, Lyme disease, chlamydia, tuberculosis, hepatitis, the human papilloma virus, and other infectious agents.
- Detect genetic diseases, such as sickle cell anemia, phenylketonuria, and muscular dystrophy.

- **Plasmids** are excellent vectors because they are small, well characterized, easy to manipulate, and they can be transferred into appropriate host cells through transformation. *E. coli* plasmid carries genetic markers for resistance to antibiotics, although it is restricted by the relatively small amount of foreign DNA it can accept.
- **Bacteriophages** are also good vectors because they have natural ability to inject DNA into bacterial hosts through transduction. The *Charon2* phage is a modified phage vector that lacks a large part of its genome; hence it can carry a fairly large segment of foreign DNA.
- **Hybrid vectors** have been developed by splicing two different vectors together. A *cosmid* is an example of a hybrid vector that combines a plasmid and a phage and is capable of carrying relatively large genomic sequences. A hybrid *E. coli*-yeast vector can be inserted in both bacterial and yeast cloning hosts.

### Cloning hosts

*E. coli* is the traditional cloning host that is still used in the majority of experiments. This is because this bacterium was the original recombinant host and the protocols using it are well established, relatively easy, and reliable. Hundreds of specialized cloning vectors have been developed for it. The main disadvantage with *E. coli* is its lack of versatility in correctly expressing eukaryotic genes.

The yeast *Saccharomyces cerevisiae* is another alternative host used for certain industrial processes and research. This host being eukaryotic already possesses mechanisms for processing and modifying eukaryotic gene products. Certain techniques may also employ different bacteria (*Bacillus subtilis*), animal cell culture, and even live animals and plants to serve as cloning hosts.

## Recombinant DNA Technology

In recombinant DNA technology, first, the DNA responsible for a particular phenotype is identified and isolated. Once purified, the gene or genes are fused with other pieces of DNA to form recombinant DNA molecules. These are propagated (gene cloning) by insertion into an organism that need not even be in the same kingdom as the original gene donor.

### Cloning Vectors and Hosts

A good recombinant vector has two indispensable qualities: it must be capable of carrying a significant piece of the donor DNA and it must be readily accepted by the cloning host.

#### Cloning vectors

Cloned vectors include: (a) plasmids, (b) bacteriophages, and (c) hybrid vectors.

## Biological Products of Recombinant DNA Technology

Recombinant DNA technology is used by pharmaceutical companies to manufacture medicines that cannot be manufactured by any other means. Diseases, such as diabetes and dwarfism, caused by lack of an essential hormone are now being treated by replacing the genes of missing hormone. Porcine and bovine insulin were once the only forms available to treat diabetes, even though such animal products used to cause allergic reactions in certain sensitive individuals. In contrast, dwarfism that cannot be treated with animal growth hormones was treated only with human growth hormone (HGH) obtained from the pituitaries of cadavers. At one time, not enough HGH was available to treat thousands of children in need. However, now the scenario is changed by advent of recombinant HGH. Recombinant technology has changed the outcome of these and many other conditions by enabling large-scale manufacture of lifesaving hormones and enzymes of human origin.

## Genetically Modified Organisms

The process of artificially introducing foreign genes into organisms is termed **transfection**, and the recombinant organisms produced in this way are called **transgenic** or genetically modified organisms.

Foreign genes have been inserted into a variety of microbes, plants, and animals through recombinant DNA techniques developed especially for them. Transgenic “designer” organisms are available for a variety of biotechnological applications. Because they are unique life forms that would never have otherwise occurred, they can be patented.

## Gene Therapy

Gene therapy is a technique for replacing a faulty gene with a normal one in individuals with fatal or extremely debilitating genetic diseases. The inherent benefit of this therapy is to permanently cure the physiological dysfunction by repairing the genetic defect.

There are two strategies for this therapy: the *ex vivo* therapy and the *in vivo* therapy. In *ex vivo* therapy, the normal gene is cloned in vectors, such as retroviruses (e.g., mouse leukemia virus) or adenoviruses that are infectious but relatively harmless. Tissues removed from the patient are incubated with these genetically modified viruses to transfect them with the normal gene. The transfected cells are then reintroduced into patient’s body by transfusion. In contrast, the *in vivo* type of therapy does not have the intermediate step of incubating excised patient tissue. Instead, the naked DNA or a virus vector is directly introduced into the patient’s tissues.

The first gene therapy experiment in humans was started in 1990 by researchers at the National Institutes of Health, USA. The subject was a 4-year-old girl suffering from a severe immunodeficiency disease caused by the lack of enzyme adenosine deaminase (ADA). She was transfused with her own blood cells that had been engineered to contain a functional ADA gene. Later, other children were given the same type of therapy. So far, the children have shown remarkable improvement and continue to be healthy, but the treatment is not permanent and must be repeated. Proper scientific controlled trials are required before induction of it as a routine clinical practice.

# Antimicrobial Agents: Therapy and Resistance

## Introduction

Any chemical used in treatment, relief, or prophylaxis of disease is defined as a *chemotherapeutic drug* or agent. When chemotherapeutic drugs are given as a means to control infection, the practice is termed *antimicrobial chemotherapy*. Antimicrobial drugs (also termed anti-infective drugs) are a special class of compounds capable even in high dilutions of destroying or inhibiting microorganisms. The origin of modern antimicrobial drugs is varied.

The *antibiotics* are substances produced by the natural metabolic processes of some microorganisms that can inhibit or destroy other microorganisms. *Synthetic antimicrobial drugs* are derived in laboratory from dyes or other organic compounds through chemical reactions. Although division into these two categories has been traditional, they tend to overlap, because most antibiotics, termed *semisynthetic antibiotics*, are now chemically altered in laboratory. The current trend is to use the term *antimicrobial* for all antimicrobial drugs, regardless of origin. Antimicrobial drugs vary in their spectrum of activities. They may be broad-spectrum or narrow-spectrum antibiotics.

- **Broad-spectrum or extended-spectrum** antibiotics are active against a wider range of different microbes. For example, tetracyclines are active against a variety of Gram-positive and Gram-negative bacteria, rickettsiae, mycoplasmas, and even protozoa.
- **Narrow-spectrum** antibiotics are effective against one or very few microbes. For example, vancomycin is active against certain Gram-positive bacteria (such as staphylococci and enterococci) or griseofulvin, which is used only against fungal skin infections.

## Mechanisms of Action of Antimicrobial Drugs

Antimicrobial drugs may be bactericidal or bacteriostatic. A bactericidal drug kills bacteria, whereas a bacteriostatic drug inhibits the growth of bacteria, but does not kill them.

- Bactericidal drugs are very much useful in (a) life-threatening situations, (b) endocarditis, (c) patients with low polymorphonuclear count (below 500/ $\mu$ L), and (d) conditions in which bacteriostatic drugs do not cause a cure.
- The bacteriostatic drugs depend on the host defense mechanisms, such as phagocytes to kill the bacteria. Hence, these drugs are not used when the patient has too few neutrophils.

Antibiotics act against bacteria by the following mechanisms:

1. Inhibition of cell wall synthesis
2. Inhibition of protein synthesis
3. Inhibition of nucleic acid synthesis
4. Alteration of cell membrane function

## Inhibition of Cell Wall Synthesis

Penicillins, cephalosporins, and vancomycin are the antibiotics that act against bacteria by interfering with their cell wall synthesis. Penicillins and cephalosporins are called  $\beta$ -lactam antibiotics because they possess an intact  $\beta$ -lactam ring essential for antimicrobial activity.

### ► Penicillins

The penicillins are called  $\beta$ -lactam antibiotics because they have a common chemical nucleus (6-aminopenicillanic acid) that contains a  $\beta$ -lactam ring. They are bactericidal antibiotics that act by inhibiting bacterial cell wall synthesis. They act primarily against Gram-positive organisms. Other penicillins, such as ampicillin, amoxicillin, carbenicillin, ticarcillin, piperacillin, etc., act against both Gram-positive and Gram-negative organisms. Penicillins kill bacteria by the following mechanisms:

- Penicillins kill bacteria during their growing stage and are more active against replicating bacteria during the log phase than the lag phase of the bacterial growth curve.
- The intact peptidoglycan in the cell wall of the bacteria has chains of *N*-acetyl muramic acid (NAM) and *N*-acetyl glucosamine (NAG) glycans cross-linked by peptide bridges. Penicillins and cephalosporins act by inhibiting penicillin-binding proteins (PBPs), also known as transpeptidases, that link the cross-bridges between NAMs, thereby, greatly weakening the cell wall meshwork. *Streptococcus pneumoniae* is an example of bacteria that show resistance against penicillins due to mutations that occur in the genes encoding PBPs.

### ► Cephalosporins

Cephalosporins like penicillins are  $\beta$ -lactam antibiotics. However, they differ from penicillins in having 7-amino-cephalosporanic acid instead of 6-aminopenicillanic acid in their structure. They exhibit bactericidal activity similar to that of penicillin. They are effective against a wide variety of bacterial pathogens.

TABLE 9-1

List of cephalosporins used in clinical practice

	First generation	Second generation	Third generation	Fourth generation
<b>Drugs</b>	Cephalexin, cephalothin, cephadrine, cephaloridine	Cefoxitin, cefaclor, cefamandole, cefuroxime, cefprozil, cefmetazole	Cefoperazone, cefotaxime, ceftazidime, ceftizoxime, ceftriaxone, cefixime	Cefpirome, cefepime
<b>Antibacterial activity</b>	<p><b>Gram-positive bacteria:</b> <i>Staphylococcus aureus</i>, <i>Streptococcus</i> spp. except enterococci</p> <p><b>Gram-negative bacteria:</b> <i>Escherichia coli</i>, <i>Klebsiella</i>, <i>Haemophilus influenzae</i>, <i>Proteus mirabilis</i></p>	<p>First-generation spectrum +</p> <p><i>Enterobacter</i> spp., <i>Serratia</i> spp., <i>Proteus vulgaris</i>, <i>Citrobacter</i> spp.</p> <p>+</p> <p>Gram-negative anaerobes</p>	<p>Second-generation spectrum +</p> <p><i>Pseudomonas aeruginosa</i>, <i>Neisseria gonorrhoeae</i> including <math>\beta</math>-lactamase-producing strains</p>	<p>Third-generation spectrum +</p> <p>extended Gram-negative coverage including <i>Citrobacter</i> spp. and <i>Enterobacter</i> spp. resistant to third-generation cephalosporins</p>

- First-generation cephalosporins are active mainly against Gram-positive cocci.
- Second-, third-, and fourth-generation cephalosporins are active primarily against Gram-negative bacilli.

The important cephalosporins are listed in Table 9-1.

Carbapenems (such as imipenem) and monobactams (such as aztreonam) are other examples of  $\beta$ -lactam antibiotics, but these are structurally different from penicillins and cephalosporins.

### ▶ Vancomycin

Vancomycin is a glycopeptide, but its mode of action is very similar to that of  $\beta$ -lactam antibiotics, such as penicillins and cephalosporins. It kills bacteria by inhibiting their cell wall synthesis. Vancomycin is a bactericidal antibiotic and is used:

- Most widely against *Clostridium* spp. and *Staphylococcus* spp. infections;
- Orally for treatment of antibiotics-associated colitis; and
- Also for treatment of methicillin-resistant *Staphylococcus aureus* (MRSA) infections.

### ▶ Teicoplanin

Teicoplanin is a glycopeptide antibiotic extracted from *Actinoplanes teichomyceticus*, with a similar spectrum of activity to vancomycin. Its mechanism of action is to inhibit bacterial cell wall synthesis. Teicoplanin is used in:

- Prophylaxis and treatment of serious infections caused by Gram-positive bacteria, including MRSA and *Enterococcus faecalis*.
- Treatment of pseudomembranous colitis and *Clostridium difficile*-associated diarrhea, with comparable efficacy with vancomycin. Its strength is considered to be due to the length of the hydrocarbon chain.

## Inhibition of Protein Synthesis

Bacteria have 30S and 50S ribosomal units, whereas mammalian cells have 80S ribosomes. The subunits of each type of ribosome, their chemical composition, and their functional specificities are sufficiently different, which explains why these

antimicrobial drugs can inhibit protein synthesis in bacterial ribosomes without having a major effect on mammalian ribosomes.

Aminoglycosides and tetracyclines act at the level of 30S ribosomal subunits, whereas erythromycins, chloramphenicol, and clindamycins act at the level of 50S ribosomal subunits (Fig. 9-1).

### ▶ Aminoglycosides

Aminoglycosides are a family of drugs that include streptomycin, gentamicin, tobramycin, amikacin, and neomycin, which are increasingly used in different clinical conditions. They kill bacteria by inhibiting protein synthesis. They do so by binding to the 30S subunit ribosome, which blocks the initiation complex, leading to no formation of peptide bonds or polysomes. They act mostly against Gram-negative bacteria.

### ▶ Tetracyclines

Tetracyclines are a family of drugs that include dimethylchlorotetracyclines, doxycycline, and rolitetracycline. They are bacteriostatic drugs. They act by inhibiting protein synthesis of the bacteria by blocking the binding of aminoacyl t-RNA to the 30S ribosomal subunits. Therefore, they prevent introduction of new amino acids to the nascent peptide chain. The action is usually inhibitory and reversible upon withdrawal of the drug. They are variably effective in infections caused by both cocci and bacilli. They are also highly effective against rickettsial and chlamydial infections. Doxycycline, dimethylchlorotetracycline, and rolitetracycline are the examples of semisynthetic tetracyclines.

### ▶ Macrolides

Macrolides (such as erythromycin, azithromycin, clarithromycin, and roxithromycin) have a macrolide ring to which sugars are attached. They are bacteriostatic antibiotics. They act by inhibiting protein synthesis of the bacteria by blocking the release of the t-RNA after it has transferred its amino acids to the growing polypeptide. Erythromycin is effective against Gram-positive cocci including MRSA, *Neisseria* spp., and *Haemophilus influenzae*.

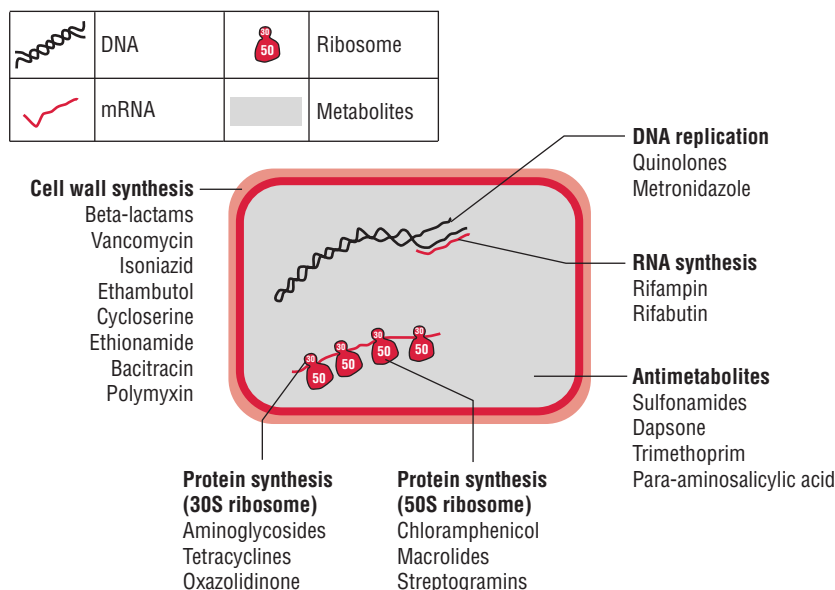

FIG. 9-1. Schematic diagram showing various mechanisms of actions of antibiotics.

## ► Chloramphenicol

Chloramphenicol is mainly a bacteriostatic agent, and growth of bacteria resumes when the drug is withdrawn. It acts by binding to the 50S subunit of the ribosome and blocking peptidyl transferase, the enzyme that delivers the amino acid to the growing polypeptide, resulting in the inhibition of bacterial protein synthesis. Chloramphenicol is used less frequently nowadays.

## ► Clindamycin

The mode of action of clindamycin is similar to that of erythromycin. It inhibits bacterial protein synthesis by blocking the release of t-RNA after it has transferred its amino acids to the growing polypeptide.

## Inhibition of Nucleic Acid Synthesis

Sulfonamides, trimethoprim, quinolones, and rifampin are examples of drugs that act by inhibition of nucleic acid synthesis.

## ► Sulfonamides and trimethoprim

Sulfonamides and trimethoprim inhibit nucleic acid synthesis by inhibiting nucleotide synthesis. Sulfonamides are structural analogs of para-aminobenzoic acid (PABA). Due to structural similarity to PABA, sulfonamide competes with the latter during bacterial metabolism. Sulfonamides enter into the reaction in place of PABA and compete for the active center of the enzyme. As a result, nonfunctional analogs of folic acid are formed, preventing further growth of the bacterial cell. The inhibitory action of sulfonamides on bacterial growth can be counteracted by an excess of PABA in the environment (competitive inhibition). Many other bacteria, however, synthesize folic acid, as mentioned above, and consequently are susceptible to action by sulfonamides. Sulfonamides are bacteriostatic drugs effective against a variety of Gram-negative and Gram-positive bacteria.

Trimethoprim (3,4,5-trimethoxybenzylpyrimidine) is a bacteriostatic drug active against both Gram-positive and Gram-negative organisms. The compound inhibits the enzyme dihydrofolic acid reductase 50,000 times more efficiently in bacteria than in mammalian cells. This enzyme reduces dihydrofolic to tetrahydrofolic acid, leading to decreased synthesis of purines and ultimately of DNA.

Sulfonamides and trimethoprim inhibit the synthesis of tetrahydrofolic acid, the main donor of the methyl groups that are essential to synthesize adenine, guanine, and cytosine.

### Key Points

- Sulfonamides and trimethoprim, each can be used alone to inhibit bacterial growth.
- If used together, they produce sequential blocking, resulting in a marked enhancement (*synergism*) of activity. Such mixtures of sulfonamide (five parts) plus trimethoprim (one part) have been used in the treatment of pneumocystis pneumonia, malaria, shigella enteritis, systemic salmonella infections, urinary tract infections, and many others.

## ► Quinolones

Quinolones are synthetic analogs of nalidixic acid. They are a family of drugs that include ciprofloxacin, ofloxacin, and levofloxacin. They are bactericidal and act by inhibiting bacterial DNA synthesis by blocking *DNA gyrase*. DNA gyrase is the enzyme that unwinds DNA strands, so they can be replicated. Quinolones are effective against both Gram-positive and Gram-negative organisms.

## ► Rifampin

Rifampin inhibits bacterial growth by binding strongly to the DNA-dependent RNA polymerase of bacteria. Thus, it inhibits bacterial RNA synthesis. The mechanism of rifampin action on viruses is different. It blocks a late stage in the assembly of poxviruses.

## Alteration of Cell Membrane Function

The cytoplasm of all living cells is surrounded by the cytoplasmic membrane, which serves as a selective permeability barrier. The cytoplasmic membrane carries out active transport functions, and thus controls the internal composition of the cell. If the functional integrity of the cytoplasmic membrane is disrupted, macromolecules and ions escape from the cell, and cell damage or death ensues. The cytoplasmic membrane of bacteria and fungi has a structure different from that of animal cells and can be more readily disrupted by certain agents. Consequently, selective chemotherapy is possible.

Antifungal drugs act by altering the cell membrane function of the fungi. They show selective toxicity because cell membrane of the fungi contains ergosterol, while human cell membrane has cholesterol. Bacteria with the exception of *Mycoplasma* do not have sterols in their cell membranes, hence are resistant to action of these drugs.

### Key Points

- Amphotericin B and azoles are the frequently used antifungal drugs. Amphotericin B acts against fungi by disrupting the cell membrane by binding at the site of ergosterol in the membrane. Azoles (such as ketoconazole, fluconazole, itraconazole, and clotrimazole) inhibit synthesis of ergosterol, hence are toxic to fungi.
- Polymyxin B is an antibiotic primarily used for resistant Gram-negative infections. It is derived from the bacterium *Bacillus polymyxa*. Polymyxin B is a mixture of two closely related compounds—polymyxin B1 and polymyxin B2. It has a bactericidal action against almost all Gram-negative bacilli except the *Proteus* group.

Polymyxins bind to the cell membrane and alter its structure, making it more permeable. The resulting water uptake leads to cell death. They are cationic, basic proteins that act like detergents (surfactants). Side-effects include neurotoxicity and acute renal tubular necrosis. It is commonly used in the topical first-aid preparation.

Cellular target sites of antimicrobial drugs are listed in Table 9-2.

TABLE 9-2 Cellular target sites of antibiotics

Drug	Target site	Mechanism of action
<b>β-lactams</b>	Cell wall	Bactericidal, interfere with cross-linking of cell wall peptidoglycan molecules
<b>Erythromycin, fusidic acid, tetracycline</b>	Ribosomes	Bacteriostatic or bactericidal, interfere with translocation and attachment of t-RNA, thus inhibiting protein synthesis
<b>Polyenes</b>	Cytoplasmic membrane	Bacteriostatic, disrupt yeast cell membrane
<b>Metronidazole, idoxuridine, acyclovir</b>	Nucleic acid replication	Bactericidal, interfere with DNA replication

## Resistance to Antimicrobial Drugs

Bacterial resistance to drugs is a condition in which the bacteria that were earlier susceptible to antibiotics develop resistance against the same antibiotics and are not susceptible to the action of these antibiotics. Antibiotic resistance among bacteria is a major concern in the treatment of a patient. Emergence of antibiotic resistance to the old as well as new antibiotics by bacteria is posing a major challenge in the treatment of infections caused by bacteria.

Antibiotic resistance is seen more commonly in hospital-acquired infections than in community-acquired infections. The antibiotic-resistant bacteria are more commonly seen in hospital environment due to widespread use of antibiotics in hospitals that select for these bacteria. These hospital strains of bacteria are characterized by developing resistance to multiple antibiotics at the same time. Common examples of such strains of bacteria showing drug resistance include hospital strains of *S. aureus* and Gram-negative enteric bacteria, such as *Escherichia coli* and *Pseudomonas aeruginosa*. Resistance to multiple antibiotics is mediated by plasmid-carrying several genes that encode enzymes responsible for the resistance.

### Mechanisms of Antibiotic Resistance

There are many different mechanisms by which microorganisms might exhibit resistance to drugs (Fig. 9-2). These are (a) production of enzymes, (b) production of altered enzymes, (c) synthesis of modified targets, (d) alteration of permeability of cell wall, (e) alteration of metabolic pathways, and (f) efflux pump as follows:

#### ► Production of enzymes

Bacteria produce enzymes that inactivate antibiotics. For example, penicillin-resistant staphylococci produce an enzyme β-lactamase that destroys the penicillins and cephalosporins by splitting the β-lactam ring of the drug. Gram-negative bacteria resistant to aminoglycosides, mediated by a plasmid, produce adenylating, phosphorylating, or acetylating enzymes that destroy the drug.

#### ► Production of altered enzymes

Certain microorganisms develop an altered enzyme that can still perform its metabolic function, but is much less affected by the drug. For example, in trimethoprim-resistant bacteria, the dihydrofolic acid reductase is inhibited far less efficiently than in trimethoprim-susceptible bacteria.

#### ► Synthesis of modified targets

Certain bacteria produce modified targets against which the antibiotic has no effect. For example, a methylated 23S ribosomal RNA can result in resistance to erythromycin, and a mutant protein in the 50S ribosomal subunits can result in resistance to streptomycin. Penicillin resistance in *S. pneumoniae* and enterococci is caused by the loss or alteration of PBPs.



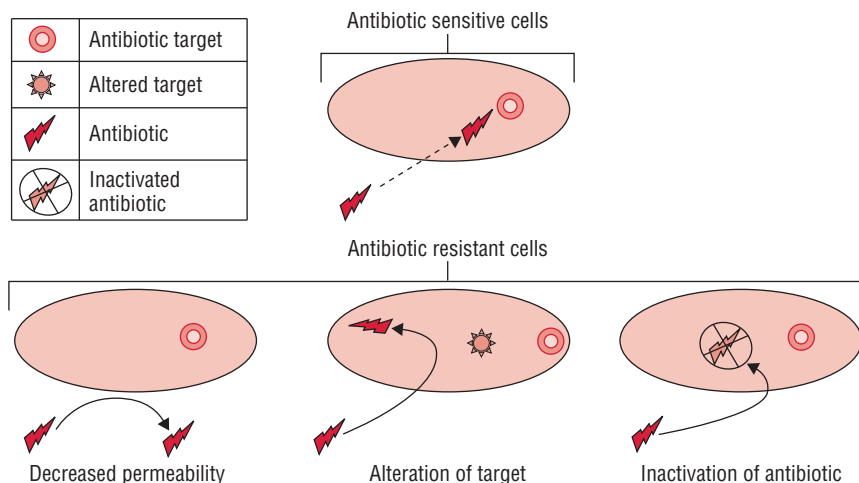

FIG. 9-2. Schematic diagram showing the mechanisms of drug resistance in antibiotics.

### ► Alteration of permeability of cell wall

Some bacteria develop resistance to antibiotic by changing their permeability to the drug in such a way that an effective intracellular concentration of the antibiotic is not achieved inside the bacterial cell. For example, *P. aeruginosa* develops resistance against tetracyclines by changing its porins that can reduce the amount of tetracycline entering the bacteria, thereby developing resistance to the antibiotics.

Resistance to polymyxins is also associated with a change in permeability to the drugs. Streptococci have a natural permeability barrier to aminoglycosides. This can be partly overcome by the simultaneous presence of a cell wall-active drug, e.g., penicillin.

### ► Alteration of metabolic pathways

Bacteria may develop resistance by altering metabolic pathway that bypasses the reaction inhibited by the drug. For example, certain sulfonamide-resistant bacteria do not require extracellular PABA but, like mammalian cells, can utilize preformed folic acid.

### ► Efflux pumps

Efflux pumps have been found to be responsible for conferring resistance to many groups of antibiotics including aminoglycosides, quinolones, etc. The major family of bacterial efflux pumps include ABC (ATP-binding cassette) multidrug efflux pump, multidrug resistance and toxic compound extrusion (MATE) efflux pumps, major facilitator superfamily efflux (MFSE) pumps, etc.

## Basis of Resistance

Resistance by bacteria against antibiotic may be classified as:

1. Nongenetic basis
2. Genetic basis

## Nongenetic Basis of Resistance

Nongenetic basis of resistance plays a less important role in the development of drug resistance:

1. Certain bacteria under ordinary circumstances are usually killed by penicillins. But these bacteria, if lose their cell wall and become protoplast, become nonsusceptible to the action of cell wall-acting drug such as penicillins.
2. In certain conditions, such as in the abscess cavity, bacteria can be walled off, which prevents drugs to penetrate effectively into bacteria. Surgical drainage of pus, however, makes these bacteria again susceptible to the action of antibiotics.
3. Presence of foreign bodies (such as surgical implants and catheters) and penetration injury caused by splinters and sharpeners make successful antibiotic treatment more difficult.
4. Nonreplicating bacteria in their resting stage are less sensitive to the action of cell wall inhibitors such as penicillin and cephalosporins. This is particularly true for certain bacteria such as *Mycobacterium tuberculosis* that remains in resting stage in tissues for many years, during which it is insensitive to drugs. However, when these bacteria begin to multiply, they become susceptible to antibiotics.

## Genetic Basis of Drug Resistance

The genetic basis of drug resistance, mediated by genetic change in bacteria, is most important in the development of drug resistance in bacteria. This is of three types as follows: (a) chromosome-mediated resistance, (b) plasmid-mediated resistance, and (c) transposons-mediated resistance.

### ► Chromosome-mediated resistance

Chromosome-mediated resistance occurs as a result of spontaneous mutation. This is caused by mutation in the gene that codes for either the target of drug or the transport system in the membrane of the cell wall, which controls the entry of drugs into cells. The frequency of chromosomal mutation is much less than the plasmid-mediated resistance. It varies between  $10^{-7}$  and  $10^{-9}$ .

## Key Points

Mutational resistance in *M. tuberculosis* is of much importance in the treatment of tuberculosis:

- Treatment of tuberculosis with two or more antitubercular drugs is carried out to prevent emergence of multidrug resistance in the tuberculosis.
- This is based on the principle that it is most unlikely that the bacterium, *M. tuberculosis*, becomes concurrently resistant to all the antibiotics given simultaneously. There is less likely resistant mutation because on treatment with antitubercular drugs, a mutant of *M. tuberculosis* resistant to one drug, if appears, will be destroyed by the other drug.

### ► Plasmid-mediated resistance

Plasmid-mediated drug resistance in bacteria occurs by transfer of plasmid and genetic materials. It is mediated by resistance plasmid, otherwise known as R factor.

**R factors:** These are circular, double-stranded DNA molecules that carry the genes responsible for resistance against variety of antibiotics. These factors may carry one or even two or more resistant genes. The genes encode for a variety of enzymes that destroy the antibiotics by degrading antibiotics or modify membrane transport system. For example, the genes code for enzymes like  $\beta$ -lactamases that destroy  $\beta$ -lactam ring (which is responsible for the antibactericidal action of  $\beta$ -lactam antibiotics, such as penicillins and cephalosporins). Table 9-3 lists different mechanisms of plasmid-mediated resistance in bacteria.

## Key Points

Plasmid-mediated resistance plays a very important role in antibiotics usage in clinical practice. This is because:

- A high rate of transfer of plasmids from one bacterium to another bacterium takes place by conjugation,
- Plasmids mediate resistance to multiple antibiotics, and
- Plasmid-mediated resistance occurs mostly in Gram-negative bacteria.

### ► Transposons-mediated drug resistance

Drug resistance is also mediated by transposons that often carry the drug resistance genes. Transposons are small pieces of DNA

TABLE 9-3

Plasmid-mediated antibiotic resistance

Antibiotic	Mechanism of resistance
$\beta$ -lactams	$\beta$ -lactamases break down the $\beta$ -lactam ring to an inactive form
Aminoglycosides	Aminoglycosides modifying enzymes: acetyltransferases, phosphotransferases, and nucleotidyltransferases
Erythromycin and clindamycin	Induced enzymatic activity due to methylating ribosomal RNA
Chloramphenicol	Acetylation of the antibiotic to an inactive form
Tetracycline	Alteration of cell membrane, decreases permeability to the antibiotic

TABLE 9-4

Differences between mutational and transferable drug resistance

Mutational drug resistance	Transferable drug resistance
Chromosome mediated	Plasmid mediated
Resistance to one drug	Resistance to multiple drugs
Resistance nontransferable	Resistance transferable
Virulence of organism lowered	Virulence of organism not lowered
Low-degree resistance	High-degree resistance
Due to decreased permeability, development of alternate metabolic pathway or inactivation of drug	Due to production of many degrading enzymes

that move from one site of the bacterial chromosome to another and from bacterial chromosome to plasmid DNA. Many R factors carry one or more transposons. Differences between chromosomal and transferable drug resistance is listed in Table 9-4.

## Specific Mechanisms of Resistance

### ► Penicillins and cephalosporins

Resistance to penicillin is mainly mediated by three mechanisms: (a) production of penicillin-destroying enzymes, (b) mutation genes coding for PBP, and (c) reduced permeability to drug.

#### 1. Production of penicillin-destroying enzymes ( $\beta$ -lactamases):

Resistance to penicillins may be determined by the organism's production of penicillin-destroying enzymes ( $\beta$ -lactamases).  $\beta$ -lactamases, such as penicillinases and cephalosporinases, open the  $\beta$ -lactam ring of penicillins and cephalosporins and abolish their antimicrobial activity.  $\beta$ -lactamases have been described for many species of Gram-positive and Gram-negative bacteria. Some  $\beta$ -lactamases are plasmid-mediated (e.g., penicillinase of *S. aureus*), while others are chromosomally mediated (e.g., many species of Gram-negative bacteria such as *Enterobacter* spp., *Citrobacter* spp., *Pseudomonas* spp., etc).

There is one group of  $\beta$ -lactamases that is occasionally found in certain species of Gram-negative bacilli, usually *Klebsiella pneumoniae* and *E. coli*. These enzymes are termed **extended-spectrum  $\beta$ -lactamases** because they confer upon bacteria an additional ability to hydrolyze the  $\beta$ -lactam rings of cefotaxime, ceftazidime, or aztreonam.

**2. Mutation in genes coding for PBP:** This form of resistance occurs due to the absence of some penicillin receptors (PBP) and occurs as a result of chromosomal mutation. This mechanism is responsible for both low-level and high-level resistance seen in *S. pneumoniae* to penicillin G and in *S. aureus* to nafcillin.

**3. Reduced permeability to drug:** Low-level resistance of *Neisseria gonorrhoeae* to penicillin is caused by poor permeability of the drug. However, high-level resistance is mediated by a plasmid coding for penicillinase.

Cephalosporins are resistant to  $\beta$ -lactamases in varying degrees.

### ► Vancomycin

Resistance to vancomycin is mediated by change in D-ALA-D-ALA part of peptide in the peptidoglycan to D-ALA-D-lactate.

This results in the inability of vancomycin to bind to the bacteria. Vancomycin resistance in *Enterococcus* spp. is being increasingly documented in different clinical conditions.

**Vancomycin-resistant enterococci (VRE):** VRE were first detected in Europe (United Kingdom and France) in 1986 and soon after, a Van B *Enterococcus faecalis* clinical isolate was reported in the United States. These have now been reported from Australia, Belgium, Canada, Denmark, Germany, Italy, Malaysia, Netherlands, Spain and Sweden. But the incidence of human VRE infections in European countries is relatively low (1–3%) compared with the high and rising rate in the US.

Seven types of glycopeptide resistance have been described among enterococci (VanA, VanB, VanC, VanD, VanE, VanG, and VanL), which are named based on their specific ligase genes (e.g., *vanA*, *vanB*, etc.). Related gene clusters have been found in non-pathogenic organisms. The common endpoint of these phenotypes is the formation of a peptidoglycan precursor with decreased affinity for glycopeptides, resulting in decreased inhibition of peptidoglycan synthesis. Peptidoglycan precursors ending in the depsipeptide d-alanyl-d-lactate are produced in VanA, VanB, and VanD strains, whereas VanC, VanE, and VanL (recently described in an *E. faecalis* strain) isolates produce precursors terminating in d-alanyl-d-serine, instead of the normally occurring d-alanyl-d-alanine.

The *vanA* gene cluster was originally detected in the Tn1546 transposon, and this or related genetic elements are usually carried by plasmids and occasionally by host chromosome; this plasmid-borne transposon also has been found in clinical isolates of *S. aureus* (vancomycin-resistant *S. aureus* strains).

Glycopeptide resistance in enterococci is classified as either intrinsic (as a species characteristic) or acquired. The former is a characteristic of the motile species *Enterococcus gallinarum* and *Enterococcus casseliflavus/flavescens*, members of which all carry the naturally occurring *vanC-1* and *vanC-2/vanC-3* genes, respectively. These enterococci show variable MICs of vancomycin, with many falling in the susceptible range, and clinical failures have been reported following vancomycin use. In general, the isolation of these species does not require strict infection control isolation procedures, unless they are highly resistant, suggesting the added presence of potentially transferable *vanA* or *vanB* genes.

## Key Points

**Vancomycin-resistant *Staphylococcus aureus* (VRSA):** In 1997, the first clinical isolate of *S. aureus* with diminished susceptibility to vancomycin (strain Mu50) was described in Japan. This strain displayed a vancomycin MIC of 8 µg/mL, which is in the range of intermediate susceptibility (4–8 µg/mL) as per the current Clinical and Laboratory Standards Institute (CLSI) breakpoints, and thus was referred to as vancomycin-intermediate *S. aureus* (VISA) or glycopeptide-intermediate *S. aureus* (GISA).

This initial report was followed by others from various countries. Precursors of these VISA isolates are the heteroresistant-VISA (hVISA or hGISA) with subpopulations of cells that are able to grow at a vancomycin concentration of 8 µg/mL. As of late 2008, nine clinical isolates of vancomycin-resistant *S. aureus* (VRSA) harboring the enterococcal *vanA* gene have been described in the United States, with MICs ranging from 32 µg/mL to 1024 µg/mL.

## ▶ Aminoglycosides

Resistance to aminoglycosides is mediated by three important mechanisms as follows:

1. Plasmid-dependent resistance to aminoglycosides enzymes is the most important mechanism. It depends on the production of plasmid-mediated phosphorylating, adenylating, and acetylating enzymes that destroy the drugs.
2. Chromosomal resistance of microbes to aminoglycosides is the second mechanism. Chromosomal mutation in genes results in the lack of a specific protein receptor on the 30S subunit of the ribosome, essential for binding of drug.
3. A “permeability defect,” is the third mechanism of resistance. This leads to an outer membrane change that reduces active transport of the aminoglycoside into the cell so that the drug cannot reach the ribosome. Often this is plasmid-mediated.

## ▶ Tetracyclines

Resistance to tetracyclines occurs by three mechanisms: (a) efflux, (b) ribosomal protection, and (c) chemical modification. The first two are the most important. Efflux pumps, located in the bacterial cell cytoplasmic membrane, are responsible for pumping the drug out of the cell. *Tet* gene products are responsible for protecting the ribosome, possibly through mechanisms that induce conformational changes. These conformational changes either prevent binding of the tetracyclines or cause their dissociation from the ribosome. This is often plasmid controlled.

## ▶ Macrolides

Resistance to macrolides, such as erythromycin, is caused by a plasmid-encoded enzyme that methylates the 23S ribosomal RNA, thereby blocking binding of the drug.

## ▶ Sulfonamides and Trimethoprim

Resistance to sulfonamide is caused by plasmid-mediated transport system that actively exports the drug out of bacteria. It is also caused by chromosomal mutation in the gene that codes for the target enzyme dihydrofolate synthetase, resulting in reduced binding affinity of the drug.

Resistance to trimethoprim is caused by a chromosomal mutation in the gene coding for dihydrofolate reductase, the enzyme that reduces dihydrofolate to tetrahydrofolate.

## ▶ Quinolones

Resistance to quinolone occurs mainly due to chromosomal mutations that modify the bacterial DNA gyrase. Resistance is also caused by changes in the outer membrane proteins of the bacteria, which results in reduced uptake of drug into bacteria.

## ▶ Metronidazole

Metronidazole is a bactericidal drug that acts by inhibiting DNA synthesis. It is effective against anaerobes and protozoa.

### ► Chloramphenicol

Microorganisms resistant to chloramphenicol produce the enzyme chloramphenicol acetyltransferase that destroys drug activity. Production of this enzyme is usually mediated by a plasmid.

### ► Rifampin

Rifampin resistance results from a change in RNA polymerase due to a chromosomal mutation that occurs with high frequency.

### ► Antitubercular drugs

Antitubercular drugs include isoniazid, ethambutol, rifampin, pyrazinamide, and streptomycin.

- Isoniazid is a bacteriostatic agent. It penetrates well into tissue, fluid, and also acts on intracellular organisms. Resistance to isoniazid is mainly due to loss of enzyme catalase that activates isoniazid to active metabolites that inhibit synthesis of mycolic acid.
- Ethambutol acts by interfering RNA metabolism. The bacteria develop resistance due to mutation in the gene coding for arabinosyl transferase, which synthesizes arabinogalactan in the mycobacterial cell wall.
- Rifampin inhibits RNA synthesis. The bacteria develop resistance due to mutation in the gene coding for DNA-dependent RNA polymerases.
- Pyrazinamide resistance is due to mutation of gene coding for bacterial amidase, which converts it to its active form, pyrazinoic acid.

Combination therapy in tuberculosis is, therefore, essential to prevent emergence of drug resistance.

### ► Carbapenems

**Production of carbapenemases including NDM metallo-beta-lactamase:** *New Delhi metallo-beta-lactamase-1 (NDM-1)* is an enzyme that makes bacteria resistant to a broad range of beta-lactam antibiotics. These include the antibiotics of carbapenem family, which are a mainstay for the treatment of antibiotic-resistant bacterial infections. The gene for NDM-1 is one member of a large gene family that encodes beta-lactamase enzymes called carbapenemases. Bacteria that produce carbapenemases are often referred to in the news media as “superbugs” because infections caused by them are difficult to treat. Such bacteria are usually susceptible only to polymyxins and tigecycline.

NDM-1 was first detected in a *K. pneumoniae* isolate from a Swedish patient of Indian origin in 2008. It was later detected in bacteria in India, Pakistan, the United Kingdom, the United States, Canada, Japan, and Brazil. The most common bacteria that make this enzyme are Gram-negative such as *E. coli* and *K. pneumoniae*, but the gene for NDM-1 can spread from one strain of bacteria to another by horizontal gene transfer.

The NDM-1 enzyme was named after New Delhi, the capital city of India, as it was first described in December 2009 in a Swedish national who fell ill with an antibiotic-resistant bacterial infection that he acquired in India. The infection was unsuccessfully treated in a New Delhi hospital, and, after

the patient’s repatriation to Sweden, a carbapenem-resistant *K. pneumoniae* strain bearing the novel gene was identified. It was concluded that the new resistance mechanism “clearly arose in India, but there are few data arising from India to suggest how widespread it is.” Its exact geographical origin, however, has not been conclusively verified. In March 2010, a study in a hospital in Mumbai found that most carbapenem-resistant bacteria isolated from patients carried the *bla*NDM-1 gene.

In May 2010, a case of infection with *E. coli* expressing NDM-1 was reported in Coventry in the United Kingdom. The patient was a man of Indian origin who had visited India 18 months previously, where he had undergone dialysis. In initial assays, the bacterium was fully resistant to all antibiotics tested, while later tests found that it was susceptible to tigecycline and colistin. It is believed that international travel and patients’ use of multiple countries’ healthcare systems could lead to the “rapid spread of NDM-1 with potentially serious consequences”.

## Antibiotic Sensitivity Testing

Antibiotic sensitivity testing is carried out to determine the appropriate antibiotic agent to be used for a particular bacterial strain isolated from clinical specimens. Antibiotic sensitivity testing can be carried out by two broad methods, as follows:

1. Disc diffusion tests
2. Dilution tests

### Disc Diffusion Tests

Disc diffusion tests are the most commonly used methods in a laboratory to determine susceptibility of bacteria isolates to antibiotics. In this method, as the name suggests, discs impregnated with known concentrations of antibiotics are placed on agar plate that has been inoculated with a culture of the bacterium to be tested. The plate is incubated at 37°C for 18–24 hours. After diffusion, the concentration of antibiotic usually remains higher near the site of antibiotic disc, but decreases with distance. Susceptibility to the particular antibiotic is determined by measuring the zone of inhibition of bacterial growth around the disc (Fig. 9-3).

### ► Selection of media

The medium that supports both test and control strains is selected for carrying out antibiotic susceptibility testing of the bacteria. For example, Mueller–Hinton agar is used for testing Gram-negative bacilli and *Staphylococcus* spp., blood agar for *Streptococcus* spp. and *Enterococcus* spp. species, chocolate agar for *Haemophilus influenzae*, and Wellcotest medium for sulfonamides and cotrimoxazole.

The medium is prepared by pouring onto the flat horizontal surface of Petri dishes of 100 mm to a depth of 4 mm. The pH of the medium is maintained at 7.2–7.4. More alkaline pH increases the activity of tetracyclines, novobiocin, and fusidic acid, whereas an acidic pH reduced the activity of aminoglycosides and macrolides, such as erythromycin. The plates after preparation may be stored at 4°C for up to 1 week.

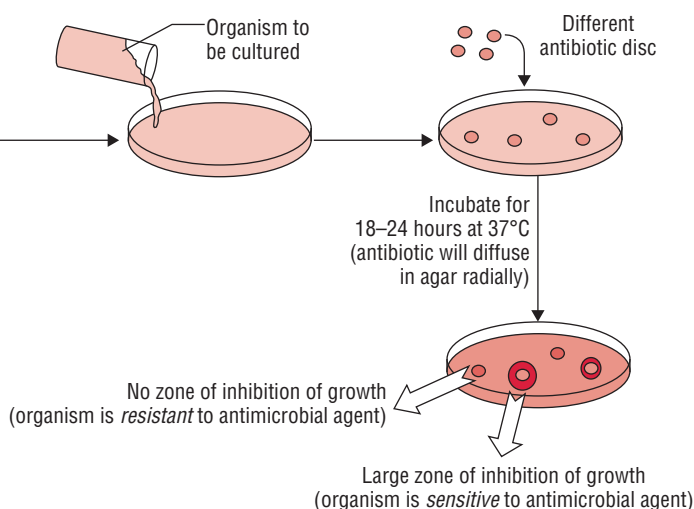

FIG. 9-3. Schematic diagram showing the performance of antibiotics sensitivity testing by disc diffusion method.

### ► Preparation of the inoculum

For testing antibiotic sensitivity, the bacteria are first isolated in pure culture on a solid medium. At least three to four morphologically similar colonies of the bacteria to be tested are touched and inoculated into appropriate broth and incubated at 37°C for 4–6 hours. The density of bacterial suspension in the broth is adjusted to  $1.5 \times 10^8$  cfu/mL by comparing its turbidity with that of 0.5 McFarland opacity standard tube. The broth is inoculated on the medium by streaking with sterile swabs. A sterile cotton swab is dipped into the broth and excess broth is removed by rotation of the swab against the sides of the tube above the fluid level.

### ► Antibiotic discs

Only the clinically relevant antibiotics are tested in antibiotic susceptibility tests. Antibiotic discs (6-mm filter paper discs) can be prepared from pure antimicrobial agents in laboratories or can be obtained commercially. The discs are applied with sterile forceps, a sharp needle, or a dispenser onto the surface of the medium, streaked with test strains, and the reading is reported after incubating the plate for 18–24 hours at 37°C aerobically.

### ► Types of disc diffusion tests

Disc diffusion tests are of the following types:

1. Kirby–Bauer disc diffusion method
2. Stokes disc diffusion method
3. Primary disc diffusion test

**Kirby–Bauer disc diffusion method:** Kirby–Bauer disc diffusion method is the most common method used routinely for determination of antibiotic sensitivity of bacteria isolated from clinical specimens. In this method, both the test strains and the control strains are tested in separate plates.

The test is performed by inoculating the test organism in a suitable broth solution, followed by incubation at 37°C for 2–4 hours. Then 0.1 mL of the broth is inoculated on the surface

of the agar medium by streaking with a sterile swab. In this method, either nutrient agar or Mueller–Hinton agar in Petri dishes is used. The inoculated medium is incubated overnight at 37°C. The susceptibility of drug is determined from the zones of inhibition of bacterial growth surrounding the antibiotic discs. The diameters of the zone of inhibition are calculated with vernier calipers or a thin transparent millimeter scale to the nearest millimeter. The point of abrupt diminution of the zone is considered as the zone edge. A maximum of six antibiotic discs are tested in a Petri dish of 85 mm size (Fig. 9-4).

Interpretation of the zone size is done as per the interpretation chart. Depending on the zone size, bacteria can be considered sensitive, intermediate or resistant to antibiotics.

**Stokes method:** This is a disc diffusion method, which makes use of inbuilt controls against many variables. In this method, the Petri dish containing the Mueller–Hinton agar is divided horizontally into three parts. The test strain is inoculated in the central area and the control strains on the upper and lower third of the plate. In modified Stokes method, control strain is inoculated in the central part but test strains are inoculated on the upper and lower third of the plate. The plates are incubated at 37°C and observed for zones of bacterial inhibition around the discs (Fig. 9-5). A maximum of six antibiotic discs can be applied on a 100 mm Petri dish.

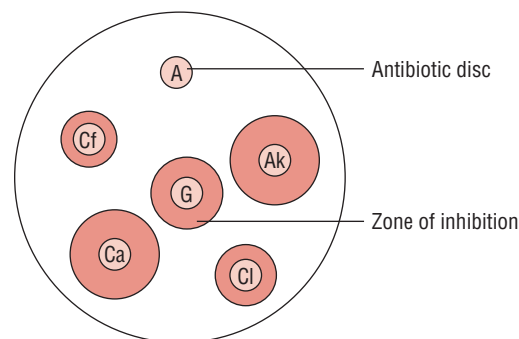

FIG. 9-4. Schematic diagram showing Kirby–Bauer disc diffusion method of antibiotic sensitivity.

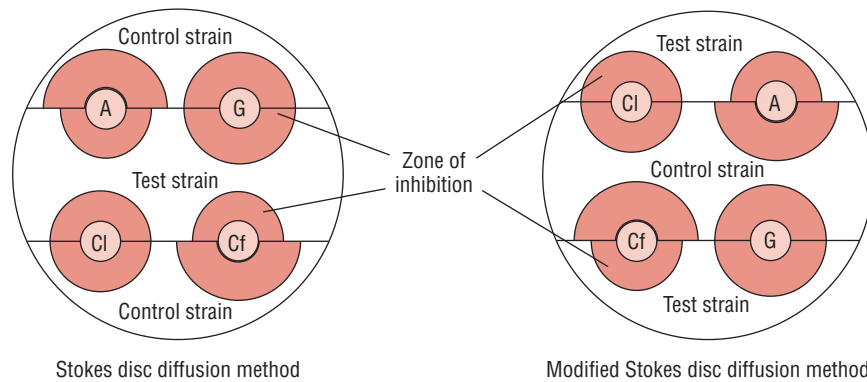

FIG. 9-5. Schematic diagram showing Stokes method of antibiotic sensitivity.

Reporting of the result is carried out by comparing the zones of inhibition of test and control bacteria. The zone sizes are measured from the edge of the disc to edge of the zone. It is interpreted as follows:

- **Sensitive (S):** The zone of test bacterium is equal to or more than that of control strain. The differences between the zone sizes of control and test strains should not be more than 3 mm if the zone size of the test bacterium is smaller than that of control.
- **Intermediate (I):** The zone size of the test bacterium should be at least 2 mm, and the differences between the zone of test and control strain should be at least 3 mm.
- **Resistant (R):** The zone size of the test bacterium is 2 mm or less.

**Interpretation of disc diffusion tests:** Results of disc diffusion tests, such as Kirby–Bauer and Stokes method, are interpreted as follows:

- **Sensitive (S):** Infection treatable by the normal dosage of the antibiotic.
- **Intermediate (I):** Infection may respond to higher dosage.
- **Resistant (R):** Unlikely to respond to usual dosage of the antibiotics.

However, for certain bacteria and antibiotic discs, the following may be kept in mind while interpreting results of disc diffusion tests:

1. *Proteus mirabilis*, *Proteus vulgaris*, and other bacteria producing swarming produce a thin film on agar surface often extending into the zones of inhibition. In such situations, the zones of swarming should be ignored and the outer clear margin should be measured to determine the zones of inhibition.
2. Many strains of MRSA grow very slowly in the presence of methicillin. They produce growth within the zone of inhibition on incubation for more than 48 hours. This problem can be overcome by incubating the bacteria at 30°C or by using 5% salt agar and incubating at 37°C.
3. Penicillinase producing strains of *Staphylococcus* often fail to secrete enough enzymes to neutralize penicillin close to the antibiotic disc. In such situation, it may show a zone of inhibition, but with the presence of large colonies at the

edge of the zone and without any gradual fading away of the growth of the bacteria toward the disc. In such condition, the zones of inhibition should not be considered, and it should be reported resistant irrespective of the zone size.

4. Trimethoprim and sulfamethoxazole should be tested separately to know whether the bacterium is sensitive to both or only to one of these. These should never be tested in combination, the way these two drugs are used in combination in clinical practice.

## Key Points

### Primary disc diffusion test

Primary disc diffusion test is a method carried out directly on clinical specimens unlike Kirby–Bauer or Stokes diffusion method that are performed on pure cultures of bacterial isolates from clinical specimens. In this method, the clinical specimen (e.g., urine) is inoculated uniformly on the surfaces of the agar to which antibiotic discs are applied directly. The plate is incubated overnight at 37°C for demonstration of zones of inhibition. This method is useful to know the antibiotic sensitivity results urgently, but results of this primary disc diffusion test should always be confirmed by testing the isolates subsequently by Kirby–Bauer or Stokes diffusion method.

## Dilution Tests

Dilution tests are performed to determine the minimum inhibitory concentration (MIC) of an antimicrobial agent. MIC is defined as the lowest concentration of an antimicrobial agent that inhibits the growth of organisms. Estimation of the MIC is useful to:

- Regulate the therapeutic dose of the antibiotic accurately in the treatment of many life-threatening situations, such as bacterial endocarditis.
- Test antimicrobial sensitivity patterns of slow-growing bacteria, such as *M. tuberculosis*.

Following methods are carried out to determine the MIC:

1. Broth dilution method
2. Agar dilution method
3. Epsilometer test (E-test)

## ► Broth dilution method

The broth dilution method is a quantitative method for determining the MIC of an antimicrobial agent that inhibits the growth of organisms *in vitro*. In this method, the antimicrobial agent is serially diluted in Mueller–Hinton broth by doubling dilution in tubes and then a standard suspension of the broth culture of test organism is added to each of the antibiotic dilutions and control tube. This is mixed gently and incubated at 37°C for 16–18 hours. An organism of known susceptibility is included as a control. The MIC is recorded by noting the lowest concentration of the drug at which there is no visible growth as demonstrated by the lack of turbidity in the tube. The main advantage of this method is that this is a simple procedure for testing a small number of isolates. The added advantage is that using the same tube, the minimum bactericidal concentration (MBC) of the bacteria can be determined.

The MBC is determined by subculturing from each tube, showing no growth on a nutrient agar without any antibiotics. Subcultures are made from each tube showing no growth into the nutrient agar plates without any antibiotics. The plates are examined for growth, if any, after incubation overnight at 37°C. The tube containing the lowest concentration of the drug that fails to show any growth on subculture plate is considered as the MBC of the antibiotic for that strain. Broth dilution may be of two types—macrodilution and microdilution. Broth microdilution is done using microtiter plates and is considered the “gold standard.”

## ► Agar dilution method

Agar dilution method is a quantitative method for determining the MIC of antimicrobial agent against the test organism.

### Key Points

Agar dilution method is useful:

- To test organisms from serious infections like bacterial endocarditis or
- To verify equivocal results of disc diffusion test.

Mueller–Hinton agar is used in this method. Serial dilution of the antibiotic are made in agar and poured onto Petri dishes. Dilutions are made in distilled water and added to the agar that has been melted and cooled to not more than 60°C. One control plate is inoculated without antibiotics. Organism to be tested is inoculated and incubated overnight at 37°C. Plates are examined for presence or absence of growth of the bacteria. The concentration at which bacterial growth is completely inhibited is considered as the MIC of the antibiotic.

The organisms are reported sensitive, intermediate, or resistant by comparing the test MIC values with that given in CLSI guidelines. The main advantage of the method is that a number of organisms can be tested simultaneously on each plate containing an antibiotic solution.

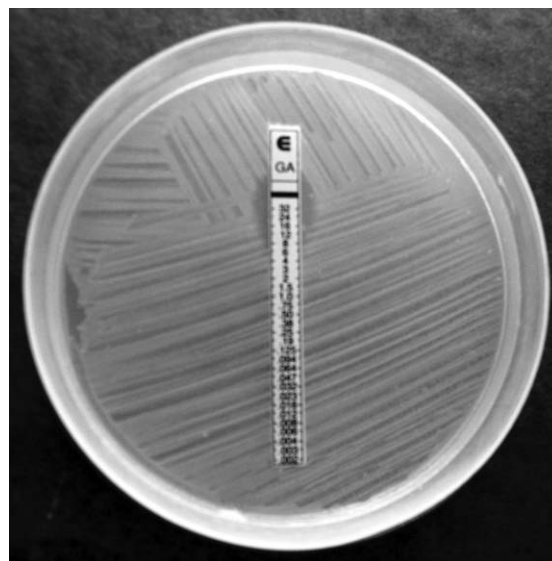

FIG. 9-6. Epsilon meter test (E-test).

## ► Epsilon meter test (E test)

Epsilon meter test (E test), based on the principle of disc diffusion, is an automated system for measuring MIC of a bacterial isolate. In this method, an absorbent plastic strip with a continuous gradient of antibiotic is immobilized on one side. MIC interpretative scale corresponding to 15 twofold MIC dilutions is used on the other side. The strip is placed on the agar plate inoculated with the test organism with the MIC scale facing toward the opening side of the plate. An elliptical zone of growth inhibition is seen around the strip after incubation at 37°C overnight. The MIC is read from the scale at the intersection of the zone with the strip. The end point is always read at complete inhibition of all growth including hazes and isolated colonies. E test is a very useful test for easy interpretation of the MIC of an antibiotic (Fig. 9-6).

## Antibacterial Assays in Body Fluids

Antibacterial assays are carried out to demonstrate the toxic and therapeutic level of the antibiotics in blood and other body fluids. In this method, the MIC of the antibiotic for the test organism is done first by standard broth dilution method. The test with patient’s serum is done concurrently. Serial dilutions of the patients’ serum in nutrient broth are carried out and to each a standard drop of culture is added and incubated for 18 hours. The highest dilution of serum which has inhibited growth of the assay organism is noted. This is equivalent to the MIC of the antibiotic in question. Multiplication of the MIC by the serum dilution gives the concentration of the antibiotic which was present in the patient’s undiluted serum.

# Microbial Pathogenesis

## Introduction

Host–parasite relationship is determined by the interaction between host factors and the infecting microorganisms. Outcome of any microbial infection depends on the interaction between the host and the parasite. The relationship of existence between the host and parasite may be (a) symbiosis, (b) commensalism, or (c) disease process:

- **Symbiosis** describes a situation where both the microorganisms and host species live together with mutual benefit. There is an element of symbiosis in the relationship between the human host and the gut flora; humans provide the bacteria with a warm, moist environment for their survival and gut flora provides a natural barrier against many invading pathogens.
- **Commensalism** is an association in which only the microorganism derives benefit, without causing any injury to the host. Most human microbes are commensals. They are present as bacterial flora of the skin and mucous membranes, including the upper respiratory tract, the lower gastrointestinal tract, and the vagina.
- **Disease** is caused by certain microorganisms known as *pathogens*. Microorganisms vary in their ability to cause disease in humans.

## Types of Microorganisms

Microorganisms may be of the following types:

1. **Saprophytes:** These are free-living microorganisms that live on dead or decaying organic matter. They are usually present in soil and water. They are generally unable to invade the living body.
2. **Parasites:** These are microorganisms that live on a living host and derive nutrition from the host without any benefit to the host and causes harm to the infected host.
3. **Commensals:** These are microorganisms that live on a living host without causing any injury to the host. Most human microbes are commensals.
4. **Pathogens:** A microorganism capable of causing disease, especially if it causes disease in immunocompetent people, is called as a *pathogen*. These pathogens, however, represent a very small proportion of the microbial species.
5. **Opportunistic pathogens:** A microbe that is capable of causing disease only in immunocompromised people is known

as *opportunistic pathogen*. These organisms can cause disease only if one or more of the usual defense mechanisms of humans are reduced or altered by accident, by intent (e.g., surgery), or by an underlying metabolic disorder or an infectious disease (e.g., AIDS).

There are two major differences between primary pathogens and opportunistic ones:

1. The first and foremost being that the primary pathogens regularly cause overt disease, whereas opportunistic ones take the opportunity offered by reduced host defenses to cause disease.
2. Long-term survival of a microbe is another difference. Long-term survival in a primary pathogen is absolutely dependent on its ability to replicate and to be transmitted in a particular host. However, this is not necessarily the case for a number of the opportunistic pathogens that infect humans.

## Infection

This is a process when an organism enters the body, increases in number, and causes damage to the host. All infections do not invariably result in the disease.

The term *infection* has more than one meaning: (a) the presence of microbes in the body and (b) the symptoms of the disease. The presence of microbes in the body does not always result in symptoms of the disease. Bacteria cause symptoms of disease by two main mechanisms: (a) production of toxins, both endotoxin and exotoxin and (b) production of inflammation.

The words “virulence” and “virulent” are derived from the Latin word *virulentus*, meaning “full of poison.” The term *virulentus* is derived from the Latin words *virus* (poison) and *lentus* (fullness), and, in turn, the term *virus* may be related to the Sanskrit word *visham*, meaning “poison.”

**Virulence** is a measure of a microbe’s ability to cause disease. It is a quantitative measure of pathogenicity and is measured by the number of organisms required to cause disease. It means that a highly virulent microbe requires fewer organisms to cause disease than a less virulent one; hence it is directly dependent on the infectious dose of the organism.

The 50% lethal dose ( $LD_{50}$ ) is the number of organisms required to kill half of the hosts, whereas 50% infectious dose ( $ID_{50}$ ) is the number of microbes needed to cause infection in half of the hosts. The infectious dose of an organism required to cause disease varies among the pathogenic bacteria.



TABLE 10-1 Important bacterial surface virulence

Virulence factors	Bacteria
<b>Capsule</b>	
Polysaccharide capsule	<i>Streptococcus pneumoniae</i> <i>Klebsiella pneumoniae</i> <i>Haemophilus influenzae</i> <i>Salmonella Typhi</i> <i>Neisseria meningitidis</i>
Polypeptide capsule	<i>Bacillus anthracis</i>
Pili protein	<i>Escherichia coli</i>
Protein A	<i>Staphylococcus aureus</i>
M protein	<i>Streptococcus pyogenes</i>
V and W proteins	<i>Yersinia pestis</i>

For example, the infectious dose of *Shigella* to cause dysentery is less than 100 organisms, whereas that of *Salmonella* to cause diarrhea is more than 100,000 organisms.

The virulence of a microbe is determined by virulence factors, such as capsules, exotoxins, or endotoxins (Table 10-1).

**Pathogenicity** is the capacity of a pathogen species to cause disease, while virulence is used to describe the sum of disease causing properties of a population (*strain*) within the species. Pathogens can be distinguished from their avirulent counterparts by the presence of specific genes or gene clusters in the genome known as **pathogenicity islands**.

The diseases that can be spread from one person to another are called communicable diseases. Most microbial infections are communicable diseases.

Three epidemiological terms are often used to describe infection: endemic, epidemic, and pandemic:

- **Endemic:** The infection that occurs at a persistent, usually low level in a certain geographical area is called endemic.
- **Epidemic:** The infection that occurs at a much higher rate than usual is known as epidemic.
- **Pandemic:** Infection that spreads rapidly over large areas of the world is known as a pandemic.

## Types of Infections

Infections may be of the following types:

- **Primary infection:** This condition denotes an initial infection with an organism in a host.
- **Reinfection:** This condition denotes subsequent infection with the same organism in the same host.
- **Secondary infection:** This condition denotes an infection with a new organism in a host whose body resistance is already lowered by a pre-existing infectious disease.
- **Cross-infection:** This condition denotes an infection with a new organism from another host or another external source in a patient who is already suffering from a disease.
- **Nosocomial infection:** Cross-infections acquired in hospitals are called hospital-acquired, hospital-associated, or nosocomial infections.

- **Iatrogenic infection:** This condition denotes a physician-induced infection as a result of therapy with drugs or investigation procedures.
- **Subclinical infection:** Inapparent clinical infections are called subclinical infections.
- **Latent infections:** This denotes a condition in which some organisms may remain in a latent or hidden stage in host and subsequently they multiply to produce clinical disease when host resistance is lowered.

## Stages of Pathogenesis of Infections

Infectious diseases are complex. The outcome of infection depends on a variety of factors of the microbe and host as follows:

1. The ability of the organism to break host barriers and to evade destruction by innate local and tissue host defenses.
2. The ability of the organism to replicate, to spread, to establish infection, and to cause disease.
3. The ability of the organism to transmit to a new susceptible host.
4. The innate and adaptive immunologic ability of the host to control and eliminate the invading microorganism.

The infection process involves the following stages: (a) transmission of infection, (b) entry of the organisms and evasion of the local defenses, (c) adherence to cell surfaces, (d) growth and multiplication of the bacteria at the site of adherence, (e) manifestations of disease, and (f) termination of disease.

## Transmission of Infection

There are three important components that play an important role in successful transmission of microbial diseases. These are (a) reservoir, (b) mode of transmission, and (c) susceptible host.

### Reservoir

Reservoirs of microbial infections are human, animal, plant, soil, or inanimate matter in which organisms usually live, multiply, and cause the infections with or without overt clinical manifestations. Humans are usually the common reservoirs of many of the microbial infections. Animals are reservoirs of zoonotic infections, such as plague (e.g., rats), rabies (e.g., dogs), cysticercosis (e.g., pigs), etc.

**Sources of infections:** The sources of infections may be endogenous and exogenous:

- **Endogenous sources:** The source of infection is the normal bacterial flora present in the human body. These bacteria are usually nonpathogenic but in certain situations become pathogenic and cause infections at different sites in the same host. For example, *Escherichia coli* present as normal flora of the intestine may cause urinary tract infection in the same host. Similarly, viridans streptococci present as a part of the normal flora of the mouth may cause infective endocarditis.

■ **Exogenous sources:** The source of infection is from outside the host's body. Most of the microbial infections are exogenous in nature. The exogenous sources include the following:

**1. Humans:** Humans are the most common sources of infections caused by the microorganisms. They may be either patients or carriers. The patient suffering from an active infection is an important source of infection to others.

A carrier is a person who harbors pathogenic microorganisms without showing any signs and symptoms of disease. Carriers are also important sources of infections. A carrier may be (a) healthy carrier, (b) convalescent carrier, (c) temporary carrier, and (d) chronic carrier.

- **Healthy carrier** is the host who harbors the microorganism without ever suffering from the disease caused by that microorganism.
- **Convalescent carrier** is the host who continues to harbor the microorganism even after recovering from the clinical disease caused by the same pathogen.
- **Temporary carrier** is the host who harbors the microorganism up to 6 months after recovering from the disease caused by the same pathogen.
- **Chronic carrier** is the host who harbors the microorganism for many years after recovering from the clinical disease caused by the same pathogen.

**2. Animals:** Animals are also important sources of infection for humans. The symptomatic as well as asymptomatic animals can transmit infections to humans. Asymptomatic animals act as a reservoir of human infections. These are called as **reservoir hosts**. Infections transmitted from animals to humans are called **zoonotic infections**.

The examples of zoonotic infections include bacterial (e.g., plague, anthrax, bovine tuberculosis, etc.), viral (e.g., rabies, Japanese encephalitis, etc.), fungal (e.g., dermatophytic infections), and parasitic (e.g., toxoplasmosis, cysticercosis, hydatid disease, etc.).

**3. Insects:** Insects, such as mosquitoes, ticks, mites, flies, fleas, and lice may transmit a wide variety of microorganisms to the humans (Table 10-2). The diseases transmitted by the insects are collectively referred to as **arthropod-borne diseases** and the insects transmitting these pathogens are called vectors. Insect vectors may transmit the infection in two ways: mechanical transmission and biological transmission.

- **Mechanical vectors:** Insects (e.g., domestic flies) carry enteric bacteria (*Salmonella typhi*, *Shigella* spp., etc.) mechanically on their legs, wings, and surface of the body and transfer them to food.
- **Biological vectors:** These are the vectors in which the microorganisms multiply or undergo a part of their life

TABLE 10-2

Microbial diseases transmitted by insects

Organism	Disease	Reservoir	Insect
<b>Bacteria</b>			
<i>Yersinia pestis</i>	Plague	Rodents, especially rats	Rat fleas
<i>Francisella tularensis</i>	Tularemia	Rabbits and other rodents	Ticks
<i>Borrelia recurrentis</i>	Relapsing fever	Humans	Lice
<i>Borrelia burgdorferi</i>	Lyme disease	Rodents and deer	Ixodes ticks
<i>Rickettsia rickettsii</i>	Rocky mountain spotted fever	Dogs, rodents, and ticks	Ticks
<i>Rickettsia prowazekii</i>	Epidemic typhus	Humans	Lice
<i>Ehrlichia chaffeensis</i>	Ehrlichiosis	Deer and rodents	Ticks
<b>Parasites</b>			
<i>Leishmania</i> spp.	Leishmaniasis	Humans, dogs, and wild canine	Sandfly ( <i>Phlebotomus</i> )
<i>Trypanosoma</i> spp.	Trypanosomiasis	Humans, armadillos, antelope, and cattle	Reduviid bug, tsetse fly
<i>Plasmodium</i> spp.	Malaria	Humans	<i>Anopheles</i> mosquitoes
<i>Wuchereria bancrofti</i> and <i>Brugia malayi</i>	Filaria	Humans	Mosquitoes ( <i>Culex</i> , <i>Aedes</i> , <i>Mansonia</i> spp.)
<b>Viruses</b>			
Japanese encephalitis virus	Japanese encephalitis	Birds	<i>Culex tritaeniorhynchus</i> mosquitoes
West Nile virus	West Nile fever	Birds	<i>Culex</i> mosquitoes
Chikungunya virus	Chikungunya	Humans and monkeys	<i>Aedes aegypti</i> mosquitoes
Dengue virus	Dengue	Humans	<i>Aedes aegypti</i> mosquitoes
Kyasanur forest disease virus	Kyasanur forest disease	Forest birds and small mammals	Tick
Yellow fever virus	Yellow fever	Monkeys and humans	<i>Aedes aegypti</i> mosquitoes

cycle before being transmitted to humans. Rat flea and female *Anopheles* mosquitoes are the examples of biological vectors that transmit plague and malaria, respectively, to humans by biting.

Insects, besides acting as vectors, also act as reservoir hosts (e.g., ticks in relapsing fever).

**4. Food:** Food items contaminated with pathogens also act as source of infection and cause diarrhea, dysentery, food poisoning, and gastroenteritis.

**5. Water:** Water contaminated with microorganisms also acts as a source of infection and transmits water-borne diseases, such as leptospirosis, cholera, dysentery, hepatitis A infection, etc.

## ► Modes of transmission

Microbial pathogens causing various infectious diseases are transmitted from one host to another by many ways: (a) contact, (b) inoculation, (c) ingestion, (d) inhalation, and (e) vectors (Table 10-3).

**1. Contact:** Transmission of microorganisms from person to person occurs by direct or indirect contact. *Transmission by direct contact* occurs through the acts of touching, kissing, sex, etc. Hence, this mode of transmission is also known as person-to-person transmission. The diseases transmitted by direct contact include common cold, staphylococcal infections, and sexually transmitted infections (e.g., gonorrhea, syphilis, and AIDS, etc.). The term contagious disease was used earlier for the disease acquired by direct contact.

Microorganisms can also be *transmitted by indirect contact* through inanimate objects, such as clothings, handkerchief, toys, etc., called **fomites**. The fomites, contaminated by microbial pathogens, act as a vehicle for their transmission. Influenza, tuberculosis, and certain superficial fungal infections are examples of diseases transmitted by fomites.

**TABLE 10-3** Different modes of transmission

Modes of transmission	Disease	Causative agents
<b>Human to human</b>		
Direct contact	Gonorrhea	<i>Neisseria gonorrhoeae</i>
Indirect contact	Dysentery	<i>Shigella dysenteriae</i>
Blood-borne	Syphilis	<i>Treponema pallidum</i>
Transplacental	Congenital syphilis	<i>Treponema pallidum</i>
<b>Nonhuman to human (animal origin)</b>		
Direct contact	Cat-scratch disease	<i>Bartonella henselae</i>
	Lyme disease	<i>Borrelia burgdorferi</i>
Through animal excreta	Hemolytic uremic syndrome	<i>Enterohemorrhagic Escherichia coli</i> (EHEC)
Handling of fomites	Skin infection	<i>Staphylococcus aureus</i>
Soil borne	Tetanus	<i>Clostridium tetani</i>
Water borne	Legionnaire's disease	<i>Legionella pneumophila</i>

**2. Inoculation:** Infections can be transmitted by inoculation of microorganisms directly into tissues of the host. For example, tetanus is transmitted by direct inoculation of *Clostridium tetani* spores present in soil to the injured tissues in the host. These spores then germinate to vegetative forms of bacteria and migrate along the neural tissues to cause tetanus. Similarly, rabid dogs through their act of biting inoculate rabies virus directly to host tissue and cause rabies in humans.

**Iatrogenic infection** occurs following the use of unsterile syringes and equipment in a hospital. Hepatitis B and C and HIV infections are the examples of iatrogenic infections caused by use of contaminated syringes and that of contaminated blood and blood products.

**3. Ingestion:** Ingestion of water and food contaminated with microorganisms can transmit a wide variety of microbial infections. For example, food poisoning caused by *Bacillus cereus* is transmitted by rice contaminated with bacterial spores that survive boiling. If the rice is cooled and reheated, the spores of the bacteria may germinate to the bacteria that produce a heat-stable toxin that induces vomiting. Cholera, typhoid, food poisoning, hepatitis A, poliomyelitis, and many parasitic infections are the other examples of diseases transmitted by ingestion of contaminated food and water.

**4. Inhalation:** Infections are transmitted by inhalation of droplet nuclei that are discharged into the air by coughing, sneezing, or talking. Respiratory pathogens are shed into the environment by patients in secretions from the nose or throat during coughing, sneezing, or talking. Small droplets (less than 0.1 mm in diameter) become airborne as minute particles or droplet nuclei (1–10  $\mu\text{m}$  in diameter), while large droplets fall down to the ground. Infections are transmitted by inhalation of these droplet nuclei containing respiratory pathogen, which remain suspended in air for a long period of time.

Measles, influenza, whooping cough, tuberculosis, aspergillosis, etc. are few examples of infectious diseases acquired by inhalation.

**5. Vectors:** Mosquitoes, flies, fleas, ticks, mite, and lice are the vectors that transmit many diseases as mentioned earlier.

## ► Susceptible host

The infective agent enters the body by four main routes: (a) genital tract, (b) respiratory tract, (c) gastrointestinal tract, and (d) skin. The pathogens can be transmitted either as vertical or horizontal transmission.

**Vertical transmission:** Certain bacteria (*Treponema pallidum*), viruses (rubella and cytomegalovirus), and parasites (*Toxoplasma gondii*) can be transferred from mother to fetus by a process called vertical transmission (Table 10-4). The organisms can be transmitted vertically by three ways:

- Across the placenta,
- Within birth canal during birth, and
- Through breast milk.

TABLE 10-4

## Vertical transmission of microbial agents

Modes of transmission	Organism	Disease
<b>Breast milk</b>		
Bacteria	<i>Staphylococcus aureus</i>	Skin or oral infection
Viruses	Human T-cell leukemia virus	Asymptomatic
	Cytomegalovirus	Asymptomatic
	Human immunodeficiency virus (HIV)	Asymptomatic infection
<b>During passage through birth canal</b>		
Bacteria	Group B streptococcus	Neonatal sepsis and meningitis
	<i>Neisseria gonorrhoeae</i>	Conjunctivitis
	<i>Chlamydia trachomatis</i>	Pneumonia or conjunctivitis
Viruses	HIV	Asymptomatic infection
	Hepatitis B virus	Hepatitis B
	Herpes simplex virus-2	Skin or CNS infection; sepsis
<b>Transplacental</b>		
Bacteria	<i>Listeria monocytogenes</i>	Neonatal sepsis and meningitis
	<i>Treponema pallidum</i>	Congenital syphilis
Viruses	Cytomegalovirus	Congenital abnormalities
	Parvovirus B19	Hydrops fetalis
Parasite	<i>Toxoplasma gondii</i>	Congenital toxoplasmosis

Table 10-4 summarizes a list of diseases transmitted vertically.

**Horizontal transmission:** Unlike vertical transmission, horizontal transmission occurs from person to person and is not from mother to offspring (Fig. 10-1).

## Entry of Organisms and Evasion of Local Defenses

Skin, mucus, ciliated epithelium, and secretions containing antibacterial substances (e.g., lysozyme) are the natural barriers of the human and animal hosts that prevent microbial entry. However, these barriers are sometimes broken (e.g., a break in the skin, an ulcer in the intestine, or a tumor, etc.), thereby allowing the entry of microbes into the host (Table 10-5). On entry, the microbes spread through blood circulation to other sites in the body (Fig. 10-2).

**Skin:** The stratified squamous epithelium of the skin with its superficial cornified anucleate layers is a simple and efficient mechanical barrier to prevent microbial invasion. Organisms gain access to the underlying tissues only by breaks or by way of hair follicles, sebaceous glands, and sweat glands that traverse the stratified layers.

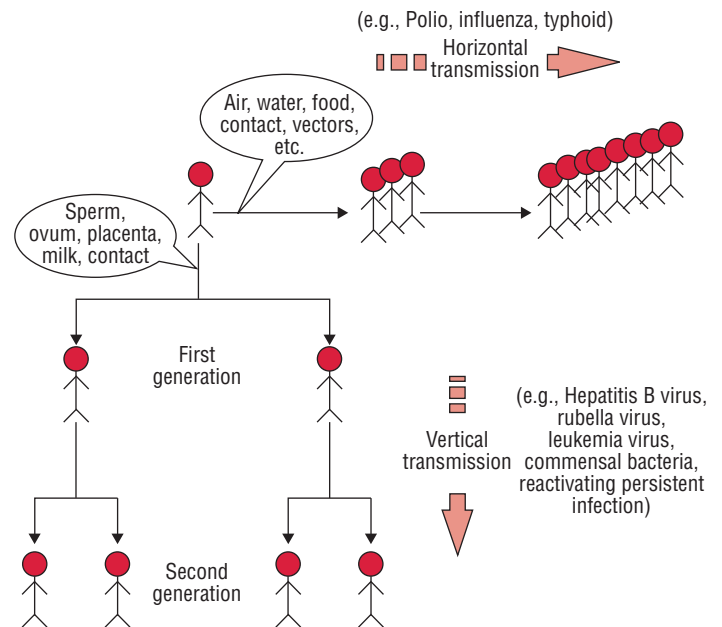

FIG. 10-1. Schematic diagram showing horizontal and vertical transmission of infections.

The surface of the skin continuously desquamates and thereby tends to shed contaminating organisms. The skin also inhibits the growth of most extraneous microorganisms due to its low moisture, low pH, and the presence of substances with an antibacterial activity.

**Mucus:** Viscous mucus secreted by goblet cells protects the epithelium lining the respiratory and gastrointestinal tracts and urogenital system. Microorganisms become trapped in the mucus layer and may be swept away before they reach the epithelial cell surface. Secretory IgA, secreted into the mucus, and other secreted antimicrobials (such as lysozyme and lactoferrin) facilitate this cleansing process.

**Ciliated epithelial cells:** These cells constantly move the mucus away from the epithelial surfaces. For example, mucus in the respiratory tract—particles larger than 5  $\mu\text{m}$  are washed and trapped in the mucus. Similarly, the multilayered transitional epithelium of the urinary tract uses the flushing effect of urine, and its relatively low pH acts as an additional defense mechanism to limit microbial entry and growth.

**Secretions:** The high level of hydrochloric acid and gastric enzymes in the normal stomach kills many ingested bacteria. Others are susceptible to pancreatic digestive enzymes or to the detergent effect of bile salts.

## Adherence to Cell Surfaces

Adherence of bacteria to body surface is the most important event in the pathogenesis of disease. Once bacteria enter the body of the host, they must adhere to the cells of a tissue surface. If they do not adhere, they will be swept away by mucus and other fluids that bathe the tissue surface.

**TABLE 10-5** Routes of entry of microbial pathogens

Portal of entry	Bacteria	Virus	Fungi
Skin and mucus membrane	<i>Clostridium tetani</i> , <i>Leptospira</i>	Hepatitis B virus (HBV), human immunodeficiency virus (HIV)	Dermatophytes
Respiratory tract	<i>Streptococcus pneumoniae</i> , <i>Neisseria meningitidis</i> , <i>Haemophilus influenzae</i> , <i>Mycobacterium tuberculosis</i>	Rhinovirus, RSV (respiratory syncytial virus), Epstein-Barr virus, influenza virus	<i>Cryptococcus neoformans</i> , <i>Histoplasma capsulatum</i> , <i>Pneumocystis jirovecii</i>
Gastrointestinal tract	<i>Shigella</i> spp., <i>Salmonella</i> spp., <i>Vibrio</i> spp.	Hepatitis A or E virus, poliovirus	<i>Candida albicans</i>
Genital tract	<i>Neisseria gonorrhoeae</i> , <i>Treponema pallidum</i>	HIV, human papilloma virus	<i>Candida albicans</i>

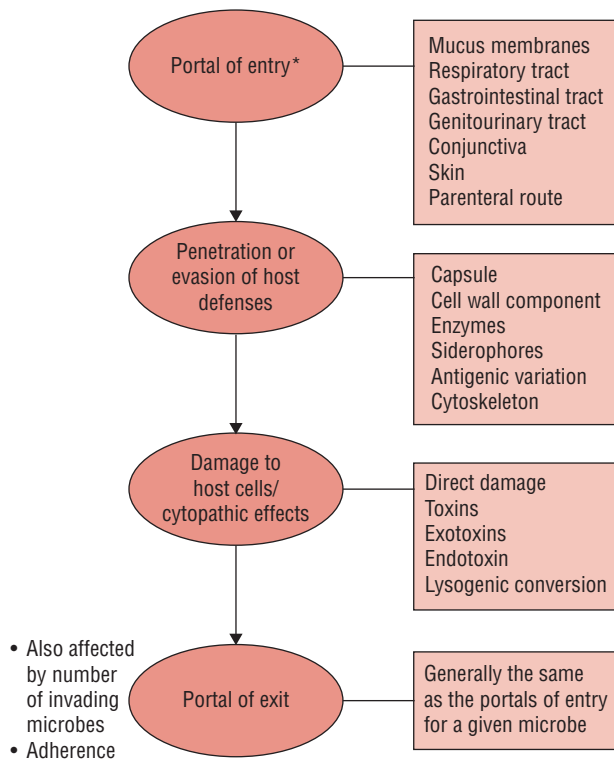

**FIG. 10-2.** Schematic diagram showing various stages of infection process.

Most pathogenic microorganisms have more than a single mechanism of host cell attachment. Adherence is important not only during the initial encounter between the pathogen and its host but also throughout the infection cycle. Adherence requires participation of two factors: bacterial adhesins and a receptor on the host cell.

**Bacterial adhesins**

Bacterial adherence to the cell surface is mediated by specialized molecules. The various molecules that mediate adherence to the cell surface are called **adhesins**. These adhesins allow the bacteria to adhere to the surface of human cell, thereby promoting their ability to cause disease. Microorganisms that lack this mechanism are nonpathogenic. Bacterial adhesins can be divided into two major groups: pili (fimbriae) and nonpilus adhesins (afimbrial adhesins).

**Pili:** These are the main mechanisms by which bacteria adhere to human cells. They are the fibers that extend from the bacterial surfaces and mediate attachment of bacteria to specific receptor on the host cells. The pili of many Gram-negative bacteria bind directly to sugar residues that are part of glycolipids or glycoproteins on the host cells. They also act as a protein scaffold to which another more specific adhesive protein is affixed.

**Key Points**

- Most *E. coli* strains that cause pyogenic nephritis produce an adhesin protein known as P-pili (pyelonephritis-associated pili) encoded by *pap* genes. Many of these adhesin proteins are present at the tip of the pili that bind specific receptors on the surface of the urinary bladder. The binding prevents the bacteria from being washed away from the urinary bladder by the flushing action of the urine.
- Similarly, the pili of *Neisseria gonorrhoeae* mediate the attachment of the organism by binding to oligosaccharide receptors on epithelial cells of the urethra. The gonococci use pili as primary adhesins and *opacity-associated proteins (Opa)* as secondary adhesins to host cells. Certain Opa proteins mediate adherence to polymorphonuclear cells. Some gonococci survive after phagocytosis by these cells. In uterine (fallopian) tube organ cultures, the gonococci adhere to the microvilli of nonciliated cells and appear to induce engulfment by these cells. The gonococci multiply intracellularly and migrate to the subepithelial space by an unknown mechanism.

The pili of the Gram-negative bacteria have been classified into five different types and are extremely important in the pathogenesis of infections caused by them. Further antigenic variation in the actual structural pilin protein can be an important source of antigenic diversity for the pathogen.

- **Nonpilus adhesins:** These include glycocalyx and other adhesins present on the bacterial surfaces. Glycocalyx is a polysaccharide “slime layer” secreted by some strains of bacteria that mediates strong adherence to certain structures, such as catheters, prosthetic implants, and heart valves. For example, the glycocalyx of *Staphylococcus epidermidis* and that of certain viridans streptococci allows the bacteria to adhere strongly to the endothelium of the heart valve. The matrix formed by these adhesins forming proteins is called a **biofilm**.

The biofilms are important in pathogenesis because they protect the bacteria by host defense and antibiotics.

The biofilms facilitate colonization of bacteria, especially of surgical appliances, such as artificial valve or indwelling catheters.

- *Streptococcus pyogenes* makes use of nonpilus adhesins (such as lipoteichoic acid, protein F, and M protein) to bind to epithelial cells. The lipoteichoic acid and protein F cause adherence of the streptococci to buccal epithelial cells. M protein acts as an antiphagocytic molecule.
- Recently, it has been shown that certain strains of *E. coli* and *Shigella* spp. have surface proteins called **curli**, which help in the binding of bacteria to the host endothelium as well as to extracellular proteins.

### ► Receptor on the host cell

Certain receptors are present on the host cells to which pathogens adhere and initiate infections. For example, many adhesion proteins are present at the tip of the pili of *E. coli*. These bind specific receptors on the surface of the urinary bladder to initiate urinary tract infections. Similarly, the gonococci adhere to the microvilli of nonciliated cells and start disease process.

## Growth and Multiplication of Bacteria at the Site of Adherence

Bacteria cause diseases by three main mechanisms: (a) invasion of tissues followed by inflammation, (b) toxin production, and (c) immunopathogenesis. Table 10-6 summarizes a list of bacteria with their virulence factors.

### ► Invasion of tissues followed by inflammation

Invasiveness refers to the ability of an organism to invade the host cells after establishing infection. “Invasion” is the term commonly used to describe the entry of bacteria into host cells, implying an active role for the organisms and a passive

role for the host cells. For many disease-causing bacteria, invasion of the host’s epithelium is central to the infectious process. Some bacteria (e.g., *Salmonella* spp.) invade tissues through the intracellular junctions in the cytoplasm. Some bacteria (e.g., *Shigella* spp.) multiply within host cells, whereas other bacteria do not.

*Shigella* spp. initiate infection process by adhering to host cells in the small intestine. There are multiple proteins, including the *invasion plasmid antigens* (IpA-D), that contribute to the process. Once inside the cells, the shigellae either are lysed or escape from the phagocytic vesicle, where they multiply in the cytoplasm.

Other bacteria (e.g., *Yersinia* species, *N. gonorrhoeae*, *Chlamydia trachomatis*) invade specific types of the host’s epithelial cells and may subsequently enter the tissue. Once inside the host cell, the bacteria may remain enclosed in a vacuole composed of the host cell membrane, or the vacuole membrane may dissolved and bacteria may disperse within the cell and from one cell to another.

Invasion of tissues followed by inflammation is enhanced by many factors, which include: (a) enzymes, (b) antiphagocytic factors, (c) biofilms, (d) inflammation, and (e) intracellular survival.

1. **Enzymes:** Invasion of bacteria is enhanced by many enzymes. Many species of bacteria produce enzymes that are not intrinsically toxic but do play important roles in the infectious process. Some of these enzymes are discussed below:

- **Hyaluronidases and collagenase:** Hyaluronidases and collagenase are the enzymes that hydrolyze hyaluronic acid and degrade collagen, respectively; thereby allowing the bacteria to spread through subcutaneous tissues.

Hyaluronidases are produced by many bacteria (e.g., staphylococci, streptococci, and anaerobes) and aid in their spread through tissues. For example, hyaluronidase produced by *S. pyogenes* degrades hyaluronic acid in the subcutaneous tissue, thereby facilitating the organism to spread rapidly.

*Clostridium perfringens* produces the proteolytic enzyme collagenase, which degrades collagen (the major protein of fibrous connective tissue), and promotes the spread of infection in tissue.

- **Coagulase:** *Staphylococcus aureus* produces the enzyme coagulase, which in association with blood factors coagulates the plasma. Coagulase contributes to the formation of fibrin walls around staphylococcal lesions, which protects bacteria from phagocytosis by walling off the infected area. The enzyme also causes deposition of fibrin on the surfaces of individual staphylococci, which may help protect them from phagocytosis or from destruction within phagocytic cells.
- **Streptokinase (fibrinolysin):** Many hemolytic streptococci produce enzyme streptokinase, which activates a proteolytic enzyme of plasma. This enzyme is then able to dissolve coagulated plasma and thereby possibly aids in the rapid spread of streptococci through tissues. Streptokinase has been used in the treatment of acute myocardial infarction to dissolve fibrin clots.

TABLE 10-6

Bacterial virulence factors

Organism	Virulence factors
<i>Staphylococcus aureus</i>	Coagulase, protein A
<i>Streptococcus pyogenes</i>	M protein
<i>Streptococcus pneumoniae</i>	Capsular polysaccharide
<i>Enterococcus faecalis</i>	Cytolysin, biofilm formation
<i>Neisseria gonorrhoeae</i>	Pili, opacity-associated proteins (Opa), IgA proteases
<i>Neisseria meningitidis</i>	Capsular polysaccharide
<i>Bacillus anthracis</i>	Capsule, edema factor, lethal factor, protective antigen
<i>Listeria monocytogenes</i>	Internalin
<i>Escherichia coli</i>	Heat-labile and heat-stable enterotoxins, pili
<i>Haemophilus influenzae</i>	Capsular polysaccharide
<i>Vibrio cholerae</i>	Cholera toxin
<i>Mycobacterium tuberculosis</i>	Mycolic acid cell wall

- **IgA1 proteases:** Certain pathogenic bacteria produce enzymes IgA1 proteases that split IgA1 at specific proline–threonine or proline–serine bonds in the hinge region and inactivate its antibody activity. IgA1 protease is an important virulence factor of the pathogens, such as *N. gonorrhoeae*, *Neisseria meningitidis*, *Haemophilus influenzae*, and *Streptococcus pneumoniae*. Production of IgA1 protease allows the pathogens to inactivate the primary antibody found on mucosal surfaces and thereby facilitates the attachment of these bacteria to the mucous membrane.
2. **Antiphagocytic factors:** Many bacterial pathogens are rapidly killed once they are ingested by polymorphonuclear cells or macrophages. Some pathogens evade phagocytosis or leukocyte microbicidal mechanisms by several antiphagocytic factors; the most important being (a) capsule, (b) cell wall proteins, (c) cytotoxins, and (d) surface antigens.
- **Capsule:** The capsule surrounding bacteria, such as *S. pneumoniae* (Fig. 10-3) and *N. meningitidis*, is the most important antiphagocytic factor. It retards the phagocytosis of bacteria by preventing the phagocytes from adhering to the bacteria.
  - **Cell wall proteins:** The cell wall proteins, such as the protein A and protein M, of *S. aureus* and *S. pyogenes* especially are antiphagocytic. For example, protein A of *S. aureus* binds to IgG and prevents the activation of complement. M protein of *S. pyogenes* is antiphagocytic.
  - **Cytotoxins:** Certain bacteria produce cytotoxins that interfere with chemotaxis or killing of phagocytes. For example, *S. aureus* produces hemolysins and leukocidins that lyse and damage RBCs and WBCs.
  - **Surface antigens:** Surface antigens of bacteria, such as Vi antigen of *S. typhi* and K antigen of *E. coli* make the bacteria resistant to phagocytosis and lytic activity of complement.
- A list of intracellular pathogens is given in Table 10-7.

3. **Biofilms:** The biofilm is an aggregate of interactive bacteria attached to a solid surface or to each other and encased in an exopolysaccharide matrix. Biofilms consist of single cells and microcolonies of bacteria, all found together in a highly hydrated, predominantly anionic exopolymer matrix. This is distinct from planktonic or free-living bacterial growth, in which interactions of the microorganisms do not occur. Biofilms form a slimy coat on solid surfaces and occur throughout the nature. A single species of bacteria may be involved, or more than one species may coaggregate to form a biofilm. Fungi, including yeasts, are occasionally involved.

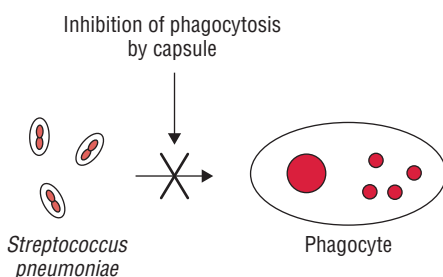

TABLE 10-7

## Intracellular pathogens

Organism	Examples
Bacteria	<i>Mycobacterium</i> spp. <i>Listeria monocytogenes</i> <i>Brucella</i> spp. <i>Legionella pneumophila</i> <i>Francisella</i> spp. <i>Yersinia pestis</i> <i>Salmonella</i> Typhi <i>Shigella dysenteriae</i> Rickettsia Chlamydia
Viruses	All viruses
Parasites	<i>Leishmania</i> spp. <i>Trypanosoma cruzi</i> <i>Plasmodium</i> spp. <i>Babesia</i> spp. <i>Toxoplasma gondii</i> <i>Cryptosporidium parvum</i> <i>Microsporidium</i> spp.
Fungus	<i>Histoplasma capsulatum</i>

Biofilms are important in human infections that are persistent and difficult to treat. A few such infections include:

- (a) *S. epidermidis* and *S. aureus* infections of central venous catheters;
- (b) Eye infections that occur with contact lenses and intraocular lenses;
- (c) Infections in dental plaque; and
- (d) *Pseudomonas aeruginosa* airway infections in cystic fibrosis patients.

## Key Points

Biofilm confers an inherent resistance to antimicrobial agents, whether these antimicrobial agents are antibiotics, disinfectants, or germicides. The mechanisms of resistance are:

- Delayed penetration of antimicrobial agent through the biofilm matrix;
- Altered growth rate of biofilm organisms; and
- Other physiological changes due to biofilm mode of growth.

4. **Inflammation:** Inflammation is an important host defense induced by the presence of bacteria in the body. It is of two types: pyogenic and granulomatous. **Pyogenic inflammation** is the host defense seen primarily against pyogenic or pus-producing bacteria, such as *S. pyogenes*. It typically consists of neutrophils and the production of specific antibodies and elevated level of complement. **Granulomatous inflammation** is the host defense seen primarily against intracellular granuloma-producing bacteria, such as *Mycobacterium tuberculosis*, *Mycobacterium leprae*, etc. The response consists of production of macrophages and CD4+ T cells.

FIG. 10-3. Schematic diagram showing inhibition of phagocytosis by the capsule of *Streptococcus pneumoniae*.

**5. Intracellular survival:** A few mechanisms that are suggested for intracellular survival of bacteria include (a) inhibition of phagolysosome fusion, (b) resistance to action of lysosomal enzymes, and (c) adaptation to cytoplasmic replication as follows:

- Bacteria (such as *Chlamydia*, *M. tuberculosis*) that interfere with the formation of phagolysosomes in a phagocyte can survive intracellularly and evade host defense process. These bacteria live within cells and are protected from attack by macrophages and neutrophils. The bacteria that do not interfere with the formation of phagolysosomes are otherwise killed inside the phagocytes.
- Presence of capsular polysaccharide in *Mycobacterium lepraemurium* and mycoside in *M. tuberculosis* makes these bacteria resistant to action of lysosomal enzymes.
- Certain bacteria, such as rickettsiae, escape from the phagosome into the cytoplasm of the host cell before the fusion of phagosome with lysosome takes place and hence continue to remain intracellular.

## ► Toxin production

Toxins produced by bacteria are generally classified into two groups: exotoxins and endotoxins.

- 1. Exotoxins:** Exotoxins are heat-labile proteins that are produced by several Gram-positive and Gram-negative bacteria. These are bacterial products, which are secreted into tissues and directly harm tissues or trigger destructive biological activities (Fig. 10-4). The genes coding for these proteins are frequently encoded on plasmid or on bacteriophage DNA. Some important toxins encoded by plasmids are tetanus toxin of *C. tetani* and heat-labile and heat-stable toxins of enterotoxigenic *E. coli*. Toxins encoded by bacteriophage DNA are cholera toxins, diphtheria toxins, and botulinum toxin.

### Key Points

Exotoxins show the following features:

- Exotoxins are good antigens; they induce the synthesis of protective antibody called antitoxins. Some of these antitoxins are useful in the treatment of botulism, tetanus, and other diseases. Exotoxins treated with formaldehyde or acid or heat can be converted into toxoid. The toxoids lack toxicity but retain antigenicity. Hence, these are used in protective vaccines.
- Exotoxins are some of the most toxic substances known. They are highly potent even in minute amounts. Botulinum toxin is the most potent one, and it has been estimated that 3 kg of botulinum toxin can kill all persons in the world. Similarly, the fatal dose of tetanus toxin for a human is estimated to be less than 1  $\mu$ g.
- Many toxins have a dimeric A-B subunit structure. Diphtheria toxin, tetanus toxin, cholera toxins, and the enterotoxin of *E. coli* are some of the examples of exotoxins that have an A-B subunit structure. A is the active subunit that possesses the toxic activity, and B is the binding subunit that is responsible for the binding of exotoxin to specific receptors of the membrane of human cell (Fig. 10-5).
- These toxins are very specific in their mechanism of action and act at specific sites of a tissue. The biochemical targets

of A-B toxin include ribosomes, transport mechanisms, and intracellular signaling (cyclic adenosine monophosphate, CAMP; G protein production); all these cause diarrhea, loss of neuronal functions, or even death.

- The exotoxins have specific pharmacological activities and do not produce fever, unlike endotoxins.

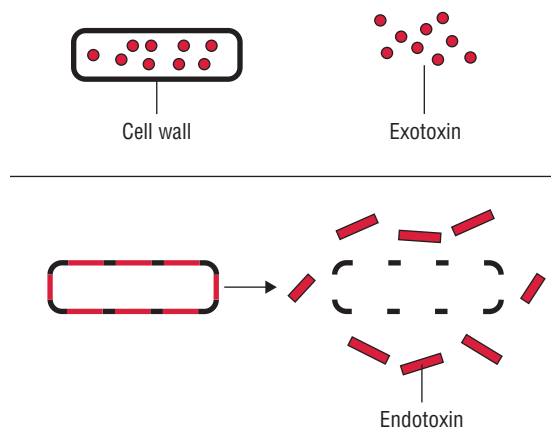

**FIG. 10-4.** Schematic diagram showing release of exotoxin and endotoxin.

**Superantigens:** Superantigens are a special group of toxins. These molecules activate T-cells nonspecifically by binding simultaneously to a T-cell receptor and major histocompatibility complex class II (MHC II) molecules on another cell, without requiring antigen. Nonspecific activation of T cells results in a life-threatening autoimmune-like response by producing a large amount of interleukins, such as IL-1 and IL-2. Furthermore, stimulation of T cells by superantigen can also lead to the death of activated T cells, resulting in loss of specific T-cell clones and that of their immune response. Staphylococcal enterotoxin (toxic shock syndrome toxin) of *S. aureus* and erythrogenic toxin of type A or C of *S. pyogenes* are examples of superantigens.

- 2. Endotoxins:** The term endotoxin was coined in 1893 by Pfeiffer to distinguish the class of toxic substances released after lysis of bacteria from the toxic substances (exotoxins) secreted by bacteria.

### Key Points

Endotoxins show the following properties:

- They are produced by Gram-negative bacteria, but not by Gram-positive bacteria.
- They are lipopolysaccharide (LPS) components of the outer membrane of Gram-negative bacteria. These form an integral part of the cell wall unlike exotoxins, which are actively released from the cells.
- The genes that encode the enzymes that produce the LPS are present on the bacterial chromosome, but not on plasmids or bacteriophage DNA, which usually encodes the exotoxins.
- They are heat stable, and they are released from the bacterial cell surface by disintegration of the cell wall.
- They are weakly antigenic and do not induce, or poorly induce, protective antibodies. Hence, their action is not neutralized by the protective antibodies.
- They cannot be toxoided.



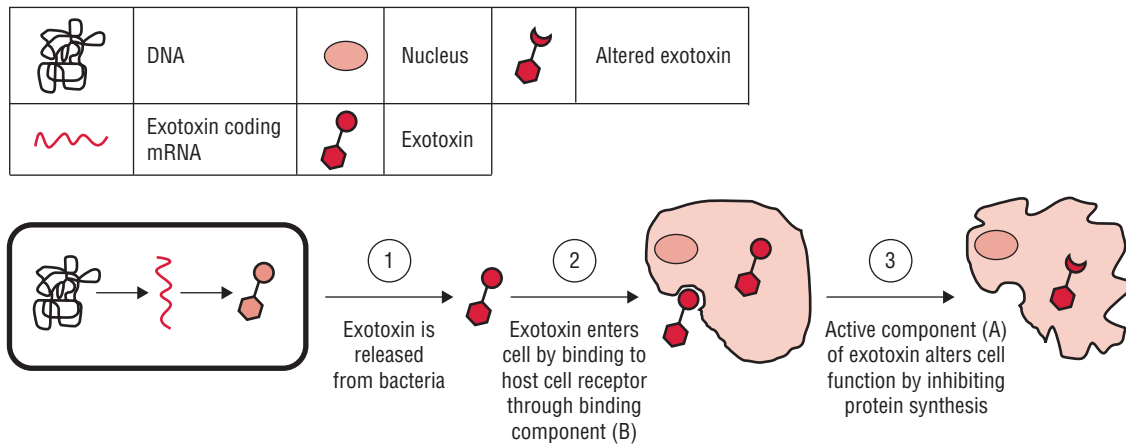

FIG. 10-5. Schematic diagram showing mode of action of exotoxin.

TABLE 10-8

**Mechanisms of endotoxin-mediated toxicity**

Clinical features	Mechanism
Fever	Interleukin-1
Inflammation	Activation of alternative pathway of complement (C3a, C5a)
Disseminated intravascular coagulation (DIC)	Activation of Hageman factor
Shock (hypotension)	Bradykinin, nitric oxide
Leukopenia, thrombocytopenia, decreased peripheral circulation, and perfusion to organs	Secondary to DIC

**Biological activity of endotoxin:** Gram-negative bacteria produce endotoxin during infection. The toxicity of endotoxin is low in comparison with exotoxins. All endotoxins usually produce the same generalized effect of fever and shock. The lipid A protein of LPS is responsible for endotoxin activities (Table 10-8). The endotoxin binds to specific receptors, such as CD14 and TLR4, present on macrophages, B cells, and other cells. Endotoxin exerts profound biological effects on the host and may be lethal. Biological activities of the endotoxins include the following:

- Mitogenic effects on B lymphocytes that increase resistance to viral and bacterial infections.
- Production of gamma interferon by T lymphocytes, which may enhance the antiviral state, promote the rejection of tumor cells, and activates the macrophages and natural killer cells.
- Activation of the complement cascade with the formation of C3a and C5a.
- Production and release of acute-phase cytokines, such as IL-1, TNF- $\alpha$  (tumor necrosis factor-alpha), IL-6, and prostaglandins.

**Endotoxic shock:** Endotoxins at low concentration induce a protective response, such as fever, vasodilation, and

activation of immunity and inflammatory response. However, endotoxins at very high concentration, as seen in blood of patients with Gram-negative bacterial sepsis, cause a syndrome of endotoxic shock. Endotoxic shock is characterized by fever, leukopenia, thrombocytopenia, sudden fall of blood pressure, circulatory collapse, and sudden death. This is because high concentration of endotoxin can activate the alternative pathway of complement and cause vasodilatation and capillary leakage, resulting in high fever, hypertension, and shock. It also causes activation of blood coagulation pathway, leading to disseminated intravascular coagulation. Endotoxins are not destroyed by autoclaving; hence infusion of sterile solution containing endotoxins can cause serious illness.

**Detection of endotoxins in medical solutions:** Endotoxins are omnipresent in the environment. Solutions for human use (such as intravenous fluids) are prepared under carefully controlled conditions to ensure sterility and to remove endotoxin. Representative samples of every manufacturing batch are checked for endotoxins by one of two procedures: (a) limulus lysate test or (b) rabbit pyrogenicity test.

- **Limulus lysate test:** The test depends on the ability of endotoxin to induce gelation of lysates of amoebocyte cells from the horseshoe crab *Limulus polyphemus*. Test kits are commercially available. It is simple, fast, and sensitive to detect endotoxin at a level of 1 ng/mL.
- **Rabbit pyrogenicity test:** The test depends on the exquisite sensitivity of rabbits to the pyrogenic effects of endotoxin. In this test, a sample of the solution to be tested is injected intravenously into the ear veins of adult rabbits, while the rectal temperature of the animal is monitored. Careful monitoring of the temperature responses provides a sensitive and reliable indicator of the presence of endotoxin in the solution.

Table 10-9 summarizes differences between exotoxins and endotoxins.

TABLE 10-9

Differences between endotoxins and exotoxins

Feature	Endotoxin	Exotoxin
Nature	Lipopolysaccharide	Protein (polypeptide)
Source	Gram-negative bacterial cell wall	Gram-positive bacteria and some Gram-negative bacteria
Location of genes	Chromosome	Plasmid or bacteriophage
Nature of secretion	Not secreted by the bacterial cell	Actively secreted by the bacteria
Release of toxin	Cell lysis	Filtration of bacterial cultures
Heat stability	Highly stable (withstand even 100°C for an hour)	Heat-labile, destroyed mostly at 60°C
Mode of action	Mediated by interleukins (IL-1) and tumor necrosis factor	Mostly enzyme-like action
Effect	Nonspecific (fever, shock, etc.)	Specific pharmacological effect
Tissue affinity	No	Specific affinity for certain tissues
Diseases	Gram-negative bacterial sepsis, meningococemia	Botulism, diphtheria, and staphylococcal toxic shock syndrome
Fatal dose	Only large doses are fatal	Small doses (even a few micrograms) are fatal
Antigenicity	Poorly antigenic	Highly antigenic
Neutralization by antibodies	Ineffective	Neutralized by specific antibodies
Vaccine	No effective vaccine	Specific toxoids are available

### ► Immunopathogenesis

In certain diseases, the symptoms are caused not by the organism itself, but due to immune response to the presence of organisms. For example, immune complexes deposited in the glomerulus of the kidney cause poststreptococcal glomerulonephritis. Antibodies that are produced against the M proteins of *S. pyogenes* cross-react with joint, heart, and brain tissues producing disease manifestations of rheumatic fever.

Similarly, the host immune response is an important cause of disease symptoms in patients suffering from syphilis caused by *T. pallidum*, Lyme disease caused by *Borrelia*, and other diseases.

### Manifestations of Disease

Diseases caused by various pathogenic as well as opportunistic pathogens cause a variety of clinical manifestations in infected human hosts. Many of these manifestations are caused either due to the inflammation or toxin production by the bacteria.

### Termination of Disease

Termination of an infectious disease may occur by resolution or continuation of the disease. This depends on a complex

interaction of host immunity with pathogens and host response to treatment with specific antimicrobial agents.

### Stages of an Infectious Disease

There are four discrete stages of an infectious disease, which are as follows:

- 1. Incubation period:** This denotes the time interval between the entry of infective agent and the onset of clinical manifestations of disease. During this period, the infective agent after reaching the selective tissue undergoes multiplication.
- 2. Prodrome period:** It is the time during which only non-specific symptoms of disease occur.
- 3. Specific illness period:** The time during which the characteristic features of disease occur.
- 4. Recovery period:** The time during which symptoms resolve and health is restored.

Not all the cases that recover become free of organism. Some become chronic carriers and act as sources of infection for others. Though some cases may not develop infection, they can act as a link in the transmission of infection. This is called *subclinical infection*.

"This page intentionally left blank"

"This page intentionally left blank"

# Immunity

## Introduction

The term immunity is derived from the Latin word “*immunis*” (exempt), which was originally referred to the protection from legal prosecution offered to the Roman senators during their tenures in office. This term was adopted subsequently to designate the naturally acquired protection against diseases, such as measles or smallpox. It indicated that an individual can develop lifelong resistance to a certain disease after having contracted it only once. The cells and molecules responsible for immunity constitute the *immune system*, and their collective and coordinated response to foreign substances is called the *immune response*.

The concept of immunity has existed since the ancient times. An example is the Chinese custom of making children resistant to smallpox by making them inhale powders made from the skin lesions of patients recovering from the disease. The first European mention of immunity is recorded by Thucydides in Athens during the fifth century BC. In describing plague in Athens, he wrote in 430 BC that only those who had recovered from plague could nurse the sick, because they would not contract the disease a second time.

Once the concept of existence of immunity was established, it was not long before manipulation of immunity under controlled conditions followed. First, it was Edward Jenner who in a successful experiment injected the material from a cowpox pustule into the arm of an 8-year-old boy and demonstrated the lack of development of disease after subsequent exposure to smallpox. This was based on his observations that milkmaids who had suffered from cowpox never contracted the more serious smallpox. Jenner’s technique of inoculating with cowpox to protect against smallpox spread quickly throughout Europe. However, for many reasons, including lack of knowledge of obvious disease targets and their causes, it was after nearly hundred years that this technique was applied to prevent smallpox.

The experimental work of Emil von Behring and Shibasaburo Kitasato in 1890 gave the first insights into the mechanism of immunity, earning von Behring the Nobel Prize in Medicine in 1901. Von Behring and Kitasato demonstrated that serum (the liquid, noncellular component of coagulated blood) from animals previously immunized to diphtheria could transfer the immune state to unimmunized animals. Since then,

immunology as a field of study has come a long way. It has been and remains one of the hottest fields of research as shown by the statistic that about 17 Nobel Prizes have been awarded to scientists involved in immunological research.

## Types of Immunity

The main function of the immune system is to prevent or limit infections by pathogenic microorganisms, such as bacteria, viruses, parasites, and fungi. The recognition of microorganisms and foreign substances is the first event in immune responses of a host. The body’s defense mechanisms can be divided into: (a) innate (natural) immunity and (b) acquired (adaptive) immunity.

### Innate Immunity

Innate immunity is the resistance that an individual possesses by birth. Innate immunity may be classified as (a) individual immunity, (b) racial immunity, and (c) species immunity.

**Individual immunity:** Individual immunity denotes resistance to infection, which varies within different individuals in the same race and species and is genetically determined. For example, if one homozygous twin develops tuberculosis, there is a very high possibility that the other twin will also develop tuberculosis. But in heterozygous twins, there is a very low possibility of the other twin suffering from tuberculosis.

**Racial immunity:** Racial immunity denotes a difference in susceptibility or resistance to infection among different races within a same species. For example, races with sickle cell anemia prevalent in Mediterranean coast are immune to infection caused by malaria parasite *Plasmodium falciparum*. This is due to a genetic abnormality of erythrocytes, resulting in sickle-shaped erythrocytes that prevent parasitization by *P. falciparum*. Similarly, individuals with a hereditary deficiency of glucose-6-phosphatase dehydrogenase are also less susceptible to infection by *P. falciparum*.

**Species immunity:** Species immunity denotes a total or relative resistance to a pathogen shown by all members of a particular species. For example, chickens are resistant to *Bacillus anthracis*, rats are resistant to *Corynebacterium diphtheriae*, whereas humans are susceptible to these bacteria. The exact reason for such type of immunity is not known.

## Key Points

Innate immunity shows the following features:

- It is due to the genetic and constitutional makeup of an individual. Prior contact with microorganisms or their products is not essential.
- It acts as the first line of defense of the host immune system.
- The mechanisms involved in innate immunity are present in place even before exposure to the foreign agent. They are not specific to any infectious agent and do not seem to improve response on repeated exposures.
- Phagocytic cells (e.g., macrophages and neutrophils), barriers (e.g., skin and mucous membrane), and a variety of antimicrobial compounds synthesized by the host, all play important roles in innate immunity.

### ► Factors influencing innate immunity

The factors that may influence innate immunity of the host include age and nutritional status of the host.

**Age:** Extremes of age make an individual highly susceptible to various infections. This is explained in part by the immature immune system in very young children and waning immunity in older individuals. The fetus-in-utero is usually protected from maternal infections by the placental barrier. However, human immunodeficiency virus (HIV), rubella virus, cytomegalovirus, and *Toxoplasma gondii* cross the placental barrier and cause congenital infections.

Very old people are susceptible to suffer more than young people from a disease (e.g., pneumonia) and have high mortality. Measles, mumps, poliomyelitis, and chicken pox are few examples of the diseases that cause more severe clinical illness in adults than in young children. This may be due to more active immune response in an adult causing greater tissue damage.

**Nutritional status:** Nutritional status of the host plays an important role in innate immunity. Both humoral and cell-mediated immunities are lowered in malnutrition. Examples are:

- Neutrophil activity is reduced, interferon response is decreased, and C3 and factor B of the complement are decreased in protein-calorie malnutrition.
- Deficiency of vitamin A, vitamin C, and folic acid makes an individual highly susceptible to infection by many microbial pathogens.

**Hormonal levels:** Individuals with certain hormonal disorders become increasingly susceptible to infection. For example, individuals suffering from diabetes mellitus, hypothyroidism, and adrenal dysfunction are increasingly susceptible to staphylococcal infection, streptococcal infection, candidiasis, aspergillosis, zygomycosis and many other microbial infections. Similarly, pregnant women are more susceptible to many infections due to higher level of steroid during pregnancy.

### ► Mechanisms of innate immunity

Innate immunity of the host performs two most important functions: it kills invading microbes and it activates acquired (adaptive) immune processes. Innate immunity unlike

adaptive immunity, however, does not have any memory and does not improve after re-exposure to the same microorganism. The innate immunity is primarily dependent on four types of defensive barriers: (a) anatomic barriers, (b) physiologic barriers, (c) phagocytosis, and (d) inflammatory responses.

**Anatomic barriers:** Anatomic barriers include skin and mucous membrane. They are the most important components of innate immunity. They act as mechanical barriers and prevent entry of microorganisms into the body. The intact skin prevents entry of microorganisms. For example, breaks in the skin due to scratches, wounds, or abrasion cause infection. Bites of insects harboring pathogenic organisms (e.g., mosquitoes, mites, ticks, fleas, and sandflies), introduce the pathogens into the body and transmit the infection. Skin secretes sebum, which prevents growth of many microorganisms. The sebum consists of lactic acid and fatty acids that maintain the pH of skin between 3 and 5, and this pH inhibits the growth of most microorganisms.

Mucous membranes form a large part of outer covering of gastrointestinal, respiratory, genitourinary, and many other tracts of human host. A number of nonspecific defense mechanisms act to prevent entry of microorganisms through mucous membrane.

- Saliva, tears, and mucous secretions tend to wash away potential invading microorganisms, thereby preventing their attachment to the initial site of infections. These secretions also contain antibacterial or antiviral substances that kill these pathogens.
- Mucus is a viscous fluid secreted by the epithelial cells of mucous membranes that entraps invading microorganisms.
- In lower respiratory tract, mucous membrane is covered by cilia, the hair-like protrusions of the epithelial cell membranes. The synchronous movement of cilia propels mucus-entrapped microorganisms from these tracts.
- In addition, nonpathogenic organisms tend to colonize the epithelial cells of mucosal surfaces. These normal flora generally compete with pathogens for attachment sites on the epithelial cell surface and for necessary nutrients.

**Physiologic barriers:** The physiologic barriers that contribute to innate immunity include the following:

- Gastric acidity is an innate physiologic barrier to infection because very few ingested microorganisms can survive the low pH of stomach contents.
- Lysozyme, interferon, and complement are some of the soluble mediators of innate immunity. Lysozyme has antibacterial effect due to its action on the bacterial cell wall. Interferons are secreted by cells in response to products of viral infected cells. These substances have a general antiviral effect by preventing the synthesis of viral structural proteins. Complement is a group of serum-soluble substances that when activated damage the cell membrane.
- There are certain types of molecules that are unique to microbes and are never found in multicellular organisms. The ability of the host to immediately recognize and combat invaders displaying such molecules is a strong feature of innate immunity.

**Phagocytosis:** Phagocytosis is another important defense mechanism of the innate immunity. Phagocytosis is a process of ingestion of extracellular particulate material by certain specialized cells, such as blood monocytes, neutrophils, and tissue macrophages. It is a type of endocytosis in which invading microorganisms present in the environment are ingested by the phagocytic cells. In this process, plasma membrane of the cell expands around the particulate material, which may include whole pathogenic microorganisms to form large vesicles called phagosomes.

**Inflammatory responses:** Tissue damage caused by a wound or by an invading pathogenic microorganism induces a complex sequence of events, collectively known as the inflammatory responses. The end result of inflammation may be the activation of a specific immune response to the invasion or clearance of the invader by components of the innate immune system. The four cardinal features of inflammatory responses are *rubor* (redness), *calor* (rise in temperature), *dolor* (pain), and *tumor* (swelling).

**Mediators of inflammatory reactions:** Histamine, kinins, acute-phase proteins, and defensin are the important mediators of inflammatory reactions.

- **Histamine:** It is a chemical substance produced by a variety of cells in response to tissue injury. It is one of the principal mediators of the inflammatory response. It binds to receptors on nearby capillaries and venules, causing vasodilatation and increased permeability.
- **Kinins:** These are other important mediators of inflammatory response. They are normally present in blood plasma in an inactive form. Tissue injury activates these small peptides, which then cause vasodilatation and increased

permeability of capillaries. Bradykinin also stimulates pain receptors in the skin. This effect probably serves a protective role because pain normally causes an individual to protect the injured area.

- **Acute-phase proteins:** These include C-reactive proteins and mannose-binding proteins that form part of the innate immunity. These proteins are produced at an increased concentration in plasma during acute-phase reaction, as a nonspecific response to microorganisms and other forms of tissue injury. They are synthesized in the liver in response to cytokines called **proinflammatory cytokines**, namely, interleukin-1 (IL-1), interleukin-6 (IL-6), and tissue necrosis factor (TNF). They are called proinflammatory cytokines because they enhance the inflammatory responses.
- **Defensins:** They are another important component of the innate immunity. They are cationic peptides that produce pores in membrane of the bacteria and thereby kill them. These are present mainly in the lower respiratory tract and gastrointestinal tract. The respiratory tract contains  $\beta$ -defensins, whereas the gastrointestinal tract contains  $\alpha$ -defensins. The  $\alpha$ -defensins also exhibit antiviral activity. They bind to the CXCR4 receptors and block entry of HIV virus into the cell. How these defensins differentiate microbes from some cells is not known.

### Adaptive (Acquired) Immunity

Adaptive immunity is also called acquired immunity, since the potency of immune response is acquired by experience only. Differences between innate and acquired immunity are summarized in Table 11-1.

**TABLE 11-1** Differences between innate and acquired immunity

Feature	Innate immunity	Acquired immunity
<b>Definition</b>	The resistance to infection that an individual possesses by virtue of genetic and constitutional makeup	The resistance that an individual acquires during life
<b>Types</b>	Nonspecific and specific	Active and passive
<b>Time taken to develop</b>	Hours	Days
<b>Specificity</b>	For structures shared by groups of related microbes	For antigens of microbes and for nonmicrobial antigens
<b>Memory</b>	None; repeated exposure brings response like primary response	Yes; secondary response much faster than primary response
<b>Components</b>		
Physical and chemical barriers	Skin, mucosal epithelia, and antimicrobial chemicals	Lymphocytes in epithelia and antibodies secreted at epithelial surfaces
Blood and tissue antimicrobial substances	Complement; leukins from leukocytes, plakins from platelets, lactic acid found in muscle tissue, lactoperoxidase in milk, and interferons (antiviral)	Antibodies
<b>Cells</b>	Phagocytes (macrophages and neutrophils) and natural killer cells	Lymphocytes

## Key Points

Adaptive immunity shows the following features:

- It is the resistance acquired by an individual during life.
- It occurs after exposure to an agent and is mediated by antibodies as well as T lymphocytes (helper T cells and cytotoxic T cells).
- It has immunologic memory and a remarkable capability of discriminating between self and nonself antigens.
- Once an antigen has been recognized by the cells of acquired immune system, the response to it is specific and can be repeated. In most cases, the acquired immune response improves with repeated exposure.
- The immune response to the second challenge occurs more quickly than the first, is stronger, and is often more effective in neutralizing and clearing the pathogen.

### ► Types of acquired immunity

Acquired immunity against a microbe may be induced by the host's response to the microbe or by transfer of antibodies or lymphocytes specific for the microbes. It is of two types: *active immunity* and *passive immunity*.

#### Active immunity

The immunity induced by exposure to a foreign antigen is called *active immunity*. Active immunity is the resistance developed by an individual after contact with foreign antigens, e.g., microorganisms. This contact may be in the form of:

- clinical or subclinical infection,
- immunization with live or killed infectious agents or their antigens, or
- exposure to microbial products, such as toxins and toxoids.

In all these circumstances, the immune system of the host is stimulated to elicit an immune response consisting of antibodies and activated helper T ( $T_H$ ) cells and cytotoxic T lymphocytes/cells (CTLs).

Active immunity develops after a latent period, during which immunity of the host is geared up to act against the microorganism. Hence it is slow in onset, especially during this primary response. However, once the active immunity develops, it is long-lasting and this is the major advantage of the active immunity. The active immunity is of two types: natural active immunity and artificial active immunity.

- **Natural active immunity:** It is acquired by natural clinical or subclinical infections. Such natural immunity is long-lasting. For example, individuals suffering from smallpox become immune to second attack of the disease.
- **Artificial active immunity:** It is induced in individuals by vaccines. There is a wide range of vaccines available against many microbial pathogens. These may be live vaccines, killed vaccines, or vaccines containing bacterial products (Table 11-2).

**Mediators of active immunity:** Active immunity is mediated by humoral immunity and cell-mediated immunity. These two

TABLE 11-2

### Differences between cell-mediated and humoral immunity

Cell-mediated immunity	Humoral immunity
Immune response mediated by cells	Immune response mediated by antibodies
Protects against fungi, viruses, and facultative intracellular bacterial pathogens	Protects against extracellular bacterial pathogens and viruses infecting respiratory or intestinal tract; and prevents recurrence of viral infections
Mediates delayed (type IV) hypersensitivity	Mediates immediate (types I, II, and III) hypersensitivity
Only T-cell-dependent antigens lead to cell-mediated immunity	B cells directly bind soluble antigens resulting in production of antibodies
Both CD4+ and CD8+ T cells are involved	Only $T_H$ cells are involved
Provides immunological surveillance and immunity against cancer	No major role in immunological surveillance
Participates in rejection of homografts and graft-versus-host reaction	May be involved in early graft rejection due to preformed antibodies

types of immunities are mediated by different components of the immune system and function in different ways to kill different types of pathogens.

- **Humoral immunity:** It is mediated by molecules in the blood and mucosal secretions called antibodies. The antibodies are secreted by a subset of lymphocytes known as B cells. The antibodies recognize microbial antigens, combine specifically with the antigens, neutralize the infectivity of microbes, and target microbes for elimination by various effector mechanisms. Humoral immunity is the principal defense mechanism against extracellular microbes.
- **Cell-mediated immunity:** It is mediated by both activated  $T_H$  cells and CTLs. Cytokines secreted by  $T_H$  cells activate various phagocytic cells, enabling them to phagocytose and kill microorganisms. This type of cell-mediated immune response is especially important against a host of bacterial and protozoal pathogens. CTLs play an important role in killing virus-infected cells and tumor cells. They act by killing altered self-cells.

Differences between humoral and cell-mediated immunities are summarized in Table 11-2.

**Antigen recognition:** Antigens, which are generally very large and complex, are not recognized in their entirety by lymphocytes. Instead, both B and T lymphocytes recognize discrete sites on the antigens called *antigenic determinants*, or *epitopes*. Epitopes are the immunologically active regions on a complex antigen, the regions that actually bind to B-cell or T-cell receptors.



B cells and T cells differ in their mechanisms of antigen recognition. While B cells recognize the antigen by interacting with the epitope on their own, T cells recognize the antigen only when the epitope is “presented” by one of the specialized antigen-presenting cells. Once the antigen has been recognized, these cells then go on to diversify by several intricate mechanisms. This diversification helps in conferring the specificity, one of the cardinal characteristics of the immune system.

**Major histocompatibility complex (MHC):** It is a large genetic complex with multiple loci. The MHC loci encode two major classes of membrane-bound glycoproteins: class I and class II MHC molecules. Class II molecules present antigens to the T<sub>H</sub> cells, while class I molecules do the same for CTLs. In order for a foreign protein antigen to be recognized by a T cell, it must be degraded into small antigenic peptides that form complexes with class I or class II MHC molecules. This conversion of proteins into MHC-associated peptide fragments is called antigen processing and presentation.

### Passive immunity

When immunity is conferred by transfer of serum or lymphocytes from a specifically immunized individual, it is known as **passive immunity**. This is a useful method for conferring resistance rapidly, i.e., without waiting for the development of an active immune response. Passive immunity may be natural or artificial.

**Natural passive immunity:** It is observed when IgG is passed from mother to fetus during pregnancy. This forms the basis of prevention of neonatal tetanus in neonates by active immunization of pregnant mothers. It is achieved by administering tetanus toxoid to pregnant mothers during the last trimester of pregnancy. This induces production of high level of antibodies in mother against tetanus toxin, which are subsequently transmitted from mother to fetus through placenta. The antibodies subsequently protect neonates after birth against the risk of tetanus. Natural passive immunity is also observed by passage of IgA from mother to newborn during breast feeding.

**Artificial passive immunity:** It is induced in an individual by administration of preformed antibodies, generally in the form of antiserum, raised against an infecting agent. Administration of these antisera makes large amounts of antibodies available in the recipient host to neutralize the action of toxins.

The preformed antibodies against rabies and hepatitis A and B viruses, etc. given during incubation period prevent replication of virus, and hence alter the course of infection. Immediate availability of large amount of antibodies is the main advantage of passive immunity. However, short lifespan of these antibodies and the possibility of hypersensitivity reaction, if antibodies prepared in other animal species are given to individuals who are hypersensitive to these animal globulins (e.g., serum sickness), are the two noted disadvantages of passive immunity.

TABLE 11-3

### Differences between passive and active immunity

Passive immunity	Active immunity
No active host participation; received passively	Produced actively by host's immune system
Antibodies transferred directly	Antibodies induced by infection or by immunogens
Passive immunity is due to readymade antibodies	Active immunity often involves both the cell-mediated and humoral immunity
Types: <i>Natural</i> —transfer of maternal antibodies through placenta; <i>Artificial</i> —injection of immunoglobulins	Types: <i>Natural</i> —clinical or inapparent infection; <i>Artificial</i> —induced by vaccines
Immediate immunity; no lag period	Immunity effective only after lag period
Transient; less effective	Durable; effective protection
No immunological memory	Immunological memory present
Subsequent dose less effective due to immune elimination	Booster effect on subsequent dose
No negative phase	Negative phase may occur
Applicable even in immunodeficient	Not applicable in immunodeficient

Differences between active and passive immunity are summarized in Table 11-3.

Combined passive–active immunity is carried out by giving both preformed antibodies (antiserum) and a vaccine to provide immediate protection and long-term protection, respectively, against a disease. This approach is followed for prevention of certain infectious conditions, namely, tetanus, rabies, and hepatitis B.

### Local Immunity

The immunity at a particular site, generally at the site of invasion and multiplication of a pathogen, is referred to as **local immunity**. Local immunity is conferred by secretory IgA antibodies in various body secretions. These antibodies are produced locally by plasma cells present on mucosal surfaces or in secretory glands. Natural infection or attenuated live viral vaccines given orally or intranasally induces local immunity at gut mucosa and nasal mucosa, respectively.

### Herd Immunity

Herd immunity refers to an overall *level of immunity in a community*. Eradication of an infectious disease depends on the development of a high level of herd immunity against the pathogen. Epidemic of a disease is likely to occur when herd immunity against that disease is very low indicating the presence of a larger number of susceptible people in the community.

# Antigen

## Introduction

Molecules that can be recognized by the immunoglobulin receptor of B cells or by the T-cell receptor when complexed with major histocompatibility complex (MHC) are called **antigens**. The word antigen is a shortened form of the words “antibody generator.” Antigens are substances that react with antibodies, while **immunogens** are molecules that induce an immune response. In most cases, antigens are immunogens, and the terms are used interchangeably. The antigens that are not immunogenic but can take part in immune reactions are termed as **haptens**. The term **immunogenicity** means the ability of an antigen to elicit an immune reaction in the form of a B-cell or T-cell response, whereas the term **antigenicity** means just the ability to combine specifically with the products of the above responses. All molecules that are immunogenic are antigenic too, but all antigenic molecules cannot be considered immunogenic. Thus, haptens can be said to lack immunogenicity.

## Determinants of Antigenicity

A number of factors have been identified that make a substance immunogenic. Some of the important determinants of antigenicity include:

1. Molecular size
2. Foreignness
3. Chemical-structural complexity
4. Stability
5. Other factors

## Molecular Size

In general, protein molecules with large molecular weight are highly antigenic. Substances with molecular weights of about 100,000 Da and more are highly immunogenic, while substances with molecular weights of less than 5000 Da are generally not immunogenic. This property has been exploited in experimental studies by using high molecular weight proteins like bovine gamma globulin (MW 150,000 Da) to induce an immune reaction. Substances with low molecular weight may be made antigenic by adsorbing these on carrier particles, such as bentonite, kaolin, and other inert particles.

## Foreignness

To be immunogenic, a molecule must be recognized as nonself, i.e., foreign. The molecule is considered self or nonself by the immune system depending on whether or not the molecule was exposed to the immune system during fetal development.

**Foreignness** implies ability of the host to tolerate self-antigens. Tolerance to self-antigens develops by contact with them in the initial phases of the development of immune system, particularly during the development of lymphocytes.

In general, the more distantly related two species are, the greater the immunogenicity of a molecule from one species will be when exposed to the other. For example, the bovine serum albumin is more immunogenic in a chicken than in a goat. A graft from an unrelated human will be rejected within about 2 weeks unless immunosuppressive drugs are used, but a graft from a chimpanzee will be rejected within hours even if drugs are used. In contrast, a kidney graft from an identical twin will be accepted readily.

## Chemical-Structural Complexity

Proteins are the most potent immunogens followed by polysaccharides. Nucleic acids and lipids are not efficient in eliciting a good immune reaction, although they may act as haptens. Structural complexity of a protein contributes to its immunogenicity. Chains of single amino acids or single sugars are poorly immunogenic, but if different amino acids or sugars are combined in the same molecule, the immunogenicity is greatly enhanced.

In cell-mediated immunity, the response of T cells to the peptide component of the proteins depends on how the peptide is recognized and presented by the MHC cells. Therefore, the structure of protein plays an important role in its immunogenicity, especially in inducing cellular immunity.

The lipid-specific antibodies are not easily produced; hence, they do not play a major role in immunity. However, these antibodies have a role in the measurement of certain lipid-based molecules and drugs. These antibodies are produced first by treating lipids with haptens and then conjugating with suitable carrier molecules, such as the proteins (e.g., hemocyanin or bovine serum albumin).

## Stability

Highly stable and nondegradable substances (e.g., some plastics, metals, or chains of D-amino acids) are not immunogenic.

This is because internalization, processing, and presentation by antigen-presenting cells (APCs) are always essential to mount an immune response. Therefore, very stable substances (such as silicon) have been successful as nonimmunogenic materials for reconstructive surgeries, such as breast implants.

On the other hand, if a substance is very unstable, it may break up before an APC can be internalized, and hence become immunogenic. In addition, large, insoluble complexes are more immunogenic than smaller, soluble ones. This is because macrophages find it easier to phagocytose, degrade, and present the insoluble complexes than the soluble complexes.

## Other Factors

### ► Biological system

Biological system also plays an important role in determining the immunological efficiency of an antigen. Some substances are immunogenic in one individual but not in others (i.e., responders and nonresponders). This is due to the fact that individuals may lack or have altered genes that code for the receptors for antigen on B cells and T cells, or they may not have the appropriate genes needed for the APC to present antigen to the helper T ( $T_H$ ) cells.

### ► Dosage and route of the antigen

The dose of antigen and the route by which it comes into contact with the immune system also influence immunogenicity of the antigen. Very low doses of antigen do not stimulate immune response, either because too few lymphocytes are contacted or because a nonresponsive state is elicited. Conversely, an extremely high dose also fails to elicit tolerance.

Repeated administration of antigens (booster doses) may be required to enhance immune response of the host to certain antigens. This is particularly important in case of vaccines where a prerequisite immune level needs to be attained. Hence the booster doses of vaccines, such as DPT (Diphtheria, Pertussis, Tetanus), DT (Diphtheria, Tetanus), etc., are given to ensure good protective levels of antibodies. Generally, antigens are administered by the parenteral route to produce good level of antibodies. The antigens can be given by (a) intravenous, (b) subcutaneous, (c) intradermal, (d) intramuscular, (e) intraperitoneal, and (f) mucosal routes. Usually, the subcutaneous route of administration proves to be better than intravenous routes at eliciting an immune response.

### ► Adjuvants

Adjuvants are the substances that when mixed with an antigen and injected with it boost the immunogenicity of the antigen. Adjuvants increase both the strength and the duration of immune response. Adjuvants boost immunogenicity of antigens in several ways:

- Adjuvants like aluminum potassium sulfate (alum) and Freund's water-in-oil adjuvant prolong the persistence of antigen by forming a depot at the injection site. Alum

precipitates the antigen and releases it a little at a time. The water-in-oil emulsion forms small droplets with the antigen and also releases these slowly over time.

- Freund's complete adjuvant contains, in addition to the emulsifying factors, heat-killed mycobacteria. The bacterial components activate macrophages and increase both the production of IL-1 and the level of B7 membrane molecules, which enhances the immune response. The increased expression of class II MHC increases the ability of APC to present antigen to  $T_H$  cells. B7 molecules on the APC bind to CD28, a cell-surface protein on  $T_H$  cells, triggering costimulation, an enhancement of the T-cell immune response.
- Some adjuvants, like synthetic polyribonucleotides and bacterial lipopolysaccharides, stimulate nonspecific lymphocyte proliferation and bring about their action.

## Antigenic Specificity

Antigenic specificity of the antigen depends on antigenic determinants or epitopes.

### Epitopes

An *epitope* is defined as the immunologically active region of an immunogen that binds to antigen-specific membrane receptors on lymphocytes or secreted antibodies. The interaction between cells of the immune system and antigens takes place at many levels and the complexity of any antigen is mirrored by its epitope. There are two types of epitopes: B-cell epitopes and T-cell epitopes.

#### ► B-cell epitopes

B-cell epitopes are antigenic determinants recognized by B cells. B-cell epitope can combine with its receptor only if the antigen molecule is in its native state. The complementary surfaces of the antibody and the antigen molecules appear to be relatively flat. Smaller molecules often fit nicely within a particular depression or groove in the antigen-binding site of the antibody molecule.

The B-cell epitope is about six or seven sugar residues or amino acids long. B-cell epitopes tend to be hydrophilic and are often located at bends in the protein structure. They are also often found in regions of proteins, which have a higher mobility; this may make it possible for an epitope to shift just a bit to fit into an almost-right site.

#### ► T-cell epitopes

T cells recognize amino acids in proteins but do not recognize polysaccharide or nucleic acid antigens. This is the reason why polysaccharides are considered as T-independent antigens and proteins as T-dependent antigens. The primary sequence of amino acids in proteins determines the antigenic determinants recognized by T cells. Free peptides are not recognized by T cells, while the complex of MHC molecules and peptide are recognized by T cells. Thus for a T-cell response, it should

recognize both the antigenic determinant and also the MHC, and therefore it is said to be MHC restricted.

In general, T-cell epitopes or antigenic determinants are small and are only 8–15 amino acids long. The antigenic determinants are limited to those parts of the antigen that can bind to MHC molecules. Since the MHC molecules are subjected to genetic variability, there can be difference among individuals in their T-cell response to the same stimulus. Each MHC molecule can bind several, but not all, peptides. Therefore, for a peptide to be immunogenic in a particular individual, that individual must have MHC molecules that can bind to it.

### Key Points

Processing of an antigen by APCs is absolutely essential for a T cell to recognize it. Two different types of processing can prepare a protein antigen for antigen presentation. These include:

- **Externally derived antigens' processing:** In this process, phagocytosed bacteria are killed and lysed by phagocytic cells, such as macrophages. Pieces of the bacteria are then processed and presented in the context of class II MHC molecules.
- **Endogenously derived antigens' processing:** In this process, virus proteins synthesized in a cell are processed and then presented in the context of class I MHC molecules.

### Species Specificity

Tissues of all individuals in a species possess certain species-specific antigens. However, some degree of cross-reaction occurs between antigens from related species. The species specificity shows phylogenetic relationship. The phylogenetic relationship is useful in:

- Tracing evolutionary relationship between species.
- The species identification from blood and seminal stains in forensic medicine.

### Isospecificity

Isospecificity is determined by the presence of isoantigens or histocompatibility antigens.

### Isoantigens

Isoantigens are antigens found in some, but not all, members of a species. A species may be grouped depending on the presence of different isoantigens in its members. These are genetically determined. Human erythrocyte antigens, based on which individuals are classified into different blood groups, are the best examples of isoantigens in humans. The blood groups are of primary importance in:

- Transfusion of blood and blood products,
- Isoimmunization during pregnancy, and

- Providing valuable evidence in paternity disputes, the results of which are supplemented by more recent DNA fingerprinting tests.

### Histocompatibility Antigens

Histocompatibility antigens are the cellular determinants specific for each individual of a species. These antigens are associated with the plasma membrane of tissue cells. Human leukocyte antigen (HLA) is the major histocompatibility antigen that determines the homograft rejection. Therefore, HLA typing is absolutely essential before carrying out transplantation of tissue or organ from one individual to another.

### Autospecificity

Self-antigens are generally nonantigenic. Sequestered antigens (such as eye lens protein and sperm) are, however, exceptions, because these are not recognized as self-antigens. This is because corneal tissue and sperm are never encountered by the immune system during the development of tolerance to self-antigens. Therefore, these tissues become immunogenic if accidentally or experimentally released into the blood or tissues.

### Organ Specificity

Antigens characteristic of an organ or tissues are called organ-specific antigens. These antigens found in the brain, kidney, and lens tissues, even of different animal species, share the same antigen specificity. Organ-specific antigens, such as brain-specific antigens, shared by human and sheep brain are one such example. The antirabies vaccines prepared from sheep brain, when given, may induce immune response in some humans, causing damage to neural tissues of the recipient. This may result in neuromuscular complications in some individuals.

### Heterophile Specificity

Heterophile specificity is determined by the presence of heterophile antigens. The same or closely related antigens, sometimes present in tissues of different biological species, classes, or kingdoms are known as *heterophile antigens*. Antibodies against the heterophile antigens produced by one of the species cross-react with the antigens of other species. This property is exploited for diagnosis of many infectious diseases. Weil–Felix reaction, Paul-Bunnell test, and cold agglutination tests are the examples of serological tests that use such heterophile antigens.

## Key Points

- **Weil-Felix reaction** is a test used for diagnosis of rickettsial infections, in which the strains of *Proteus* species (such as OX 19, OX 2, and OX K) are used to detect heterophile antibodies produced against rickettsial pathogens.
- **Paul-Bunnell test** is used for diagnosis of infectious mononucleosis caused by Epstein-Barr virus infection by demonstration of heterophile antibodies that agglutinate sheep erythrocytes.
- **Cold agglutinin test** is performed for diagnosis of primary atypical pneumonia caused by *Mycoplasma pneumoniae* by demonstration of heterophilic antibodies.

## Haptens

Haptens are small organic molecules that are antigenic but not immunogenic. They are not immunogenic because they cannot activate helper T cells. Failure of hapten to activate helper T cells is due to their inability to bind to MHC proteins; they cannot bind because they are not proteins and only proteins can be presented by MHC proteins. Moreover, haptens are univalent hence cannot activate B cells by themselves.

The haptens, however, can activate B cells when covalently bound to a “carrier” protein. When bound with a carrier molecule, they form an immunogenic hapten-carrier conjugate (Fig. 12-1). In this process, the haptens combine with an IgM receptor on the B cells, and the hapten-carrier protein complex is internalized. A peptide of the carrier protein is presented in association with class II MHC protein to the helper T cells. The activated helper T cells then produce interleukins, which stimulate the B cells to produce antibodies to hapten.

Animals immunized with such a conjugate produce antibodies specific for (a) the hapten determinant, (b) unaltered

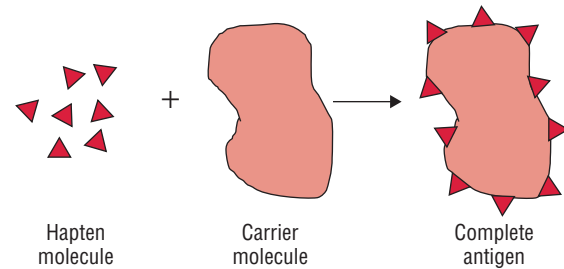

**FIG. 12-1.** Hapten-carrier conjugate.

epitopes on the carrier protein, and (c) new epitopes formed by combined parts of both the hapten and carrier. In fact, the hapten-carrier molecule is bound to surface immunoglobulins on B cells via the hapten epitopes. The hapten-carrier molecule is then taken in, processed, and pieces of the carrier are presented by these B cells and  $T_H$  cells. In the body, the formation of hapten-carrier conjugates is the basis for development of allergic responses to drugs, such as penicillin.

## Superantigens

Superantigens are a class of molecules that can interact with APCs and T lymphocytes in a nonspecific way. The superantigens act differently by interacting with MHC class II molecules of the APC and the V $\beta$  domain of the T-lymphocyte receptor. This interaction results in the activation of a larger number of T cells (10%) than conventional antigens (1%), leading to massive cytokine expression and immunomodulation. Examples of superantigens are staphylococcal enterotoxins, toxic shock syndrome toxin, exfoliative toxins, and also some viral proteins.

# Antibodies

## Introduction

Antibodies are globulin proteins (immunoglobulins) that are synthesized in serum and tissue fluids, which react specifically with the antigen that stimulated their production. Three types of globulins are present in the blood: alpha, beta, and gamma.

The antibodies are the gamma globulins. Antibodies are one of the major plasma proteins, and against infection often referred to as “first line of defense”. The most important function of antibodies is to confer protection against microbial pathogens. Antibodies confer protection in the following ways:

1. They prevent attachment of microbes to mucosal surfaces of the host.
2. They reduce virulence of microbes by neutralizing toxins and viruses.
3. They facilitate phagocytosis by opsonization of microbes.
4. They activate complement, leading to complement-mediated activities against microbes.

Von Behring and Kitasato performed the first experiments that proved the physical existence of antibodies in 1890. They demonstrated that serum obtained from rabbits immunized with tetanus or diphtheria toxins could prevent disease in mice infected with such pathogens. The unknown substance that was present in serum and that provided protection on transfer was named “antitoxin” by Tizzoni and Cattani in 1891. Subsequently, experimental works by Paul Ehrlich and Jules Bordet demonstrated that a protective response could be generated even against whole cells (erythrocytes). The more inclusive term *antibody* subsequently replaced the term *antitoxin*.

Tiselius and Kabat accomplished the first successful attempt to identify antibody molecules in 1939. They demonstrated that hyperimmunization increased the concentration of  $\gamma$ -globulins in serum and that this fraction contained antibody activity. Because  $\gamma$ -globulins are large-molecular-weight proteins, it was suggested that further characterization of antibodies requires breaking them into smaller and easily handled fragments.

Porter in 1959, succeeded in digesting rabbit immunoglobulin G (IgG) with the proteolytic enzyme papain. These produced two distinct fragments: a monovalent fragment with antigen-binding activity, termed Fab (fragment antigen binding) and a second fragment that retained the antibody’s effector functions and crystallized readily into a lattice, termed Fc (fragment crystallizable). Edelman and Poulik using a similar method splitted

myeloma globulins into two distinct components, which subsequently were termed heavy (H) and light (L) chains.

The World Health Organization (WHO) in 1964 coined the term “immunoglobulin (Ig)” for the term antibody. The immunoglobulin includes not only antibody globulins but also the cryoglobulins, macroglobulins, and abnormal myeloma proteins. Thus, all antibodies are immunoglobulins but not all immunoglobulins may be antibodies.

## Immunoglobulins

There are five classes of immunoglobulins: (i) immunoglobulin G (IgG), (ii) immunoglobulin M (IgM), (iii) immunoglobulin A (IgA), (iv) immunoglobulin E (IgE), and (v) immunoglobulin D (IgD). Myeloma proteins were first used for the amino acid sequencing of immunoglobulins. These proteins were also the first immunoglobulins that were subjected to crystallographic studies. They provided the first glimpses of the domain structure of the prototypic immunoglobulin.

## Structure of Immunoglobulins

Immunoglobulins show the following properties:

- They are glycoproteins.
- They are a complex structure of four polypeptide chains: two identical heavy (typically 55 kDa each) chains and two identical light chains (25 kDa each). This gives immunoglobulin an overall ‘Y’ or ‘T’ shape, which is the most widely recognized feature of immunoglobulin structure.
  - The terms “heavy” and “light” refer to the molecular weights of the chains. The heavy chains have a molecular weight of 50,000–70,000 Da, while light chains have a molecular weight of 25,000 Da. The heavy chains are longer, and light chains are shorter (Fig. 13-1).

### ► Heavy chains

An immunoglobulin molecule has two heavy chains. Each heavy chain is made up of 420–440 amino acids. The two heavy chains are held together by one to five disulfide (S–S) bonds. Each heavy chain is bound to a light chain by a disulfide bond and by noncovalent bonds, such as salt linkages, hydrogen bonds, and hydrophobic bonds to form a heterodimer (H–L). Similar noncovalent interactions and disulfide bridges link the two identical heavy and light (H–L) chains to each other to form the basic four-chain (H–L)<sub>2</sub> antibody structure.

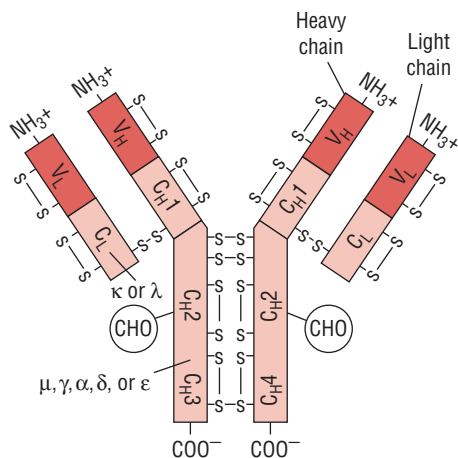

FIG. 13-1. Schematic diagram of monomer of the immunoglobulin.

TABLE 13-1

**Classes of immunoglobulins and their heavy chains and subclasses**

Class	Heavy chain	Subclasses
IgG	Gamma	$\gamma_1, \gamma_2, \gamma_3, \gamma_4$
IgM	Mu	None
IgA	Alpha	$\alpha_1, \alpha_2$
IgE	Epsilon	None
IgD	Delta	None

The heavy chains of a given antibody molecule determine the class of that antibody. For example, IgM contains mu ( $\mu$ ), IgG contains gamma ( $\gamma$ ), IgA contains alpha ( $\alpha$ ), IgD contains delta ( $\delta$ ), and IgE contains epsilon ( $\epsilon$ ) heavy chains (Table 13-1). These heavy chains are structurally and antigenically distinct for each class of immunoglobulin. They differ in their size, carbohydrate content, and as antigens.

### ► Light chains

An immunoglobulin molecule has two light chains. Each light chain is made up of 220–240 amino acids. Light chain is attached to the heavy chain by a disulfide bond. The light chains are structurally and chemically similar in all classes of immunoglobulins. They are of two types: kappa ( $\kappa$ ) and lambda ( $\lambda$ ). These two types differ in their amino acids present in constant regions. Each immunoglobulin has either two  $\kappa$  or two  $\lambda$  chains but never both. The  $\kappa$  and  $\lambda$  chains are present in human serum in a ratio of 2:1.

### ► Variable and constant regions

Each polypeptide chain of an immunoglobulin molecule contains an amino terminal part and a carboxy terminal part. The amino terminal part is called the variable region (**V region**) and the carboxy terminal part is called the constant region (**C region**).

Both heavy and light chains contain variable and constant regions. These regions are composed of three-dimensional folded structures with repeating segments, which are called **domains**. Each heavy chain consists of one variable (VH) and

three constant (CH) domains. IgG and IgA have three CH domains (CH1, CH2, and CH3), whereas IgM and IgE have four domains (CH1, CH2, CH3, and CH4). Each light chain consists of one variable (VL) and one constant domain (CL).

**Variable region:** The amino-terminal half of the light or heavy chain, consisting of 100–110 amino acids, is known as variable or **V regions** (VL in light chains and VH in heavy chains). V region is different for each class of immunoglobulin.

The variable regions of both light and heavy chains consist of three highly variable regions known as **hypervariable regions**. The antigen combining sites Fab of the antibody molecule that consists of only 5–10 amino acids each are present in the hypervariable region of both the light and heavy chains. These antigen-binding sites are responsible for specific binding of antibodies with antigens. The high specificity of antibodies is primarily due to the presence of these hypervariable regions.

**Constant region:** The carboxyl-terminal half of the molecule is called the constant (C) region. It consists of two basic amino acid sequences. The Fc fragment, found to crystallize under low ionic conditions, is present in the constant region of heavy chain.

The constant region of the heavy chain has many biological functions. It is responsible for activation of the complement, binding to cell surface receptors, placental transfer, and many other biological activities.

The constant region of the light chain has no biological function.

A single antibody molecule has two identical heavy chains and two identical light chains, H<sub>2</sub>L<sub>2</sub>, or a multiple (H<sub>2</sub>L<sub>2</sub>)<sub>n</sub> of this basic four-chain structure. Subisotypes exist for  $\alpha$  and  $\gamma$  chains, and this leads to the existence of subclasses of the respective immunoglobulins.

## Treatment of Immunoglobulins with Proteolytic Enzymes

The immunoglobulin molecule can be broken into a number of “sections” or “fragments” by action of proteolytic enzymes. The proteolytic enzyme papain cleaves just above the interchain disulfide bonds linking the heavy chains, whereas the enzyme pepsin cleaves just below these bonds, thereby generating different digestion products. For example, peptide bonds in the “hinge” region are broken on treatment of antibody molecule with papain, resulting in production of two identical Fab fragments and one Fc fragment. The Fab fragments produced during cleavage monovalently bind to the antigen. Treatment with pepsin cleaves immunoglobulin but at a different site, producing an Fc fragment and two Fab fragments, F(ab)<sub>2</sub>, which upon exposure to reducing conditions are separated into Fab monomeric units.

## Immunoglobulin Antigen Determinants

There are three major types of immunoglobulin antigen determinants: isotypes, allotypes, and idiotypes.

## ► Isotypes

The *isotype* of an immunoglobulin refers to the particular constant region of the light- or heavy-chain of the immunoglobulin. Immunoglobulins are classified on the basis of various heavy chain isotypes. Heavy chains are distinguished by the presence of heavy chain markers, such as  $\mu$ ,  $\gamma$ ,  $\alpha$ ,  $\delta$ , and  $\epsilon$  in the immunoglobulins IgM, IgG, IgA, IgD, and IgE, respectively. The light chains are also distinguished by isotype markers, such as  $\kappa$  and  $\lambda$ . Isotypes are present in all members of a species.

## ► Allotypes

The *allotype* refers to allelic differences in both the variable and constant regions of immunoglobulin. The allotype markers are present on the constant regions of light and heavy chains. They are Am on  $\alpha$  heavy chains, Gm on  $\gamma$  heavy chains, and Km on  $\kappa$  light chains. Allotype markers are absent on  $\mu$ ,  $\delta$ , and  $\epsilon$  heavy chains and on  $\lambda$  light chains. More than 25 Gm types, 3 Km allotypes, and 2 Am on IgA have been described. Allotypes are present in some but not all members of a species and are inherited in a simple Mendelian fashion.

## ► Idiotypes

The *idiotype* refers to a specificity that is associated with the variable region. Idiotype markers are found on the hypervariable region of the immunoglobulin. Idiotypes are specific for each antibody molecule. Anti-idiotypic antibodies produced against Fab fragments prevent antigen-antibody interaction.

## Biosynthesis of Immunoglobulins

B lymphocytes and plasma cells take part in the synthesis of immunoglobulins. Resting B cells synthesize only small amounts of immunoglobulins that mainly get incorporated into cell membranes. Plasma cells, the most differentiated B cells, are specialized to produce and secrete large amounts of immunoglobulins. The synthetic capacity of the plasma cells is reflected by the abundant cytoplasm, which is extremely rich in endoplasmic reticulum.

Normally, heavy and light chains are synthesized in separate polyribosomes of the plasma cell. The amounts of heavy and light chains synthesized on the polyribosomes are usually balanced and so both types of chains are combined to produce complete Ig molecules, without excess of any given chain. The assembly of a complete Ig molecule is carried out either by associating one heavy and one light chain to form an H-L hemimolecule, and then joining two H-L hemimolecules to form a single complete molecule (H<sub>2</sub>L<sub>2</sub>), or by forming H<sub>2</sub> and L<sub>2</sub> dimers that later associate to form the complete molecule.

While free light chains can be effectively secreted from plasma cells, free heavy chains are generally not secreted. The heavy chains are synthesized and transported to the endoplasmic reticulum, where they are glycosylated, but secretion requires combination with light chains to form a complete immunoglobulin molecule. If light chains are not synthesized or heavy chains are synthesized in excess, the free heavy

chains combine through their CH1 domain with a heavy-chain-binding protein, which is believed to be responsible for their intracytoplasmic retention.

Both IgM and IgA are the polymeric antibodies, which have one additional polypeptide chain, the J chain. The J chain is synthesized by all plasma cells, including those that produce IgG. However, it is only incorporated to polymeric forms of IgM and IgA. It is believed that the J chain has some role in initiating polymerization. IgM proteins are assembled in two steps. First, the monomeric units are assembled. Then, five monomers and one J chain combine via covalent bonds to produce a pentameric molecule.

## Metabolism of Immunoglobulins

Half-life ( $T_{1/2}$ ) of immunoglobulin is one of the most commonly used parameters to assess the catabolic rate of immunoglobulins. The half-life corresponds to the time elapsed for a reduction to half of a circulating immunoglobulin concentration after equilibrium has been reached. This is usually determined by injecting an immunoglobulin labeled with a radioisotope (<sup>131</sup>I).

The IgG is the immunoglobulin class with the longest half-life (average of 21 days), with the exception of IgG3. The IgG3 has a considerably shorter half-life (average of 7 days) that is nearer to that of IgA (5–6 days) and IgM (5 days).

The synthesis rate of IgA1 (24 mg/kg/day) is not very different from that of IgG1 (25 mg/kg/day), but the serum concentration of IgA1 is about one-third of the IgG1 concentration. This is explained by a fractional turnover rate three-times greater for IgA1 (24%/day). The highest fractional turnover rate and shorter half-life are those of IgE (74%/day and 2.4 days, respectively). The lowest synthesis rate is that of IgE (0.002 mg/kg/day, compared to 20–60 mg/kg/day for IgG).

## Immunoglobulin Classes

The structure and biological functions of five classes of immunoglobulins (IgG, IgM, IgA, IgE, and IgD) are described below:

### ► Immunoglobulin G

IgG is a 7S immunoglobulin with a molecular weight of 150,000 Da. It has a half-life of 23 days—longest among all the immunoglobulins. Other properties of the IgG are given in Table 13-2.

IgG is the most abundant class of immunoglobulins in the serum, comprising about 80% of the total serum immunoglobulin. There are four IgG subclasses IgG1, IgG2, IgG3, and IgG4—so numbered according to their decreasing concentrations in serum. Though the differences between these subclasses are minute, their functions vary as follows:

1. IgG1, IgG3, and IgG4 are special because these are the only immunoglobulins with the ability to cross the placental barrier. They play an important role in protecting the developing fetus against infections.
2. IgG3, IgG1, and IgG2, in order of their efficiency, are effective in the activation of the complement.



TABLE 13-2

Comparison of various properties of immunoglobulins

Characteristics	IgG	IgA	IgM	IgD	IgE
Structure	Monomer	Dimer	Pentamer	Monomer	Monomer
Percentage of total serum	80%	10–13%	5–8%	0.2%	0.002%
Location	Blood, lymph, and intestine	Blood, lymph, and B cell surface	Secretions	B cell surface, blood, and lymph	Bound to mast and basophil cell
Sedimentation coefficient	7	7	19	7	8
Molecular weight (kDa)	150	160	900	180	190
Carbohydrate (%)	3	8	12	13	12
Serum concentration (mg/mL)	12	2	1.2	0.03	0.00004
Half-life (days)	23	6–8	5	2–8	1–5
Heavy chain	$\gamma_1, \gamma_2, \gamma_3, \gamma_4$	$\alpha_1, \alpha_2$	$\mu$	$\delta$	$\epsilon$
Light chain	$\kappa$ or $\delta$	$\kappa$ or $\delta$	$\kappa$ or $\delta$	$\kappa$ or $\delta$	$\kappa$ or $\delta$
Complement binding	Classical pathway	Alternate pathway	Classical pathway	None	None
Placental transport	+	–	–	–	–
Present in milk	+	+	–	–	–
Seromucous secretion	–	+	–	–	–
Heat stability (56°C)	+	+	+	+	–
Binding to tissue	Heterologous	None	None	None	Homologous

3. IgG1 and IgG3 bind with high affinity to Fc receptors on phagocytic cells and thus mediate opsonization. IgG4 has an intermediate affinity for Fc receptors and IgG2 has an extremely low affinity.

Two  $\gamma$  chains, along with two  $\kappa$  or  $\gamma$  light chains, joined together by disulfide bonds, comprise an IgG molecule as follows:

- The  $\gamma$  chain is a 51-kDa, 450-amino acid residue heavy polypeptide chain.
- It consists of one variable VH domain and a constant (C) region with three domains designated CH1, CH2, and CH3.
- The hinge region is situated between CH1 and CH2.
- Proteolytic enzymes, such as papain and pepsin, cleave an IgG molecule in the hinge region to produce Fab and F(ab')<sub>2</sub> and Fc fragments.

There are four subclasses of IgG in humans with four corresponding  $\gamma$  chain isotypes designated  $\gamma$ -1,  $\gamma$ -2,  $\gamma$ -3, and  $\gamma$ -4. IgG1, IgG2, IgG3, and IgG4 show differences in their hinge regions and differ in the number and position of disulfide bonds that link two  $\gamma$  chains in each IgG molecule. There is only a 5% difference in amino acid sequence among human  $\gamma$  chain isotypes, exclusive of the hinge region. Cysteine residues, which make it possible for interheavy ( $\gamma$ ) chain disulfide bonds to form are found in the hinge area. IgG1 and IgG4 have two interheavy chain disulfide bonds, IgG2 has 4, and IgG3 has 11. The IgG, is distributed equally in the intra- and extravascular compartments.

## Key Points

IgG shows the following biological activities:

- In response to infection, IgG antibodies appear late after appearance of IgM antibodies, but persists for a longer period.
- It confers protection against the microorganisms that are present in the blood and tissues. It is distributed equally in the intra- and extravascular compartments.
- It is the only immunoglobulin that crosses the placenta; hence, it confers natural passive immunity to the newborns.
- It takes part in precipitation, complement fixation, and neutralization of toxins and viruses.
- It binds to microorganisms and facilitates the process of phagocytosis of microorganisms.

## Immunoglobulin M

IgM constitutes about 5–8% of total serum immunoglobulins. It is distributed mainly intravascularly. It is a heavy molecule (19S) with a molecular weight varying from 900,000 to 1,000,000 Da (*millionaire molecule*). It has a half-life of 5 days (Table 13-2).

IgM is basically a pentamer, composed of five immunoglobulin subunits (monomeric subunits, IgMs) and one molecule of J chain. Each monomeric IgM is composed of two light chains ( $\kappa$  or  $\gamma$  light chains) and two heavy chains ( $\mu$ ). The heavy chains are larger than those of IgG by about 20,000 Da, corresponding to an extra domain on the constant region

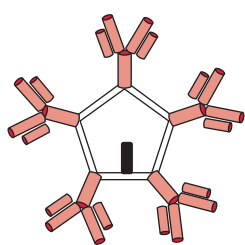

IgM IgM is pentameric. It is an effective first line defense against foreign bodies. IgM is produced in the primary immune response

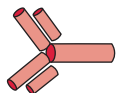

IgG IgG is monomeric. It is an effective defense against extravascular compartments from foreign bodies and their components

IgD IgD is monomeric. It influences lymphocyte functions

IgE IgE is monomeric. It gives protection against intestinal parasites and is responsible for many of symptoms of allergy

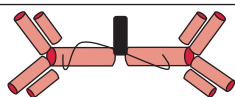

IgA IgA is dimeric. It gives protection to mucosal surfaces

FIG. 13-2. Schematic diagram of immunoglobulins and their functions.

(CH4). Two subclasses of IgM (IgM1 and IgM2) are described, which differ in their  $\mu$  chains. IgM1 consists of  $\mu_1$  and IgM2 consists of  $\mu_2$  chains (Fig. 13-2).

The immunoglobulin  $\mu$  chain is a 72 kDa, 570-amino acid heavy polypeptide chain comprising one variable region, designated VH, and a four-domain constant region, designated CH1, CH2, CH3, and CH4. The  $\mu$  chain does not have a hinge region. A "tail piece" is located at the carboxy terminal end of the chain. It comprises 18-amino acid residues. A cysteine residue at the penultimate position of a carboxy terminal region of the  $\mu$  chain forms a disulfide bond that joins to the J chain. There are five N-linked oligosaccharides in the  $\mu$  chain of humans.

Monomeric IgM, with a molecular weight of 180,000 Da, is expressed as membrane-bound antibody on B cells. As mentioned earlier, the J chain found in the IgM molecule was believed to play a major role in the secretion of its polymerized form. Being present on the membrane of B cells, IgM acts as the antigen-binding molecule in the antigen-antibody complex.

Because of its pentameric structure with 10 antigen-binding sites, serum IgM has a higher valency than the other isotypes. An IgM molecule can bind 10 small hapten molecules; however, because of steric hindrance, only five or fewer molecules of larger antigens can be bound simultaneously.

Treatment of serum with 2-mercaptoethanol destroys IgM without affecting IgG antibodies. This forms the basis for differential estimation of IgM and IgG antibodies in serum pretreated with 2-mercaptoethanol.

## Key Points

IgM shows the following biological activities:

- Pentameric IgM, because of its high valency, is more efficient than other isotypes in binding antigens with many repeating epitopes, such as viral particles and red blood cells.
- It is more efficient than IgG in activating complement. Complement activation requires two Fc regions in close proximity, and the pentameric structure of a single molecule of IgM fulfills this requirement.
- IgM is the first immunoglobulin produced in a primary response to an antigen. The immunoglobulin confers protection against invasion of blood by microbial pathogens. Deficiency of IgM antibodies is associated with septicemia.
- IgM antibodies are short lived and disappear early as compared to IgG. The presence of IgM antibody in serum, therefore, indicates recent infection.
- It is also the first immunoglobulin to be synthesized by a neonate in about 20 weeks of age. IgM is not transported across the placenta; hence, the presence of IgM in the fetus or newborn indicates intrauterine infection. The detection of IgM antibodies in serum, therefore, is useful for the diagnosis of congenital infections, such as syphilis, rubella, toxoplasmosis, etc.

## Immunoglobulin A

IgA is the second major serum immunoglobulin, comprising nearly 10–15% of serum immunoglobulin. It has a half-life of 6–8 days (Table 13-2).

IgA consist of  $\alpha$  heavy chain that confers class specificity on IgA molecules. The  $\alpha$  chain is a 58-kDa, 470-amino acid residue heavy polypeptide chain. The chain is divisible into three constant domains, designated CH1, CH2, and CH3, and one variable domain, designated VH. Hinge region is situated between CH1 and CH2 domains. An additional segment of 18-amino acid residues at the penultimate position of the chain contains a cysteine residue where the J chain can be attached through a disulfide bond. IgA occurs in two forms: serum IgA and secretory IgA.

**Serum IgA:** It is present in the serum and is a monomeric 7S molecule with a molecular weight of 60,000 Da. It has a half-life of 6–8 days. It has two subclasses, IgA1 and IgA2, which are two  $\alpha$ -chain isotypes  $\alpha$ -1 and  $\alpha$ -2, respectively. The  $\alpha$ -2 chain has two allotypes, A2m (1) and A2m (2), and does not have disulfide bonds linking heavy to light chains. Differences in the two  $\alpha$  chains are found in two CH1 and five CH3 positions. Thus, there are three varieties of  $\alpha$ -heavy chains in humans.

**Secretory IgA:** It is a dimer or tetramer and consists of a J-chain polypeptide and a polypeptide chain called secretory component, or SC, or secretory piece (Fig. 13-3). The SC is a polypeptide with a molecular weight of 70,000 Da and is produced by epithelial cells of mucous membranes. It consists of five immunoglobulin-like domains that bind to the Fc region domains of the IgA dimer. This interaction is stabilized by a disulfide bond between the fifth domain of the SC and one

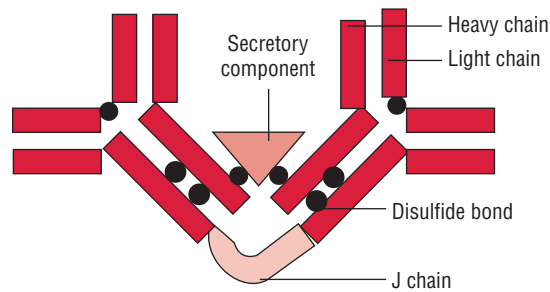

**FIG. 13-3.** Schematic diagram of immunoglobulin A (IgA).

of the chains of the dimeric IgA. IgA-secreting plasma cells are concentrated along mucous membrane surfaces. The daily production of secretory IgA is greater than that of any other immunoglobulin. Secretory IgA is the major immunoglobulin present in external secretions, such as breast milk, saliva, tears, and mucus of the bronchial, genitourinary, and digestive tracts. IgA activates the complement not by classical pathway but by alternative pathway.

### Key Points

Secretory IgA shows the following biological activities:

- It protects the mucous membranes against microbial pathogens. It serves an important effector function at mucous membrane surfaces, which are the main entry sites for most pathogenic organisms. Because it is polymeric, secretory IgA can cross-link large antigens with multiple epitopes.
- Binding of secretory IgA to bacterial and viral surface antigens prevents attachment of the pathogens to the mucosal cells, thus inhibiting viral infection and bacterial colonization. Complexes of secretory IgA and antigen are easily entrapped in mucus and then eliminated by the ciliated epithelial cells of the respiratory tract or by peristalsis of the gut.
- Breast milk contains secretory IgA and many other molecules that protect the newborns against infection during the first month of life. Because the immune system of infants is not fully functional, breast-feeding plays an important role in maintaining the health of newborns.
- Secretory IgA has shown to provide an important line of defense against bacteria (such as *Salmonella* spp., *Vibrio cholerae*, and *Neisseria gonorrhoeae*) and viruses (such as polio, influenza, and reovirus).

### ▶ Immunoglobulin E

IgE constitutes less than 1% of the total immunoglobulin pool. It is present in serum in a very low concentration (0.3  $\mu\text{g}/\text{mL}$ ). It is mostly found extravascularly in lining of the respiratory and intestinal tracts. IgE is an 8S molecule with a molecular weight of 190,000 Da and half-life of 2–3 days. Unlike other immunoglobulins that are heat stable, IgE is a heat-labile protein—easily inactivated at 56°C in 1 hour (Table 13-2).

Two  $\epsilon$  heavy polypeptide chains, along with two  $\kappa$  or two  $\lambda$  light chains, fastened together by disulfide bonds, comprise

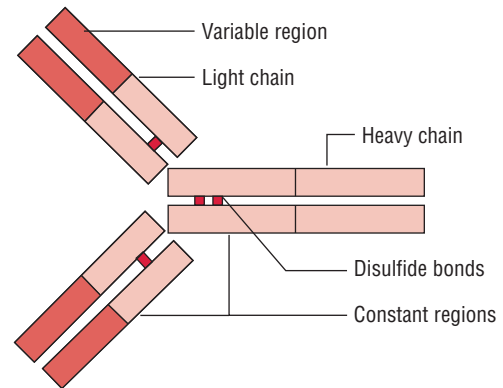

**FIG. 13-4.** Schematic diagram of immunoglobulin E (IgE).

an IgE molecule. The  $\epsilon$  chain is a 72-kDa, 550-amino acid residue polypeptide chain. It consists of one variable region, designated  $VH$ , and a four-domain constant region, designated  $CH_1$ ,  $CH_2$ ,  $CH_3$ , and  $CH_4$ . This heavy chain does not possess a hinge region. In humans, the  $\epsilon$  heavy chain has 428 amino acid residues in the constant region (Fig. 13-4). IgE does not cross the placenta or fix the complement.

### Key Points

IgE shows the following biological activities:

- IgE is also known as reaginic antibody that mediates the type I immediate hypersensitivity (atopy) reactions.
- IgE is responsible for the symptoms of hay fever, asthma, and anaphylactic shock. IgE binds to Fc receptors on the membranes of blood basophils and tissue mast cells. Cross-linkage of receptor bound IgE molecules by antigen (allergen) induces basophils and mast cells to translocate their granules to the plasma membrane and release their contents to the extracellular environment—a process known as degranulation. As a result, varieties of pharmacologically active mediators are released and give rise to allergic manifestations.
- Localized mast-cell degranulation induced by IgE may also release mediators that facilitate a buildup of various cells necessary for antiparasitic defense.

### ▶ Immunoglobulin D

IgD comprises less than 1% of serum immunoglobulins. It is a 7S monomer with a molecular weight of 180,000 Da. The half-life of IgD is only 2–3 days (Table 13-2). IgD has the basic four-chain monomeric structure with two  $\delta$  heavy chains (molecular weight 63,000 Da each) and either two  $\kappa$  or two  $\lambda$  light chains (molecular weight 22,000 Da each) (Table 13-2).

Immunoglobulin  $\delta$  chain is a 64-kDa, 500-amino acid residue heavy polypeptide chain consisting of one variable region, designated as  $VH$ , and a three-domain constant region, designated as  $CH_1$ ,  $CH_2$ , and  $CH_3$ . There is also a 58-residue amino acid residue hinge region in human  $\delta$  chains. Two exons encode the hinge region. IgD is very susceptible to the action of proteolytic enzymes at its hinge region. Two separate exons

TABLE 13-3

Role of immunoglobulins in human defense

IgG	IgM	IgA	IgD	IgE
Enhances phagocytosis	Especially effective against microorganisms and agglutinating antigens	Localized protection on mucosal surfaces	Serum function not known	Allergic reaction
Neutralizes toxins and viruses	First antibody produced in response to initial infection		Present on B cells; and function in initiation of immune response	Possibly lysis of parasitic worms
Protects fetus and newborn				

encode the membrane component of  $\delta$  chain. A distinct exon encodes the carboxy terminal portion of the human  $\delta$  chain that is secreted. The human  $\delta$  chain contains three N-linked oligosaccharides.

Table 13-3 summarizes roles of various immunoglobulins in human defense.

### Key Points

IgD is present on the surface of B lymphocytes and both IgD and IgM serve as recognition receptors for antigens. The role of IgD in immunity continues to remain elusive.

## Abnormal Immunoglobulins

Abnormal immunoglobulins are other structurally similar proteins that are found in serum in certain pathological conditions, such as multiple myeloma, heavy chain disease, and cryoglobulinemia and sometimes in healthy individuals also.

**Multiple myeloma:** Bence-Jones (BJ) proteins were the earliest abnormal proteins described in 1847 that were found in patients with multiple myeloma. These proteins are the light chains of immunoglobulins, hence occur as either  $\kappa$  or  $\lambda$  forms. In a patient, it may occur as either  $\kappa$  or  $\lambda$  but never in both the forms. BJ proteins have a peculiar property of coagulating at 60°C and redissolving again at a higher temperature of 80°C.

In multiple myeloma, plasma cells synthesizing IgG, IgA, IgD, or IgE are affected. Myeloma involving IgM-producing plasma cells is known as *Waldenström's macroglobulinemia*. This condition is characterized by excessive production of the respective myeloma proteins (M proteins) and that of their light chains (BJ proteins).

The study of myeloma proteins led to a great advancement in our understanding of immunoglobulin function. These "single" or "monoclonal" antibodies obtained from the sera of patients with multiple myeloma were used in many of the serologic and biochemical studies of the 1950s and 1960s. They remained the major source of homogeneous immunoglobulins until the development of the hybridoma in 1974. The serologists injected them into animals and produced antisera that were used to study some of the basic properties of antibodies. For example, the immune sera were absorbed with other myeloma proteins and were used to identify isotypic, allotypic, and idiotypic specificities.

**Heavy chain disease:** Heavy chain disease is a different disorder, which is a lymphoid neoplasia, characterized by an excess production of heavy chains of the immunoglobulins.

**Cryoglobulinemia:** Cryoglobulinemia is a condition characterized by presence of cryoglobulins in blood. The condition may not be always associated with disease but is often found in patients with macroglobulinemia, systemic lupus erythematosus, and myelomas. Most cryoglobulins consist of either IgG or IgM or their mixed precipitates. In cryoglobulinemia, serum from patient precipitates on cooling and redissolves on warming.

# Antigen–Antibody Reactions

## Introduction

The interactions between antigens and antibodies are known as **antigen–antibody reactions**. The reactions are highly specific, and an antigen reacts only with antibodies produced by itself or with closely related antigens. Since these reactions are essentially specific, they have been used in many diagnostic tests for the detection of either the antigen or the antibody *in vitro*. The antigen and antibody reactions also form the basis of immunity against microbial diseases *in vivo*. In the host, it may cause tissue injury in hypersensitivity reactions and in autoimmune diseases.

## General Features of Antigen–Antibody Reactions

Antigen and antibody bind through noncovalent bonds in a manner similar to that in which proteins bind to their cellular receptors, or enzymes bind to their substrates. But antigen–antibody reactions differ from the latter as there is no irreversible chemical alteration in either of the participants, i.e., antigen or the antibody. The antigen and antibody binding is reversible and can be prevented or dissociated by high ionic strength or extreme pH. Following are some of the general features of these interactions:

### Physicochemical Properties

Electrostatic bonds, hydrogen bonding, van der Waals bonds, and hydrophobic interactions are the intermolecular forces involved in antigen–antibody reactions. All these types of intermolecular forces depend on the close proximity of the antigen and antibody molecules. For that reason, the “good fit” between an antigenic determinant and an antibody-combining site determines the stability of the antigen–antibody reaction. Multiple bonding between the antigen and the antibody ensures that the antigen will be bound tightly to the antibodies.

### Affinity

Affinity denotes the intensity of attraction between antigen and antibody.

- Low-affinity antibodies bind antigen weakly and tend to dissociate readily, whereas high-affinity antibodies bind antigen more tightly and remain bound longer.

- High-affinity binding is believed to result from a very close fit between the antigen-binding sites and the corresponding antigenic determinants that facilitates development of strong noncovalent interactions between antigen and antibody.

### Avidity

Avidity is a measure of the overall strength of binding of an antigen with many antigenic determinants and multivalent antibodies. Avidity is a better indicator of the strength of interactions in real biological systems than affinity. Therefore, the avidity of an antigen–antibody reaction is dependent on the valencies of both antigens and antibodies and is greater than the sum total of individual affinities.

### Specificity

The term specificity refers to the ability of an individual antibody-combining site to react with only one antigenic determinant or the ability of a population of antibody molecules to react with only one antigen. Antigen–antibody reactions usually show a high degree of specificity.

### Key Points

Antibodies can specifically recognize differences in:

- primary structure of an antigen,
- isomeric forms of an antigen, and
- secondary and tertiary structure of an antigen.

Despite this, cross-reactions between antigens and antibodies, however, do occur and are sometimes responsible for causing diseases in hosts and for causing false results in diagnostic tests.

### Cross-Reactivity

Although antigen–antibody reactions are highly specific, in some cases antibody elicited by one antigen can cross-react with an unrelated antigen. Such cross-reactivity occurs if two different antigens share an identical or very similar epitope. In the latter case, the antibody’s affinity for the cross-reacting epitope is usually less than that for the original epitope. Antisera containing polyclonal antibodies can often be found to cross-react with immunogens partially related to those used for immunization, due to the existence of common epitopes or of epitopes with similar configurations.

## Stages of Antigen–Antibody Reactions

The antigen–antibody reaction occurs in two stages: primary and secondary.

### Primary Stage

Primary stage is the initial interaction between antigen and antibody. It is rapid and reversible, but without any visible effects. The ionic bonds, hydrogen bonds, van der Waals forces, and hydrophobic interactions are the weaker intermolecular forces that bind antigen and antibodies together in this primary stage.

Covalent binding, which is a stronger intermolecular force between antigen and antibody, however, does not occur in this stage.

### Secondary Stage

Secondary stage is an irreversible interaction between antigen and antibody, with visible effects, such as agglutination, precipitation, neutralization, complement fixation, and immobilization of motile organisms. The binding between antigen and antibody during this stage occurs by covalent binding.

A single antibody is capable of causing different types of antigen–antibody reactions, and a single antigen is capable of inducing production of different classes of immunoglobulins, which differ in their biological properties.

The results of agglutination, precipitation, neutralization, and other tests are usually expressed as a titer. **Titer** is defined as the highest dilution of serum that gives a positive reaction in

test. Higher titer means greater level of antibodies in serum. For example, a serum with a titer of 1/128 contains more antibodies than a serum with a titer of 1/8.

## Types of Antigen–Antibody Reactions

Serological tests are widely used for detection of either serum antibodies or antigens for diagnosis of a wide variety of infectious diseases (Table 14-1). These serological tests are also used for diagnosis of autoimmune diseases and in typing of blood and tissues before transplantation. The following are the examples of antigen–antibody reactions: (a) precipitation, (b) agglutination, (c) complement-dependent serological tests, (d) neutralization test, (e) opsonization, (f) immunofluorescence, (g) enzyme immunoassay, (h) radioimmunoassay, (i) western blotting, (j) chemiluminescence assay, and (k) immunoelectronmicroscopic tests.

### Precipitation

Precipitation test shows the following features:

- It is a type of antigen–antibody reaction, in which the antigen occurs in a soluble form.
- It is a test in which antibody interacts with the soluble antigen in the presence of electrolyte at a specified pH and temperature to produce a precipitate. A lattice is formed between the antigens and antibodies; in certain cases, it is visible as an insoluble precipitate.
- Antibodies that aggregate soluble antigens are called precipitins.

TABLE 14-1

Commonly used tests in clinical microbiology

Test	Uses
Flocculation test	Detection of reaginic antibodies in syphilis by VDRL test
Radial immunodiffusion	Detection of fungal antigen and antibodies
Counter-current immunoelectrophoresis	Detection of both antigen and antibodies in bacterial, viral, fungal, and parasitic diseases
Slide agglutination test	Identification of bacterial isolates, such as <i>Salmonella</i> , <i>Shigella</i> , <i>Vibrio</i> , etc.
Tube agglutination test	Detection of antibodies in bacterial infections, e.g., Widal test for enteric fever
Latex agglutination test	Quantitation and detection of antigen and antibodies
Hemagglutination test	Detection of both antigens and antibodies in viral and parasitic infections
Coagglutination test	Detection of microbial antigens
Complement fixation test	Quantitation and detection of antibodies
Direct immunofluorescence test	Detection and localization of antigen in a cell or tissue
Indirect immunofluorescence test	Detection of specific antibodies in the serum
Sandwich ELISA	Detection of antigens and antibodies
Indirect ELISA	Quantitation and detection of antibodies
Radioimmunoassay	Quantitation of hormones, drugs, etc.
Western blot	Detection of antigen-specific antibody

- When instead of sedimenting, the precipitate remains suspended as floccules, the reaction is known as **flocculation**.
- Formation of an antigen-antibody lattice depends on the valency of both the antibody and antigen.
- The antibody must be bivalent; a precipitate will not form with monovalent Fab fragments.
- The antigen must be either bivalent or polyvalent; that is, it must have at least two copies of the same epitope, or have different epitopes that react with different antibodies present in polyclonal antisera.

► **Prozone phenomenon**

Antigen and antibody reaction occurs optimally only when the proportion of the antigen and antibody in the reaction mixture is equivalent (**zone of equivalence**) (Fig. 14-1). On either side of the equivalence zone, precipitation is actually prevented because of an excess of either antigen or antibody. The zone of antibody excess is known as the **prozone phenomenon** and the zone of antigen excess is known as **postzone phenomenon**.

Marrack in 1934 proposed the *lattice hypothesis* to explain the prozone phenomenon. Marrack's hypothesis is based on the assumptions that each antibody molecule must have at least two binding sites, and antigen must be multivalent. In the zone of equivalence where optimum precipitation occurs, the number of multivalent sites of antigen and antibody are approximately equal. In this zone, precipitation occurs as a result of random, reversible reactions whereby each antibody binds to more than one antigen and vice versa, forming a stable network or lattice. As they combine, it results in a multimolecular lattice that increases in size until it precipitates out of solution.

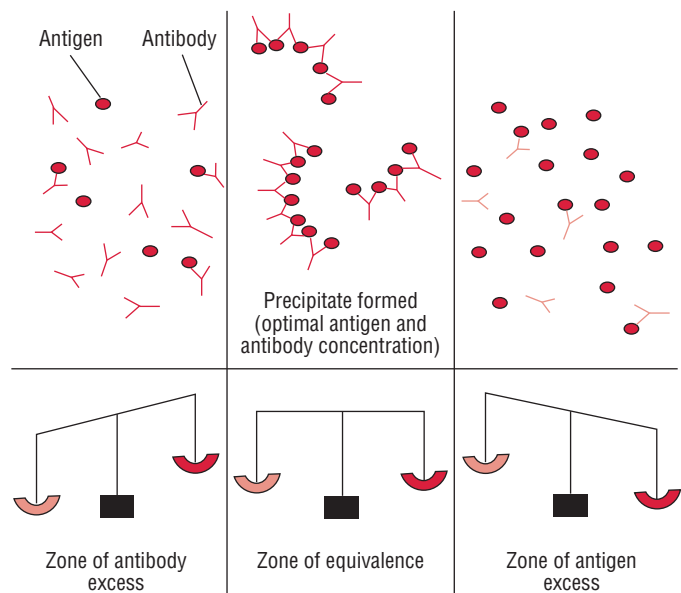

FIG. 14-1. Prozone phenomenon.

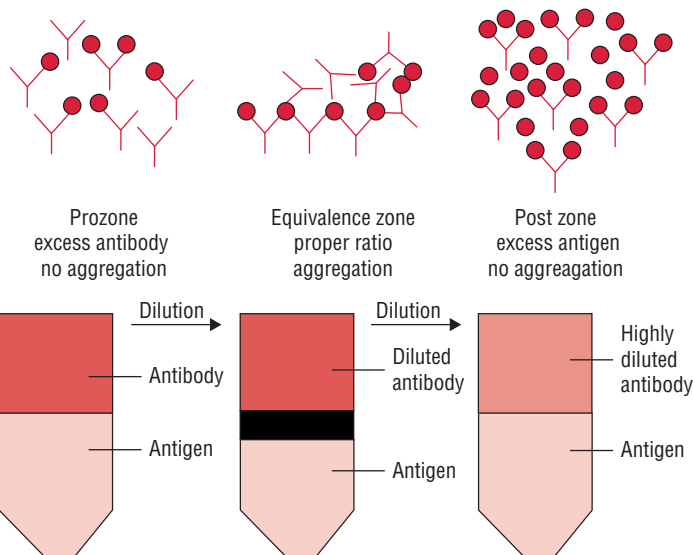

FIG. 14-2. Marrack's lattice hypothesis.

**Key Points**

- In the prozone phenomenon, there is too much antibody for efficient lattice formation. This is because antigen combines with only few antibodies and no cross-linkage is formed.
- In postzone phenomenon, small aggregates are surrounded by excess antigen and again no lattice network is formed.
- Thus, for precipitation reactions to be detectable, they must be run in the zone of equivalence (Fig. 14-2).

The prozone and postzone phenomena are taken into consideration in the interpretation of serological tests, because false negative reactions can occur in either of these conditions. A false negative reaction suspected to be due to prozone phenomenon can be rectified by diluting out the antibody and performing the test. In the postzone phenomenon, excess antigen may obscure the presence of small amount of antibodies. Typically, such a test is repeated with an additional patient specimen taken about a week later. This would give time for the further production of antibodies. If the test is negative on this occasion, it is unlikely that the patient has that particular antibody.

► **Types of precipitation reactions**

Precipitation reactions can be broadly of three types:

1. Precipitation in solution
2. Precipitation in agar
3. Precipitation in agar with an electric field

**Precipitation in solution**

Ring test and flocculation test are examples of precipitation in solution.

- **Ring test:** In this test, antigen solution is layered over antiserum in a test tube. Precipitation between antigen and antibodies in antiserum solution is marked by the appearance of a ring of precipitation at the junction of two liquid layers. C-reactive protein (CRP) and streptococcal grouping by the Lancefield methods are the examples of the ring test.
- **Flocculation test:** Flocculation test may be performed in a slide or tube. VDRL test for detection of reaginic antibodies in syphilis is an example of a *slide flocculation test*. In this test, a drop of VDRL antigen suspension is added to a drop of patients' serum on a cavity slide, and the result is recorded after shaking the slide on a VDRL shaker. In a positive test, the floccules appear, which can be demonstrated well under a microscope. Kahn test for syphilis is an example of *tube flocculation test*. The tube flocculation test for standardization of toxins and toxoids is another example.

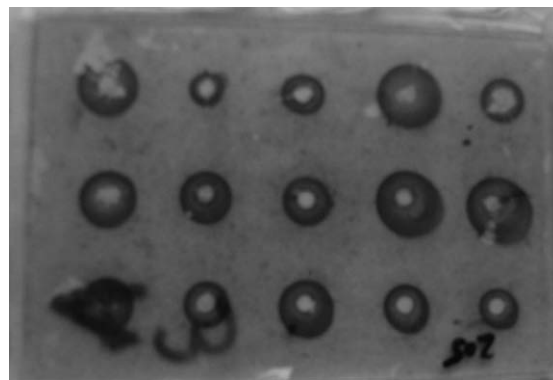

FIG. 14-3. Radial immunodiffusion.

the surface of gel. The antigen is then applied to a well cut into the gel. When antibody already present in the gel reacts with the antigen, which diffuses out of the well, a ring of precipitation is formed around the wells. The diameter of the ring is directly proportional to the concentration of antigen. The greater the amount of antigen in the well, the farther the ring will be from the well (Fig. 14-3, Color Photo 6).

### Key Points

Radial immunodiffusion has been used for the quantitative estimation of antibodies and antigens in the serum. It is used to measure:

- IgG, IgM, IgA, and complement components in the serum,
- antibodies to influenza virus in sera, and
- serum transferrin and  $\alpha$ -fetoprotein.

However, the test has recently been replaced by more sensitive and automated methods, such as nephelometry and enzyme-linked immunosorbent assays (ELISAs).

- **Double diffusion in one dimension:** This method is also called *Oakley-Fulthrope procedure*. In this method, the antibody is incorporated in agar gel in a test tube, above which a layer of plain agar is placed. The antigen is then layered on top of this plain agar. During the course of time, the antigen and antibody move toward each other through the intervening layer of plain agar. In this zone of plain agar, both antigen and antibody react with each other to form a band of precipitation at their optimum concentration.
- **Double diffusion in two dimensions:** This method is also called the *Ouchterlony procedure*. In this method, both the antigen and antibody diffuse independently through agar gel in two dimensions, horizontally and vertically. The test is performed by cutting wells in the agar gel poured on a glass slide or in a Petri dish. The antiserum consisting of antibodies is placed in the central well, and different antigens are added to the wells surrounding the center well. After an incubation period of 12–48 hours in a moist chamber, the lines of precipitins are formed at the sites of combination of antigens and antibodies (Color Photo 7). Three types of reactions can be demonstrated as follows (Fig. 14.4):

### Precipitation in agar

The precipitation test in agar gel is termed as *immunodiffusion* test. In this test, reactants are added to the gel and antigen-antibody combination occurs by means of diffusion. The rate of diffusion is affected by the size of the particles, temperature, gel viscosity, amount of hydration, and interactions between the matrix and reactants.

An agar concentration of 0.3–1.5% allows for diffusion of most reactants. Agarose is often preferred to agar because agar has a strong negative charge, while agarose has almost none, so that interactions between the gel and reactants are minimized.

### Key Points

Immunodiffusion reactions have the following advantages:

- In this test, the line of precipitation is visible as a band, which can also be stained for preservation.
- The test can be used to detect identity, cross-reaction, and nonidentity between different antigens in a reacting mixture.

**Types of immunodiffusion reactions:** Immunodiffusion reactions are classified based on the (a) number of reactants diffusing and (b) direction of diffusion, as follows:

- **Single diffusion in one dimension:** Single diffusion in one dimension, as the name suggests, is the single diffusion of antigen in agar in one dimension. It is otherwise called *Oudin procedure* because this technique was pioneered by Oudin who for the first time used gels for precipitation reactions. In this method, antibody is incorporated into agar gel in a test tube and the antigen solution is poured over it. During the course of time, the antigen diffuses downward toward the antibody in agar gel and a line of precipitation is formed. The number of precipitate bands shows the number of different antigens present in the antigen solution.
- **Single diffusion in two dimensions:** Single diffusion in two dimensions is also called *radial immunodiffusion*. In this method, antiserum solution containing antibody is incorporated in agar gel on a slide or Petri dish. The wells are cut on



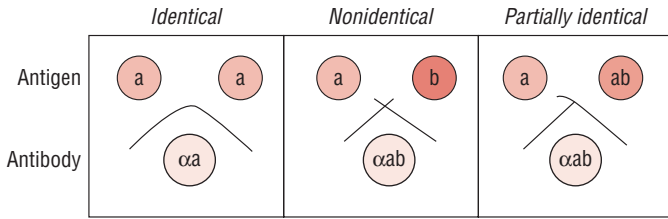

FIG. 14-4. Ouchterlony procedure.

1. Line of precipitation at their junction forming an arc represents serologic identity or the presence of a common epitope in antigens.
2. A pattern of crossed lines demonstrates two separate reactions and indicates that the compared antigens are unrelated and share no common epitopes.
3. Fusion of two lines with a spur indicates cross-reaction or partial identity. In this last case, the two antigens share a common epitope, but some antibody molecules are not captured by the antigen and traverse through the initial precipitin line to combine with additional epitopes found in the more complex antigen.

### Key Points

Double diffusion in two dimension has been used for:

- demonstration of antibodies in serodiagnosis of small pox,
- identification of fungal antigens, and
- detection of antibodies to extractable nuclear antigens.

Elek's precipitation test in gel is a special test used for demonstration of toxigenicity of *Corynebacterium diphtheriae*.

### Precipitation in agar with an electric field

**Immunoelectrophoresis:** Immunoelectrophoresis is a process of combination of immunodiffusion and electrophoresis. It is a method in which different antigens in serum are separated according to their charge under an electric field. In this method, a drop of antigen is placed into a well in agar on a glass slide. An electric current is then passed through the agar. During electrophoresis, antigens move in the electric field according to their charge and size. Following electrophoresis, a trough is cut into the agar and is filled with the antibody and diffusion is allowed to occur. As the antigen and antibody diffuse toward each other, they form a series of lines of precipitation (Fig. 14-5). The main advantage of immunoelectrophoresis is that a number of antigens can be identified in serum. The method is used to detect normal as well as abnormal proteins, such as myeloma proteins in human serum.

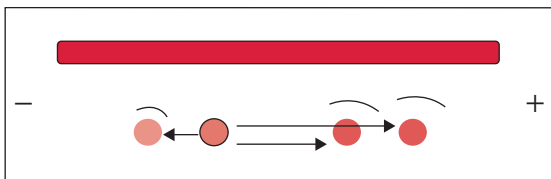

FIG. 14-5. Immunoelectrophoresis.

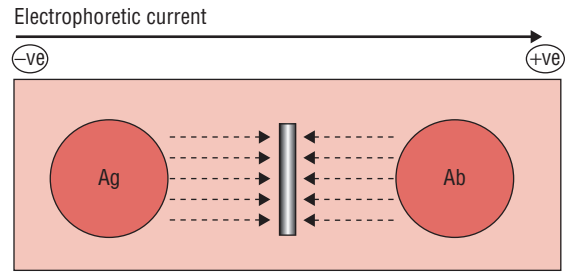

FIG. 14-6. Counter-current immunoelectrophoresis.

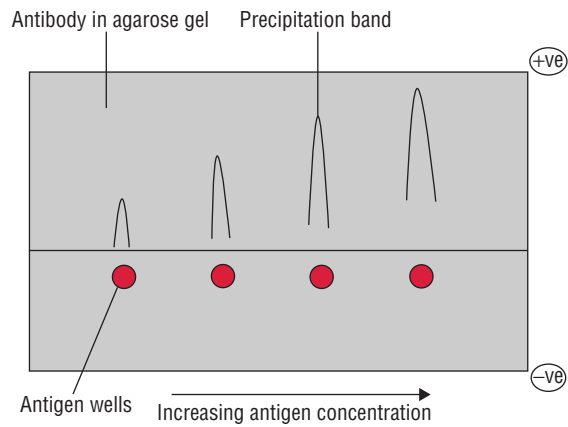

FIG. 14-7. Rocket electrophoresis.

**Counter-current immunoelectrophoresis:** Counter-current immunoelectrophoresis depends on movement of antigen towards the anode and of antibody towards the cathode through the agar under electric field. The test is performed on a glass slide with agarose in which a pair of wells is punched out. One well is filled with antigen and the other with antibody. Electric current is then passed through the gel. The migration of antigen and antibody is greatly facilitated under electric field, and the line of precipitation is made visible in 30–60 minutes (Fig. 14-6).

### Key Points

The counter-current immunoelectrophoresis has many uses:

- It is a rapid and a highly specific method for detection of both antigen and antibodies in the serum, cerebrospinal fluid, and other body fluids in diagnosis of many infectious diseases including bacterial, viral, fungal, and parasitic.
- It is commonly used for Hepatitis B surface antigen (HBsAg), α-fetoprotein, hydatid and amoebic antigens in the serum, and cryptococcal antigen in the CSF.

**Rocket electrophoresis:** This technique is an adaptation of radial immunodiffusion developed by Laurell. It is called so due to the appearance of the precipitin bands in the shape of cone-like structures (rocket appearance) at the end of the reaction (Fig. 14-7, Color Photo 8). In this method, antibody is incorporated in the gel and antigen is placed in

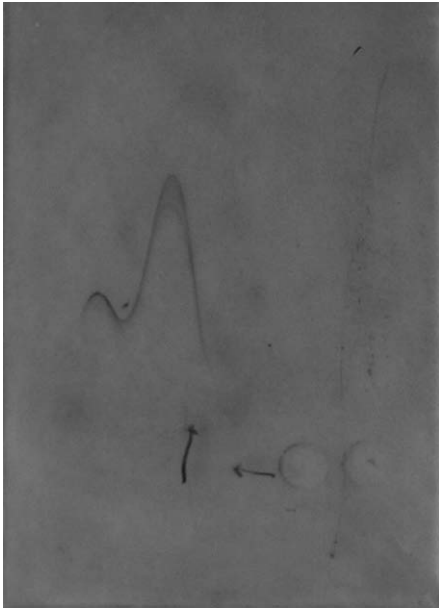

**FIG. 14-8.** Photograph of rocket electrophoresis.

wells cut in the gel. Electric current is then passed through the gel, which facilitates the migration of antigen into the agar. This results in formation of a precipitin line that is conical in shape, resembling a rocket. The height of the rocket, measured from the well to the apex, is directly in proportion to the amount of antigen in the sample (Fig. 14-8). Rocket electrophoresis is used mainly for quantitative estimation of antigen in the serum.

**Two-dimensional immunoelectrophoresis:** Two-dimensional immunoelectrophoresis is a variant of rocket electrophoresis. It is a double diffusion technique used for qualitative as well as quantitative analysis of sera for a wide range of antigens. This test is a two-stage procedure. In the first stage, antigens in solution are separated by electrophoresis. In the second stage, electrophoresis is carried out again, but perpendicular to that of first stage to obtain rocket-like precipitation.

In this test, first, a small trough is cut in agar gel on a glass plate and is filled with the antigen solution. Electric current is then passed through the gel, and the antigens migrate into the gel at a rate proportional to their net electric charge. In the second stage, after electrophoresis, the gel piece containing the separated antigens is placed on a second glass plate and the agar containing antibody is poured around the gel piece. A second electric potential is applied at right angles to the first direction of migration. The pre-separated antigens then migrate into the gel containing antibodies at a rate proportional to their net charge and precipitate with antibodies in the gel, forming precipitates.

This method is both qualitative, in that it identifies different antigens that are present in the serum solution, and quantitative, in that it detects the amount of different antigens present in the solution.

**Turbidimetry and nephelometry:** Turbidimetry and nephelometry are the two methods used to detect and quantitate precipitation reactions in serum and are based on the

phenomenon of light scattering by precipitates in a solution. **Turbidimetry** is a measurement of turbidity or cloudiness of precipitate in a solution. In this method, a detection device is placed in direct line with the incident light that collects the light after it has passed through the solution. It thus measures the reduction in the intensity of light due to reflection, absorption, or scatter. Scattering of light occurs in proportion to the size, shape, and concentration of precipitates present in solution.

**Nephelometry** is an improvement on this technique in that it measures the light that is scattered at a particular angle from the incident beam as it passes through a suspension containing the antigen-antibody precipitate. The amount of light scattered is an index of the concentration of the solution. Beginning with a constant amount of antibody, an increasing amount of antigen would result in an increase in antigen-antibody complexes. Thus the relationship between antigen concentrations, as indicated by the antigen-antibody complex formation, and light scattering approaches linearity. By using a computer, the exact values of the antigen or antibody in the serum can be estimated through this system. To improve the sensitivity of this system, laser beams have been used as the source of incident light.

### Key Points

Nephelometry is now becoming the method of choice for use in various laboratories for the measurement of plasma proteins including IgG, IgM, and IgA, complement components, RA (rheumatoid arthritis) factor, ASLO (anti-streptolysin O), etc.

### Agglutination

Agglutination is an antigen-antibody reaction in which a particulate antigen combines with its antibody in the presence of electrolytes at a specified temperature and pH resulting in formation of visible clumping of particles. Agglutination occurs optimally when antigens and antibodies react in equivalent proportions.

- Agglutination reactions are mostly similar to precipitation reactions in their fundamentals and share similar features. This reaction is analogous to the precipitation reaction in that antibodies act as a bridge to form a lattice network of antibodies and the cells that carry the antigen on their surface. Because cells are so much larger than a soluble antigen, the result is more visible when the cells aggregate into clumps.
- Agglutination differs from precipitation reaction in that since the former reaction takes place at the surface of the particle involved, the antigen must be exposed and be able to bind with the antibody to produce visible clumps.

In agglutination reactions, serial dilutions of the antibody solution are made and a constant amount of particulate antigen is added to serially diluted antibody solutions. After several hours of incubation at 37°C, clumping is recorded by visual inspection. The titer of the antiserum is recorded

as the reciprocal of the highest dilution that causes clumping. Since the cells have many antigenic determinants on their surface, the phenomenon of antibody excess is rarely encountered.

Occasionally, antibodies are formed that react with the antigenic determinants of a cell but does not cause any agglutination. They inhibit the agglutination by the complete antibodies added subsequently. Such antibodies are called **blocking antibodies**. Anti-Rh antibodies and anti-brucella antibodies are few examples of such blocking antibodies.

Agglutination reactions have a wide variety of applications in the detection of both antigens and antibodies in serum and other body fluids. They are very sensitive and the result of the test can be read visually with ease.

### Types of agglutination reactions

Agglutination reactions where the antigens are found naturally on a particle are known as direct agglutination. This is different from passive agglutination, which employs particles that are coated with antigens not normally found on their surfaces.

#### Direct agglutination

Direct agglutination reactions can broadly be of the following types: (a) slide agglutination, (b) tube agglutination, (c) heterophile agglutination, and (d) antiglobulin (Coombs') test.

**Slide agglutination test:** It is a basic type of agglutination reaction that is performed on a slide. Identification of bacterial types represents a classic example of a direct slide agglutination that is still used today. In this test, a suspension of bacteria is prepared and is added to a drop of standardized antiserum. A positive reaction is indicated by clumping of bacteria and clearing of the background solution. Clumping occurs instantly or within seconds in a positive test. A control consisting of antigen suspension in saline without adding antiserum is included on the same slide. It is used to validate the results and also to detect possible false positives due to autoagglutination of the antigen.

#### Key Points

Slide agglutination is used:

- As a routine procedure to identify bacterial strains, such as *Salmonella*, *Shigella*, *Vibrio*, etc., isolated from clinical specimens.
- For blood grouping and cross-matching.

**Tube agglutination test:** Tube agglutination test, as the name suggests, is performed in glass tubes. Typically, in these tests, patient's serum is diluted in a series of tubes and bacterial antigens specific for the suspected disease are added to it. Antigen and antibody reactions are demonstrated by demonstration of visible clumps of agglutination. It is a standard method used for quantitative estimation of antibodies in the serum. Tube agglutination tests are routinely used for demonstration of antibodies in the serum for serodiagnosis of enteric fever and brucellosis, as follows:

#### Key Points

- Widal test is used to diagnose enteric fever and uses different *Salmonella* antigens ( $T_{O}$ ,  $T_{H}$ ,  $A_{H}$ , and  $B_{H}$ ) to detect the presence of antibodies to *Salmonella typhi*, *S. paratyphi A*, and *S. paratyphi B* in patient's serum.
- The standard agglutination test is a commonly used test for serodiagnosis of brucellosis. The tube agglutination test for brucellosis, however, is complicated by the prozone phenomenon. This is due to high concentration of brucella antibodies in patient's serum, resulting in false negative reactions. This problem is obviated by use of several dilutions of serum to prevent false positive reactions. The presence of blocking or incomplete antibodies in the serum is another problem. This is avoided by using antiglobulin (Coombs' test) to detect these antibodies.

**Heterophile agglutination test:** This test depends on demonstration of heterophilic antibodies in serum present in certain bacterial infections:

#### Key Points

- Weil-Felix test is an example of heterophile agglutination reaction for serodiagnosis of rickettsial infections. In this test, the cross-reacting antibodies produced against rickettsial pathogen are detected by using cross-reacting related antigens (e.g., *Proteus* strains OXK, OX19, and OX2). Although the antibodies are produced against rickettsial organisms, they cross-react with antigens of *Proteus* strains OXK, OX19, and OX2.
- Paul-Bunnell test is another heterophile agglutination test, which is used to detect antibodies in infectious mononucleosis by using sheep erythrocytes as antigens.
- *Streptococcus MG* agglutination test is a similar test used for detection of antibodies to *Mycoplasma pneumoniae* causing primary atypical pneumonia.

**Antiglobulin (Coombs') test:** Coombs' test was devised originally by Coombs', Mourant, and Race for detection of incomplete anti-Rh antibodies that do not agglutinate Rh+ erythrocytes in saline. When serum containing incomplete anti-Rh antibodies is mixed with Rh+ erythrocytes in saline, incomplete antibody antiglobulin coats the surface of erythrocytes but does not cause any agglutination. When such erythrocytes are treated with antiglobulin or Coombs' serum

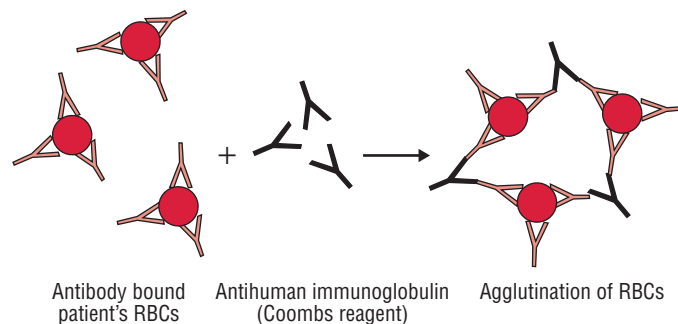

FIG. 14-9. Principle of the direct Coombs' test.

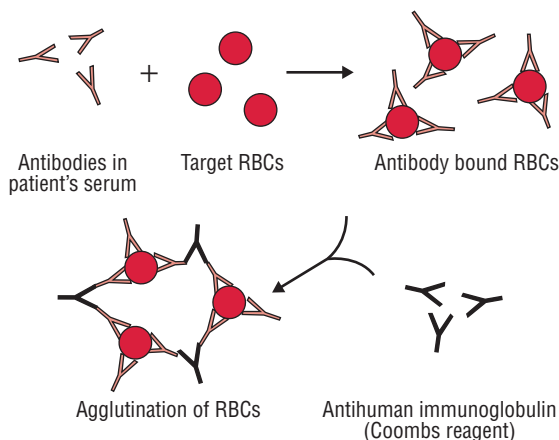

FIG. 14-10. Principle of the indirect Coombs' test.

(rabbit antiserum against human  $\gamma$  globulin), then the cells are agglutinated. Coombs' test is of two types: (a) direct Coombs' test and (b) indirect Coombs' test.

- **Direct Coombs' test:** In this test, the sensitization of red blood cells (RBCs) with incomplete antibodies takes place *in vivo*. The cell-bound antibodies can be detected by this test in which antiserum against human immunoglobulin is used to agglutinate patient's red cells (Fig. 14-9).
- **Indirect Coombs' test:** In this test, the sensitization of RBCs with incomplete antibodies takes place *in vitro*. In this test, the patient's serum is mixed with normal red cells and antiserum to human immunoglobulin is added. Agglutination occurs if antibodies are present in the patient's serum (Fig. 14-10).

Coombs' tests are used for detection of (a) anti-Rh antibodies and (b) incomplete antibodies in brucellosis and other diseases.

### Passive agglutination

Passive agglutination employs carrier particles that are coated with soluble antigens. This is usually done to convert precipitation reactions into agglutination reactions, since the latter are easier to perform and interpret and are more sensitive than precipitation reactions for detection of antibodies. When the antibody instead of antigens is adsorbed on the carrier particle for detection of antigens, it is called **reverse passive agglutination**.

Until the 1970s, erythrocytes were the major carrier particles used for coating of antigens. Recently, however, a variety of other particles including polystyrene latex, bentonite, and charcoal are used for this purpose. Particle size vary from  $7\ \mu$  for RBCs to  $0.05\ \mu$  for very fine latex particles. The use of synthetic beads or particles provides the advantage of consistency, uniformity, and stability. Reactions are also easy to read visually. Passive agglutination reaction, depending on the carrier particles used, can be of the following types: (i) latex agglutination test, (ii) hemagglutination test, and (iii) coagglutination test.

**Latex agglutination test:** It is a test that employs latex particles as carrier of antigen or antibodies. In 1955, Singer and Plotz accidentally found that IgG was naturally adsorbed to the surface of polystyrene latex particles.

Latex particles are inexpensive, relatively stable and are not subject to cross-reactivity with other antibodies. These particles can be coated with antibodies to detect antigen in the serum and other body fluids. Use of monoclonal antibodies has reduced the cross-reactions resulting in reduction of false positive reactions.

Additionally, the large particle size of the latex facilitates better visualization of antigen-antibody reactions by the naked eye observation. The tests are usually performed on cardboard cards or glass slides and positive reactions are graded on a scale of 1+ to 4+.

### Key Points

The latex agglutination tests have following uses:

- The tests are used for rapid identification of antigens of group B *Streptococcus*, *Staphylococcus aureus*, *Neisseria meningitidis*, *Cryptococcus neoformans*, etc.
- The tests have also been found to be useful for detection of soluble microbial antigens in urine, spinal fluid, and serum for diagnosis of a variety of infectious diseases.
- These tests are being used to detect RA factor, ASLO, CRP, etc., in serum specimens.

**Hemagglutination test:** RBCs are used as carrier particles in hemagglutination tests. RBCs of sheep, human, chick, etc. are commonly used in the test. When RBCs are coated with antigen to detect antibodies in the serum, the test is called **indirect hemagglutination (IHA) test**. The IHA is a most commonly used test for serodiagnosis of many parasitic diseases including amoebiasis, hydatid disease, and toxoplasmosis.

When antibodies are attached to the RBCs to detect microbial antigen, it is known as **reverse passive hemagglutination (RPHA)**. The RPHA has been used extensively in the past to detect viral antigens, such as in HBsAg in the serum for diagnosis of hepatitis B infection. The test has also been used for detection of antigens in many other viral and parasitic infections.

**Viral hemagglutination:** Many viruses including influenza, mumps, and measles have the ability to agglutinate RBCs without antigen-antibody reactions. This process is called viral hemagglutination. This hemagglutination can be inhibited by antibody specifically directed against the virus, and this phenomenon is called **hemagglutination inhibition**. This forms the basis of the viral hemagglutination inhibition test, which is used to detect antibodies in patient's sera that neutralize the agglutinating viruses. To perform this test, patient's serum is first incubated with a viral preparation. Then RBCs that the virus is known to agglutinate are added to the mixture. If antibody is present, this will combine with viral particles and prevent

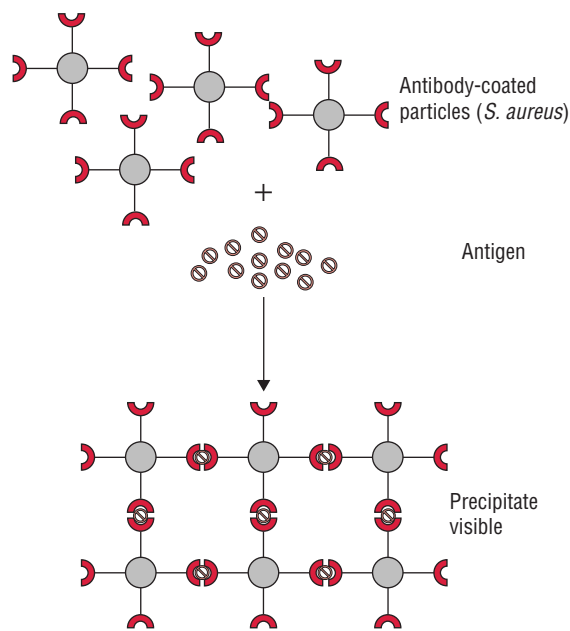

FIG. 14-11. Principle of the coagglutination.

agglutination, and a lack of or reduction in agglutination indicates presence of antibody in patient's serum.

**Coagglutination test:** Coagglutination is a type of agglutination reaction in which Cowan I strain of *S. aureus* is used as carrier particle to coat antibodies. Cowan I strain of *S. aureus* contains protein A, an anti-antibody, that combines with the Fc portion of immunoglobulin, IgG, leaving the Fab region free to react with the antigen present in the specimens (Fig. 14-11). In a positive test, protein A bearing *S. aureus* coated with antibodies will be agglutinated if mixed with specific antigen. The advantage of the test is that these particles show greater stability than latex particles and are more refractory to changes in ionic strength.

## Key Points

Coagglutination test has been used for:

- Detection of cryptococcal antigen in the CSF for diagnosis of cryptococcal meningitis;
- Detection of amoebic and hydatid antigens in the serum for diagnosis of amoebiasis and cystic echinococcosis, respectively; and
- Grouping of streptococci and mycobacteria and for typing of *Neisseria gonorrhoeae*.

## Complement-Dependent Serological Tests

The complement system is a group of serum proteins that is present in normal serum. The system consists of 20 or more serum proteins that interact with one another and with cell membrane. It is a biochemical cascade that helps to clear pathogens from the body. It aids the antibodies in lysing bacteria,

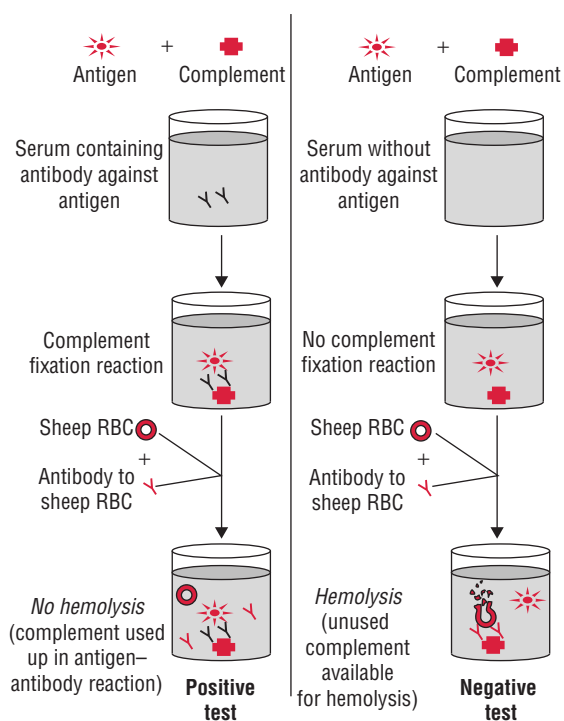

FIG. 14-12. Complement fixation test.

promoting phagocytosis, and in immune adherence. The complement-dependent serological tests may be of the following types:

1. Complement fixation test
2. Immune adherence test
3. Immobilization test
4. Cytolytic or cytotoxic reactions

### ► Complement fixation test

The principle of the complement fixation test is that when antigen and antibodies of the IgM or the IgG classes are mixed, complement is "fixed" to the antigen-antibody complex. If this occurs on the surface of RBCs, the complement cascade will be activated and hemolysis will occur. The complement fixation test consists of two antigen-antibody complement systems: (a) an indicator system and (b) a test system.

**Indicator system:** It consists of RBCs that have been preincubated with a specific anti-RBC antibody, in concentrations that do not cause agglutination, and no hemolysis of RBCs occurs in the absence of complement. Such RBCs are designated as "sensitized" red cells.

**Test system:** In the test system, patient's serum is first heated to 56°C to inactivate the native complement. Then the inactivated serum is adsorbed with washed sheep RBC to eliminate broadly cross-reactive anti-RBC antibodies (also known as Forssman-type antibodies), which could interfere with the assay. The serum is then mixed with purified antigen and with a dilution of fresh guinea pig serum, used as source of

complement. The mixture is incubated for 30 minutes at 37°C to allow antibody in the patient's serum to form complexes with the antigen and to fix complement (Fig. 14-12).

In complement fixation test, "sensitized" red cells are then added to the mixture. If the red cells are lysed, it indicates that there were no antibodies specific to the antigen in the serum of the patient. The complement therefore was not consumed in the test system and was available to be used by the anti-RBC antibodies, resulting in hemolysis. This reaction is considered negative. The test is considered positive if the red cells are not lysed. Nonlysis of the cells indicates that patient's serum had antibodies specific to the antigen, which have "fixed" complement. Hence, no complement was available to be activated by the indicator system.

### Key Points

The complement fixation reactions were used earlier for diagnosis of many infections, such as:

- Wassermann test for syphilis and
- Tests for demonstration of antibodies to *M. pneumoniae*, *Bordetella pertussis*, many different viruses, and to fungi (such as *Cryptococcus* spp., *Histoplasma*, and *Coccidioides immitis*).

Since this test is technically very cumbersome, and often difficult, it is no longer used now-a-days.

**Indirect complement fixation test:** Indirect complement fixation test is carried out to test the sera that cannot fix guinea pig complement. These include avian sera (e.g., parrot, duck) and mammalian sera (e.g., cat, horse). The test is carried out in duplicate and after the first test, the standard antiserum known to fix the complement is added to one set. Hemolysis indicates a positive test. In a positive test, if the serum contains antibody, the antigen would have been used up in the first test, standard antiserum added subsequently would fail to fix the complement, therefore causing hemolysis.

**Conglutinating complement adsorption test:** It is an alternative method for systems that do not fix guinea pig complement. Sheep erythrocytes sensitized with bovine serum are used as the indicator system. The bovine serum contains conglutinin, a  $\beta$  globulin that acts as antibody to the complement. Therefore, conglutinin causes agglutination of sensitized sheep erythrocytes if these are combined with complement, which is known as **conglutination**. If the horse complement had been used up by the antigen-antibody reaction in the first step, the agglutination of the sensitized cells does not occur.

### Immune adherence test

Immune adherence test is a test in which certain pathogens (e.g., *Vibrio cholerae*, *Treponema pallidum*, etc.) react with specific antibodies in the presence of complement and adhere to erythrocytes or platelets. The adherence of cells to bacteria is known as immune adherence, which facilitates phagocytosis of the bacteria.

### Immobilization test

Immobilization test is a complement-dependent test in which certain live bacteria, such as *T. pallidum*, are immobilized when mixed with patient's serum in the presence of complement. This forms the basis of *T. pallidum* immobilization test. A positive test shows serum to contain treponemal antibodies.

### Cytolytic or cytotoxic reactions

When a live bacterium, such as *V. cholerae*, is mixed with its specific antibody in the presence of complement, the bacterium is killed and lysed. This forms the basis of test used to measure anti-cholera antibodies in the serum.

### Neutralization Tests

Neutralization is an antigen-antibody reaction in which the biological effects of viruses and toxins are neutralized by homologous antibodies known as neutralizing antibodies. These tests are broadly of two types: (a) virus neutralization tests and (b) toxin neutralization tests.

### Virus neutralization tests

Neutralization of viruses by their specific antibodies are called virus neutralization tests. Inoculation of viruses in cell cultures, eggs, and animals results in the replication and growth of viruses. When virus-specific neutralizing antibodies are injected into these systems, replication and growth of viruses is inhibited. This forms the basis of virus neutralization test.

**Viral hemagglutination inhibition test** is an example of virus neutralization test frequently used in the diagnosis of viral infections, such as influenza, mumps, and measles. If patient's serum contains antibodies against certain viruses that have the property of agglutinating the red blood cells, these antibodies react with the viruses and inhibit the agglutination of the red blood cells.

### Toxin neutralization tests

Toxin neutralization tests are based on the principle that biological action of toxin is neutralized on reacting with specific neutralizing antibodies called antitoxins. Examples of neutralization tests include:

- *In vivo*—(a) Schick test to demonstrate immunity against diphtheria and (b) *Clostridium welchii* toxin neutralization test in guinea pig or mice.
- *In vitro*—(a) antistreptolysin O test and (b) Nagler reaction used for rapid detection of *C. welchii*.

### Opsonization

Opsonization is a process by which a particulate antigen becomes more susceptible to phagocytosis when it combines with **opsonin**. The opsonin is a heat-labile substance present in fresh normal sera. Unlike opsonin, **bacteriotropin** is heat-stable substance present in the serum but with similar activities.

The term “opsonic index” is defined as the ratio of the phagocytic activity of patient’s blood for a particular bacterium to the phagocytic activity of blood from a normal individual. It is used to study the progress of resistance during the course of disease. It is measured by incubating fresh citrated blood with the suspension of bacteria at 37°C for 15 minutes and estimating the average number of phagocytic bacteria from the stained blood films.

## Immunofluorescence

The property of certain dyes absorbing light rays at one particular wavelength (ultraviolet light) and emitting them at a different wavelength (visible light) is known as *fluorescence*. Fluorescent dyes, such as fluorescein isothiocyanate and lissamine rhodamine, can be tagged with antibody molecules. They emit blue-green and orange-red fluorescence, respectively under ultraviolet (UV) rays in the fluorescence microscope. This forms the basis of the immunological test. Immunofluorescence tests have wide applications in research and diagnostics. These tests are broadly of two types:

1. Direct immunofluorescence test
2. Indirect immunofluorescence test

### ► Direct immunofluorescence test

Direct immunofluorescence test is used to detect unknown antigen in a cell or tissue by employing a known labeled antibody that interacts directly with unknown antigen. If antigen is present, it reacts with labeled antibody and the antibody-coated antigen is observed under UV light of the fluorescence

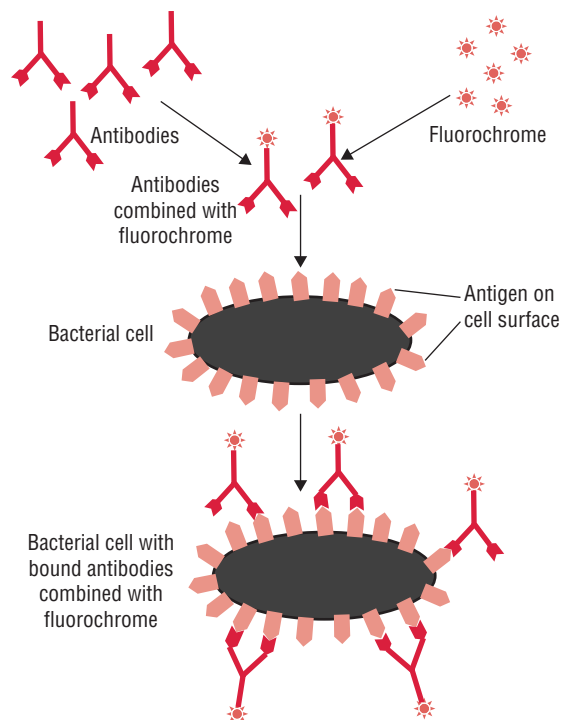

FIG. 14-13. Direct fluorescent antibody test.

microscope (Fig. 14-13). Direct immunofluorescence test is widely used for detection of bacteria, parasites, viruses, fungi, or other antigens in CSF, blood, stool, urine, tissues, and other specimens. Few examples include:

### Key Points

- Direct immunofluorescence test for antemortem diagnosis of rabies: The test is used for detection of rabies virus antigen in the skin smear collected from the nape of the neck in humans and in the saliva of dogs.
- Also used for detection of *N. gonorrhoeae*, *C. diphtheriae*, *T. pallidum*, etc. directly in appropriate clinical specimens.

The need for preparation of separate labeled antibody for each pathogen is the major disadvantage of the direct immunofluorescence test.

### ► Indirect immunofluorescence test

The indirect immunofluorescence test is used for detection of specific antibodies in the serum and other body fluids for serodiagnosis of many infectious diseases.

Indirect immunofluorescence is a two-stage process. In the first stage, a known antigen is fixed on a slide. Then the patient’s serum to be tested is applied to the slide, followed by careful washing. If the patient’s serum contains antibody against the antigen, it will combine with antigen on the slide. In the second stage, the combination of antibody with antigen can be detected by addition of a fluorescent dye-labeled antibody to human IgG, which is examined by a fluorescence microscope.

The first step in the indirect immunofluorescence test is the incubation of a fixed antigen (e.g., in a cell or tissue) with unlabeled antibody, which becomes associated with the antigen. Next, after careful washing, a fluorescent antibody (e.g., fluorescent labeled anti-IgG) is added to the smear. This second antibody will become associated to the first, and the antigen-antibody complex can be visualized on the fluorescence microscope.

The indirect method has the advantage of using a single labeled antiglobulin (antibody to IgG) as a “universal reagent” to detect many different specific antigen-antibody reactions. The test is often more sensitive than the direct immunofluorescence test.

### Key Points

Indirect immunofluorescence test is used widely to:

- Detect specific antibodies for serodiagnosis of syphilis, leptospirosis, amoebiasis, toxoplasmosis, and many other infectious diseases;
- Identify the class of a given antibody by using fluorescent antibodies specific for different immunoglobulin isotypes;
- Identify and enumerate lymphocyte subpopulations by employing monoclonal antibodies and cytofluorographs; and
- Detect autoantibodies, such as antinuclear antibodies in autoimmune diseases.

The major limitation of immunofluorescence is that the technique requires (a) expensive fluorescence microscope and reagents, (b) trained personnel, and (c) have a factor of subjectivity that may result in erroneous results.

## Enzyme Immunoassays

Enzyme immunoassays (EIAs) can be used for detection of either antigens or antibodies in serum and other body fluids of the patient. In EIA techniques, antigen or antibody labeled with enzymes are used. Alkaline phosphatase, horseradish peroxidase, and galactosidase are the enzymes used in the EIA tests.

The commonly used EIAs are enzyme-linked immunosorbent assays (ELISAs). The ELISA technique was first conceptualized and developed by Peter Perlmann and Eva Engvall at Stockholm University, Sweden.

These assays involve the use of an immunosorbent specific to either the antigen or antibody. Following the antigen-antibody reaction, chromogenic substrate specific to the enzyme (o-phenyldiamine dihydrochloride for peroxidase, p-nitrophenyl phosphate for alkaline phosphatase, etc.) is added. The reaction is detected by reading the optical density. Usually, a standard curve based on known concentrations of antigen or antibody is prepared from which the unknown quantities are calculated. There are different types of ELISAs available for the detection and quantitation of either the antigen or antibodies in serum and other body fluids. These include: (a) indirect ELISA, (b) sandwich ELISA, (c) competitive ELISA, and (d) ELISPOT assay.

### Indirect ELISA

The indirect ELISA is used for the quantitative estimation of antibodies in the serum and other body fluids. In this method, specimens are added to microtiter plate wells coated with antigen to which specific antibodies are to be detected. After a period of incubation, the wells are washed. If antibody was present in the sample, antigen-antibody complex would have

been formed and will not get washed away. On the other hand, if the specific antibody was not present in the specimen, there would not be any complex formation. Next, an anti-isotype antibody conjugated with an enzyme is added and incubated. After another washing step, a substrate for the enzyme is added. If there was complex formation in the initial step, the secondary anti-isotype antibody would have bound to the primary antibody, and there would be a chromogenic reaction between the enzyme and substrate. By measuring the optical density values of the wells, after a stop solution has been added to arrest the chromogenic reaction, one can determine the amount of antigen-antibody complex formed in the first step (Fig. 14-14).

### Key Points

The test is extensively used for determination of serum antibodies for diagnosis of human immunodeficiency virus (HIV) infection, Japanese encephalitis, dengue, and many other viral infections.

### Sandwich ELISA

The sandwich ELISA is used for the detection of antigen. In this test, the known antibody is coated and immobilized onto the wells of microtiter plates. The test sample containing the suspected antigen is added to the wells and is allowed to react with the antibodies in the wells. After the step of washing the well, a second enzyme-conjugated antibody specific for a different epitope of the antigen is added and allowed to incubate. After removing any free secondary antibody by rewashing, the specific substrate is added, and the ensuing chromogenic reaction is measured. The chromogenic reaction is then compared with a standard curve to determine the exact amount of the antigen present in the test sample. In a positive test, an enzyme acts on the substrate to produce a color, and its intensity can be measured by spectrophotometer or ELISA reader. The change of color can also be observed by the naked eye (Fig. 14-15).

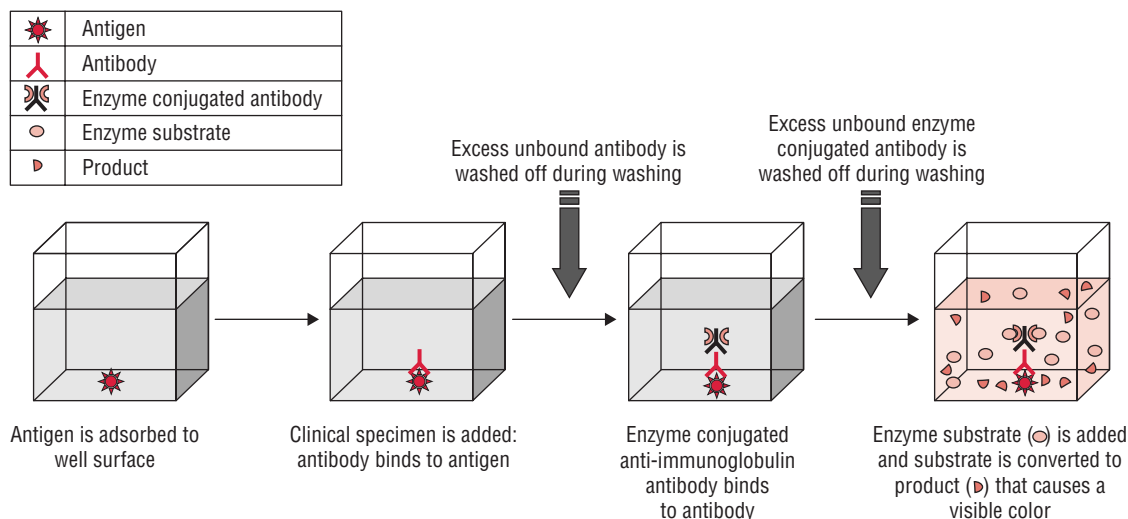

FIG. 14-14. Indirect ELISA test.



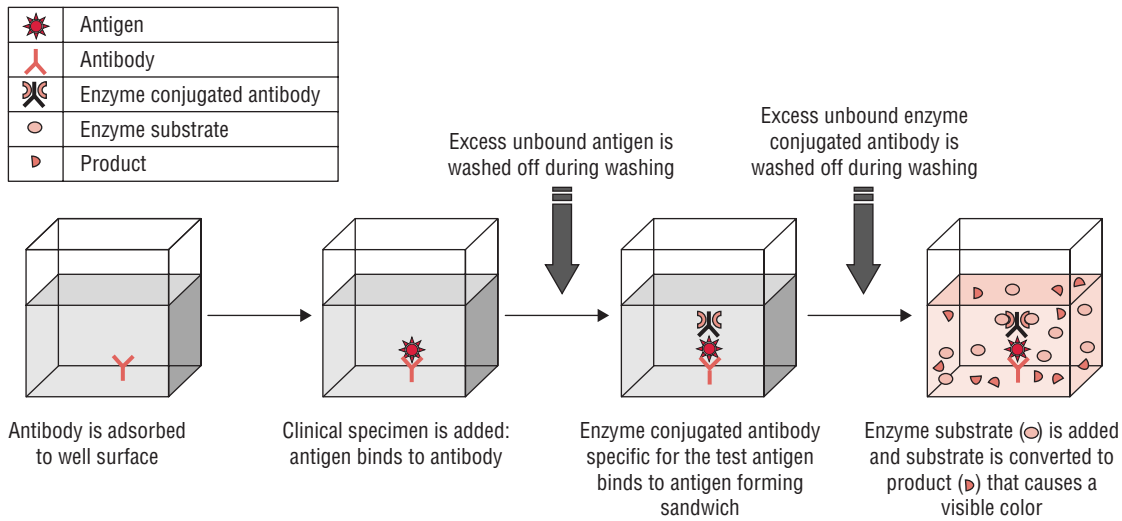

FIG. 14-15. Sandwich ELISA test.

### Key Points

The sandwich ELISA is used to detect rotavirus and enterotoxin of *Escherichia coli* in feces.

### ▶ Competitive ELISA

Competitive ELISA is another technique used for the estimation of antibodies present in a specimen, such as serum. Principle of the test is that two specific antibodies, one conjugated with enzyme and the other present in test serum (if serum is positive for antibodies), are used. Competition occurs between the two antibodies for the same antigen. Appearance of color indicates a negative test (absence of antibodies), while the absence of color indicates a positive test (presence of antibodies).

In this test, the microtiter wells are coated with HIV antigen. The sera to be tested are added to these wells and incubated at 37°C and then washed. If antibodies are present in the test serum, antigen-antibody reaction occurs. The antigen-antibody reaction is detected by adding enzyme-labeled-specific HIV antibodies. In a positive test, no antigen is left for these antibodies to act. Hence, the antibodies remain free and are washed away during the process of washing. When substrate is added, no enzyme is available to act on it. Therefore, positive result indicates no color reaction. In a negative test, in which no antibodies are present in the serum, antigen in the coated wells is available to combine with enzyme-conjugated antibodies and the enzyme acts on the substrate to produce color.

### Key Points

Competitive ELISA is the most commonly used test for detection of HIV antibodies in serum in patients with HIV.

### ▶ ELISPOT Assay

ELISPOT assay is a modification of ELISA. It allows the quantitative determination of number of cells in a population that are producing antibodies specific for a given antigen or an antigen for which one has a specific antibody. These tests have found application widely in the measurement of cytokines.

### Radioimmunoassay

When radioisotopes instead of enzymes are used as labels to be conjugated with antigens or antibodies, the technique of detection of the antigen-antibody complex is called as radioimmunoassay (RIA). RIA was first described in 1960 for measurement of endogenous plasma insulin by Solomon Berson and Rosalyn Yalow of the Veterans Administration Hospital in New York. Yalow was awarded the 1977 Nobel Prize for Medicine for the development of the RIA for peptide hormones, but because of his untimely death in 1972, Berson could not share the award.

The classical RIA methods are based on the principle of competitive binding. In this method, unlabeled antigen competes with radiolabeled antigen for binding to antibody with the appropriate specificity. Thus, when mixtures of radiolabeled and unlabeled antigen are incubated with the corresponding antibody, the amount of free (not bound to antibody) radiolabeled antigen is directly proportional to the quantity of unlabeled antigen in the mixture.

In the test, mixtures of known variable amounts of cold antigen and fixed amounts of labeled antigen and mixtures of samples with unknown concentrations of antigen with identical amounts of labeled antigen are prepared in the first step. Identical amounts of antibody are added to the mixtures. Antigen-antibody complexes are precipitated either by cross-linking with a second antibody or by means of the addition of reagents that promote the precipitation of antigen-antibody complexes. Counting radioactivity in the precipitates allows

the determination of the amount of radiolabeled antigen precipitated with the antibody. A standard curve is constructed by plotting the percentage of antibody-bound radiolabeled antigen against known concentrations of a standardized unlabeled antigen, and the concentrations of antigen in patient samples are extrapolated from that curve. The extremely high sensitivity of RIA is its major advantage:

## Key Points

### Uses of RIA:

- The test can be used to determine very small quantities (e.g., nanogram) of antigens and antibodies in the serum.
- The test is used for quantitation of hormones, drugs, HBsAg, and other viral antigens.

The main drawbacks of the RIA include: (a) the cost of equipment and reagents, (b) short shelf-life of radiolabeled compounds, and (c) the problems associated with the disposal of radioactive waste.

## Western Blotting

Western blotting is called so because the procedure is similar to Southern blotting, which was developed by Edwin Southern for the detection of DNA. While Southern blotting is done to detect DNA, Western blotting is done for the detection of proteins.

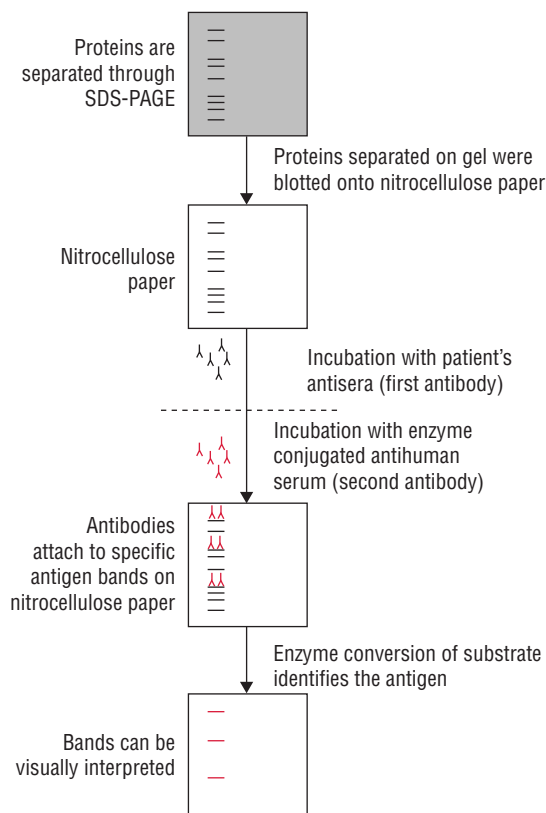

FIG. 14-16. Western blot test.

Western blotting is usually done on a tissue homogenate or extract. It uses SDS-PAGE (sodium dodecyl sulphate-polyacrylamide gel electrophoresis), a type of gel electrophoresis to first separate various proteins in a mixture on the basis of their shape and size. The protein bands thus obtained are transferred onto a nitrocellulose or nylon membrane where they are “probed” with antibodies specific to the protein to be detected. The antigen–antibody complexes that form on the band containing the protein recognized by the antibody can be visualized in a variety of ways. If the protein of interest was bound by a radioactive antibody, its position on the blot can be determined by exposing the membrane to a sheet of X-ray film, a procedure called **autoradiography**. However, the most generally used detection procedures employ enzyme-linked antibodies against the protein. After binding of the enzyme–antibody conjugate, addition of a chromogenic substrate that produces a highly colored and insoluble product causes the appearance of a colored band at the site of the target antigen. The site of the protein of interest can be determined with much higher sensitivity if a chemiluminescent compound along with suitable enhancing agents is used to produce light at the antigen site (Fig. 14-16).

## Key Points

Western blot technique has many uses as follows:

- It is used for identification of a specific protein in a complex mixture of proteins. In this method, known antigens of well-defined molecular weight are separated by SDS-PAGE and blotted onto nitrocellulose. The separated bands of known antigens are then probed with the sample suspected of containing antibody specific for one or more of these antigens. Reaction of an antibody with a band is detected by using either radiolabeled or enzyme-linked secondary antibody that is specific for the species of the antibodies in the test sample.
- It is also used for estimation of the size of the protein as well as the amount of protein present in the mixture.
- The Western blot test is most widely used as a confirmatory test for diagnosis of HIV, where this procedure is used to determine whether the patient has antibodies that react with one or more viral proteins or not.
- The Western blotting is also used for demonstration of specific antibodies in the serum for diagnosis of neurocysticercosis and tubercular meningitis.

## Chemiluminescence Assay

The chemiluminescence assay uses chemiluminescent compounds that emit energy in the form of light during the antigen–antibody reactions. The emitted lights are measured and the concentration of the analyte is calculated. The assay is a fully automated method, which is used commonly for drug sensitivity testing of *Mycobacterium tuberculosis*.

## **Immunoelectronmicroscopic Tests**

---

These are the types of antigen–antibody reactions that are visualized directly by electron microscope. These are of the following types:

### ▶ **Immunoelectronmicroscopy**

This is a test used to detect rotavirus and hepatitis A virus directly in feces. In this test, viral particles are mixed with specific antisera and are demonstrated as clumps of virion particles under the electron microscope.

### ▶ **Immunoenzyme test**

This test is used to detect antigen directly in tissue specimens, in which tissue sections are treated with peroxidase-labeled antisera to detect corresponding antigen. The peroxidase bound to the antigen is visualized under the electron microscope.

### ▶ **Immunoferritin test**

Electron-dense substances, such as ferritin are conjugated with antibody and such labeled antibodies reacting with antigen can be visualized under the electron microscope.

# Complement System

## Introduction

The term *complement* refers to the ability of a system of some nonspecific proteins in normal human serum to complement, i.e., augment the effects of other components of immune system, such as antibody. The complement system, which is an important component of the human innate host defense system, consists of approximately 20 proteins that are present in normal human serum.

## The Complement System

The complement system is an extremely powerful system comprising of rapidly acting glycoproteins, several proenzymes, and components, and it exists in an inactive state in the plasma. All normal individuals always have complement components in their blood.

## Properties of Complement

Complement shows the following properties:

1. It is present in sera of all mammals including humans and in lower animals including birds, amphibians, and fishes.
2. These are heat-labile substances that are inactivated by heating serum at 56°C for 30 minutes.
3. These are glycoproteins and are synthesized primarily by liver cells and to a very less extent by macrophages and many other cell types. The rate of synthesis of the various complement glycoproteins increase when complement is activated and consumed.
4. The complement usually does not bind to the antigen or antibody but only to antigen-antibody complex.
5. The importance of the complement lies in the fact that it contributes to both the acquired and innate immunity of an individual.

## Nomenclature of Complement

Complement components are designated by numerals, viz., C1–9. These components circulate in plasma in the form of proenzymes that are functionally inactive. Activation involves cleavage by proteolysis into peptide fragments. The fragments are designated with lowercase suffixes—for example, C3 is cleaved into two fragments, C3a and C3b. Normally, the large fragment

is designated “b”, and the small fragment “a”. But for historical reasons, with respect to the fragments of C2, the large fragment is designated C2a and the small one is designated C2b.

## Key Points

### *Effects of complement*

There are four main effects of complement:

- It causes lysis of cells (such as bacteria, viruses, allografts, and tumor cells).
- It generates mediators that participate in triggering specific cell functions, inflammation, and secretion of immunoregulatory molecules.
- It facilitates opsonization, the process by which bacteria are more readily and more efficiently engulfed by phagocytes.
- It causes immune clearance, in which immune complexes from the circulation are removed and are transported to spleen and liver.

## Activation of Complement

Complement activation takes place through any of the following three pathways:

1. The classical pathway
2. The alternative pathway
3. The lectin pathway

Of these, alternative and lectin pathways are important in the innate immunity of the host. These two are also more important when the human host is infected by a microorganism for the first time, because the antibody required to trigger the classical pathway is not present.

All the three activation pathways lead to activation of C3, resulting in the production of C3b. Hence, C3b is considered as the central molecule in the activation of the complement cascade.

## Key Points

The C3b has two important functions to perform:

- First, it combines with other components of the complement to produce C5 convertase, the enzyme that leads to the production of membrane attack complex; and
- Second, it opsonizes bacteria due to the presence of receptors for C3b on the surface of the phagocytes.

The final steps that lead to the formation of a membrane attack complex are same in all the pathways. When these complement components are activated, a sequential, rapid cascading pattern ensues. This is because once a complement component is activated, it is either cleaved or becomes bound to a previously activated component or complex of complement components. Also, each component or complex of components, once activated, generally amplifies the cascading process by activating many molecules of the next component in the series.

## Classical Pathway of Complement Activation

The classical pathway is a chain of events in which complement components react in specific sequences as a cascade resulting in cell lysis. It is activated by antibody bound to antigen but never by native or free antibody.

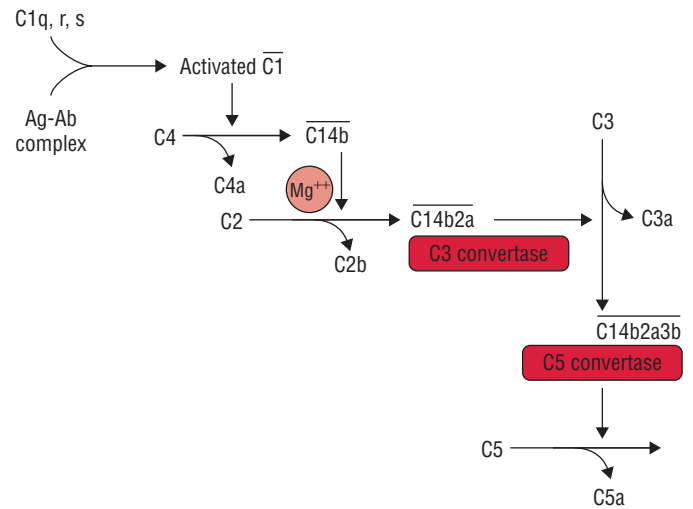

FIG. 15-1. Classical pathway of activation of the complement.

### Key Points

**Activators of the classical pathway:** Activators of classical pathways include the following:

- Immunoglobulins IgM and IgG. The IgG subclasses vary with regard to their efficiency in activating the complement; IgG3 immunoglobulins are the most efficient, followed by IgG1 and IgG2. IgG4 immunoglobulins do not activate the classical pathway.
- Native, free IgG or IgM do not activate the complement system. A single, native IgG molecule will not bind and activate the complement pathway. However, if antibodies of the IgG class are aggregated by antigen binding, this will result in complement fixation and activation. The formation of an antigen-antibody complex induces conformational changes in the Fc portion of the IgM molecule that expose a binding site for the C1 component of the complement system
- Staphylococcal protein A,
- C-reactive protein, and
- DNA

**Steps of activation of classical pathway:** The classical pathway of complement activation usually begins with the formation of soluble antigen-antibody complexes (immune complexes) or with the binding of antibody to antigen on a suitable target, such as a bacterial cell (Fig. 15-1). Following are the sequential steps in the activation of classical pathway:

1. Activation of C1 is the first step in the cascade of classical pathway activation. The C1 actually is a complex of three different types of molecules: C1q, C1r, and C1s. C1q first combines with the Fc portion of the bound antibody, IgM or IgG. This results in the sequential activation of C4, C2, and C3. For C1 to be activated, it must bind to at least two adjacent Fc regions. This means that the concentration of antibody of the IgG class must be relatively high and that the specific antigenic determinants recognized by the IgG antibody must be in close proximity. When pentameric IgM is bound to antigen on a target surface, it assumes the

so-called stable configuration, in which at least three binding sites for the C1q are exposed. Since IgG molecules have a lower valency, about 1000 of them are needed to ensure the initiation of the complement pathway as against only one IgM molecule.

2. C1q binding in the presence of calcium ions leads to activation of C1r and C1s. Activated C1s is an esterase that splits C4 into two fragments: a small soluble fragment (C4a) and a larger fragment (C4b). C4a has anaphylatoxin activity, and C4b binds to cell membrane along with C1. C4b in the presence of  $Mg^{2+}$  splits C2 into C2a and C2b. The smaller fragment (C2b) diffuses away, while the larger fragment (C2a) remains attached to C4b. The resulting C4b2a complex possesses enzymatic activity and is called **C3 convertase**, which converts C3 into an active form.
3. The C3 convertase activate thousands of C3 molecules and splits these molecules into C3a and C3b. A single C3 convertase molecule can generate over 200 molecules of C3b, resulting in tremendous amplification at this step of the sequence. The biological importance of activated C3b as well as C4b is that they are able to bind to C3b/C4b receptors (currently designated as *CR1 receptors*) present on almost all host cells, most notably phagocytes.

The increased affinity of phagocytic cells for C3b (or iC3b)/C4b-coated particles is known as **immune adherence**. The latter is responsible for a significant enhancement of phagocytosis, which is one of the main defense mechanisms of the body.

4. Some of the C3b binds to C4b2a to form a trimolecular complex C4b2a3b called **C5 convertase**. The C5 convertase splits C5 into C5a and C5b. C5a diffuses away, while C5b attaches to C6 and initiates formation of C5b-9 complex otherwise known as **membrane attack complex (MAC)**.

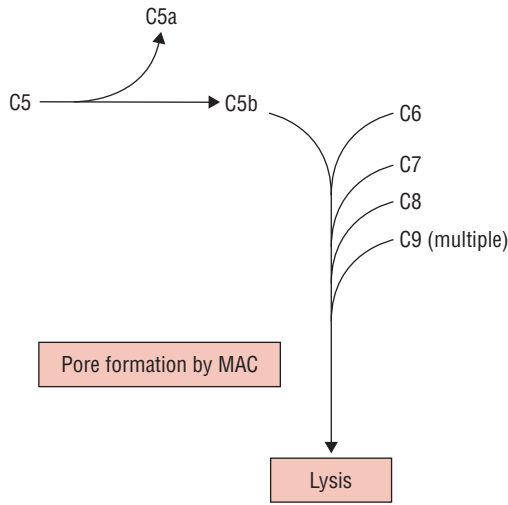

FIG. 15-2. Formation of membrane attack complex.

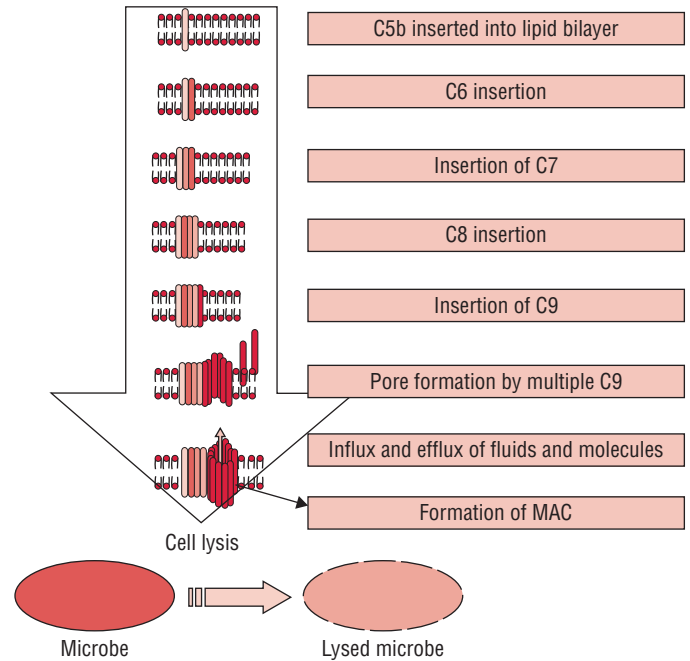

FIG. 15-3. Action of membrane attack complex.

## Key Points

### Membrane attack complex

The formation of the MAC (Fig. 15-2) is the terminal sequence of all three different pathways including the classical pathway. All the three pathways converge at the step involving the formation of the MAC. The formation of the MAC involves the participation of the complement components C5b, C6, C7, C8, and C9. A complex of C5b, C6, and C7 is first formed in the soluble phase and then attaches to the cell membrane through the hydrophobic amino acid groups of C7. The C7 becomes exposed as a consequence of the binding of C7 to the C5b–C6 complex.

Released C5b67 complexes can insert into the membrane of nearby cells and mediate “innocent-bystander” lysis. Regulator proteins in human sera normally prevent this from occurring, but in certain diseases cell and tissue damage may occur due to this process of innocent-bystander lysis.

The membrane-bound C5b–6–7 complex acts as a receptor for C8 and C9. C8, on binding to the complex, stabilizes the attachment of the complex to the foreign cell membrane. The C5b–8 complex acts as a catalyst for C9, which is a single chain glycoprotein with a tendency to polymerize spontaneously.

- The C5b–8 complex on binding to C9 molecules undergoes polymerization, which finally ends in the formation of C5b–9 complex also known as MAC. The MAC forms a transmembrane channel of 100 Å diameter in the cell. This transmembrane channel allows the free exchange of ions between the cell and the surrounding medium. Due to the rapid influx of ions into the cell and their association with cytoplasmic proteins, the osmotic pressure rapidly increases inside the cell. This results in an influx of water, swelling of the cell, and, for certain cell types, rupture of the cell membrane and finally lysis (Fig. 15-3).

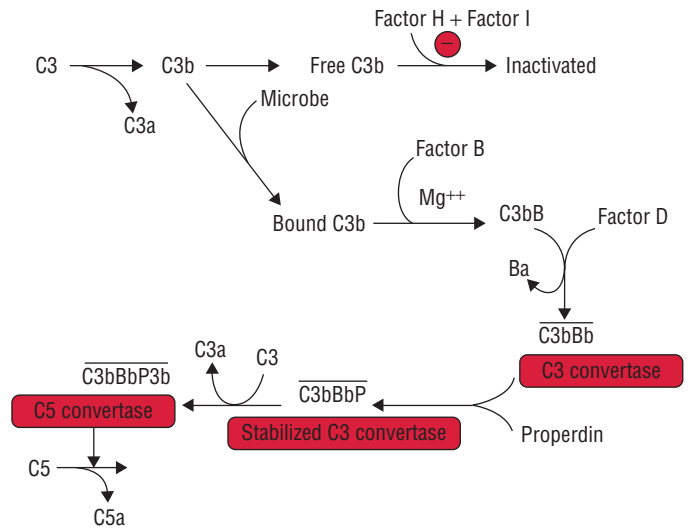

FIG. 15-4. Alternative pathway of activation of the complement.

## Alternative Pathway of Complement Activation

The alternative pathway was first described by Pillemer in 1954. It differs from the classical pathway in (a) the nature of activating substances and (b) the sequence of events itself. The alternative pathway is unique in not requiring antigen–antibody complexes to activate the complement. This pathway does not depend on antibody and does not involve the early complement components (C1, C2, and C4) for activation of the complement. It, therefore, can be activated before the establishment of an immune response to the infecting pathogen (Fig. 15-4).

## Key Points

**Activators of the alternative pathway:** Activators of the alternative pathway of complement activation include (a) IgA, (b) IgD, (c) bacterial endotoxin, (d) cobra venom factor, and (e) nephritic factor.

**Steps of activation of alternative pathway:** The initial component of the alternative pathway involves four serum proteins: C3b, factor B, factor D, and properdin.

1. The C3b binds with factor B to form C3bB complex. The interaction between C3b and factor B is stabilized by  $Mg^{2+}$ , which is the only ion required for functional activation of the alternative pathway. Therefore, tests to discriminate between the two complement activation pathways are often based on the selective chelation of  $Ca^{2+}$  (to disrupt C1q, C1r<sub>2</sub>, and C1s<sub>2</sub>) and the addition of sufficient  $Mg^{2+}$  to allow activation of the alternative pathway.
2. The C3bB is split into two fragments, Ba and Bb, by another serum protein called factor D or C3 proactivase. Since factor D has never been isolated in its proenzyme form, it is generally believed to be activated immediately upon leaving the hepatocyte where it is synthesized. The Ba is released into the medium and the Bb binds to C3b forming the C3bBb complex, which possesses the C3 convertase activity.
3. The C3bBb complex activates more C3, leading to the formation of more C3bBb, which in turn is capable of activating C5 and the MAC. The C3bBb complex has a half-life of only 5 minutes, but by binding with properdin it forms PC3bBb complex, which is relatively heat stable.
4. The alternative pathway then proceeds from C3 to produce finally the MAC, in the same way as occurs in the classical pathway.

## Lectin Pathway of Complement Activation

The lectin pathway, as the name suggests, is triggered by lectins. Lectins are the proteins that recognize and bind to specific carbohydrate targets. The mannose-binding lectin (MBL) is one such protein that takes part in the lectin pathway of

complement activation. MBL is a large serum protein that binds to nonreduced mannose, fructose, and glucosamine on bacterial and other cell surfaces with mannose-containing polysaccharides (*mannans*) (Fig. 15-5).

The binding of MBL to a pathogen results in the secretion of two MBL-associated serine proteases: MASP-1 and MASP-2. MASP-1 and MASP-2 are similar to C1r and C1s, respectively, and MBL is similar to C1q. Formation of the MBL/MASP-1/MASP-2 trimolecular complex results in activation of MASPs and subsequent cleavage of C4 into C4a and C4b. Subsequently, it proceeds to produce MAC in the same way as that occurs in the classical and alternative pathways. Differences between classical, alternative, and lectin pathways are summarized in Table 15-1.

## Regulation of Complement System

Since the complement system involves the formation of many biologically active substances, there are many regulatory systems to prevent unwarranted damage to the human host. The activities of the different complement components activated at each stage of the cascade are regulated by several

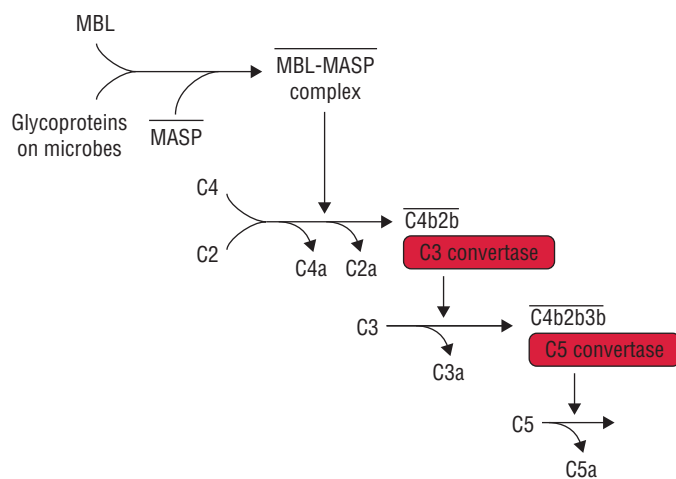

FIG. 15-5. Lectin pathway of activation of the complement.

TABLE 15-1

Comparison of classical, alternative, and lectin pathways

Classical pathway	Alternative pathway	Lectin pathway
Chain of events in which components react in specific sequence following activation of C1	Activation of C3 without prior participation of C1,4,2	Activated by binding of mannose-binding lectin to mannose residues on surface of microorganisms
Requires binding of C1 to antigen-antibody complex	Activators are bacterial endotoxins, IgA and IgD, cobra venom factor, and nephritic factor	No role for antibodies; similar to alternate pathway
Cannot be considered as a component of innate immune mechanism	It is a component of the innate immune mechanism	Can be considered as a component of innate immune mechanism

mechanisms. The following are regulators of the complement system:

**1. Level of antibody:** The level of antibody itself is the first regulatory step in the classical pathway. If antigen is not bound to the antibodies, the complement-binding sites on the heavy chains of IgG and IgM are unavailable to the C1 component of the complement. This means that complement is not activated even if IgM and IgG are present in the blood at all times. However, when antigen binds with specific antibodies, a conformational shift occurs and that allows the C1 component to bind and initiate the cascade reaction.

**2. C1 inhibitors:** These inhibitors play a critical role in limiting unnecessary complement activation. These prevent the formation and function of C1qrs complex by causing C1s to dissociate from C1qrs. The C1 inhibitors may also aid in the removal of the entire C1 complex from the antigen-antibody complexes.

**3. Other inhibitory substances:** Multiple substances have inhibitory effects over different steps of the activation sequence of the classical pathway. These are considered to be host cell protective mechanisms. These mechanisms probably help to protect the host cells from the possible bystander damage initiated by activated complement fragments (C3b and C4b) being formed on and near its surface.

**4. Decay-accelerating factor (DAF):** It is another inhibitory substance located in a large variety of host cell membranes. It is so termed because it can accelerate the dissociation of active C4b2a complexes, turning off their ability to activate native C3. In addition, DAF remains attached to membrane-bound C4b and C3b, and prevents the subsequent interaction with C2a and factor B, respectively. As a consequence, the two types of C3 convertases, C4b2a and C3bBb, are not formed; hence, the rate of C3 breakdown is reduced and the host cells are spared from complement-mediated membrane damage.

**5. Regulation of alternative pathway:** The alternative pathway has its own set of regulatory proteins and mechanisms. It is mediated by the binding of factor H to C3b and cleavage of this complex by specific plasma inhibitor factor I, a protease. This reduces the amount of C5 convertase available.

## Biological Effects of Complement

The main role of complement is to amplify the humoral immune response. The complement through its various products participates in the inflammatory response, opsonization of antigen, viral neutralization, and clearance of immune complexes as follows:

### Chemotaxis

- C5a is a chemotactic molecule specifically recognized by polymorphonuclear leukocytes or phagocytic cells. This substance causes leukocytes to migrate to a tissue in

which an antigen-antibody reaction is taking place. At that site, a phagocytic cell recognizes opsonized particles and ingests them.

- C5a not only has a chemotactic effect on neutrophils, but also activates these cells causing their reversible aggregation and release of stored enzymes, including proteases.
- C5a also enhances the adhesiveness of neutrophils to the endothelium.

### Opsonization

Complement plays an important role in opsonization of pathogenic bacteria and viruses. Bacteria and viruses are easily phagocytosed by phagocytic cells in the presence of complement component C3b. This is because the receptors for the C3b component are present on the surface of many phagocytes.

### Hypersensitivity Reactions

Complement participates in type II (cytotoxic) and type III (immune-complex) hypersensitivity reactions. The C3a, C4a, and C5a components stimulate degranulation of mast cells with release of mediators, such as histamine. The C3a fragments bind to receptors on basophils and mast cells and induce the release of stored vasoactive amines (e.g., histamine) and heparin. The release of histamine into the tissues results in increased capillary permeability and smooth muscle contraction. Fluid is released into the tissue, thereby causing edema and swelling.

There is some evidence that C3a and C5a may also act directly on endothelial cells, causing increased vascular permeability. The end result is very similar to the classical anaphylactic reaction that takes place when IgE antibodies bound to the membranes of mast cells and basophils react with the corresponding antigens. For this reason, C3a and C5a are called as *anaphylatoxins*.

### Cytolysis

Complement mediates cytolysis. Insertion of C5b-9 complex (MAC) into the cell membrane leads to killing or lysis of erythrocytes, bacteria, and tumor cells. The insertion of the MAC complex results in disruption of the membrane, thereby leading to entry of water and electrolytes into the cell.

### Enhancement of Antibody Production

The binding of C3b to the surface receptors on the activated B cells markedly enhances the production of antibodies in comparison to that of B cells activated by antigen alone. Hence, deficiency of C3b leads to reduced production of antibodies. Therefore, low concentration of both C3b and antibodies affects host defense, resulting in severe pyogenic infections.



**TABLE 15-2** Diseases associated with complement deficiencies

Deficiency	Disorder	Salient features
C1 esterase inhibitor	Hereditary angioedema	Transient but recurrent localized edema in the skin, gastrointestinal tract, and respiratory tract
C1q	Associated with hypogammaglobulinemia and severe combined immunodeficiency disease	Repeated infections
C2 and C4	Similar to SLE	Due to failure in clearance immune-mediated complexes
C3	Severe recurrent pyogenic infections	<i>Streptococcus pneumoniae</i> infections
C5	Impaired chemotaxis	Increased susceptibility to bacterial infection
C5–C8	Bacteremia	Gram-negative diplococci and toxoplasmosis

### Deficiency of Complement

Complement plays an important role in the well-being of humans. Deficiency of various components may result in many diseases as follows:

1. Inherited deficiency of C1 esterase inhibitors causes angioedema. The low level of C1 esterase inhibitors leads to overproduction of esterase. This leads to an increase in release of anaphylatoxins, which cause capillary permeability and edema.
2. Acquired deficiency of DAF results in an increase in complement-mediated hemolysis. The condition manifests clinically as paroxysmal nocturnal hemoglobinuria.
3. Inherited or acquired deficiency of C5–8 components greatly enhances susceptibility to *Neisseria* bacteremia and other infections. Deficiency of C3 leads to severe recurrent pyogenic sinusitis and respiratory infections.
4. The synthesis of sufficient quantities of complement is reduced in the patients with severe liver disease, such as chronic hepatitis or alcoholic cirrhosis. These patients, therefore, are highly susceptible to infections caused by pyogenic bacteria.

Deficiency of complement components and diseases associated with these complement deficiency are summarized in Table 15-2.

### Biosynthesis of Complement

Various components of the complement are synthesized at various sites of the body. For example, C1 is synthesized in the intestinal epithelium, both C2 and C4 in the macrophages, C5 and C8 in the spleen, and C3, C6, and C9 in the liver. There is an increase in the level of C3, C4, C5, and C6 in the acute phase of inflammation. Complement along with some other plasma proteins known as *acute phase reactants* show a rise in acute inflammation.

### Quantitation of Complement

Estimation of the highest dilutions of serum lysing sheep erythrocytes sensitized by antierythrocytic antibody complement activity of the serum is a method frequently used to measure complement activities of the serum. Radial immunodiffusion in agar is employed to measure complement components in the serum.

# Structure and Function of Immune System

## Introduction

The lymphoreticular system is a complex organization of cells of diverse morphology, distributed widely in different organs and tissues of the human body, and is responsible for immunity. It consists of lymphoid and reticuloendothelial components and is responsible for immune response of the host. The lymphoid cells, which include lymphocytes and plasma cells, are responsible for conferring specific immunity. On the other hand, the reticuloendothelial system, which consists of phagocytic cells and plasma cells, is responsible for nonspecific immunity. These cells kill microbial pathogens and other foreign agents, and remove them from blood and tissues.

## Lymphoid Tissues and Organs

The specific immune response to antigen is of two types: (a) humoral or antibody-mediated immunity, mediated by antibodies produced by plasma cells; and (b) cell-mediated immunity, mediated by sensitized lymphocytes. The immune system is organized into several special tissues, which are collectively termed **lymphoid** or **immune tissues**. The tissues that have evolved to a high degree of specificity of function are termed **lymphoid organs**.

Lymphoid organs include the gut-associated lymphoid tissues—tonsils, Peyer's patches, and appendix—as well as aggregates of lymphoid tissue in the submucosal spaces of the respiratory and genitourinary tracts. The lymphoid organs, based on their function, are classified into central (primary) and peripheral (secondary) lymphoid organs.

## Central (Primary) Lymphoid Organs

Central or primary lymphoid organs are the major sites for lymphopoiesis. These organs have the ability to produce progenitor cells of the lymphocytic lineage. These are the organs in which precursor lymphocytes proliferate, develop, and differentiate from lymphoid stem cells to become immunologically competent cells. The primary lymphoid organs include thymus and bone marrow. In mammals, T cells mature in thymus and B cells in fetal liver and bone marrow. After acquiring immunological competency, the lymphocytes migrate to secondary lymphoid organs to induce appropriate immune response on exposure to antigens.

## Thymus

Thymus is the first lymphoid organ to develop. It reaches its maximal size at puberty and then atrophies, with a significant decrease in both cortical and medullary cells and an increase in the total fat content of the organ. The thymus is a flat, bilobed organ situated above the heart. Each lobe is surrounded by a capsule and is divided into lobules, which are separated from each other by strands of connective tissue called trabeculae. Each lobule is organized into two compartments: cortex and medulla. The stroma of the organ is composed of dendritic cells, epithelial cells, and macrophages (Fig. 16-1, Color Photo 9).

- **Cortex:** It consists mainly of (a) cortical thymocytes, the immunologically immature T lymphocytes, and (b) a small number of macrophages and plasma cells. In addition, the cortex contains two subpopulations of epithelial cells, the epithelial nurse cells and the cortical epithelial cells, which form a network within the cortex.
- **Medulla:** It contains predominantly mature T lymphocytes and has a larger epithelial cell-to-lymphocyte ratio than the cortex. The concentric rings of squamous epithelial cells known as Hassall's corpuscles are found exclusively in the medulla.

Thymus is the site where a large diversity of T cells is produced and so they can recognize and act against a myriad number of antigen-MHCs (major histocompatibility complexes). The thymus induces the death of those T cells that cannot recognize antigen-MHCs. It also induces death of those T cells that react with self-antigen MHC and pose a danger of causing autoimmune disease. More than 95% of all thymocytes die by apoptosis in the thymus without ever reaching maturity.

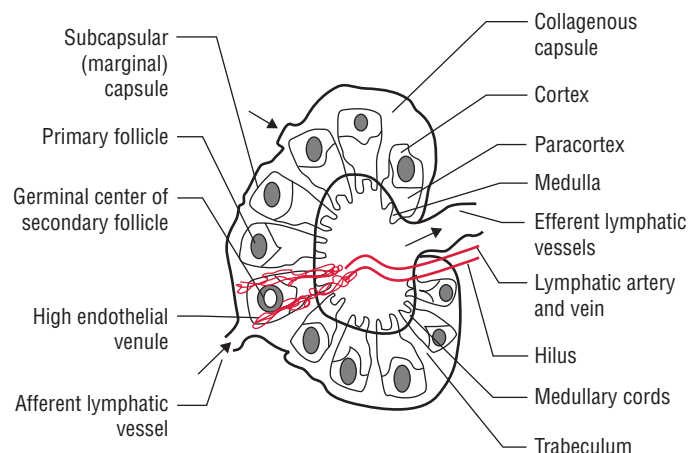

FIG. 16-1. A schematic diagram of the thymus.

## Key Points

**Functions of the thymus:** The thymus is the only clearly individualized primary lymphoid organ in mammals. It has many functions:

- Production of thymic lymphocytes is the primary function of the thymus. It is a major organ for proliferation of lymphocytes in the body.
- It is believed to play a key role in determining the differentiation of T lymphocytes. The lymphocytes during maturation acquire new surface antigens (*Thy antigens*) and are called as T lymphocytes or T cells (thymus dependent). The thymus confers immunological competence on these cells during their stay in the organ. Lymphocyte proliferation in thymus, unlike in the peripheral lymphoid organs, is not dependent on antigenic stimulus.
- The T lymphocytes are primarily responsible for cell-mediated immunity (CMI). The absence of thymus in neonatally thymectomized mice is associated with gross deficiency of CMI, resulting in lymphopenia, deficient graft rejection, and runting disease. Congenital aplasia of thymus in man in Di-George syndrome is another example of deficiency of CMI due to absence of thymus.

## ► Bone marrow

Some lymphoid cells develop and mature within the bone marrow and are referred to as **B cells** (B for *bursa of Fabricius*, or bone marrow). The function of bursa of Fabricius in birds is played by bone marrow in humans. Bone marrow is the site for proliferation of stem cells and for the origin of pre-B cells and their maturation to become immunoglobulin-producing lymphocytes.

Immature B cells proliferate and differentiate within the bone marrow. Stromal cells within the bone marrow interact directly with the B cells and secrete various cytokines that are required for the development of B cells. Like thymic selection during T-cell maturation, a selection process within the bone marrow eliminates B cells with self-reactive antibody receptors.

B lymphocytes develop their B-cell receptors (BCRs) by DNA rearrangement. They express auxiliary molecules, such as Ig $\alpha$  and Ig $\beta$ , and begin to express IgM on their surfaces before leaving the bone marrow. Subsequently, mature B lymphocytes also acquire C3 and Fc receptors on their surfaces. B lymphocytes on their surfaces either bear IgM alone or in association with IgG or IgA depending upon the production of particular class of immunoglobulin. The B lymphocytes are transformed into plasma cells and secrete antibodies. B lymphocytes are primarily responsible for antibody-mediated immunity.

## Peripheral (Secondary) Lymphoid Organs

Peripheral or secondary lymphoid organs consist of (a) lymph nodes, (b) spleen, and (c) nonencapsulated structures, such as mucosa-associated lymphoid tissues (MALT). These organs serve as the sites for interaction of mature lymphocytes with antigens.

## ► Lymph nodes

The lymph nodes are extremely numerous and disseminated all over the body. They play a very important and dynamic role in

the initial or inductive states of the immune response. Lymph nodes measure 1–25 mm in diameter and are surrounded by a connective tissue capsule. The lymph node has two main parts: cortex and medulla. The reticulum or framework of the lymph node is composed of phagocytes and specialized types of reticular or dendritic cells (Color Photo 10).

**Cortex:** The cortex and the deep cortex, also known as paracortical area, are densely populated by lymphocytes. Roughly spherical areas containing densely packed lymphocytes, termed primary lymphoid follicles or nodules, are found in the cortex. B and T lymphocytes are found in different areas in the cortex.

The primary lymphoid follicles predominately contain B lymphocytes. They also contain macrophages, dendritic cells, and some T lymphocytes. The primary follicles are very densely packed with small lymphocytes, not actively involved in an immune response. The larger, less dense follicles, termed secondary follicles, are found in the cortex of a lymph node draining an area in which an infection has taken place. The secondary follicles contain clear germinal centers where B lymphocytes actively divide as a result of antigenic stimulation.

T lymphocytes are found predominantly in the deep cortex or paracortical area; for this reason, the paracortical area is designated as T-dependent. Interdigitating cells are also present in this area, where they present antigen to T lymphocytes.

**Medulla:** It is less densely populated and is composed mainly of medullary cords. These cords are elongated branching bands of the lymphocytes, plasma cells, and macrophages. They drain into the hilar efferent lymphatic vessels. Plasma cells are also found in the medullary cords.

Following the period of division, there is a rigorous selection process in which more than 90% of these B cells die by apoptosis or cell death. As antigen is carried into a regional node by the lymph, it is trapped, processed, and presented together with class II MHC molecules by interdigitating dendritic cells in the paracortex, resulting in the activation of  $T_H$  cells. The initial activation of B cells is also thought to take place within the T-cell-rich paracortex. Once activated,  $T_H$  and B cells form small foci consisting largely of proliferating B cells at the edges of the paracortex. Some B cells within the foci differentiate into plasma cells secreting IgM and IgG.

## Key Points

**Functions of the lymph nodes:** Lymph nodes serve the following functions:

- They act as filter for the lymph, the fluid, and cellular content of the lymphocytic circulatory system.
- They also provide sites for mingling of lymphocytes, monocytes, and dendritic cells for initiation of immune responses. Most antigen-activated B cells divide and differentiate into antibody-producing plasma cells in lymphoid follicles, but only a few B cells in the antigen-activated population find their way into germinal centers. Those that do, undergo one or more rounds of cell division during which the genes that encode their antibodies mutate at an unusually high rate.
- They phagocytose microbial pathogens and other foreign substances.

## ► Spleen

The spleen is the largest lymphoid organ. It is a large, ovoid secondary lymphoid organ situated high in the left abdominal cavity. The spleen parenchyma is heterogeneous and is composed of the white and the red pulp. It is surrounded by a capsule made up of connective tissue (Color Photo 11). The spleen unlike the lymph nodes is not supplied by lymphatic vessels. Instead, blood-borne antigens and lymphocytes are carried into the spleen through the splenic artery. The narrow central arterioles, which are derived from the splenic artery after multiple branchings, are surrounded by lymphoid tissue (periarteriolar lymphatic sheath). In the white pulp, T lymphocytes are found in the lymphatic sheath immediately surrounding the arteriole. B lymphocytes are primarily found in perifollicular area, germinal center, and mantle layer, which lie more peripherally relative to the arterioles.

### Key Points

**Functions of the spleen:** The spleen plays a major role in:

- Mounting immune responses to antigens in the blood stream. The circulating antigens are trapped by the macrophages present in the marginal zone. These macrophages then process the antigen, migrate deeper into the white pulp, and initiate the immune response by interacting with T and B lymphocytes.
- Filtering or clearing of (a) infectious organisms; (b) aged or defectively formed elements (e.g., spherocytes, ovalocytes); and (c) particulate matter from the peripheral blood. In addition, the spleen traps blood-borne antigens and microbes. The main filtering function is performed by the macrophages lining up the splenic cords.

The effect of splenectomy on the immune response depends on the age at which the spleen is removed:

- In children, splenectomy often leads to an increased incidence of bacterial sepsis caused primarily by *Streptococcus pneumoniae*, *Neisseria meningitidis*, and *Haemophilus influenzae*.
- In adults, the adverse effects are less; although in some, it makes the host more susceptible to blood-borne bacterial infections.

## ► Mucosa-associated lymphoid tissues

Mucosa-associated lymphoid tissues (MALT) consist of the lymphoid tissues of the intestinal tract, genitourinary tract, tracheobronchial tree, and mammary glands. All of the MALT are noncapsulated and contain both T and B lymphocytes, and the latter predominate. Structurally, these tissues include clusters of lymphoid cells in the lamina propria of intestinal villi, tonsils, appendix, and Peyer's patches.

**Tonsils:** These are present in the oropharynx and are predominantly populated by B lymphocytes. These are the sites of intense antigenic stimulation, as shown by the presence of numerous secondary follicles with germinal centers in the tonsillar crypts.

**Peyer's patches:** These are lymphoid structures that are found within the submucosal layer of the intestinal lining.

The follicles of the Peyer's patches are extremely rich in B cells, which differentiate into IgA-producing plasma cells. Specialized epithelial cells, known as M cells, are found in abundance in the dome epithelia of Peyer's patches, particularly at the ileum. These cells take up small particles, virus, bacteria, etc., and deliver them to submucosal macrophages, where the engulfed material is processed and presented to T and B lymphocytes.

### Key Points

**MALTs** play an important role in defense system of the human host. This is demonstrated by large population of antibody-producing plasma cells in MALT, whose number far exceeds that of plasma cells in the spleen, lymph nodes, and bone marrow, when combined together. In addition to spleen and lymph nodes, MALTs facilitate interaction among circulating leukocytes.

## Lymphatic Circulatory System

Leukocytes and their products use two circulatory systems: cardiovascular system and the lymphatic circulatory system. The cardiovascular system is responsible for circulation of blood throughout the body. Peripheral blood is "filtered" by the spleen and liver. Organisms and antigens that enter directly into the systemic circulation are trapped in these two organs, of which the spleen plays the most important role as a lymphoid organ. The **lymphatic circulatory system**, on the other hand, is an extensive capillary network that collects lymph, a clear watery fluid containing leukocytes and cellular debris, from various organs and tissues.

Cleared lymph originating from below the diaphragm and the upper left half of the body drains via efferent lymphatics into the thoracic duct for subsequent drainage into the left innominate vein. Cleared lymph originating from the right side above the diaphragm drains into the right lymphatic duct, which subsequently drains into the origin of the right innominate vein. The same routes are followed by the lymphocytes stimulated and produced in the lymph nodes, or peripheral lymphoid tissues, which eventually reach the systemic circulation.

## Cells of the Lymphoreticular System

It is essential for the immune system to distinguish its own molecules, cells, and organs (self) from those of foreign origin (nonself). The innate immunity does this by expressing germline-encoded pattern recognition receptors on the surface of its cells, receptors that recognize structures on potentially invasive microorganisms. The adaptive immunity, on the other hand, makes use of somatically generated epitope-specific T-cell receptors (TCRs) and B-cell receptors (BCRs). These receptors are produced randomly and fresh within each individual T and B lymphocytes by gene

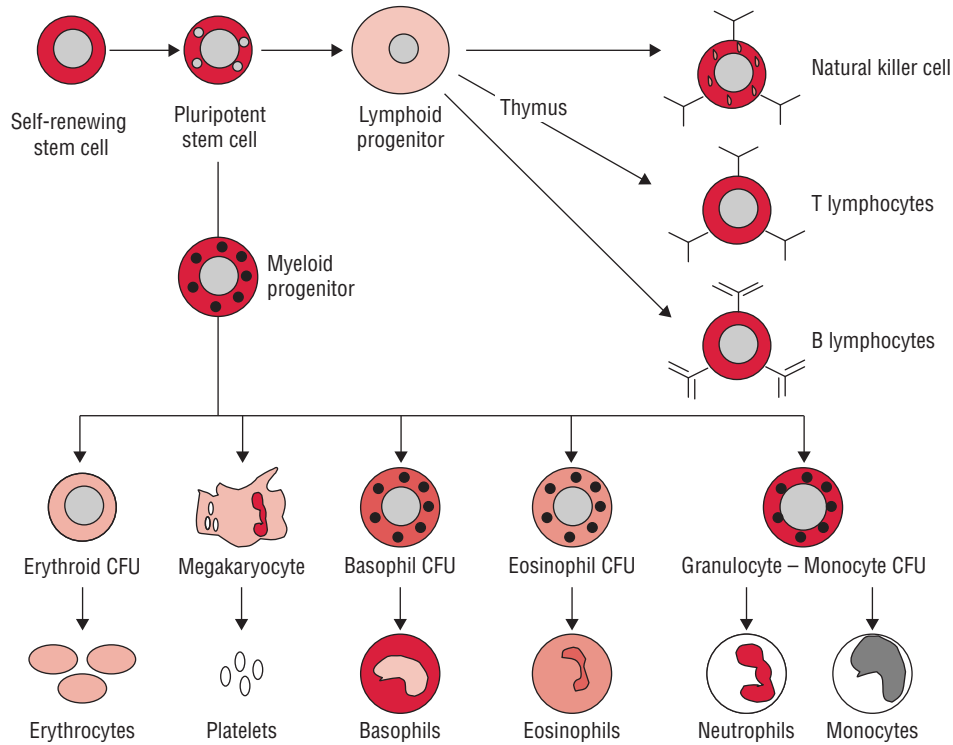

FIG. 16-2. Proliferation and development of cells of lymphoreticular system.

recombination prior to encounter with antigens (Fig. 16-2). The cells involved in the adaptive immune responses are (a) lymphocytes, (b) antigen-presenting cells (APCs), and (c) effector cells that function to eliminate antigens.

### Lymphocytes

The lymphocytes occupy a very special place among the leukocytes.

- They participate in immune reactions due to their ability to interact specifically with antigenic substances and to react to nonself antigenic determinants.
- They also contribute to the memory of the immune system.

The lymphocytes consist of heterogeneous populations of cells that differ greatly from each other in terms of origin, lifespan, preferred areas of settlement within the lymphoid organs, surface structure, and function. They differentiate from stem cells in the fetal liver, bone marrow, and thymus into two main functional classes: B cells and T cells. They are found in the peripheral blood and in all lymphoid tissues.

The lymphocytes are classified depending upon where they undergo their development and proliferation: (a) T lymphocytes or T cells undergoing development in the thymus or (b) B lymphocytes, or B cells undergoing development in the bone marrow. Differences between T cells and B cells are summarized in Table 16-1.

TABLE 16-1

Differences between T cells and B cells

Property	T cell	B cell
Antigen recognition receptors	T-cell receptors	Membrane-bound Ig
Surface glycoprotein antigens	CD3	CD19
IgM on surface	–	+
Immunoglobulin synthesis	–	+
IL-2, IL-4, IL-5, and gamma interferon synthesis	+	–
Receptor for Fc fragment of IgG	–	+
EAC rosette (receptors for C3 component of complement)	–	+
Sheep red blood cells (SRBC) rosette (E rosette)	+	–
Effect of cell-mediated immunity	+	–
Thymus-specific antigens	+	–
Maturation in bursa or its equivalent	–	+
Antigen receptor recognizes processed peptides with MHC	+	–

#### Thymus-derived cells

T lymphocytes, or T cells, are so designated because the thymus plays a key role in their differentiation. They are the key players in adaptive immunity. They participate directly in immune

responses as well as in orchestrating and regulating activities of other cells.

- T cells constitute 65–80% of the circulating pool of small lymphocytes.
- They are found in the inner subcortical regions but not in the germinal centers of the lymph nodes.
- They have a longer lifespan (months or years) than B lymphocytes.
- They are stimulated to divide on exposure to certain mitogens, such as phytohemagglutinin or concavalin A, the T cells can be stimulated to divide.
- Most human T cells have receptors for sheep erythrocytes on their surface and have the ability to form rosettes with them; this property is made use of for identifying T cells in a mixed population of cells.

The T lymphocytes perform two important groups of functions as follows:

**Regulation of immune responses:** Regulatory function is mediated primarily by helper (CD4<sup>+</sup>) T cells, which produce interleukins.

**Various effector functions:** Effector functions are mediated primarily by cytotoxic (CD8<sup>+</sup>) T cells, which kill allografts, tumor cells, and virus-infected cells. Depending on whether they have CD4 or CD8 proteins on their surface, T cells are subdivided into two major groups: CD4<sup>+</sup> T cells and CD8<sup>+</sup> T cells. Mature T cells have either CD4 or CD8 proteins, but never both.

### CD4<sup>+</sup> T cells

CD4 cells are also known as helper T (Th) cells. They constitute about 65% of peripheral T cells and are found mainly in the thymic medulla, tonsils, and blood. CD4 displayed on the surfaces of these T cells recognize a nonpeptide-binding portion of MHC class II molecules. Hence, CD4<sup>+</sup> T cells are restricted to the recognition of pMHC class II complexes. Helper T lymphocytes are involved in the induction and regulation of immune responses. CD4<sup>+</sup> T cells perform following helper functions:

- They help B cells to be transformed into plasma cells.
- They help CD8<sup>+</sup> T cells to become activated cytotoxic T cells.
- They help macrophages to mediate delayed type hypersensitivity reactions. The main functions of helper T cells are summarized in Box 16-1.

#### Box 16-1 Main function of helper T cells

1. Help in the antigen-specific activation of B cells and effector T cells.
2. Th-1 cytokines activate cytotoxic inflammatory and delayed hypersensitivity reactions.
3. Th-2 cells help in the production of interleukins which encourage production of antibodies especially IgE.
4. Th-2 cytokines are associated with regulation of strong antibody and allergic responses.

TABLE 16-2

Comparison of Th-1 cells and Th-2 cells

Features	Th-1 cells	Th-2 cells
Enhances cell-mediated immunity and delayed hypersensitivity	Yes	No
Enhances antibody production	No	Yes
Activation of cytotoxic T lymphocytes	Yes	No
Stimulated by IL-12	Yes	No
Stimulated by IL-4	No	Yes
Produces IL-2 and gamma interferon	Yes	No
Produces IL-4, IL-5, IL-6, and IL-10	No	Yes

All these functions are mediated by Th-1 cells and Th-2 cells—the two subpopulations of CD4<sup>+</sup> T cells:

- The Th-1 cells activate cytotoxic T cells by producing IL-2. They help in the development of hypersensitivity responses by producing primarily IL-2 and gamma interferon.
- The Th-2 cells perform B-cell helper function by producing primarily IL-4 and IL-5.

The balance between Th-1 and Th-2 cells is regulated by gamma interferon and IL-12. Gamma interferon inhibits the production of Th-2 cells, whereas IL-12 increases the number of Th-1 cells, thereby increasing host defense against microorganisms that are controlled by a delayed hypersensitivity reaction. Table 16-2 shows a comparison of Th-1 and Th-2 cells.

### CD8<sup>+</sup> T cells

CD8<sup>+</sup> T cells are also known as cytotoxic T (Tc) and suppressor T (Ts) cells. They account for approximately one-third of all mature CD3<sup>+</sup> cells. They are found mainly in the human bone marrow and gut lymphoid tissue.

CD8<sup>+</sup> T glycoprotein displayed on the surfaces of these T cells recognize a nonpeptide-binding portion of MHC class I molecules. Hence, CD8<sup>+</sup> T cells are restricted to the recognition of pMHC class I complexes.

CD8<sup>+</sup> T cells perform mainly cytotoxic functions. They kill (a) virus-infected cells, (b) allograft cells, and (c) tumor cells. T-cell mediated cytotoxicity is an apoptotic process that appears to be mediated by two different pathways:

- (i) One pathway involves the release of proteins known as perforins, which insert themselves in the target cell membranes forming channels. These channels allow the diffusion of enzymes (granzymes, which are serine esterases) into the cytoplasm. The exact way in which granzymes induce apoptosis has not been established, but granzyme-induced apoptosis is Ca<sup>2+</sup>-dependent.
- (ii) The other pathway depends on signals delivered by the cytotoxic cell to the target cell, which require cell-to-cell contact. This pathway is Ca<sup>2+</sup> independent.

The ratio of CD4<sup>+</sup> and CD8<sup>+</sup> T cells is approximately 2:1 in normal human peripheral blood. This may be significantly

TABLE 16-3

**Differences between helper T cells (CD4) and cytotoxic T (CD8) cells**

Helper T cells	Cytotoxic T cells
Carries CD4 marker	Carries CD8 cells
Helps or induces immune responses	Predominantly cytotoxic
Recognize antigen in association with class II MHC	Recognize antigen in association with class I MHC
Macrophages are activated to kill intracellular microorganisms by secreting cytokines	Destroy virus-infected and tumor cells directly

altered in immunodeficiency diseases, autoimmune diseases, and other disorders. Differences between CD4 and CD8 T cells are summarized in Table 16-3.

**Activation of T cells**

Recognition of complex on the surface of APCs, such as macrophages and dendritic cells, consisting of both the antigen and a class II MHC protein by TCR present on T cells, is most important for activation of helper T cells. Two signals are required to activate T cells:

- The interaction of the antigen and the MHC protein with the T-cell-receptor-specific antigen is the first signal required in the activation of process. IL-1 secreted by the macrophages is also necessary for efficient helper T-cell activation.
- A costimulatory signal is the second signal required for activation of T cells. In this signal, B7 protein present on the APC must interact with CD28 protein on the helper T cells. Following the costimulatory signal, IL-2 is produced by helper T cells, which is most crucial in producing a helper T cell capable of performing their regulatory, effector, and memory functions.

After activation of the T cells, a new different protein called CTLA-4 appears on the cell surface of T cells and binds to B7 by displacing CD28. The interaction of CTLA-4 with B7 inhibits T-cell activation by blocking IL-2 synthesis. This makes T cells to remain in a quiescent state and thereby plays an important role in T-cell homeostasis. On the other hand, mutant T cells that lack CTLA-4 and hence cannot be deactivated participate more frequently in autoimmune diseases.

**Memory T cells**

Memory T cells, as the name suggests, confer host immunity with the ability to respond rapidly and vigorously for many years after the initial exposure to a microbe or other foreign substances. The memory produced against a specific antigen shows the following characteristics:

1. Memory cells live for many years or have the capacity to reproduce them.
2. A large number of memory cells are produced, and so secondary response is enhanced and is greater than the primary response.

3. Memory cells are activated by small quantity of antigens and require less costimulation than do the naïve and unactivated T cells.
4. Activated memory cells produce greater amounts of interleukins than do naïve T cells when they are first activated.

**T-cell receptor**

T-cell receptor (TCR) for antigen consists of two polypeptides: alpha and beta. These two peptides are associated with CD3 proteins. Each T cell has a unique TCR on its surface, thereby implying that hundreds of millions of different T cells occur in each person. Activated T cells as well as activated B cells produce large number of cells specific for those antigens. T-cell alpha and beta polypeptides show many similarities to immunoglobulin heavy chain in the following ways:

- The genes coding for T-cell polypeptides are formed by rearrangement of multiple regions of DNA.
- There are V (variable), D (diversity), J (joining), and C (constant) segments that rearrange to provide diversity, thereby resulting in more than  $10^7$  different receptor proteins.
- RAG-1 and RAG-2 are the two genes that encode the recombinase enzymes that catalyze these gene rearrangements and are similar in T cells and B cells.

T cells, however, differ from immunoglobulins in the following ways:

- T cells have two chains rather than four chains in immunoglobulins.
- T cells recognize antigen only in conjunction with MHC proteins, whereas immunoglobulins recognize free antigens.

**Effect of superantigens on T cells**

Certain proteins such as staphylococcal enterotoxins and toxic shock syndrome toxins, and certain viral proteins, such as mouse mammary tumor virus, are called **superantigens**. These are called “super” because they activate a large number of helper T cells unlike “antigens”, which activate one or a few helper cells.

The superantigens play a very important role in pathogenesis of staphylococcal toxic shock syndrome caused by *Staphylococcus aureus*. In this condition, toxic shock syndrome toxin produced by *S. aureus* binds directly to class II MHC proteins without internal processing of the toxin. Subsequently, this toxin interacts with variable component of the beta chain ( $V\beta$ ) of the T-cell receptor of many T cells. The activation of T cells results in release of the interleukins, IL-2 from the T cells and tumor necrosis factor (TNF) from macrophages. These interleukins are responsible for many of the clinical presentations observed in toxin-mediated staphylococcal diseases.

**Effector functions of T cells**

T cells perform two important functions: (a) cytotoxicity and (b) delayed hypersensitivity.

**Cytotoxicity:** Cytotoxicity activity of T cells is required primarily to destroy virus-infected cells and tumor cells. It also plays an important role in graft rejection. The cytotoxic T cells kill the virus-infected cells:

- (a) By inserting perforins and granzymes (degrading enzymes) into the infected cell,
- (b) By the Fas–Fas ligand (FasL) interaction, and
- (c) By antibody-dependent cellular cytotoxicity (ADCC) mechanism.

**A. By inserting perforins and granzymes:** Perforins are inserted into the cells, leading to formation of a channel through the membrane. This results in the loss of cell contents and finally death of the cell. Granzymes are proteins that degrade proteins in the cell membrane, which also results in loss of cell contents. These enzymes also activate caspases that causes apoptosis, resulting in cell death.

**B. By the Fas–Fas ligand (FasL) interaction:** Cytotoxic T cells kill virus-infected cells by the FasL interaction. FasL is a protein which is expressed on the surface of many cells. When a cytotoxic TCR recognizes an epitope on the surface of virus-infected cells, FasL appears on the cytotoxic T cells. When Fas and FasL interact, it results in death or apoptosis of target cells. NK cells can also kill target cells by FasL interaction.

**C. By antibody-dependent cellular cytotoxicity (ADCC):** Virus-infected cells can also be killed by ADCC. In this process, target cells are killed by a combination of IgG and phagocytic cells. The antibody bound to the surface of the infected cells is recognized by IgG receptor on the surface of phagocytic cells (e.g., macrophages, NK cells) and the infected cell is killed. After killing of the virus-infected cells, the cytotoxic T cells are not damaged and can continue to kill other cells infected with the same virus. However, the cytotoxic T cells do not have any effect on free virus; they have effect only on virus-infected cells.

The cytotoxic T cells kill the tumor cells by a phenomenon called *immune surveillance*. New antigens are usually developed on surface of many tumor cells. These antigens bound to class I proteins are recognized by cytotoxic T cells, which are activated to proliferate by IL-2. The resultant clone of cytotoxic T cells can kill the tumor cells.

The cytotoxic T cells also play an important role in graft rejection. In this process, cytotoxic CD8 cells recognize the class I MHC molecules on the surface of the foreign cells. Helper CD4 cells recognize the foreign class II molecules on certain cells, such macrophages and lymphocytes in the graft. The activated helper cells secrete IL-2, which stimulates the cytotoxic cells to produce a clone of cells, which kills the cells in the allograft.

**Delayed hypersensitivity:** The CD4 cells particularly the Th-1 subset cells and macrophages mediate the delayed hypersensitivity reactions against antigens of many intracellular pathogens. The CD4 cells produce interleukins, such as gamma interferon, macrophage activation factor, and macrophage inhibition factor, which mediate delayed hypersensitivity reactions.

Th-1 cells produce IL-12-gamma interferon, which activates macrophages and thereby enhances the ability of the macrophages to kill *Mycobacterium tuberculosis*. The gamma interferon, therefore, plays an important role in the ability of host

immunity to control infections caused by *M. tuberculosis*, *Listeria monocytogenes*, and other intracellular microbes. A deficiency of CMI makes the person highly susceptible to infection by these microorganisms.

### Regulatory functions of T cells

T cells play key role in regulating antibody production and in suppression of certain immune responses.

1. **Regulation of antibody production:** Production of antibodies by B cells may be (a) T-cell dependent, requiring the participation of helper T cells (T-cell-dependent response), or (b) non-T-cell dependent (T-cell-independent response). In the T-cell-dependent response, all the classes of immunoglobulins, such as IgG, IgM, IgA, IgE, and IgD, are synthesized. The T-cell-dependent response produces memory B cells. In the non-T-cell dependent response (T-cell-independent response), only IgM antibody is synthesized. This response does not produce any memory cells. Hence, a secondary antibody response does not occur. In this response, the multivalent macromolecules, such as bacterial capsule polysaccharide are not effectively processed and presented by APCs; hence these do not activate helper T cells. This is because polysaccharides do not bind to class II MHC proteins, whereas peptide antigens do.
2. **Stimulation of helper and cytotoxic T cells to participate in the CMI:** In CMI, the antigen is processed by macrophages and is presented in conjunction with class II MHC molecules on the surface. These interact with the receptor on the helper T cells, which is then activated to produce IL-2, a T-cell growth factor that stimulates the specific helper and cytotoxic T cells to grow and participate in the CMI.
3. **Suppression of certain immune responses:** T cells have been shown to inhibit several immune-mediated diseases in animals. **Regulatory T cells (TR)**, also called suppressor T cells, is a subset of T cells and are associated with the suppression of certain immune responses. TR cells also called suppressor T cells are characterized by possessing CD25 marker and comprise 5–10% of the CD4<sup>+</sup> cells. The exact mechanism by which the regulatory cells suppress the immune response is not known. Imbalance in numbers or activity between CD4 and CD8 cells also leads to impairment of the cellular immune response of the host.

### ► Bone marrow-derived cells

The bone marrow-derived lymphocytes are known as B lymphocytes or B cells. Plasma cells are derived from mature B cells. Both B cells and plasma cells synthesize and secrete immunoglobulin.

### B cells

B lymphocytes or B cells are so designated because the bursa of Fabricius, a lymphoid organ located close to the caudal end of the gut in birds, plays a key role in their differentiation. A mammalian equivalent of the bursa is yet to be found. Here the early stages of maturation of these lymphocytes occur in the bone marrow.



## Key Points

- Nearly 30% of the recirculating small lymphocytes are composed of B cells.
- The B cells have a short lifespan of days or weeks. Nearly  $10^9$  B cells are produced every day.
- B cells are found in the germinal centers of the lymph nodes, in the white pulp of the spleen, and in the MALT.
- B cells perform two important functions. First, they differentiate into plasma cells and produce antibodies. Second, they can present antigen to helper T cells.

**Origin of B cells:** The clonal selection theory explains the origin of antibody formation. According to this postulation, each immunologically competent B cell possesses receptor for either IgM or IgD that can combine with one antigen or closely related antigens. After binding of the antigen, the B cell is activated to proliferate and form a clone of cells. Selected B cells are transformed to plasma cells that secrete antibodies specific for the antigen. Plasma cells synthesize the immunoglobulin with the same antigenic specificity as those carried by activated B cells. The same clonal selection also occurs with T cells.

B cell precursors, during embryogenesis, first proliferate and develop in the fetal liver. From there, they migrate to the bone marrow, the main site of B-cell maturation in the adults. Unlike T cells, they do not require the thymus for maturation. The Pre-B cells have only  $\mu$  heavy chains in the cytoplasm but do not have surface immunoglobulins and light chains. Pre-B cells are found in the bone marrow, while B cells are found in the circulation. B cells mature in two phases:

- Antigen-independent phase, which consists of stem cells and pre-B cells
- Antigen-dependent phase, which consists of the cells, such as activated B cells and plasma cells that proliferate on interactions of antigen with B cells.

B cells possess surface IgM, which acts as a receptor for antigen. Some B cells may also carry on their surface IgD as receptor for the antigen. There are many other molecules expressed on the surface of the B cells, which serve different functions. A few of them are B220, class II MHC molecules, CR1 and CR2, CD40, etc.

**Activation of B cells:** Activation of B cells to produce the full range of antibodies first requires recognition of the epitope by the T-cell-antigen receptor and the production of IL-4 and IL-5 by the helper T cells. In addition, it also requires other costimulatory interactions of CD28 on the T cells with B7 on the B cells. The CD28-B7 interaction is essential to produce IL-2. It also includes CD40L on the T cells, which must interact with CD40 on the B cells. The CD40L-CD40 interaction is essential for class switching from IgM to IgG and for switching between other immunoglobulin classes to take place.

**Effector functions of B cells:** Production of many plasma cells is the end result of activation of B cells. The plasma cells in turn produce large amounts of immunoglobulins specific for the epitope of the antigen. Some activated B cells also produce memory cells, which remain in a stage of quiescence for months

or years. Most memory B cells have surface IgG that acts as the antigen receptor, but some even have surface IgM. These quiescent memory cells are activated rapidly on reexposure to antigen. Memory T cells produce interleukins that facilitate antibody production by the memory B cells. The presence of these cells is responsible for the rapid appearance of antibody in the secondary immune responses.

## ▶ Antigen-presenting cells

Antigen presenting cells (APCs) include (a) macrophages and (b) dendritic cells.

### Macrophages

The mononuclear phagocytic system consists of monocytes circulating in the blood and macrophages in the tissues. The monocyte is considered a leukocyte in transit through the blood, which becomes a macrophage when fixed in a tissue. Monocytes and macrophages as well as granulocytes are able to ingest particulate matter (microorganisms, cells, inert particles) and for this reason are said to have phagocytic functions. The phagocytic activity is greater in macrophages, particularly after activation by soluble mediators released during immune responses, than in monocytes. Differentiation of a monocyte into a tissue macrophage involves a number of changes as follows:

1. The cell enlarges 5–10 folds.
2. Its intracellular organelles increase in number and complexity.
3. It acquires increased phagocytic ability.
4. It produces higher levels of hydrolytic enzymes.
5. It begins to secrete a variety of soluble factors.

Macrophage-like cells serve different functions in different tissues and are named according to their tissue location. Examples include (a) alveolar macrophages in the lung, (b) histiocytes in connective tissues, (c) Kupffer cells in the liver, (d) mesangial cells in the kidney, (e) microglial cells in the brain, and (f) osteoclasts in the bone.

For their participation in the immune reaction, the macrophages need to be stimulated and reach an “activated state.”

- Macrophages can be activated by various cytokines, components of the bacterial cell wall, and mediators of the inflammatory response.
- Gamma interferon produced by helper T cells is a potent activator of macrophages and is secreted by various cells in response to appropriate stimuli. Bacterial lipopolysaccharides (endotoxin), bacterial peptidoglycan, and bacterial DNA are the substances that also activate macrophages.
- Activated macrophages are more potent than normal macrophages in many ways, such as having greater phagocytic ability and increased ability to kill ingested microbes. They are better APCs, and they activate T-cell response in a more effective manner. By secreting various cytotoxic proteins, they help in eliminating a broad range of pathogens, including virus-infected cells, tumor cells, and intracellular bacteria.

**Functions of macrophages:** Macrophages perform three main functions: (a) phagocytosis, (b) antigen presentation, and (c) cytokine production (Table 16-4).

TABLE 16-4

## Important features of macrophages

Features	Mechanism
Phagocytosis	Ingestion and killing of microbes in phagolysosome
Antimicrobial and cytotoxic activities	<i>Oxygen-dependent killing:</i> by superoxides, nitric oxide, and hydrogen peroxide <i>Oxygen-independent killing:</i> by tumor necrosis factor, lysozyme, and hydrolytic enzymes
Antigen processing	Phagocytic antigen

**1. Phagocytosis:** Phagocytosis of bacteria, viruses, and other foreign particles is the most important function of macrophages. The macrophages on their cell surfaces have Fc receptors that interact with Fc component of the IgG, thereby facilitating ingestion of the opsonized organisms. They also have receptors for C3b, another important opsonin. After ingestion, the phagosome containing the microbe fuses with a lysosome. The microbe within the phagolysosome is killed by reactive oxygen, reactive nitrogen compounds, and lysosomal enzymes.

**2. Antigen presentation:** After ingestion and degradation of foreign materials, the fragments of antigen are presented on the macrophage cell surface in conjunction with class II MHC proteins for interaction with the TCR of CD4<sup>+</sup> helper T cells. Degradation of the foreign protein is stopped following the association of antigen with the class II MHC proteins in the cytoplasm. This is followed by transportation of the complex to the cell surface by transporter proteins.

**3. Cytokine production:** Macrophages produce several cytokines including the IL-1, TNF, and IL-8. IL-1 plays an important role in activation of helper T cells, while TNF plays as important mediator in inflammatory reactions. IL-8 attracts neutrophils and T cells to the site of infection.

### Dendritic cells

Dendritic cells are so named because of their many long, narrow processes that resemble neuronal dendrites, which make them very efficient at making contacts with foreign materials. They are primarily present in the skin (e.g., Langerhans cells) and the mucosa, from where they migrate to local lymph nodes for presentation of antigen to helper T cells.

#### Key Points

- Dendritic cells are very important for presentation of the antigen to T cells during primary immune response.
- They are bone marrow-derived cells that express class II MHC proteins and present antigen to CD4<sup>+</sup> T cells.
- They have little or no phagocytic activity.
- They also serve as professional APCs, although macrophages and B cells are the major APCs.

Four types of dendritic cells are known: (i) Langerhans cells, (ii) interstitial dendritic cells, (iii) myeloid cells, and (iv) lymphoid dendritic cells. All these cells constitutively express high levels of

both class II MHC molecules and members of the costimulatory B7 family. Following microbial invasion or during inflammation, mature and immature forms of Langerhans cells and interstitial dendritic cells migrate into draining lymph nodes, where they make the critical presentation of antigen to T<sub>H</sub> cells, which is required for the initiation of responses by those key cells.

### Follicular dendritic cells

Follicular dendritic cells are similar to the dendritic cells except for their sites of presence and functions. These cells are present in B-cell-containing germinal centers of the follicles in the spleen and lymph nodes. These cells do not present antigen to helper T cells, but combine with antigen-antibody complexes by Fc receptors found on their surfaces.

### Effector cells that function to eliminate antigens

#### Plasma cells

Plasma cells originate from terminally differentiated B cells. Plasma cells are oval or egg-shaped structures characterized by a stellate (star-like pattern) nucleus, nonstaining Golgi, and basophilic cytoplasm.

- The main function of the plasma cells is to produce and secrete all the classes of immunoglobulins into the fluids around the cells.
- They secrete thousands of antibody molecules per second, which are specific for the epitope of the antigen for a few days and then die.
- They, however, do not express membrane immunoglobulins.
- They divide very poorly, if at all, and are usually found in the bone marrow and in the perimucosal lymphoid tissues.
- They have a short lifespan of 30 days during which they produce large quantities of immunoglobulins.

#### Natural killer cells

Natural killer (NK) cells are morphologically described as large granular lymphocytes. These cells are called natural killer cells due to their ability to kill certain virally infected cells and tumor cells without prior sensitization. Their activities are not enhanced by exposure and are not specific for any virus. NK cells comprise approximately 5–10% of peripheral lymphocytes and are found in spleen and peripheral blood.

#### Key Points

- They lack both T cell (CD3) and B cell (surface immunoglobulin) markers.
- They lack immunologic memory and unlike cytotoxic T cells do not have any TCRs, and killing of target cells does not require recognition of MHC proteins.
- These cells do not carry antigen receptors of any kind, but can recognize antibody molecules bound to target cells and destroy those cells using the same general mechanisms involved on T-lymphocyte cytotoxicity (ADCC).
- They also have a recognition mechanism that allows them to destroy tumor cells and virus-infected cells.

**Box 16-2** Properties of natural killer cells

1. Large granular lymphocytes.
2. Lack T-cell receptor, CD3 proteins, and surface IgM and IgD.
3. Prior exposure does not increase the activity.
4. Thymus is not required for development.
5. Number remains normal in severe combined immunodeficiency disease.

Properties of NK cells are summarized in Box 16-2.

NK cells develop within the bone marrow and lack TCR, but possess another set of receptors called killer activation receptors and killer inhibition receptors. They also possess NK T cells, another subset of T cells, which share some functional characteristics with NK cells. These NK T cells unlike NK cells are stimulated by lipids, glycolipids, and hydrophobic peptides presented by a nonclassical class I molecule CD1D and secrete large amounts of cytokines, especially IL-4.

The main functions of the NK cells are to kill virus-infected cells and tumors. They do so by secreting cytotoxins, such as perforins and granzymes similar to those of cytotoxic T lymphocytes and also by FasL-mediated apoptosis. They kill the viruses without presence of specific antibodies but by a mechanism called ADCC. Both IL-12 and gamma interferons are potent activators of NK cells (Box 16-3).

**Granulocytes**

Granulocytes are a collection of white blood cells with segmented or lobulated nuclei and granules in their cytoplasm, which are visible with special stains. The granulocytes are classified as neutrophils, eosinophils, or basophils on the basis of cellular morphology and cytoplasmic-staining characteristics.

Both neutrophils and eosinophils are phagocytic, whereas basophils are not. Eosinophils play an important role in defense against parasitic infections, though their phagocytic role is significantly lower than neutrophils. Basophils, on the other hand, are nonphagocytic granulocytes that function by releasing pharmacologically active substances from their cytoplasmic granules. These substances play a major role in certain allergic responses.

Mast cells are the other granulocytic cells that have a role in the immune system. These cells are found in a wide variety of tissues, including the skin, connective tissues of various organs, and mucosal epithelial tissue of the respiratory, genitourinary, and digestive tracts. Like circulating basophils, these cells have large numbers of cytoplasmic granules that contain histamine and other pharmacologically active substances. Mast cells, together with blood basophils, play an important role in the development of allergies.

**Major Histocompatibility Complex**

The major histocompatibility complex (MHC) was first detected as the genetic locus encoding the glycoprotein

**Box 16-3** Functions of natural killer cells

1. Kill virus-infected cells and tumor cells.
2. Nonspecific killing of virus-infected cells and tumor cells.
3. Killing is independent of antigen presentation by MHC proteins.
4. Mechanism of killing is by perforins and granzymes, which cause apoptosis of target cell.
5. Killing is activated by failure of a cell to present antigen with class I MHC or by reduction of class I MHC proteins on the cell surface

molecules (transplantation antigens) responsible for the rapid rejection of tissue grafts transplanted between genetically nonidentical individuals. Gorer in 1930 was the first to identify the antigens responsible for allograft rejection that led to the discovery of major histocompatible complex. He demonstrated two blood group antigens (antigen 1 and antigen 2) in mice. Antigen 1 was found in all strains of mice, while antigen 2 was found in certain strains of mice and was responsible for allograft rejection. This was named H2 antigen and was found to be the major histocompatible antigen. This antigen was coded for by a closely linked multiallelic cluster of genes called the MHC, named as H-2 complex.

Histocompatible antigen denotes the cell surface antigens that induce immune responses to an incompatible host, resulting in allograft rejection. The MHC in humans is known as *human leukocyte antigens (HLA) complex*. In humans, these alloantigens are present on the surface of leukocytes and are called HLA and the set of genes encoding for them is named the HLA complex. Carbohydrate antigens of erythrocytes (blood groups) and glycoprotein antigens of cell membranes are the two major transplantation antigens of humans. Snell, Dausset, and Benacerraf (1980) were awarded the Nobel Prize for their work on MHC and genetic control of immune responses.

**HLA Complex**

In humans, the HLA complex of genes is located on short arm of chromosome 6 containing several genes that are critical to immune function (Fig. 16-3). The HLA complex of genes is classified into three classes as follows:

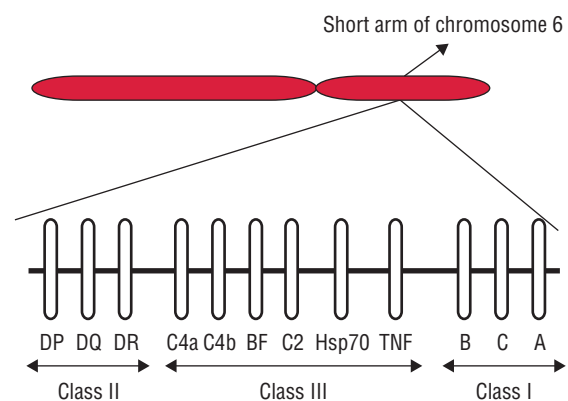

**FIG. 16-3.** A schematic diagram of HLA complex.

- Class I:** HLA-A, HLA-B, and HLA-C.
- Class II:** HLA-DR, HLA-DQ, and HLA-DP. All of these are present within HLA-D region of HLA complex.
- Class III:** Complement loci that encode for C2, C4, and factor B of complement system and TNFs alpha and beta.

A locus means the position where a particular gene is located on the chromosome. HLA loci are usually multiallelic, meaning that genes present on the locus can be any one of several alternative forms. There are 24 alleles at HLA-A locus and 50 at HLA-B locus. Each allele expresses for a distinct antigen. HLA system is pleomorphic and every person inherits one set of HLA genes from each parent.

The official Committee of the WHO has recommended a set of guidelines for nomenclature of the HLA system. Recognized alleles and their corresponding antigens are indicated by alphabet(s) and a number (e.g., HLA-A1, HLA-DR7, etc.).

The HLA genes encode a variety of enzymes and structural molecules essential for the activation and function of B and T cells. The genes encode MHC proteins that are classified into three groups or classes known as the class I, class II, and class III molecules.

### ► MHC class I molecules

These are glycoproteins found on the surface of virtually all nucleated cells in the body. Class I proteins are encoded by the HLA-A, -B, and -C loci. Approximately 20 different proteins are encoded by allelic genes at the A locus, 40 at the B locus, and 8 at the C locus (Table 16-5). The complete class I is composed of a transmembrane glycoprotein of 45,000 Da, heavy chain, noncovalently associated with a  $\beta_2$ -microglobulin (a non-HC-encoded polypeptide of MW 12,000 Da). The heavy chain like that of an immunoglobulin molecule has a variable and constant region. The variable region is highly pleomorphic. The polymorphism of these molecules is important in the recognition of self and nonself. The constant region of the heavy chain binds with the CD8 proteins of the cytotoxic T cells. Class I proteins are involved in graft rejection and cell-mediated cytotoxicity.

### ► MHC class II molecules

These are glycoproteins and unlike class I proteins, they have a restricted tissue distribution. They are chiefly found on macrophages, B cells, and other APCs, such as dendritic

cells of the spleen and Langerhans cells of the skin. Their expression on other cells (e.g., endothelial cells) can be induced by gamma interferon. They are highly polymorphic glycoproteins composed of two noncovalently associated transmembrane glycoproteins of MW of about 33,000 and 29,000 Da.

Class II proteins are encoded by the genes on the HLA-D locus. This locus retains control of immune responsiveness, and different allelic forms of these genes confer striking differences in the ability to mount an immune response against a given antigen. The class II MHC locus also includes genes encoding proteins involved in antigen processing, e.g., transporter associated with antigen processing (TAP). Class II proteins are primarily responsible for the graft-versus-host response and the mixed leukocyte response.

### ► MHC class III molecules

The class III MHC locus encodes complement proteins (C2, C4) of the classical pathways, properdin and factor B of the alternative pathway, and several cytokines.

## Biologic Importance of MHC

It is now known that MHC molecules bind peptide antigens and present them to T cells. Thus, these transplantation antigens are responsible for antigen recognition by the TCR. In this respect, the TCR is different from antibody.

- Antibody molecules interact with antigen directly; the TCR only recognizes antigen presented by MHC molecules on another cell, the APC. The TCR is specific for antigen, but the antigen must be presented on a self-MHC molecule.
- The TCR is also specific for the MHC molecule. If the antigen is presented by another allelic form of the MHC molecule *in vitro* (usually in an experimental situation), there is no recognition by the TCR. This phenomenon is known as **MHC restriction**.

Peptide antigens associated with class I MHC molecules are recognized by CD8<sup>+</sup> cytotoxic T lymphocytes, whereas class II-associated peptide antigens are recognized by CD4<sup>+</sup> helper T cells.

TABLE 16-5

Important features of some human MHC gene products

	Class I	Class II
Genetic loci (partial list)	HLA-A, -B, and -C	HLA-DP, -DQ, and -DR
Polypeptide composition	MW 45,000 Da + MW 12,000 Da	Light chain (MW 33,000 Da), light chain (MW 29,000 Da), light chain (MW 30,000 Da)
Cell distribution	All nucleated somatic cells and platelets	Antigen-presenting cells (macrophages, B cells, etc.) and activated human T cells
Present peptide antigens to	CD8 T cells	CD4 T cells
Size of peptide bound	8–11 residues	10–30 or more residues

## HLA Typing

HLA typing or tissue typing are usually performed to determine the closest MCH match between the donors and recipients before performing transplantation surgery. The methods commonly used in the laboratory include (a) molecular methods using DNA sequence, (b) serological assays, and (c) mixed lymphocyte culture (MLC) techniques. All these methods are used to determine the haplotype, i.e., the class I and class II alleles on both chromosomes of both the donor and recipient.

DNA probe and PCR are highly specific and sensitive methods used to detect the different alleles. Serological assays using a battery of antibodies specific for a different class I and class II proteins are also used to demonstrate the alleles. If these two methods fail to provide sufficient data, then additional information can be obtained by performing the MLC technique, also known as mixed lymphocyte reaction.

**Mixed lymphocyte reaction:** This test is performed by using stimulator lymphocytes from a potential donor,

which are first killed by irradiation. Then it is mixed with live responder lymphocytes from the recipient. The resultant mixture is then incubated in cell culture to allow DNA synthesis, which is detected by adding tritiated thymidine. The more the amount of DNA synthesis in the responder cells, the more foreign are the class II MHC protein of donor cells. Therefore, a large amount of DNA synthesis indicates that class II (HLA-D) MHC proteins of donor and recipients are not similar. This shows an unsatisfactory match between donor and recipients, thereby graft is likely to be rejected. Least production of DNA suggests the best donor and a good match between the donor and recipients. HLA typing is carried out:

- usually before tissue transplantation,
- for determination of paternity in case of dispute, and
- for finding association of HLA with diseases, such as association of HLA-B27 with ankylosing spondylitis and HLA-DR4 with rheumatoid arthritis.

# Immune Response

## Introduction

The adoptive immune system is developed in a host primarily to protect the host from harmful effects of pathogens and other foreign substances. The adoptive response can be antibody-mediated (humoral), cell-mediated (cellular), or both. An encounter with a microbial or viral agent usually elicits a complex variety of responses. There are two main sites where pathogens may reside in an infected host—extracellularly in tissue spaces or intracellularly within a host cell; the immune system has different ways of dealing with pathogens at these sites.

Humoral immunity acts mainly against extracellular pathogens, while cell-mediated immunity (CMI) acts against intracellular pathogens.

## Humoral Immunity

Humoral immunity is based on the action of antibodies and complement. It is directed primarily against:

- Extracellular bacteria, in particular exotoxin-producing bacteria, such as *Corynebacterium diphtheriae*, *Clostridium tetani*, etc.,
- Bacteria whose virulence is due to polysaccharide capsules (e.g., *Haemophilus influenzae*, *Neisseria meningitidis*, *Streptococcus pneumoniae*, etc.), and
- Certain viruses that cause infection through respiratory or intestinal tract. The humoral immunity also participates in the pathogenesis of hypersensitivity reactions and certain autoimmune diseases.

Production of antibodies is the main feature of humoral immune responses. The production of antibodies follows a characteristic pattern as follows:

- 1. Lag phase:** This is the immediate phase following exposure to antigen. During this phase, no antibodies are detected in circulation.
- 2. Log phase:** This is the next phase characterized by a steady rise in antibody titers in the circulation.
- 3. Plateau:** This is a phase of equilibrium between antibody synthesis and catabolism.
- 4. Phase of decline:** This phase is characterized by an increase in the catabolism of antibodies compared to the production of antibodies, leading to a fall in antibody titer in the circulation. Humoral immune response is of two types: primary and secondary.

## Primary Response

During the primary response, when an individual encounters an antigen for the first time, antibody response to that antigen is detectable in the serum after a longer lag period than occurs in the secondary response. The serum antibody concentration continues to rise for several weeks and then declines; it may drop to very low levels. During this primary response, a small clone of B cells and plasma cells specific for the antigen are formed.

The lag period is typically of 7–10 days duration but can be longer, even for weeks, depending on the nature of the antigen. For example, the lag phase may be as long as 2–3 weeks with some antigens, such as diphtheria toxoid, while it may be as short as a few hours with pneumococcal polysaccharide. The lag period also depends on dose of the antigen and the route of administration whether oral or parenteral.

IgM is the first antibody to be formed, followed by IgG, IgA, or both. IgM levels tend to decline sooner as compared to IgG levels (Fig. 17-1).

## Secondary Response

The antibody response is typically more rapid in the secondary response, due to second encounter with the same antigen, or a closely related “cross-reacting” antigen, months or years after the primary response. The lag period is typically very short (only 3–5 days). The level of antibody is also much higher than that during the primary response.

These changes in secondary response are attributed to the persistence of antigen-specific “memory cells” following the first contact with the antigen. These memory cells proliferate in large numbers to produce large clones of specific B cells and plasma cells that mediate the secondary response. In the secondary response:

- The amount of IgM produced is qualitatively similar to that produced after the first contact with the antigen; however, much more IgG is produced and the level of IgG tends to persist much longer than in the primary response.
- Furthermore, such antibody tends to bind antigen more firmly (i.e., to have higher affinity) and thus to dissociate less easily. Improved antibody binding is due to mutations that occur in the DNA that encodes the antigen-binding site. This process is called *somatic hypermutation*.

## Fate of Antigen in Tissues

Route of administration of antigen affects the site of localization of these antigens in the body. For example, most of the

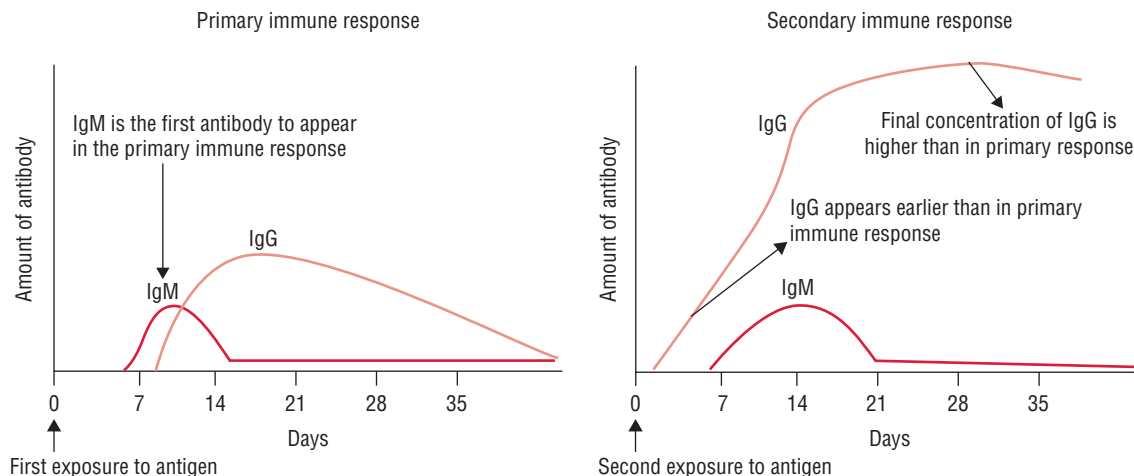

FIG. 17-1. A schematic diagram showing primary and secondary response.

antigens introduced subcutaneously are localized mainly in the draining lymph nodes and only a small amount is there in the spleen. On the other hand, most of the antigens introduced intravenously are localized in the spleen, liver, bone marrow, kidney, and lungs but not in lymph nodes. Approximately, three-fourths of these antigens are broken down by reticuloepithelial cells and are excreted out in the urine.

## Production of Antibodies

Synthesis and production of antibodies typically is dependent on complex interaction of three cells: (a) macrophages, (b) helper T cells, and (c) B cells.

Antigens are presented to immunocompetent cells by antigen presenting cells (APCs), such as macrophages and dendritic cells. Processing by macrophages appears to be a prerequisite for formation of antibodies against many T-cell-dependent antigens, such as proteins and erythrocytes. However, antibody production does not require macrophage participation in case of T-cell-independent antigens. Both the macrophages and dendritic cells present the antigen either native or processed at the cell surface. Macrophages play a key role by modulating the optimum dose of antigen presented to lymphocytes to induce the immune responses.

After processing of antigens by a macrophage, fragments of antigen appear on surfaces of macrophages in association with class II MHC proteins. The antigen-class II MHC protein complex binds to specific receptors present on the surface of helper T cells. Subsequently, these helper T cells produce cytokines that activate B cells, producing antibodies that are specific for that antigen. The activated cytokines are interleukin-2 (T-cell growth factor), interleukin-4 (B-cell growth factor), and interleukin-5 (B-cell differentiation factor). The activated B cells undergo clonal proliferation and differentiate to form plasma cells, which then produce specific immunoglobulins (antibodies). Major host defense functions of antibodies include neutralization of toxins and viruses and opsonization (coating) of the pathogen, which aids its uptake by phagocytic cells.

Although helper T cells play a key role in the formation of antibodies, certain substances (e.g., polysaccharides) can activate B cells directly without the help of T cells. Such substances are called T-cell-independent antigens. These antigens, however, induce only the production of IgM antibodies but not other antibodies by B cells. This is because B cells require interleukins 4 and 5 to switch classes to produce IgG, IgA, and IgE. These interleukins 4 and 5 are produced by T helper cells only.

B cells perform two important functions: First, they recognize antigens with their surface IgM that acts as an antigen receptor; second, they present epitopes to helper T cells in association with class II MHC proteins. IgM antigen receptor on the B cells recognizes foreign proteins as well as lipids, carbohydrates, DNA, RNA, etc. On the other hand, class II MHC proteins present protein fragments to the helper T cells. The IgM antigen receptor binds with this wide variety of molecules that stimulate B cells to produce antibodies against all the molecules possible.

## Theories of antibody formation

There are two sets of theories of antibody formation. These are instructive theory and selective theories.

### Instructive theory

Instructive theory suggests that an immunocompetent cell is capable of synthesizing antibodies of all specificity. The antigen directs the immunocompetent cell to produce complementary antibodies. Two instructive theories are postulated as follows:

**Direct template theory:** This theory was first postulated by Breinl and Haurowitz (1930). They suggested that a particular antigen or antigenic determinants would serve as a template against which antibodies would fold. The antibody molecule would thereby assume a configuration complementary to antigen template.

**Indirect template theory:** This theory was first postulated by Burnet and Fenner (1949). They suggested that the entry of antigenic determinants into the antibody-producing cells induced a heritable change in these cells. A genocopy of the antigenic

determinant was incorporated in genome and transmitted to the progeny cells. However, this theory that tried to explain specificity and secondary responses is no longer accepted.

### Selective theories

Three selective theories were postulated as follows:

**Side chain theory:** This theory was proposed by Ehrlich (1898). According to this theory, immunocompetent cells have surface receptors that are capable of reacting with antigens, which have complementary side chains. When antigens are introduced into host, they combine with those cell receptors that have a complementary fit. This inactivates the receptors. There is an overproduction of the same type of receptors that circulate as antibodies, as a compensatory mechanism.

**Natural selection theory:** This theory was proposed by Jerne (1955). According to this theory, during the embryonic life, millions of globulin molecules were formed against all possible range of antigens. The antigen when introduced to the host combines selectively with the globulin molecule that has the nearest complementary fit. The globulin with the combined antigen stimulates antibody-forming cells to produce the same type of antibody.

**Clonal selection theory:** Burnet (1957) suggested that immunological specificity existed in the cell but not in the serum and proposed the most acceptable clonal selection theory. According to this theory, a large number of clones of immunological competent cells bearing specific antibody patterns are produced during fetal development by a process of somatic mutations of immunological competent cells (ICCs) against all possible antigens.

This theory suggests that an individual ICC expresses membrane receptors that are specific for a distinct antigen. This unique receptor specificity is determined before the lymphocyte is exposed to antigen. Binding of antigen to its specific receptor activates the cell and leads to cellular proliferation to form clones, synthesizing the antibody.

The clonal selection theory is most widely accepted and provides a framework for better understanding of the specificity, immunological memory, and the property of recognition of self and nonself by adoptive immunity.

### ► Factors affecting production of antibodies

Many factors affect the production of antibodies. These factors are discussed below:

#### Genetic factors

Genetic factors influence the response of the host to antigen. Persons responding to antigens are called responders, while persons not responding are called nonresponders. These differences are controlled genetically and are being controlled by immune response (Ir) gene located in the short arm of the 6th chromosome.

#### Age

The embryo and the infant, at birth, are not fully immunologically competent. Full competence is achieved by about the age

of 5–7 years for IgG and 10–15 years for IgA by the development of lymphoid organs.

#### Nutritional status

Malnutrition affects both the humoral and cell-mediated immunities. Deficiencies of amino acid and vitamins have shown to decrease the production of antibodies.

#### Route of antigen

Induction of immune response in a host depends on the route of administration of the antigen. Parenteral administration of the antigen induces a better immune response than the oral or nasal routes.

#### Dose of antigen

A minimum critical dose of antigen is essential to elicit an optimum immunological response. A very high or small dose fails to stimulate the immune system. This phenomenon is referred to as *immunological paralysis*.

#### Multiple antigens

Antibody responses vary when two or more antigens are administered simultaneously. Antibody responses to one or more of them may be diminished due to antigenic competition, or enhanced as seen after vaccination with triple vaccine (diphtheria, pertussis, and tetanus), or may be similar. Hence, the nature and relative proportions of different antigens should be carefully adjusted for optimal effect.

#### Adjuvants

Adjuvants are the substances that enhance the immunogenicity of an antigen. The adjuvants delay the release of an antigen from the site of injection and prolong the antigenic stimulus. The substances that are used as adjuvants include:

- (a) Freund's incomplete adjuvant (protein antigen incorporated in water phase of water in oil emulsion);
- (b) Freund's complete adjuvant (incomplete adjuvant along with suspension of killed tubercle bacilli);
- (c) Aluminum salts both phosphate and hydroxide; and
- (d) Others, such as silica particles, beryllium sulfate, endotoxin, etc.

### Key Points

An adjuvant functions in the following ways:

- It causes sustained release of antigen from depot.
- It enhances immunogenicity of nonantigenic substances.
- It increases the concentration and persistence of antibodies.
- It induces and enhances CMI.
- It activates macrophages.
- It stimulates lymphocytes nonspecifically.



## Immunosuppressive agents

Immunosuppressive agents are those that suppress immune response. They are used in transplantation surgery and in situations that require suppression of host immunity. The agents are as follows:

**X-irradiation:** Sublethal dose of irradiation is toxic to replicating cells and is used to suppress antibody formation. Antibody production ceases after 24 hours of receiving irradiation.

**Radiometric drugs:** These include alkylating agents (such as cyclophosphamide, nitrogen mustard, etc.), which suppress antibody production. Cyclophosphamide, given for 3 days, completely suppresses the antibody response. It selectively prevents replication of B cells.

**Corticosteroids:** Corticosteroids are anti-inflammatory drugs that diminish the responsiveness of both B and T cells. They alter maturation of activated cells by suppressing the production of interleukins. They suppress delayed hypersensitivity, but in therapeutic doses for a short period, they have little effect on the production of antibodies.

**Antimetabolites:** These include folic acid antagonists (such as methotrexate); analogs of purine (6-mercaptopurine and azathioprine); and analogs of cytosine (cytosine arabinose); and uracil (5-fluorouracil). These substances inhibit DNA and RNA synthesis, thereby inhibiting the cell division and differentiation, which is essential for cellular and humoral immune responses. These are usually used for prevention of graft rejection.

**Antilymphocyte serum:** Antilymphocyte serum (ALS) is a heterogeneous antiserum raised against T lymphocytes. The ALS acts mainly against circulating lymphocytes but not against lymphocytes in lymphoid organs. It is mainly used to prevent graft rejection in transplantation surgery.

## Monoclonal Antibodies

Antibodies that arise from a single clone of cells (e.g., myeloma) are homogenous and are called monoclonal antibodies. For example, in multiple myeloma, antibodies are produced by a single clone of plasma cells against a single antigenic determinant, and hence antibodies are monoclonal. The monoclonal antibodies differ from polyclonal antibodies, which are heterogeneous and are formed by several different clones of plasma cells in response to antigen.

### ► Method of production of monoclonal antibodies

Kohler and Milstein (1975) were the first to describe a method for production of monoclonal antibodies against a desired antigen for which they were awarded Nobel Prize in 1984. Monoclonal antibodies are produced by fusion of myeloma cells with antibody-producing cells, resulting in production of hybridomas. Such hybridomas produce virtually unlimited quantities of antibodies that are useful in research and diagnostics. In this procedure, mouse splenic lymphocytes are first fused with mouse myeloma cells to produce hybrid cells or hybridomas. Myeloma cell provides the hybrid cell immortality,

whereas splenic plasma cell provides the antibody-producing capacity. These hybridomas can be maintained indefinitely in culture and continue to produce monoclonal antibodies. Hybridoma cells are prepared in following ways (Fig. 17-2):

- First, an animal (e.g., mouse) is immunized with the antigen of interest.
- Spleen cells (lymphocytes) are then fused with mouse myeloma cells and grown in culture, which are deficient in the enzyme hypoxanthine phosphoribosyl transferase (HPRT).
- Fusion of the cells is facilitated by addition of certain chemicals, such as polyethylene glycol. The fused cells are grown in a special culture medium (HAT medium) that supports the growth of the fused hybrid cells but not of the parent cells.
- Finally, the resulting clones of cells are screened for the production of antibody to the antigen of interest.
- These clones are then selected for continuous cultivation. The hybridomas can be maintained indefinitely and will continue to produce monoclonal antibodies.

Human monoclonal antibodies, such as chimeric antibodies, have been produced with modification of the original technique for therapeutic use, since mouse monoclonal antibodies are not suitable. The chimeric antibodies consisting of human constant regions and mouse variable regions are being prepared for use in treatment of leukemia. Chimeric antibodies are also used to kill tumor cells either by delivering toxins, such as diphtheria to tumor cells, or by killing tumor cells through complement-mediated cytotoxicity.

### Key Points

- Monoclonal antibodies are now used widely in research and diagnostics.
- They are used in various clinical situations, such as treatment of cancer and autoimmune diseases.
- They are used in inducing immune suppression in transplant surgery, and in the prevention of infectious diseases.

## Function of Antibodies

Antibodies are the primary defense against infectious pathogens or their products. Antibodies can be induced in the host actively by use of vaccines or acquired passively for conferring immediate protection against the pathogen. For example, hyperimmunized sera containing readymade antitoxins against toxins of tetanus, botulism, or diphtheria are given to neutralize the actions of these toxins immediately in the body. Also, hyperimmune sera containing high titer of specific antibodies are given to inhibit attachment and replication of rabies and hepatitis A and B viruses early during the period of incubation. The functions of the antibodies can be summarized as follows:

**Neutralization:** By binding to the pathogen or foreign substance, antibodies can block the binding of the pathogen with their targets. For example, antibodies to bacterial toxins can prevent the binding of the toxin to host cells, thereby rendering the toxin ineffective. Similarly, antibody binding to a

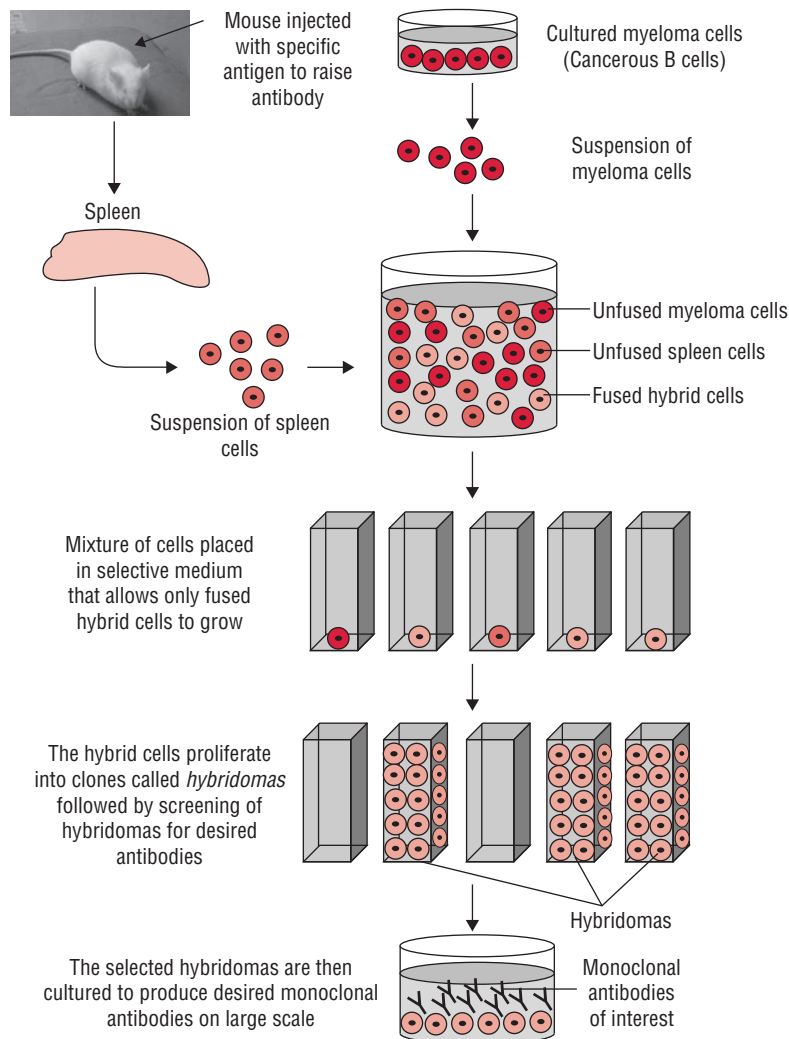

FIG. 17-2. A schematic diagram showing the production of monoclonal antibodies.

virus or bacterial pathogen can block the attachment of the pathogen to its target cell, thereby preventing infection or colonization.

**Opsonization:** Antibody binding to a pathogen or foreign substance can opsonize the material and facilitate its uptake and destruction by phagocytic cells. The Fc region of other antibody interacts with Fc receptors on phagocytic cells, rendering the pathogen more readily phagocytosed.

**Complement activation:** Activation of the complement cascade by antibody can result in lysis of certain bacteria and viruses. In addition, some components of the complement cascade (e.g., C3b) opsonize pathogens and facilitate their uptake via complement receptors on phagocytic cells.

### Tests for Detection of Humoral Immunity

The measurement of IgG, IgM, and IgA in the patient's serum is the primary method for detection of humoral immunity. Radial immunodiffusion and immunoelectrophoresis are the methods frequently employed for measurement of antibodies.

### Cell-Mediated Immunity

Cell-mediated immunity (CMI) is a specific type of acquired immune response not mediated by antibodies but by sensitized T cells. This form of immunity is transferred from donor to recipient, not with antisera but with intact lymphocytes; hence it is called cell-mediated immune reaction. CMI performs the following immunological functions:

1. It confers immunity in diseases caused by obligate intracellular bacteria (*Mycobacterium tuberculosis*, *Mycobacterium leprae*, *Brucella*, etc.), viruses (small pox, measles, mumps, etc.), fungi (*Histoplasma capsulatum*, *Blastomyces dermatitidis*, *Coccidioides immitis*, etc.), and parasites (*Toxoplasma gondii*, *Leishmania donovani*, etc.).
2. It participates in immunological surveillance and immunity against cancer.
3. It plays an important role in pathogenesis of delayed hypersensitivity reactions and in pathogenesis of certain autoimmune diseases, such as autoimmune thyroiditis, encephalitis, etc.

## Induction of CMI

Antigen processing and presentation are the means by which antigens become associated with self-MHC molecules for presentation to T cells with appropriate receptors. Proteins from exogenous antigens, such as bacteria, are internalized via endocytic vesicles into APCs, such as macrophages. Then, they are exposed to cellular proteases in intracellular vesicles. Peptides, approximately 10–30 amino acid residues in length, are generated in endosomal vesicles. The endosomal vesicles can then fuse with exocytic vesicles containing class II MHC molecules. Induction of CMI involves sequence of events, which is explained below.

### ► Presentation of foreign antigen by APCs to T lymphocytes

Induction of CMI begins with presentation of foreign antigen by APCs to T lymphocytes. T-cell receptors (TCRs), which are antigen recognition receptors, are present on T lymphocytes, and recognize foreign antigen and a self-MHC molecule on the surface of APCs. Subsequently, the sensitized T lymphocytes undergo blast transformation, clonal proliferation, and differentiation into memory cells and effector cells, such as Th, Tc, Td, and Ts. Finally, the lymphokines, which are biologically active products responsible for various manifestations of CMI, are released by the activated lymphocytes.

### ► Recognition of antigen by T cells

T cells recognize antigens only when presented with MHC molecules. The combination of foreign antigen and class I MHC molecule is recognized by CD8<sup>+</sup> cells. These CD8<sup>+</sup> cells after recognition differentiate into Tc and Ts lymphocytes. On the other hand, CD4<sup>+</sup> cells recognize the combination of antigen and class II MHC antigen, after which they are differentiated into Th and Td cells. The class II MHC molecules are synthesized, as for other membrane glycoprotein, in the rough endoplasmic reticulum and then proceed out through the Golgi apparatus. A third polypeptide, the invariant chain (Ii), protects the binding site of the class II dimer until the lowered pH of the compartment created after fusion with an endosomal vesicle causes a dissociation of the Ii chain. The MHC class II peptide antigen complex is then transported to the cell surface for display and recognition by a TCR of a CD4 T cell.

The lymphocyte recognizes antigen and class I MHC molecule and gets attached to the target cells. Endogenous antigens such as cytosolic viral proteins synthesized in an infected cell are processed for presentation by class I MHC molecule. In brief, cytosolic proteins are broken down by a peptidase complex known as the proteasome. The cytosolic peptides gain access to nascent MHC class I molecules in the rough endoplasmic reticulum via peptide transporter systems (transporters associated with antigen processing; TAPs). The TAP genes are also encoded in the MHC.

The binding groove of the class I molecule is more constrained than that of the class II molecule; for that reason, shorter peptides are found in class I than in class II MHC molecules.

### ► Release of cytokines by Tc lymphocytes

This stimulates Tc lymphocytes to release cytokines, resulting in the lysis of the target cells. The T cells then detach from the target cells and attach with other target cells, and the same process is repeated. Interferon-gamma synthesized and secreted by Tc lymphocytes possibly also contributes for macrophage activation in some way.

## Cytokines

Cytokines are biologically active substances secreted by monocytes, lymphocytes, and other cells and are actively involved in innate immunity, adoptive immunity, and inflammation. They actively take part in a wide range of biological activities varying from chemotaxis to activation of specific cells.

Cytokines were initially identified as products of immune cells that act as mediators and regulators of immune processes. Many cytokines are now known to be produced by cells other than immune cells, and they can have effects on nonimmune cells as well. Cytokines are currently being used clinically as biological response modifiers for the treatment of various disorders.

Cytokines are not typically stored as preformed proteins. Rather their synthesis is initiated by gene transcription and their mRNAs are short-lived. They are produced as needed in immune responses. Many individual cytokines are produced by many cell types and act on many cell types (i.e., they are pleiotropic), and in many cases cytokines have similar actions (i.e., they are redundant). Redundancy is due to the nature of the cytokine receptors.

### ► Categories of cytokines

Cytokines can be grouped into different categories based on their functions or their source, but it is noteworthy that because they can be produced by many different cells and act on many different cells (Table 17-1), any attempt to categorize them will be subject to limitations. Cytokines may be categorized as follows:

1. Mediators affecting lymphocytes.
2. Mediators affecting macrophages and monocytes.
3. Mediators affecting polymorphonuclear leukocytes.
4. Mediators affecting stem cells.
5. Mediators produced by macrophages that affect other cells.

### *Mediators affecting lymphocytes*

**Interleukin-1 (IL-1):** It is a protein produced mainly by activated macrophages and monocytes. Its production is stimulated by antigens, toxins, and inflammatory processes but inhibited by cyclosporine and corticosteroids. It is an important interleukin, which mediates a wide range of metabolic, physiological, inflammatory, and hematological activities. It has many important functions, which are given below:

- It activates a wide range of target cells including T and B lymphocytes, neutrophils, epithelial cells, and fibroblasts to proliferate, differentiate, or synthesize specific products. For example, it stimulates helper T cells to produce IL-2, and stimulates B cells to proliferate and synthesize antibodies, etc.
- It acts on the hypothalamus to cause fever associated with infections and other inflammatory reactions.

TABLE 17-1

Important functions of the main cytokines

Cytokine	Source	Functions
IL-1	Macrophages	Activates helper T cells, causes fever
IL-2	Th-1 cells	Activates helper, cytotoxic T cells and B cells
IL-3	Th cells, NK, and mast cells	Supports growth and differentiation, stimulates histamine release
IL-4	Th-2 cells	Stimulates B-cell growth, increases isotype switching and IgE, up-regulates class II MHC expression
IL-5	Th-2 cells	Stimulates B-cell differentiation, increases eosinophils and IgA
Interferon- $\alpha$	Leukocytes	Inhibits viral replication
Interferon- $\beta$	Fibroblasts	Inhibits viral replication
Interferon- $\gamma$	Th-1, Tc, and NK cells	Inhibits viral replication, increases expression of class I and II MHC, stimulates phagocytosis and killing by macrophages and NK cells
Tumor necrosis factor	Macrophages	Activates neutrophils and increases their adhesion to endothelial cells, mediates septic shock, causes necrosis of tumors, lipolysis, wasting, antiviral and antiparasitic effects
Transforming growth factor- $\beta$	Platelets, mast cells, and lymphocytes	Induces increased IL-1 production, induces class switch to IgA, limits inflammatory response, and promotes wound healing

**Interleukin-2 (IL-2):** IL-2 is a protein produced mainly by helper T cells. It is a major T-cell growth factor. It stimulates both helper and cytotoxic T cells to grow. It also promotes the growth of B cells and can activate natural killer (NK) cells and monocytes.

IL-2 acts on T cells in an autocrine fashion. Activation of T cells results in expression of IL-2R and the production of IL-2. The IL-2 binds to the IL-R and promotes cell division. When the T cells are no longer being stimulated by antigen, the IL-2R will eventually decay and the proliferative phase ends.

**Interleukin-4 (IL-4):** It is a protein produced mainly by helper T cells and macrophages. It stimulates the development of Th-2 cells, the subset of helper T cells that produces IL-4 and IL-5 and enhances humoral immunity by producing antibodies. It is also required for class (isotype) switching from one class of antibodies to another within antibody-producing cells.

**Interleukin-5 (IL-5):** It is a protein produced by helper T cells. It promotes the growth and differentiation of B cells and eosinophils. It enhances the synthesis of IgA and also stimulates the production and activation of eosinophils.

**Interleukin-6 (IL-6):** It is a protein produced by helper T cells and macrophages. It stimulates the production of acute phase proteins by the liver. It also acts on the hypothalamus to cause fever.

**Other interleukins:** IL-10, IL-12, and IL-13 are the other interleukins that affect lymphocytes. IL-10 is produced by activated macrophages and Th-2 cells. It is predominantly an inhibitory cytokine. It inhibits production of type I interferon. It inhibits production of interferon-gamma by Th-1 cells, which shifts immune responses toward a Th-2 type. It also inhibits cytokine production by activated macrophages and the expression of class II MHC and costimulatory molecules on macrophages, resulting in a depression of immune responses.

IL-12 is produced by activated macrophages and dendritic cells. It stimulates the production of interferon-gamma and

induces the differentiation of Th cells to become Th-1 cells. In addition, it enhances the cytolytic functions of Tc and NK cells.

IL-13 is produced by Th-2 cells. It is associated with pathogenesis of allergic airway disease (asthma). It is involved in the occurrence of hyper-responsiveness seen in asthma.

**Transforming growth factor-beta (TGF- $\beta$ ):** It is produced by T cells and many other cell types. It is primarily an inhibitory cytokine. It inhibits the proliferation of T cells and the activation of macrophages. It also acts on polymorphonuclear leukocytes and endothelial cells to block the effects of proinflammatory cytokines. In essence, it suppresses the immune response when it is not required after an infection, and thereby it promotes the healing process.

### Mediators affecting macrophages and monocytes

Chemokines are a subtype of cytokines of low molecular weight and with a characteristic structural pattern. More than 50 chemokines varying in size from 68 to 120 amino acids have been identified. The alpha-chemokines, such as IL-8 are produced by activated mononuclear cells, which attract neutrophils. The beta-chemokines, such as RANTES (regulated upon activation, normal T-cell expressed and secreted) and MCAF (monocyte chemotactic and activating factor), are produced by activated T cells and attract macrophages and monocytes.

Chemokines are produced by endothelial cells, resident macrophages and various cells present at the site of infection:

- They attract either macrophages or neutrophils to the site of infection, hence are involved in chemical-induced migration of leukocytes—a process called chemotaxis. Specific receptors for chemokines are present on the surface of monocytes and neutrophils.
- They also facilitate migration of white cells into the tissue to reach the infected area. They do so by activating integrins

on the surface of neutrophils and macrophages that bind to the intercellular adhesion molecule (ICAM) proteins on the surface of the endothelium.

### Mediators affecting polymorphonuclear leukocytes

**Tumor necrosis factor (TNF- $\alpha$ ):** It is produced by activated macrophages in response to microbes, especially the lipopolysaccharide of Gram-negative bacteria. It is an important mediator of acute inflammation. It mediates the recruitment of neutrophils and macrophages to sites of infection by stimulating endothelial cells to produce adhesion molecules. It also produces chemokines, which are chemotactic cytokines. TNF- $\alpha$  also acts on the hypothalamus to produce fever, and it promotes the production of acute phase proteins.

**Chemokines and other chemotactic factors:** Chemokines and other chemotactic factors attract selectively neutrophils, basophils, and eosinophils to the site of infection. For example, IL-8 and C5a component of the complement attract specifically neutrophils.

**Leukocyte-inhibiting factor:** It inhibits migration of neutrophils, thereby retaining the cells at the site of infection.

### Mediators affecting stem cells

Mediators affecting stem cells include (a) IL-3, (b) granulocyte macrophage colony-stimulating factor (GM-CSF), and (c) granulocyte colony-stimulating factor (G-CSF).

- IL-3 produced by helper T cells suppresses the growth and differentiation of bone marrow stem cells.
- GM-CSF produced by macrophages and T lymphocytes stimulates the growth of granulocytes.
- G-CSF is produced by macrophages, fibroblasts, and endothelial cells. It facilitates development of neutrophils from stem cells, and hence used to prevent infection in patients receiving cancer chemotherapy.

### Mediators produced by macrophages that affect other cells

**Tumor necrosis factor (TNF- $\alpha$ ):** TNF- $\alpha$ , as the name suggests, causes death and necrosis of certain tumor cells in experimental animals. It is also called *cachectin* because it inhibits lipoprotein lipase in adipose tissues, thereby reducing the utilization of fatty acids, leading to cachexia. TNF- $\alpha$  performs many functions:

- It activates respiratory burst within neutrophils, thereby enhancing killing activities of phagocytes.
- It facilitates adhesion of neutrophils to endothelial cells of blood vessels.
- It also stimulates growth of B cells and increases synthesis of lymphokines by helper T cells.

**Macrophage migration inhibition factor (MIF):** It is produced by macrophages in response to action by endotoxin. It retains the macrophages at the site of infection. It plays an important role in the induction of septic shock.

**Nitric oxide (NO):** It is produced by macrophages in response to action by endotoxin. NO causes vasodilatation, thereby inducing hypotension in septic shock.

## Tests for Detection of CMI

The CMI can be detected by *in vivo* and *in vitro* tests as follows:

### ► CMI in vivo tests

Skin tests are useful to detect delayed hypersensitivity reaction to common antigens that come in contact with the body. Purified protein derivative in tuberculin test, dinitrochlorobenzene, or dinitrofluorobenzene are the antigens used for the skin testing.

Most of the normal people respond with delayed type reactions to these skin antigens. Absence of reactions to these skin tests suggests impairment of the CMI.

### ► CMI in vitro tests

Many *in vitro* tests are available for detection of CMI. These are:

**1. Migration inhibition factor (MIF) test:** This test is performed to determine the CMI by making a semiquantitative assessment of the migration inhibition of leukocytes. This test depends on the principle that cultured T cells produce macrophage migration inhibition factor on exposure to the antigen to which they are sensitized. In this test, human peripheral leukocytes are incubated in capillary tubes in culture chamber containing culture fluid. The leukocytes, in the absence of antigen, migrate out to the open end of the tube to form a fan-like pattern. In the presence of antigen, the leukocytes are prevented from migrating.

**2. Lymphocyte blast transformation:** A large number of T cells undergo blast transformation when exposed to certain mitogens, such as the phytohemagglutinin and concavalin. Sensitized T lymphocytes are transformed into large blast cells with great increase in the synthesis of DNA, on exposure to the specific antigen. An increase in DNA synthesis is then measured by incorporation of tritiated thymidine.

**3. Enumeration of T cells, B cells, and subpopulation:** Fluorescence-activated cell sorter is used to count the number of each type of cells, whether T or B cells. In this method, cells are labeled with monoclonal antibody tagged with a fluorescent dye, such as fluorescent or rhodamine. The number of cells that fluoresce is registered by passing those single cells through a laser light beam.

The total number of B cells can be counted by using fluorescein-labeled antibodies against all immunoglobulin classes. Specific monoclonal antibodies directed against T-cell marker allows the counting of T cells, CD4 helper cells, CD8 suppressor cells, and other cells. The ratio of CD4 to CD8 in normal person is 1.5 or more but becomes less than one in persons with AIDS.

**4. Rosette formation:** Rosette is a lymphocyte to which three or more sheep erythrocytes are attached. Most T cells form rosettes when mixed with sheep erythrocytes. T-cell rosette is

referred to as E-rosette. T cells can be determined by counting E-rosettes. Rosette formation is useful to detect T cells, hence the CMI of the host.

## Transfer Factor

Lawrence in 1954 first reported transfer of CMI in humans by injection of an extract from the leukocytes from the immunized host. The extract from leukocytes contained soluble substance known as *transfer factor (TF)*.

- The transferred immunity is specific in that CMI can be transferred only to those antigens to which the donor is specific.
- Transferred immunity is systemic and not local.
- TF does not transfer humoral immunity.

TF is a nucleopeptide with a low molecular weight of 2000–4000 Da. It is resistant to trypsin but gets inactivated by heating at 56°C for 30 minutes. It is nonantigenic. The exact mode of action of TF is not known. It is believed to stimulate the release of lymphokines from sensitized T lymphocytes.

### Key Points

TF has following clinical applications:

- It is used in treatment of disseminated infections associated with deficient CMI, such as tuberculosis and lepromatous leprosy.
- It is used in treatment of malignant melanoma and other types of cancer.
- It is used in treatment of Wiskott–Aldrich syndrome and other T-cell-deficient syndromes.

## Immunological Tolerance

Immunological tolerance is a state of specific immunologic unresponsiveness to a particular antigen to which a person has been exposed earlier. The immune tolerance prevents the body to mount immune response against the self-antigen.

### Mechanisms of Tolerance

Suggested mechanism of tolerance includes (a) clonal deletion, (b) clonal anergy, and (c) suppression.

- 1. Clonal deletion:** Clones of B and T lymphocytes that recognize self-antigens are selectively deleted in embryonic life, hence are not available to respond on subsequent exposure to antigen. This is known as clonal deletion.
- 2. Clonal anergy:** Clonal anergy means a condition in which clones of B and T lymphocytes that recognize self-antigens might be present but cannot be activated.
- 3. Suppression:** In this mechanism, clones of B and T lymphocytes expressing receptors that recognize self-antigens are

preserved. However, expression of immune responses following antigen recognition might be inhibited by active suppression.

## Types of Immune Tolerance

The immune tolerance may be of two types: natural or acquired.

**Natural tolerance:** Natural tolerance is nonresponsiveness to self-antigens. It develops during the embryonic life, and any antigen that comes in contact with the immune system during its embryonic life is recognized as self-antigen. The self-antigen would not induce any immune response. Burnet and Fenner (1949) also postulated that foreign antigens would not induce immune response if they were administered during the embryonic life.

**Acquired tolerance:** Acquired tolerance develops when a potential immunogen induces a state of unresponsiveness to itself. The antigen needs to be repeatedly or persistently administered to maintain the acquired tolerance. This is probably necessary because of the continuous production of new B and T cells that must be rendered tolerant. Induction of immune tolerance depends on a number of factors. These include (a) species and immune competence of the host and (b) physical nature, dose, and route of administration of antigens.

- **Species and immune competence of the host:** Tolerance depends on the immunological maturity of the host. Embryos and neonatal animals are immunologically immature, hence are more susceptible for induction of tolerance. Rabbits and mice can be made tolerant more rapidly than guinea pigs and chickens.
- **Physical nature, dose, and route of administration of antigens:** Soluble antigens and haptens can induce more immune tolerance than the aggregated antigens. For example, heat aggregated human gamma globulin is more tolerogenic than deaggregated gamma globulin in mice. It may possibly be due to enhanced phagocytosis of aggregated proteins than soluble antigens by macrophages, in which they can be presented to antibody-forming cells, thus inducing antibody synthesis. The induction of tolerance is dose dependent also. For example, a very simple molecule induces tolerance more readily than a complex one. Repeated minute doses as well as high doses of antigen induce B-cell tolerance, whereas a moderate degree of same antigen may be immunogenic. The route of administration is also important. In guinea pigs, intravenous or oral administration of certain haptens causes tolerance, whereas intradermal administration causes induction of immunity. T cells become tolerant more readily than B cells and also remain tolerant longer than B cells. Tolerance is overcome spontaneously or by injection of cross-reacting antigens. For example, in rabbits, tolerance to bovine serum albumin can be abolished by immunization with cross-reacting human serum albumin. Tolerance can be enhanced by administration of immunosuppressive drugs. For example, tolerance is enhanced in patients who have received organ transplants.

# Immunodeficiency

## Introduction

When a system errs by failing to protect the host from disease-causing agents or from malignant cells, the result is immunodeficiency. Immunodeficiency diseases and syndromes are the causes of significant mortality and morbidity, as well as a source of extremely valuable information about the physiology of the human immune system.

Immunodeficiency can occur in T cells, B cells, complement, and phagocytes—the major components of the immune system. A functional defect of the immune system is suspected when a patient:

- Has unusual frequency of infections with common or opportunistic microorganisms;
- Has unusually severe infections; and
- Is unable to eradicate infections with antibiotics to which the microorganisms are sensitive. Recurrent infections with certain viruses, protozoa, and fungi indicate a T-cell deficiency, whereas recurrent infections with pyogenic bacteria (such as staphylococci) indicate a B-cell deficiency.

Immunodeficiency disorders can be classified as (a) primary immunodeficiencies or (b) secondary immunodeficiencies.

## Primary Immunodeficiencies

A condition resulting from a genetic or developmental defect in the immune system is called a primary immunodeficiency. In such a condition, the defect is present at birth, although it may not manifest itself until later in life. Most of the primary immunodeficiencies are inherited from parents to offspring. Primary immunodeficiency may affect either adaptive or innate immune functions. Most defects that lead to immunodeficiencies affect either myeloid or lymphoid cell lineages. The lymphoid cell disorders may affect T cells, B cells, or both B and T cells, whereas the myeloid cell disorders may affect phagocytic function.

Primary immunodeficiency diseases can be classified as: (a) B-cell immunodeficiencies, (b) T-cell immunodeficiencies, (c) combined B-cell and T-cell deficiencies, (d) complement immunodeficiencies, and (e) phagocyte deficiencies.

## B-Cell Immunodeficiencies

B-cell deficiencies include (a) X-linked hypogammaglobulinemia, (b) selective immunoglobulin deficiencies, (c) hyper-IgM syndrome, and (d) interleukin-12 receptor deficiency.

## ► X-linked hypogammaglobulinemia

X-linked hypogammaglobulinemia, or infantile agammaglobulinemia or *X-linked agammaglobulinemia (XLA)*, is the prototype of “pure” B-cell deficiency. In the majority of cases, the disease is transmitted as a sex-linked trait. The defective gene is located on Xq21.2–22, the locus coding for the B-cell progenitor kinase or Bruton’s tyrosine kinase (Btk). Btk plays an important role in B-cell differentiation and maturation, and is also part of the group of tyrosine kinases involved in B-cell signaling in adult life. Most cases of infantile agammaglobulinemia are associated with mutations affecting Btk. X-linked hypogammaglobulinemia shows the following features:

- It is characterized by extremely low IgG levels and by the absence of other immunoglobulin classes.
- Individuals with XLA have no peripheral B cells and suffer from recurrent bacterial infections, beginning at about 9 months of age. Patients suffer from repeated infections caused by common pyogenic organisms (*Streptococcus pneumoniae*, *Neisseria meningitidis*, *Haemophilus influenzae*, *Staphylococcus aureus*, etc.) causing pyoderma, purulent conjunctivitis, pharyngitis, otitis media, sinusitis, bronchitis, pneumonia, empyema, purulent arthritis, meningitis, and septicemia. Chronic obstructive lung disease and bronchiectasis develop as a consequence of repeated bronchopulmonary infections. Infections with *Giardia lamblia* are diagnosed with increased frequency in these patients and may lead to chronic diarrhea and malabsorption.

Agammaglobulinemic patients are at risk of developing paralytic polio after vaccination with the attenuated virus; they also are at risk of developing chronic viral meningoencephalitis, usually caused by an echovirus. Arthritis of the large joints develops in about 30–35% of the cases and is believed to be infectious, caused by *Ureaplasma urealyticum*. This condition is best treated with replacement therapy using gamma globulin (a plasma fraction containing predominantly IgG, obtained from normal healthy donors) administered intravenously.

## ► Selective immunoglobulin deficiencies

In this condition, only one or more of the immunoglobulins are deficient in serum, while the others remain normal or elevated. IgA deficiency is the most common example of selective immunoglobulin deficiencies. IgA deficiency is characterized by nearly absent serum and secretory IgA. The IgA level is less than 5 ng/dL, but the remaining immunoglobulin class levels are normal or elevated. The disorder is either familial or it may

be acquired in association with measles or other types of viral infection, or toxoplasmosis.

The etiology of IgA deficiency is unknown, but is believed to be due to arrested B-cell development. The principal defect appears to be in IgA B-cell differentiation. The adult patients with selective IgA deficiency usually express the immature phenotype, only a few of which can transform into IgA-synthesizing plasma cells. Although IgA cells are produced, these cells fail to secrete IgA.

IgA is the principal immunoglobulin in secretions and is an important part of the defense of mucosal surfaces. Thus, IgA-deficient individuals have an increased incidence of respiratory, gastrointestinal, and urogenital infections. They also have an increased incidence of autoimmune diseases, such as systemic lupus erythematosus and rheumatoid arthritis. There is an increased incidence of the disorder in certain atopic individuals. Some selective IgA-deficiency patients form significant titers of antibody against IgA. They may develop anaphylactic reactions upon receiving IgA-containing blood transfusions.

Selective IgA deficiency is diagnosed by the demonstration of less than 5 mg/dL of IgA in serum. They, however, have normal levels of IgG and IgM antibodies. Some individuals develop antibodies against IgG, IgM, and IgA.

### ► Hyper-IgM syndrome

This condition is characterized by high concentration of serum IgM but very low concentration of serum IgG, IgA, and IgE. They have normal numbers of T cells and B cells. Some of these immunodeficiencies are X-linked and some are inherited as autosomal recessives. Patients with this condition are susceptible to recurrent microbial infections and many autoimmune disorders, such as thrombocytopenia, neutropenia, and hemolytic anemia.

### ► Interleukin-12 receptor deficiency

Patients with interleukin-12 receptor deficiency are highly susceptible to disseminated mycobacterial infections. Lack of interleukin-12 receptor prevents IL-12 initiating a Th-1 response, which is essential to prevent mycobacterial infections.

## T-Cell Immunodeficiencies

T-cell deficiencies include (a) DiGeorge syndrome, (b) chronic mucocutaneous candidiasis, (c) transient hypogammaglobulinemia of infancy, and (d) common, variable, unclassified immunodeficiency.

### ► Thymic aplasia (DiGeorge syndrome)

The DiGeorge syndrome or thymic aplasia is a classic example of a pure T-cell deficiency. Although the DiGeorge syndrome is a congenital immunodeficiency, it is not hereditarily transmitted. The condition is believed to be caused by an intrauterine infection prior to the eighth week of life, possibly of viral etiology. It is associated with microdeletions of chromosomal region 22q11. From the immunological point of view, it results due to defective embryogenesis of the third and fourth pharyngeal

clefts at 6–8 weeks of fetal life, leading to deficient development of the thymus and parathyroids.

Tetany and hypocalcemia, both characteristics of hypoparathyroidism, are observed in DiGeorge syndrome in addition to the defects in T-cell immunity. Peripheral lymphoid tissues exhibit a deficiency of lymphocytes in thymic-dependent areas. A defect in delayed-type hypersensitivity is demonstrated by the failure of affected patients to develop positive skin tests to commonly employed antigens, such as candidin or streptokinase and the inability to develop an allograft response. There is also minimal or absent *in vitro* responsiveness to T-cell antigens or mitogens. Defective cell-mediated immunity may increase susceptibility of the patient to opportunistic infections and render the individual vulnerable to a graft-versus-host reaction in blood transfusion recipients.

However, the B or bursa equivalent-dependent areas, such as lymphoid follicles, show normal numbers of B cells and plasma cells in patients with DiGeorge syndrome. Serum immunoglobulin levels are within normal limits, and there is a normal immune response following immunization with commonly employed immunogens. Considerable success in treatment of DiGeorge syndrome has been achieved with fetal thymic transplants and by the passive administration of thymic humoral factors.

### ► Chronic mucocutaneous candidiasis

Some patients with chronic infection of skin and mucosa with *Candida albicans* have exhibited a selective deficiency of cell-mediated immunity. Affected individuals develop severe and widespread forms of candidal infections. Skin tests with *Candida* antigens and *in vitro* lymphocyte proliferation responses to *C. albicans* reveal a selective lack of reactivity. T-lymphocyte functions are normal when tested with other antigens and mitogens. The humoral response to *C. albicans* is also normal. Symptomatic therapy with antimycotic agents is often unsuccessful.

### ► Transient hypogammaglobulinemia of infancy

This condition is characterized by the hypogammaglobulinemia in infants that occurs due to progressive catabolism of maternal IgG during the second and third months of life. This condition may persist until 2–3 years of age and become progressively more accentuated. In most cases, a deficiency of helper T-cell function appears to be responsible for the delay in immunoglobulin synthesis.

The diagnostic hallmark for this disease is low-for-age circulating immunoglobulin levels. Peripheral blood B lymphocytes are usually normal. Intravenous gamma globulin is indicated until the child's immunoglobulin levels normalize. With time, most children develop normal immune function.

### ► Common, variable, unclassified immunodeficiency

This condition, also known as *late onset hypogammaglobulinemia*, includes a large number of cases of primary immunodeficiency with heterogeneous presentations. These conditions



show a variable age of onset and patterns of inheritance, whose clinical picture is similar to that of XLA, but with a less severe course of clinical manifestations. T-cell function appears to be deficient in most cases, with abnormally low proliferative responses to T-cell mitogens.

Sinusitis and bacterial pneumonia are the predominant infections in patients with common, variable, unclassified immunodeficiency. Intestinal giardiasis is common. Opportunistic infections caused by *Pneumocystis jiroveci*, mycobacteria, viruses, and other fungi are also more frequent in these patients. Treatment usually involves administration of intravenous gamma globulin.

### Combined B-Cell and T-Cell Deficiencies

Combined B-cell and T-cell deficiencies include (a) severe combined immunodeficiency, (b) Wiskott–Aldrich syndrome, (c) ataxia telangiectasia, and (d) MHC class II deficiency.

#### ► Severe combined immunodeficiency

Severe combined immunodeficiency (SCID) includes many syndromes with severe deficiency of both humoral and cell-mediated immune responses. All these are inherited diseases with a defect in the differentiation of early stem cells. These are of two types: X-linked and autosomal.

**X-linked SCID:** The sex-linked SCID is associated with a defect of the gene that codes for a polypeptide chain common to several interleukin receptors (IL-2, IL-4, IL-7, IL-11, and IL-15). This chain is involved in signaling of second messages, thus in its absence, T-cell precursors fail to receive the signals necessary for their proliferation and differentiation. There is T- and B-cell lymphopenia and decreased production of IL-2. There is an absence of delayed-type hypersensitivity, cellular immunity, and of normal antibody synthesis following immunogenic challenge.

**Autosomal SCID:** This is due to a mutation in the gene encoding a tyrosine kinase called ZAP-70, which plays an important role in signal transduction in T cells. Other SCID patients show mutations in other genes, such as RAG-1 or RAG-2, that are essential to produce T-cell antigen receptor and the IgM monomer on the B cell that acts as antigen carrier.

SCID is a disease of infancy, presenting with failure to thrive. Affected individuals frequently die during the first 2 years of life. Clinically, they may develop a measles-like rash, show hyperpigmentation, and develop severe recurrent (especially pulmonary) infections. These patients have heightened susceptibility to *Pneumocystis carinii*, *C. albicans*, and other pathogens. Even attenuated microorganisms, such as those used for immunization, e.g., attenuated poliomyelitis viruses, may induce infection in SCID patients. All these forms of SCID can be corrected with a bone marrow graft from HLA-DR matched siblings. The graft is usually successful, but there is a great risk for the development of graft-versus-host disease.

**Graft-versus-host disease (GVHD):** It is a problem in SCID patients receiving unirradiated blood transfusions. It can also develop after transfusion of any fresh blood component

contaminated with viable T lymphocytes. It is characterized by fever, maculopapular rash involving the volar surfaces, diarrhea and protein-losing enteropathy, Coombs' positive hemolytic anemia, thrombocytopenia, and splenomegaly. In full-blown cases, the outcome is generally poor, with death occurring within 10–14 days from the onset of symptomatology. The reaction may be prevented in the case of transfusion by using frozen or irradiated blood products. Current attempts at eliminating all cells except stem cells from bone marrow grafts appear promising.

#### ► Wiskott–Aldrich syndrome

Wiskott–Aldrich syndrome is an X-linked recessive immunodeficiency disease of infants. It is characterized by thrombocytopenia, eczema, and increased IgA and IgE levels. There is decreased cell-mediated immunity. The inability to mount an IgM response to capsular polysaccharide of bacteria is the most important defect. IgA and IgE are increased, but IgM is diminished, although IgG serum concentrations are usually normal. By electron microscopy, T cells appear to lack the markedly fimbriated surface of normal T cells. T cells have abnormal sialophorin. The defect appears to be caused by the inability of T cells to provide help to B cells. Bone marrow transplantation corrects the deficiency.

#### ► Ataxia telangiectasia

It is an autosomal recessive disease caused by mutations in the gene that encodes DNA repair enzyme. This condition is characterized by ataxia, telangiectasia, and recurrent infections in babies by 2 years of age. IgA deficiency and lymphopenia commonly occur.

#### ► MHC class II deficiency

It is an autosomal recessive disease failing to express MHC molecules on the surface of antigen presenting cells, such as macrophages and B cells. This results in a deficiency of CD4 T cells. The lack of these helper T cells results in production of deficient antibodies.

### Complement Deficiencies

Complement deficiencies include the following conditions:

#### ► Recurrent infections

This is a condition caused by a deficiency of C1, C3, or C5, or even C6, C7, or C8 components of the complement. Patients with C3 deficiency are highly susceptible to infection with *S. aureus* and other pyogenic bacteria. Similarly, patients with C6, C7, or C8 deficiency are more susceptible to bacteremia with *N. meningitidis* or *Neisseria gonorrhoeae*.

#### ► Autoimmune diseases

Patients with deficiencies in C2 and C4 components have disease resembling systemic lupus erythematosus or other

autoimmune diseases. Patients with C2 deficiency are usually asymptomatic, and C2 deficiency is the most common complement defect.

### ▶ Paroxysmal nocturnal hemoglobinuria

It is a disease characterized by hemoglobinuria during night when patient is asleep. The hemoglobinuria occurs due to a complement-mediated hemolysis, especially at night. This is because the lower concentration of oxygen in the blood during sleep increases the susceptibility of the red blood cells to lysis. This occurs in the patients with a defect in the gene for the molecules that attach decay-accelerating factor (DAF) and other proteins to the cell membrane. This results in a deficiency of DAF on the surface of blood cell precursors, leading to an increased activation of complement and increased hemolysis.

### ▶ Hereditary angioedema

Hereditary angioedema is a disease caused by a deficiency of C1 inhibitor, a component of the complement. This deficiency results in the continual action of C1 on C4 to produce more C4a and subsequently more C3a and C5a complement components. An increased production of the vasoactive components, such as C3a and C5a, results in the production of capillary permeability and edema in larynx and several other organs. Steroids (such as oxymetholone and danazol) are used to treat the condition, because they increase the concentration of C1 inhibitors, thereby preventing increased production of more C3a and C5a.

## Phagocyte Deficiencies

Phagocyte deficiencies include (a) chronic granulomatous disease, (b) Chediak–Higashi syndrome, (c) Job's syndrome, (d) leukocyte adhesion deficiency, (e) myeloperoxidase deficiency, and (f) cyclic neutropenia.

### ▶ Chronic granulomatous disease

Chronic granulomatous disease (CGD) is a disorder that is inherited as an X-linked trait in two-thirds of the cases and as an autosomal recessive trait in the remaining one-third. Clinical manifestations are usually apparent before the end of the 2nd year of life. This is a condition associated with deficiency of an enzyme NADPH oxidase. This enzyme deficiency causes neutrophils and monocytes to have decreased consumption of oxygen and diminished glucose utilization by the hexose monophosphate shunt. Although neutrophils phagocytose microorganisms, they do not form superoxide and other oxygen intermediates that usually constitute the respiratory burst. All of these lead to decreased intracellular killing of bacteria and fungi. Thus, these individuals have an increased susceptibility to infection with microorganisms that normally are of relatively low virulence. These include *Aspergillus*, *Serratia marcescens*, and *Staphylococcus epidermidis*.

Patients with CGD may have hepatosplenomegaly, pneumonia, osteomyelitis, abscesses, and draining lymph nodes.

The quantitative nitroblue tetrazolium (NBT) test and the quantitative killing curve are both employed to confirm the diagnosis of CGD. Therapy includes interferon gamma, antibiotics, and surgical drainage of abscesses.

### ▶ Chediak–Higashi syndrome

It is a childhood disorder with an autosomal recessive mode of inheritance. The condition is identified by the presence of large lysosomal granules in leukocytes that are very stable and undergo slow degranulation. The large cytoplasmic granular inclusions that appear in white blood cells may also be observed in blood platelets and can be seen by regular light microscopy in peripheral blood smears. The condition is characterized by a defective neutrophil chemotaxis and an altered ability of the cells to kill ingested microorganisms. The majority of affected individuals die during childhood, although occasional cases may live longer.

There is no effective therapy other than the administration of antibiotics for treatment of the infecting microorganisms. High doses of ascorbic acid have been shown to restore normal chemotaxis, bactericidal activity, and degranulation.

### ▶ Job's syndrome

Job's syndrome is caused by failure of helper T cells to produce gamma interferon, which in turn reduces the ability of macrophages to kill bacteria. This results in an increased production of Th-2 and consequently an increased production of IgE. All these in turn cause more production of histamine that prevents certain components of inflammatory reaction and also inhibits chemotaxis. Therefore, the patient with this syndrome suffers repeatedly from staphylococcal abscesses as well as eczema with a high level of IgE.

### ▶ Leukocyte adhesion deficiency

It is an autosomal recessive disease caused by mutation in the gene encoding the B chain of an integrin that mediates adhesion of leukocytes to microbes. This causes poor adhesion of neutrophils to endothelial surfaces; hence phagocytosis of bacteria is inadequate.

### ▶ Cyclic neutropenia

It is an autosomal dominant disease in which there is a mutation in the gene encoding neutrophil esterase, an enzyme produced by neutrophils. The disease is characterized by a very low neutrophil count, less than 200/ $\mu$ L for 3–6 days of a 21-day cycle. The patients are susceptible to life-threatening bacterial infections during these 3–6 days of low neutrophil count but not when neutrophil counts are normal.

### ▶ Myeloperoxidase deficiency

It is a disease associated with deficiency of an enzyme myeloperoxidase, which is essential for the production of hypochlorite, a microbicidal agent. The deficiency of this enzyme is frequently seen but has little clinical importance. This is because other intracellular killing mechanisms of leukocytes are intact.

## Secondary Immunodeficiencies

Secondary immunodeficiencies occur secondary to numerous diseases or conditions, or as a consequence of therapeutic measures that depress the immune system. Most immunodeficient patients have secondary forms of immunodeficiency, caused by either pathological conditions that affect the immune system or the administration of therapeutic compounds with immunosuppressive effects. By far, the most common secondary immunodeficiency is acquired immunodeficiency syndrome (or AIDS), which results from infection with the human immunodeficiency virus (HIV).

Secondary immunodeficiencies are more common than primary immunodeficiencies and include AIDS, chemotherapy by immunosuppressive drugs (e.g., corticosteroids and nonsteroidal anti-inflammatory drugs), psychological depression, burns, radiation, Alzheimer’s disease, celiac disease, sarcoidosis, lymphoproliferative disease, Waldenstrom’s macroglobulinemia, multiple myeloma, aplastic anemia, sickle cell disease, malnutrition, aging, neoplasia, diabetes mellitus, and numerous other conditions. Secondary immunodeficiencies may be categorized as (a) B-cell deficiencies, (b) T-cell deficiencies, (c) complement deficiencies, and (d) phagocytic deficiencies as follows:

### B-Cell Deficiencies

#### ▶ Common variable hypogammaglobulinemia

This condition is caused due to a defective T-cell signaling resulting in failure to produce IgG in the body. This occurs in persons between the ages of 13 and 35 years. In this condition, the number of B cells is normal, but the ability to produce IgG and other immunoglobulins is greatly reduced. The cell-mediated immunity is normal. Patients with this condition are highly susceptible to infections caused by *S. pneumoniae*, *H. influenzae*, and other pyogenic bacteria. Administration of intravenous gamma globulin reduces the infections caused by these bacteria.

#### ▶ Malnutrition

In malnutrition, the synthesis of IgG is reduced due to low supply of amino acids. People with malnutrition, hence, are susceptible to infection by pyogenic bacteria.

### T-Cell Deficiencies

#### ▶ Acquired immunodeficiency syndrome (AIDS)

Patients with AIDS caused by HIV are highly susceptible to infection by many opportunistic pathogens including bacteria, viruses, fungi, and parasites. This is attributed to the loss of helper T-cell activity. The virus specifically infects and kills the cells bearing CD4 surface receptors. The immunity is highly suppressed, and failure of immune surveillance leads to a high incidence of tumors. For detail, refer Chapter 68.

#### ▶ Measles

T-cell function is altered, but immunoglobulins are normal in patients suffering from measles. Patients show a temporary suppression of delayed hypersensitivity.

### Complement Deficiencies

#### ▶ Liver failure

The synthesis of complement proteins is very much reduced in chronic hepatitis B or C and in liver failure caused by alcoholic cirrhosis. Hence, these patients are highly susceptible to infection by pyogenic bacteria.

#### ▶ Malnutrition

In severe malnutrition, the synthesis of complement proteins by liver is reduced due to low supply of amino acids. Therefore, people with malnutrition are susceptible to infection by pyogenic bacteria.

### Phagocyte Deficiencies

#### ▶ Neutropenia

The condition is characterized by a low neutrophil count (less than 500/ $\mu$ L), caused commonly by cytotoxic drugs, such as those used in cancer therapy. The patients are susceptible to severe bacterial infections caused by pyogenic bacteria, such as *S. aureus* and *S. pneumoniae*. Immunodeficiency diseases have been summarized in Table 18-1.

TABLE 18-1 Immunodeficiency syndromes

Disease	Specific deficiency	Molecular defect
<b>B-cell defects</b>		
X-linked agammaglobulinemia	Absence of B cells, very low IgG levels	Mutant tyrosine kinase
Selective IgA deficiency	Very low IgA levels	Failure of heavy-chain gene switching
Transient hypogammaglobulinemia of infants	Delay in initiation of IgG synthesis	
Common variable immunodeficiency	Total Ig is less, inability of B cells to differentiate	
Immunodeficiency with hyper-IgM	Low IgA and IgG, elevated IgM	
Transcobalamin II deficiency	Metabolic defects of vitamin B <sub>12</sub> deficiency	

(Continued)

TABLE 18-1

## Immunodeficiency syndromes (Continued)

Disease	Specific deficiency	Molecular defect
<b>T-cell defects</b>		
Thymic aplasia (DiGeorge syndrome)	Absence of T cells	Defective development of pharyngeal pouches
Chronic mucocutaneous candidiasis	Deficient T-cell response to <i>Candida</i>	Unknown
Purine nucleoside phosphorylase (PNP) deficiency	PNP deficiency	Autosomal recessive
<b>Both B- and T-cell defects</b>		
Nezelof syndrome	Deficient T-cell and B-cell immunity	
Ataxia telangiectasia	Lack of serum and secretory IgA, IgE	Autosomal recessive
Wiskott-Aldrich syndrome	Depressed cell-mediated immunity, serum IgM	X-linked disease
Severe combined immunodeficiency	Deficiency of both T cell and B cell	Defective IL-2 receptor, kinases, recombinases
Immunodeficiency with thymoma	Impaired cell-mediated immunity, thymic tumor, agammaglobulinemia	
<b>Complement disorders</b>		
Hereditary angioedema	Deficiency of C1 protease inhibitor	Excess C3a, C4a, and C5a generated
Complement component deficiencies	Insufficient C3, C6, C7, C8	Unknown
<b>Disorders of phagocytosis</b>		
Chronic granulomatous disease	Defective bactericidal activity	Deficient NADPH oxidase activity
Myeloperoxidase deficiency	Leukocytes have reduced myeloperoxidase	
Chediak-Higashi syndrome	Inclusions in leukocytes, diminished phagocytic activity	
Leukocyte G6PD deficiency	Deficient G6PD in leukocytes	

# Hypersensitivity

## Introduction

Hypersensitivity reaction denotes an immune response resulting in exaggerated or inappropriate reactions harmful to host. It is a harmful immune response in which tissue damage is induced by exaggerated or inappropriate immune responses in a sensitized individual on re-exposure to the same antigen. Both the humoral and cell-mediated arms of the immune response may participate in hypersensitivity reactions.

Hypersensitivity essentially has two components. First priming dose (first dose) of antigen is essential, which is required to prime the immune system, followed by a shocking dose (second dose) of the same antigen that results in the injurious consequences.

Depending on the time taken for the reactions and the mechanisms that cause the tissue damage, hypersensitivity has been broadly classified into immediate type and delayed type. In the former, the response is seen within minutes or hours after exposure to the antigen and in the latter, the process takes days together to manifest as symptoms.

Prince of Monaco first observed the deleterious effects of jellyfish on bathers. Subsequently, Portier and Richet (1906) suggested a toxin to be responsible for these effects and coined the term “anaphylaxis”.

Gell and Coombs (1963) classified hypersensitivity reactions into four categories based on the time elapsed from exposure of antigen to the reaction and the arm of immune system involved. Types I, II, and III are antibody-mediated and are known as **immediate hypersensitivity** reactions, while type IV is cell-mediated (i.e., mediated by cell-mediated immunity) and is known as **delayed hypersensitivity** reactions.

Type V hypersensitivity reaction has been described later. It is called stimulatory type reaction and is a modification of type II hypersensitivity reaction.

Differences between immediate and delayed hypersensitivities have been summarized in Table 19-1.

## Type I (Anaphylactic) Hypersensitivity

Type I hypersensitivity reaction is commonly called allergic or immediate hypersensitivity reaction. This reaction is always rapid, occurring within minutes of exposure to an antigen, and always involves IgE-mediated degranulation of basophils or mast cells.

Type I reactions are also known as IgE-mediated hypersensitivity reactions. IgE is responsible for sensitizing mast cells and

providing recognition of antigen for immediate hypersensitivity reactions. The short time lag between exposure to antigen and onset of clinical symptoms is due to the presence of pre-formed mediators in the mast cells. Thus, the time taken for these reactions to initiate is minimal, so the onset of symptoms seems to be immediate. Type I reaction can occur in two forms: anaphylaxis and atopy.

## Anaphylaxis

Anaphylaxis is an acute, potentially fatal, and systemic manifestation of immediate hypersensitivity reaction. It occurs when an antigen (**allergen**) binds to IgE on the surface of mast cells with the consequent release of several mediators of anaphylaxis. On exposure to the antigen, TH2 cells specific to the antigen are activated, leading to the stimulation of B cells to produce IgE antibody (Fig. 19-1). The IgE then binds to Fc portion of mast cells and basophils with high affinity. On re-exposure to the antigen, the allergen cross-links the bound IgE, followed by activation of IgE and degranulation of basophils and mast cells to release pharmacologically active mediators within minutes.

Binding of IgE to the mast cells is also known as sensitization, because IgE-coated mast cells are ready to be activated on repeat antigen encounter.

### ▶ Initiator cells in anaphylaxis

The initiator of type I reaction is otherwise known as *allergen*. Typical allergens include:

- Plant pollen, proteins (e.g., foreign serum and vaccines),
- Certain food items (e.g., eggs, milk, seafood, and nuts),
- Drugs (e.g., penicillin and local anesthetics),

TABLE 19-1

Differences between immediate and delayed hypersensitivities

Properties	Immediate	Delayed
Type	I, II, III	IV
Time to manifest	Minutes to hours	Days
Mediators	Antibodies	T cells
Route of sensitization	Any route	Intradermal
Passive transfer with serum	Possible	Not possible
Desensitization	Easy but short lived	Difficult but long lasting

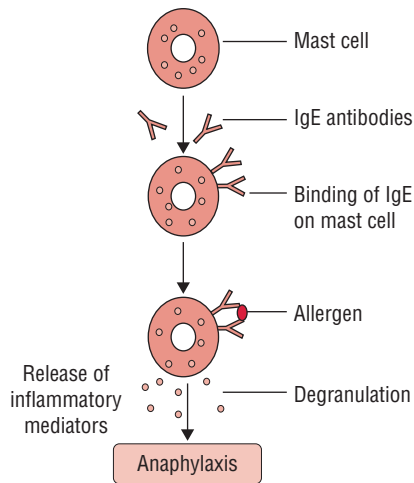

**FIG. 19-1.** A schematic diagram showing type I hypersensitivity reaction.

- Insect products (venom from bees, wasps, and ants),
- Dust mites, mould spores, and
- Animal hair and dander.

The exact reason for these substances to act as allergens is not known, although they show some common characteristics. Because these reactions are T-cell dependent, T-cell-independent antigens like polysaccharides cannot elicit type I reactions.

### ► Effector cells in anaphylaxis

The effector cells in anaphylaxis include (a) mast cells, (b) basophils, and (c) eosinophils. All these three cells contain cytoplasmic granules whose contents are the major mediators of allergic reactions. Also, all these three cell types produce lipid mediators and cytokines that induce inflammation.

**Mast cells:** Mast cells are the prime mediators of anaphylaxis. These cells are found throughout connective tissue, particularly near blood and lymphatic vessels. IgE-mediated degranulation of mast cells occurs when an allergen causes cross-linkage of the membrane-bound IgE. The importance of cross-linkage in the process can be understood by the fact that monovalent molecules, which cannot cause cross-linkage, are unable to cause degranulation.

### Key Points

Activation of mast cells results in three types of biologic responses:

- secretion of preformed contents of their granules by a regulated process of exocytosis;
- synthesis and secretion of lipid mediators; and
- synthesis and secretion of cytokines.

### ► Mediators of anaphylaxis

Many substances instead of a single substance are responsible for all manifestations of anaphylaxis. Important mediators include (a) histamine, (b) slow-reacting substances of anaphylaxis (SRS-A), (c) serotonin, (d) eosinophilic chemotactic factors of anaphylaxis, and (e) prostaglandins and thromboxanes.

**Histamine:** It is the most important mediator of anaphylaxis. It is found in a preformed state in granules of mast cells and basophils. It causes vasodilatation, increased capillary permeability, and smooth muscle contraction.

It is the principal mediator of allergic rhinitis (hay fever), urticaria, and angioedema. Antihistamines that block histamine receptors are relatively effective against allergic rhinitis but not against asthma.

**Slow-reacting substances of anaphylaxis:** These are produced by leukocytes. These consist of several leukotrienes, which do not occur in preformed state but are produced during reactions of anaphylaxis.

Leukotrienes are principal mediators of bronchoconstriction in asthma and are not inhibited by antihistamines. They cause increased vascular permeability and smooth muscle contraction.

**Serotonin:** Serotonin is found in preformed state in mast cells and platelets. It causes vasoconstriction, increased capillary permeability, and smooth muscle contraction.

**Eosinophilic chemotactic factors of anaphylaxis:** It is found in preformed state in granules of mast cells. It attracts eosinophils to the site of action. The role of eosinophils, however, is not clear in type I hypersensitivity reaction. Nevertheless, it is believed to reduce severity of type I hypersensitivity by releasing the enzymes histaminase and arylsulfatase that degrade histamine and SRS-A, respectively.

**Prostaglandins and thromboxanes:** Prostaglandins cause bronchoconstriction as well as dilatation and increased permeability of capillaries. Thromboxanes cause aggregation of platelets.

All these mediators are inactivated by enzymatic reactions very rapidly, hence are active only for a few minutes after their release.

### ► Phases of anaphylaxis

The spectrum of changes seen in type I hypersensitivity can be considered under immediate and late phases.

**Immediate phase:** This phase is characterized by degranulation and release of pharmacologically active mediators within minutes of re-exposure to the same antigen.

Histamine is the principal biogenic amine that causes rapid vascular and smooth muscle reactions, such as vascular leakage, vasodilatation, and bronchoconstriction. It is responsible for the “wheal and flare” response seen in cutaneous anaphylaxis and also for the increased peristalsis and bronchospasm associated with ingested allergens and asthma, respectively.

Other lipid mediators, such as prostaglandins (PGD<sub>2</sub>) and leukotrienes (LTC<sub>4</sub>)—which are derived from arachidonic acid by the cyclooxygenase pathway and lipoxygenase pathway, respectively, also cause similar reactions. Prostaglandins and leukotrienes promote bronchoconstriction, neutrophil chemotaxis, and aggregation at inflammatory sites.

**Late phase:** This phase begins to develop 4–6 hours after the immediate phase reaction and persists for 1–2 days. It is characterized by the infiltration of neutrophils, macrophages,

eosinophils, and lymphocytes to the site of reaction. This leads to an amplification of the various inflammatory symptoms seen as a part of the early reaction like bronchoconstriction and vasodilatation. The cells remain viable after degranulation and proceed to synthesize other substances that are released at a later time, causing the late phase of type I reactions. The mediators are not detectable until after some hours of the immediate reaction. The important mediators involved during the late phase are:

- slow-reacting substances of anaphylaxis (SRS-A) that contain several leukotrienes (e.g., LTC<sub>4</sub>, LTD<sub>4</sub>, and LTE<sub>4</sub>);
- platelet-aggregating factor; and
- cytokines released from the mast cells.

### ► Clinical manifestations of anaphylaxis

Anaphylaxis is an acute, life-threatening reaction usually affecting multiple organs. The time of onset of symptoms depends on the level of hypersensitivity and the amount, diffusibility, and site of exposure to the antigen.

Multiple organ systems are usually affected, including the skin (pruritus, flushing, urticaria, and angioedema), respiratory tract (bronchospasm and laryngeal edema), and cardiovascular system (hypotension and cardiac arrhythmias). When death occurs, it is usually due to laryngeal edema, intractable bronchospasm, hypotensive shock, or cardiac arrhythmias developing within the first 2 hours (Table 19.2).

**Anaphylactoid reaction:** This appears to be clinically similar to anaphylactic reaction but differs from it in many ways. First, it is not IgE mediated. Second, the inciting agents (such as drugs or iodinated contrast media) stimulate directly basophils and mast cells to release mediators without any involvement of the IgE.

### ► Management and prevention of anaphylaxis

Desensitization is an effective way for prevention of systemic anaphylaxis. It is of two types: acute desensitization and chronic desensitization.

**Acute desensitization** involves the administration of small amounts of antigen to which the person is sensitive, at an interval of 15 minutes. The complex of antigen-IgE is produced in

small quantities; hence enough mediators are not released to produce a major reaction. However, this action is short lived because of the return of hypersensitivity reaction due to continued production of IgE.

**Chronic desensitization** involves the long-term administration of antigen to which the person is sensitive, at an interval of weeks. This stimulates the production of IgA- and IgG-blocking antibodies that prevent subsequent antigen to binding to mast cells, therefore, preventing the reaction.

Administration of drugs to inhibit the action of mediators, maintenance of airways, and support of respiratory and cardiac functions form the mainstay of treatment of anaphylactic reactions.

### Atopy

The term *atopy* was first coined by Coca (1923) to denote a condition of familial hypersensitivities that occur spontaneously in humans. Atopy is recurrent, nonfatal, and local manifestation of immediate hypersensitivity reaction.

The reaction shows a high degree of familial predisposition and is associated with a high level of IgE. It is localized to a specific tissue, often involving epithelial surfaces at the site of antigen entry. It is mediated by IgE antibodies, which are homocytotropic (i.e., species specific). Only human IgE can fix to surface of mast cells.

Common manifestations of atopy are asthma, rhinitis, urticaria, and atopic dermatitis. The commonest of atopic reactions is bronchial asthma.

Atopy is associated with mutations in certain genes encoding the alpha chain of the IL-4 receptor. These mutations facilitate the effectiveness of IL-4, resulting in an increased production of IgE synthesis by B cells.

Atopic individuals produce high levels of IgE in response to allergens as against the normal individuals who do not. This depends on the propensity of an individual to mount a TH<sub>2</sub> response, because it is only TH<sub>2</sub> cell-derived cytokines that stimulates the heavy-chain isotype switching to the IgE class in B cells. Stimulation of heavy chain isotype switching to the IgE class may be influenced by a variety of factors including inherited genes, the nature of the antigens, and the history of antigen exposure.

TABLE 19-2

Mechanism and manifestations of hypersensitivity reactions

Type	Syndromes caused	Mechanism
Type I	Hay fever, asthma, hives, and eczema	IgE mediated
Type II	Blood transfusion reactions, erythroblastosis fetalis, and autoimmune hemolytic anemias	Antibodies against cell surface antigen, causing damage by ADCC or complement activation
Type III	Arthus reaction, Farmer's lung, Serum sickness, rheumatoid arthritis, necrotizing vasculitis, glomerulonephritis, SLE, immune complex in hepatitis B, and malaria	Mediated by immune complexes containing complement-fixing antibodies
Type IV	Contact dermatitis, tubercular lesions, and graft rejection	T <sub>H</sub> cells cause the release of cytokines which stimulate macrophages or cytotoxic T cells to mediate direct cellular damage

Atopic hypersensitivity is non-transferable by lymphoid cells, but by serum. This observation was used in the past for diagnosis of passive cutaneous anaphylaxis reaction by Prausnitz–Kustner reaction.

## Key Points

**Prausnitz–Kustner reaction:** This is based on the special affinity of IgE antibody for cells of the skin. In this experiment, serum was collected from Kustner who suffered from gastrointestinal allergy to certain cooked fish. The same serum was given intradermally to Prausnitz, who was then given another intradermal injection of small quantity of cooked fish into the same site, 24 hours later. This resulted in a wheal and flare at the site of injection within minutes. The test, however, is not done nowadays due to risk of transmission of certain blood-borne viral infections, such as hepatitis B, hepatitis C, and HIV.

Radioallergosorbent test (RAST), enzyme linked immunosorbent assay (ELISA), and passive agglutination tests are the frequently used tests for detection of IgE in the serum for diagnosis of atopy.

## Type II (Cytotoxic) Hypersensitivity

Type II cytotoxic reaction is mediated by antibodies directed against antigens on the cell membrane that activates complement thereby causing antibody-mediated destruction of cells (Fig. 19-2). The cell membrane is damaged by a membrane attack complex during activation of the complement.

The reactions involve combination of IgG or IgM antibodies with the cell-fixed antigens or alternately circulating antigens absorbed onto cells. Antigen–antibody reaction leads to complement activation, resulting in the formation of membrane attack complex. This complex then acts on the cells, causing damage to the cells, as seen in complement-mediated lysis in Rh hemolytic disease, transfusion reaction, or hemolytic anemia. Similarly, the antibodies combining with tissue antigens

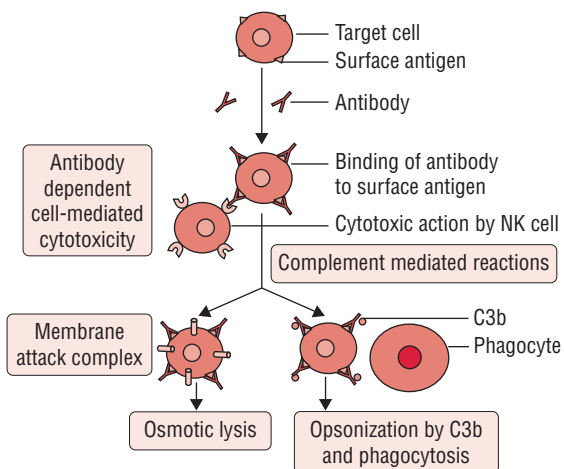

**FIG. 19-2.** A schematic diagram showing type II hypersensitivity reaction.

contribute to the pathogenesis of Goodpasture’s syndrome, pemphigus, and myasthenia gravis.

**Antibody-dependent cell-mediated cytotoxicity (ADCC):** It is another mechanism, which involves the binding of cytotoxic cells with Fc receptors in the Fc binding part of the antibodies coating the target cells. The antibody coating the target cell can also cause its destruction by acting as an opsonin. This mechanism is important in immunity against large-sized pathogens, such as the helminths.

## Transfusion Reactions

A large number of proteins and glycoproteins are present on the surface of RBCs, of which A, B, and O antigens are of particular importance. Antibodies to these antigens are called isohemagglutinins and are of IgM class. When transfusion with mismatched blood occurs, a transfusion reaction takes place due to the destruction of the donor RBCs through the isohemagglutinins against the foreign antigen.

The clinical manifestations result from the massive intravascular hemolysis of the donor cells by antibody and complement.

## Erythroblastosis Fetalis

This condition develops when maternal antibodies specific for fetal blood group antigens cross the placenta and destroy fetal RBCs. This condition is seen in cases where a presensitized Rh-negative mother mounts an immune response against Rh-positive RBCs of the fetus. This results in severe hemolysis, leading to anemia and hyperbilirubinemia, which can even be fatal.

## Drug-Induced Hemolysis

Certain drugs (such as penicillin, quinidine, phenacetin, etc.) may induce hemolysis of red blood cells. They attach to the surface of red blood cells and induce formation of IgG antibodies. These autoantibodies then react with red blood cell surface, causing hemolysis. Similarly, quinacrine attaches to surface of platelets and induce autoantibodies that lyse the platelets, causing thrombocytopenia.

## Goodpasture’s Syndrome

Autoantibodies of IgG class are produced against basement membrane of the lungs and kidneys in Goodpasture’s syndrome. Such autoantibodies bind to tissues of the lungs and kidneys and activate the complement that leads to an increased production of C5a, a component of the complement. The C5a causes attraction of leukocytes, which produce enzyme proteases that act on lung and kidney tissues, causing damage of those tissues.

## Rheumatic Fever

In this condition, antibodies are produced against group A streptococci that cross-react with cardiac tissues and activate complement and release of components of complement, which in turn causes damage of cardiac tissues.



## Type III (Immune-Complex) Hypersensitivity

Type III reaction is mediated by antigen-antibody immune complexes, which induce an inflammatory reaction in tissues.

### Mechanism of Immune-Complex Hypersensitivity

In many situations, reactions between the various antigens and antibodies in the body give rise to formation of immune complexes (Fig. 19-3). In the normal course, these immune complexes are normally removed by mononuclear-phagocyte system through participation of RBC. However, the body may be exposed to an excess of antigen in many conditions, such as persistent infection with a microbial organism, autoimmunity to self-components, and repeated contact with environmental agents. When the clearance capacity of this system is exceeded, deposition of the complexes takes place in various tissues.

Immune complexes are deposited (a) on blood vessel walls, (b) in the synovial membrane of joints, (c) on the glomerular basement membrane of the kidneys, and (d) on the choroid plexus of the brain. Sometimes, immune complexes are formed at the site of inflammation itself. These *in situ* immune complexes, in certain cases, may be beyond the reach of phagocytic clearance and hence aggregate and cause disease.

Immune complexes fix complement and are potent activators of the complement system. Activation of the complement results in the formation of complement components, such as C3a- and C5a-anaphylatoxins that stimulate release of vasoactive amines. The C5a attracts neutrophils to the site, but these neutrophils fail to phagocytose large aggregated mass of immune complexes, and instead release lysosomal enzymes and lytic substances that damage host tissue.

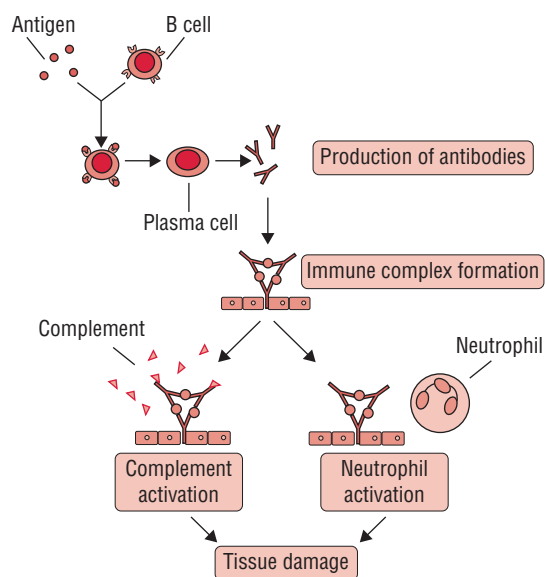

FIG. 19-3. A schematic diagram showing type III hypersensitivity reaction.

The proteolytic enzymes (including neutral proteinases and collagenase), kinin-forming enzymes, polycationic proteins, and reactive oxygen and nitrogen intermediates cause damage in the local tissues and enhance the inflammatory responses. Platelets aggregated by intravascular complexes provide yet another source of vasoactive amines and may also form microthrombi, which can lead to local ischemia.

### Manifestations of Immune-Complex Hypersensitivity

Arthus reactions and serum sickness reactions are two typical manifestations of type III hypersensitivity.

#### Arthus reactions

Arthus reaction is an inflammatory reaction caused by deposition of immune complexes at a localized site. This reaction is named after Dr. Arthus who first described this reaction. This reaction is edematous in the early stages, but later can become hemorrhagic and, eventually, necrotic.

The lag time between antigen challenge and the reaction is usually 6 hours. This is considerably longer than the lag time of an immediate hypersensitivity reaction, but shorter than that of a delayed hypersensitivity reaction. Tissue damage is caused by deposition of antigen-antibody immune complexes and complement. The activation of complement through its product of activation causes vascular occlusion and necrosis.

#### Key Points

- Hypersensitivity pneumonitis is the clinical manifestation of Arthus reaction. Farmer's lung, cheese-washer's lung, wood-worker's lung, and wheat-miller's lung are the examples of hypersensitivity pneumonitis associated with different occupations. All these conditions are caused by inhalation of fungi or bacteria present in different products handled by the infected people.
- Arthus reaction can also occur locally at the site of tetanus immunization, if toxoids are given at the same site within a very short period of 5 years.

#### Serum sickness

Serum sickness is a systemic inflammatory reaction caused by deposition of immune complexes at many sites of the body. The condition manifests after a single injection of a high concentration of foreign serum. It appears a few days to 2 weeks after injection of foreign serum or certain drugs, such as penicillin. However, serum sickness is considered as an immediate hypersensitivity reaction, because symptoms appear immediately after formation of immune complex.

Unlike type I hypersensitivity reaction, a single injection acts as both priming and shocking doses. Fever, lymphadenopathy, rashes, arthritis, splenomegaly, and eosinophilia are the typical manifestations. Disease is self-limited and clears without sequelae.

## Immune-Complex Diseases

Formation of circulating immune complexes contributes to the pathogenesis of a number of conditions other than serum sickness. These include the following:

1. Autoimmune diseases
  - Systemic lupus erythematosus (SLE)
  - Rheumatoid arthritis
2. Drug reactions
  - Allergies to penicillin and sulfonamides
3. Infectious diseases
  - Poststreptococcal glomerulonephritis
  - Meningitis
  - Hepatitis
  - Infectious mononucleosis
  - Malaria
  - Trypanosomiasis

## Type IV Delayed (Cell-Mediated) Hypersensitivity

Type IV hypersensitivity reaction is called delayed type hypersensitivity (DTH), because the response is delayed. It starts hours or days after primary contact with the antigen and often lasts for days. The reaction is characterized by large influxes of nonspecific inflammatory cells, in particular, macrophages. It differs from the other types of hypersensitivity by being mediated through cell-mediated immunity. This reaction occurs due to the activation of specifically sensitized T lymphocytes rather than the antibodies.

Initially described by Robert Koch in tuberculosis as a localized reaction, this form of hypersensitivity was known as tuberculin reaction. Later, on realization that the reaction can be elicited in various pathologic conditions, it was renamed as delayed type hypersensitivity.

### Mechanism of DTH

The DTH response begins with an initial sensitization phase of 1–2 weeks after primary contact with an antigen (Fig. 19-4):

- TH1 subtypes CD4 are the cells activated during the sensitization phase.
- A variety of antigen-presenting cells (APCs) including Langerhans cells and macrophages have been shown to be involved in the activation of a DTH response. These cells are believed to pick up the antigen that enters through the skin and transport it to regional lymph nodes, where T cells are activated by the antigen.
- The APCs present antigens complexed in the groove of major histocompatibility complex (MHC) molecules expressed on the cell surface of the APCs.
- For most protein antigens or haptens associated with skin DTH, CD4<sup>+</sup> T cells are presented with antigens bound to

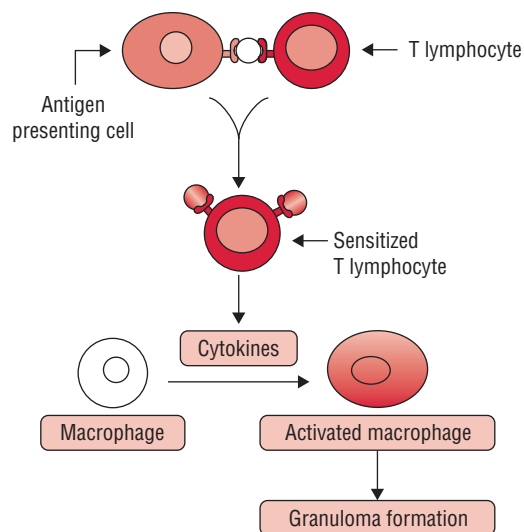

**FIG. 19-4.** A schematic diagram showing type IV hypersensitivity reaction.

MHC class II alleles, human leukocyte antigen (HLA)-DR, HLA-DP, and HLA-DQ. Specific MHC class II alleles are recognized to produce excessive immune activation to antigens.

- On subsequent exposure, the effector phase is stimulated. The TH1 cells are responsible in secreting a variety of cytokines that recruit and activate macrophages and other nonspecific inflammatory cells.
- The response is marked only after 2–3 days of the second exposure. Generally, the pathogen is cleared rapidly with little tissue damage. However, in some cases, especially if the antigen is not easily cleared, a prolonged DTH response can itself become destructive to the host, as the intense inflammatory response develops into a visible granulomatous reaction.

### Types of DTH Reactions

DTH reactions are of two types: contact hypersensitivity and tuberculin-type hypersensitivity reactions.

#### ► Contact hypersensitivity

Contact hypersensitivity is a manifestation of DTH occurring after sensitization with certain substances. These include drugs, such as sulfonamides and neomycin; plant products, such as poison ivy and poison oak; chemicals, such as formaldehyde and nickel; and cosmetics, soaps and other substances.

This reaction manifests when these substances acting as haptens enter the skin and combine with body proteins to become complete antigens to which a person becomes sensitized. On second exposure to the same antigen, the immune system responds by attack of cytotoxic T cells that cause damage, mostly in the skin.

The condition manifests as itching, erythema, vesicle, eczema, or necrosis of skin within 12–48 hours of the second exposure.

### ▶ Tuberculin-type hypersensitivity reaction

Tuberculin reaction is a typical example of delayed hypersensitivity to antigens of microorganisms, which is being used for diagnosis of the disease.

**Tuberculin skin test:** This test is carried out to determine whether an individual has been exposed previously to *Mycobacterium tuberculosis* or not. In this test, a small amount of tuberculin (PPD), a protein derived from the cell wall of *M. tuberculosis*, is injected intradermally. Development of a red, slightly swollen, firm lesion at the site of injection after 48–72 hours indicates a positive test. A positive test indicates that the person has been infected with the bacteria but does not confirm the presence of the disease, tuberculosis. However, if a person with a tuberculin-negative skin test becomes positive, then it indicates that the patient has been recently infected. The skin test, however, can even become negative in:

- Infected persons receiving therapy with immunosuppressive drugs (such as corticosteroids and anticancer drugs) and
- In those suffering from the diseases associated with suppressed cell-mediated immunity (such as AIDS, sarcoidosis, lymphoma, post measles vaccination, etc.).

The response to *M. tuberculosis* illustrates that while on one hand mechanisms involved in DTH are required for defense against the organism; on the other hand, these are also responsible for tissue damage in the longer run. Cytokines (like TNF and IFN- $\gamma$ ), which have been produced to activate the macrophages and thus contain the infection, also trigger other cascades that lead finally to extensive tissue damage.

Various other skin tests are used to detect DTH. These include many skin tests in bacterial, fungal, viral, and helminthic infections.

Lepromin test is a useful test for leprosy. A positive lepromin test indicates the presence of tuberculoid leprosy with intact

Characteristics	Contact hypersensitivity	Tuberculin-type hypersensitivity
Site	Epidermal	Intradermal
Antigen	Organic chemicals, poison ivy, metals, etc.	Tuberculin, lepromin, leishmanin skin tests, etc.
Reaction time	48–72 hours	48–72 hours

cell-mediated immunity. On the other hand, a negative lepromin test indicates the presence of lepromatous leprosy with impaired cell-mediated immunity.

Positive skin tests in coccidioidomycosis, paracoccidioidomycosis and other fungal infections suggest exposure to the fungi. In both viral and parasitic infections, skin tests are less specific and less useful than the serological tests for diagnosis.

Differences between contact hypersensitivity and tuberculin-type hypersensitivity reaction are summarized in Table 19-3.

### Type V (Stimulatory Type) Hypersensitivity

In this type of hypersensitivity reaction, antibodies combine with antigens on cell surface, which induces cells to proliferate and differentiate and enhances activity of effector cells. Type V hypersensitivity reaction plays an important role in pathogenesis of Graves' disease, in which thyroid hormones are produced in excess quantity. It is postulated that long-acting thyroid-stimulating antibody, which is an autoantibody to thyroid membrane antigen, combines with thyroid-stimulating hormone (TSH) receptors on a thyroid cell surface. Interaction with TSH receptor produces an effect similar to the TSH, resulting in an excess production and secretion of thyroid hormone, which is responsible for Graves' disease.

Table 19-4 summarizes important features of various types of hypersensitivity.

	Type I	Type II	Type III	Type IV
Antigen	Exogenous	Cell surface	Soluble	Tissue and organ
Antibody	IgE	IgG, IgM	IgG, IgM	None
Reaction time	15–30 minutes	Minutes to hours	3–8 hours	48–72 hours
Transfer	Antibody	Antibody	Antibody	T cells
Conditions	Hay fever, allergy, and asthma	Erythroblastosis fetalis and Goodpasture's syndrome	SLE, serum sickness	Tuberculin test, poison ivy, etc.

# Autoimmunity

## Introduction

The immune system is a finely tuned system, which functions round-the-clock whole life to protect the body against various foreign cells, be it microbes or abnormal cells. Though the immune system is up and running all the time surrounded by self-antigens, it does not mount a response against them. At times, these mechanisms go awry, and this results in injury to various tissues.

Autoimmunity is a condition when the body produces auto-antibodies and immunologically competent T lymphocytes against its own tissues. Conditions where the mechanisms of self-tolerance fail are termed as autoimmune disorders and the phenomenon is called autoimmunity.

Autoimmunity literally means “protection against self”; however, in practice it leads to “injury to self.” At the clinical level, autoimmunity is apparently involved in a variety of apparently unrelated diseases, such as systemic lupus erythematosus (SLE), insulin-dependent diabetes mellitus, myasthenia gravis, rheumatoid arthritis, multiple sclerosis, and hemolytic anemias.

Ehrlich in 1901 first postulated the existence of tolerance to self-antigens as also those situations where this mechanism would fail, leading to “*horror autotoxicus*”. More recently, an understanding of the various immunological mechanisms and disorders has led to the same conclusions.

## Tolerance

Tolerance is a state of specific immunological unresponsiveness to a certain antigen or epitope, although the immune system is otherwise functioning normally. The antigens that are present during embryonic life are usually considered self and do not stimulate an immunologic response, hence the host remains tolerant to those antigens. The absence of an immune response in the fetus is due to the deletion of self-reactive T-cell precursors in the thymus. On the other hand, the antigens that are not present during the process of maturation are considered nonself and usually elicit an immunologic response against those antigens.

## Mechanisms of Tolerance

Both T cells and B cells participate in tolerance, but it is T-cell tolerance that plays a major role.

## ► T-cell tolerance

T-cell tolerance is explained by theories of (a) clonal deletion, (b) clonal anergy, and (c) clonal ignorance.

**1. Clonal deletion:** The theory of clonal deletion described by Burnet, Fenner, and Medawar based on their studies on mice was the first theory of tolerance. The recent studies suggest that T lymphocytes acquire the ability to distinguish self from nonself by the process of clonal deletion during the early phases of life. This process involves the killing of T cells (*negative selection*) that acts against antigens, mainly self-MHC (major histocompatibility complex) molecules present in the fetus during that time. The self-reactive cells die by apoptosis, a process of programmed cell death.

**2. Clonal anergy:** Clonal anergy is a process that leads to the incapacitation of the self-reactive T cells. These cells become incapable of mounting an immune response due to lack of proper costimulation and are called as anergic.

**3. Clonal ignorance:** This is the term used to describe self-reactive T cells that ignore self-antigens. These self-reactive T cells ignore self-antigens because the antigens are present in very small quantities. Also, these self-reactive cells are kept ignorant by physical separation from the target antigens, such as blood-brain barrier.

## ► B-cell tolerance

B cells become tolerant to self-antigens also by (a) clonal deletion of B-cell precursors while they are in the bone marrow and (b) clonal anergy of B cells in the periphery.

## Pathogenesis of Autoimmunity

### Mechanisms

The following mechanisms have been proposed for pathogenesis of autoimmunity:

1. Release of sequestered antigens
2. Antigen alteration
3. Epitope spreading
4. Molecular mimicry

► **Release of sequestered antigens**

Certain tissues, such as sperm, central nervous system, and the lens and uveal system of the eye, are sequestered or hidden. These sites are normally never exposed to the immune system for various reasons. These are called immunologically privileged sites. When these hidden or sequestered antigens are released, exposed to as a result of injury, the host immune system—both cellular and humoral—does not consider them as self but as foreign, and hence attacks them. For example, lens protein is enclosed within its capsule and has no contact with circulation. Therefore, immunological tolerance against lens protein is not developed during fetal life. Following injury or cataract surgery, when this antigen is leaked into circulation, it elicits an immune response, which results in damage to the lens of other eye.

Similarly, developing sperms are found within the lumen of the testicular tubules, which are sealed off early in embryonic development, prior to the development of the immune system. These developing sperms are enclosed within a sheath of tightly joined Sertoli cells, hence are never accessed to immune cells. If these are exposed by surgery or vasectomy and injury, an immune response occurs against the sperm, producing aspermatogenesis that may lead to male sterility.

DNA, histones, and mitochondrial enzymes are the intracellular antigens that are normally sequestered from the immune system. However, certain viral or bacterial infections and exposure to radiation and chemicals can damage these cells and release sequestered intracellular antigens into circulation. These antigens then elicit a strong immune response. The autoantibodies are produced against these antigens, which combine with subsequently released sequestered antigens. This results in the formation of immune complexes, which causes damage to tissues. For example, following an infection by mumps, the virus causes damage to the basement membrane of seminiferous tubules, thereby eliciting an immune response and resulting in orchitis.

► **Antigen alteration**

Certain physical, chemical, or biological factors may alter tissue antigens, resulting in formation of new cell surface antigens called *neoantigens*. These neoantigens are no longer recognized as self, therefore, appear foreign to immune system, thereby eliciting an immune response. Procainamide-induced SLE is an example of an autoimmune disease caused by this mechanism.

► **Epitope spreading**

Epitope spreading is the term used to describe the new exposure of sequestered autoantigens as a result of damage to cells caused by viral infections. It is another process that is believed to contribute to pathogenesis of autoimmunity. These newly exposed autoantigens or epitopes stimulate autoreactive

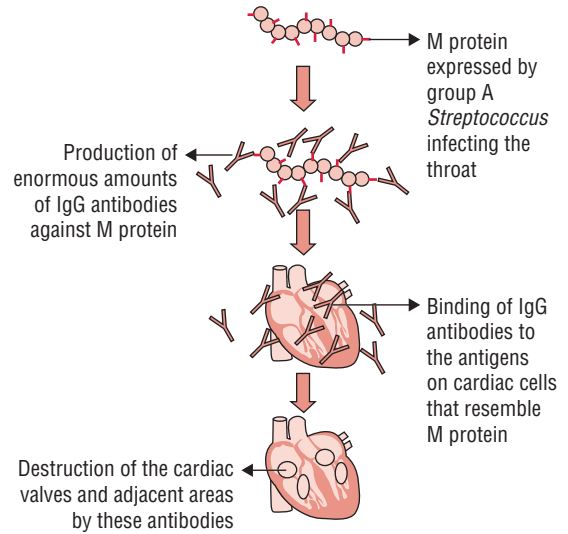

**FIG. 20-1.** Pathogenesis of acute rheumatic fever.

T cells, resulting in autoimmune diseases. For example, in experimental animal infection, a multiple sclerosis-like disease is caused by an infection with an encephalomyelitis virus. In this condition, the self-reactive T cells are directed against cellular antigens but not against the virus that cause the sclerosis-like disease.

► **Molecular mimicry**

Molecular mimicry is a process in which infection by particular microbial pathogen is associated with the subsequent development of specific autoimmune diseases.

**Key Points**

- Sharing of M protein of *Streptococcus pyogenes* and myosin of cardiac muscle is one of many examples of molecular mimicry. Repeated infections with *S. pyogenes* induce the production of antibodies against certain M proteins that cross-react with myosin of cardiac muscle, resulting in damage to cardiac tissue, leading to rheumatic fever (Fig. 20-1).
- Similarly, infection with *Shigella* spp. or *Chlamydia* spp. may result in Reiter’s syndrome and infection with *Campylobacter* spp. may lead to Guillain-Barre syndrome.
- Development of encephalitis in certain cases following vaccination with rabies Semple vaccine is due to molecular mimicry of sheep brain antigens, used in the vaccine, with that of neural tissues in the brain.

**Autoimmune Pathological Process**

The autoimmune pathological process may be initiated and maintained by (a) autoantibodies, (b) immune complexes containing autoantigens, and (c) autoreactive T lymphocytes. Each of these immune processes plays a major role in certain diseases or may be synergistically associated, particularly in multiorgan, systemic autoimmune diseases.

**1. Autoantibodies:** Autoantibody associated diseases are characterized by the presence of autoantibodies in the individual's serum and by the deposition of autoantibodies in tissues. Autoantibodies may be directly involved in the pathogenesis of certain diseases, while in others they may serve simply as disease markers without a known pathogenic role. They may also be instrumental in triggering various pathogenic mechanisms leading to tissue injury and cell death. Autoantibodies play a key role in the pathogenesis of (a) myasthenia gravis, (b) pemphigus vulgaris, and (c) various autoimmune cytopenias.

**2. Immune complexes containing autoantigens:** The formation of immune complexes between self-antigens and autoantibodies, leading to end organ damage, is another pathogenic mechanism seen in autoimmune disorders. Only those immune complexes that are of adequate size manage to activate the complement system and are involved in the pathogenesis of autoimmune diseases. Systemic lupus erythematosus and polyarteritis nodosa are two classic examples of autoimmune diseases in which immune complexes play a major pathogenic role.

**3. Autoreactive T lymphocytes:** Antigens that are sequestered from the circulation, and are therefore not seen by the developing T cells in the thymus, do not induce self-tolerance. Exposure of mature T cells to such normally sequestered antigens at a later time might result in their activation. Induction of autoantibodies to sperms after vasectomy, sympathetic ophthalmitis, and the presence of antibodies to myocardial cells after myocardial infarction are the examples.

Inappropriate expression of class II MHC molecules can also sensitize self-reactive T cells in certain other situations. This is supported by the clinical observations showing increased frequency of autoimmune diseases in families and by increased rates of clinical concordance in monozygotic twins. Polyclonal B-cell activation may also lead to initiation of autoimmune disease process.

## Animal Models of Autoimmunity

Better understanding of autoimmune disease has been facilitated by many experimental studies in animal models. Several animal models have been developed, each sharing some characteristics of a human disease of autoimmune etiology. These animal models often provide only the experimental approaches to the study of pathogenesis of autoimmune diseases. In some animal models, autoimmune diseases are induced by injecting normal animals with antigens extracted from the human target tissues, resulting in an autoimmune disease with a rapid onset and an acute course.

The usual models used are mice and rats. Experimentally induced autoimmune diseases in these animals include (a) myasthenia gravis, (b) multiple sclerosis, (c) rheumatoid arthritis, and (d) Hashimoto's thyroiditis.

## Autoimmune Diseases

Different molecules, cells, and tissues are affected in autoimmune diseases. Table 20-1 summarizes affected tissue, target

antigens, and resultant autoimmune diseases. The autoimmune diseases can be broadly classified as (a) organ-specific autoimmune disease and (b) systemic autoimmune diseases

## Organ-Specific Autoimmune Diseases

These are diseases in which autoantibodies are produced targeting only the tissue of a single organ, thus affecting it solely. A few examples of such disorders are Addison's disease, autoimmune hemolytic anemia, Goodpasture's syndrome, Graves' disease, Hashimoto's thyroiditis, idiopathic thrombocytopenic purpura, insulin-dependent diabetes mellitus, myasthenia gravis, pernicious anemia, poststreptococcal glomerulonephritis, etc. These diseases can be further subgrouped on the basis of tissue damage as: (a) diseases mediated by the action of cell-mediated immunity and (b) diseases mediated by the action of autoantibodies.

### ► Diseases mediated by the action of cell-mediated immunity

Some of the diseases where the main mechanism of cell damage is directly mediated by lymphocytes are listed below:

**Hashimoto's thyroiditis:** Hashimoto's thyroiditis primarily is a subclinical disease in which no thyroid dysfunction is evident and no therapy is needed until the later stages of disease. A cell-mediated autoimmune reaction triggered by unknown factors is believed to be responsible for the development of this disease. The disease occurs most often in middle-aged women producing both autoantibodies and TH1 cells specific for thyroid antigens. It is the most common form of thyroiditis, and it usually has a chronic evolution. It occurs most commonly during the third to fifth decades, with a female to male ratio of 10:1. The disease is functionally characterized by a slow progression to hypothyroidism with an insidious onset of symptoms. Most patients become hypothyroid with symptoms of malaise, fatigue, cold intolerance, and constipation. The diagnosis is usually confirmed by the detection of antithyroglobulin antibodies.

**Addison's disease (chronic primary hypoadrenalism):** This disease can either be caused by exogenous agents (e.g., infection of the adrenals by *Mycobacterium tuberculosis*) or may be idiopathic. The idiopathic form is believed to have an immune basis, since 50% of patients have been found to have autoantibodies to the microsomes of adrenal cells (as compared to 5% in the general population). The autoantibodies directed against the adrenals are believed to play the main role in pathogenesis of the disease.

Symptoms of Addison's disease include weakness, fatigability, anorexia, nausea, vomiting, weight loss, and diarrhea. Signs include increased skin pigmentation, vascular collapse, and hypotension. The disease finally ends in atrophy and loss of function of the adrenal cortex. The diagnosis is confirmed by demonstration of antiadrenal antibodies by indirect immunofluorescence test. Addison's disease is found frequently in association with other autoimmune diseases, such as thyroiditis, pernicious anemia, and diabetes mellitus.

**TABLE 20-1 Autoimmune disorders**

Affected tissue	Disease	Self-antigen	Immune response
<b>Organ-specific autoimmune diseases</b>			
Adrenal cortex	Addison's disease	Adrenal cells	Autoantibodies
Erythrocytes	Autoimmune hemolytic anemia	RBC membrane protein	Autoantibodies
Kidneys and lungs	Goodpasture's syndrome	Renal and lung basement membrane	Autoantibodies
Thyroid gland	Graves' disease	Thyroid stimulation hormone receptor	Autoantibodies
Thyroid gland	Hashimoto's thyroiditis	Thyroid stimulation hormone receptor Antibodies to thyroglobulin. "Long acting thyroid stimulator"-IgG antibody to thyroid membrane.	Stimulating T cells and autoantibodies
Platelets	Idiopathic thrombocytopenic purpura	Platelet membrane protein	Autoantibodies
Pancreas	Insulin-dependent diabetes mellitus	Pancreatic beta cells	T <sub>H</sub> cells and autoantibodies
Skeleton muscle	Myasthenia gravis	Acetylcholine receptors	Autoantibodies
Stomach	Pernicious anemia	Gastric parietal cells, intrinsic factor	Autoantibodies
Kidney	Poststreptococcal glomerulonephritis	Basement membrane	Antigen-antibody complex
Sperm	Male sterility	Spermatogonia	Autoantibodies
<b>Systemic autoimmune diseases</b>			
Lower spine	Ankylosing spondylitis	Vertebrae	Immune complex
Myelin of CNS	Multiple sclerosis	Brain or white matter	T <sub>H</sub> , T <sub>C</sub> cells, and autoantibodies
Synovial membranes and joints	Rheumatoid arthritis	Connective tissue, IgG	Autoantibodies, and immune complex
Connective tissue	Scleroderma	Nuclei, heart, lungs, GI tract and kidney	Autoantibodies
Tear ducts	Sjögren's syndrome	Salivary gland, liver, kidney, thyroid	Autoantibodies
Skin, joints, vasculature, muscle, and kidney	Systemic lupus erythematosus	DNA, nuclear protein, RBC, and platelets	Autoantibodies, and immune complex

**► Diseases mediated by the action of autoantibodies**

In some autoimmune diseases, antibodies act as agonists, binding to hormone receptors in lieu of the normal ligand and stimulating inappropriate activity. This usually leads to an overproduction of mediators or an increase in cell growth. Conversely, autoantibodies may act as antagonists, binding hormone receptors but blocking receptor function. This generally causes impaired secretion of mediators and gradual atrophy of the affected organ. Some important representative disorders in this group are mentioned below:

**Myasthenia gravis:** Myasthenia gravis is the prototype autoimmune disease mediated by blocking antibodies. It is a disorder of neuromuscular transmission. A patient with this disease produces autoantibodies that bind the acetylcholine receptors on the motor end-plates of muscles. These antibodies block the normal binding of acetylcholine and also induce complement-mediated lysis of the cells. Increased muscular fatigue

and weakness, especially becoming more pronounced following exercise, are the usual symptoms of myasthenia gravis. Weakness is usually first detected in extraocular muscles resulting in diplopia or ptosis. The face, tongue, and upper extremities are also frequently involved. Skeletal muscle involvement is usually proximal. The disease is usually marked by spontaneous remission periods. Thymic abnormalities are frequent in myasthenia gravis. About 10% of the patients develop malignant tumors of the thymus (thymomas). The diagnosis is confirmed by the finding of antiacetylcholine receptor antibodies.

**Graves' disease:** Graves' disease, also known as thyrotoxicosis, diffuse toxic goiter, and exophthalmic goiter, occurs as a result of the production of autoantibodies against the thyrotrophic hormone (thyroid-stimulating hormone [TSH]) receptor (TSH receptor antibodies).

The TSH receptor antibodies (also known as long-acting thyroid stimulator, thyroid-stimulating immunoglobulin, and thyroid-stimulating antibodies) stimulate the activity of thyroid gland in Graves' disease. These antibodies have the

capacity to stimulate the production of thyroid hormones by activating the adenylate cyclase system after binding to the TSH receptor. These antibodies are detected in 80–90% of patients with Graves' disease and are usually of the IgG isotype.

Protruding eyeballs, also known as exophthalmos, is the classical presentation of the condition. Other symptoms of hyperthyroidism include increased metabolic rate with weight loss, nervousness, weakness, sweating, heat intolerance, and loose stools. This disease is more prevalent in women in their 30s.

Biopsy of the thyroid gland shows diffuse lymphoplasmacytic interstitial infiltration. Laboratory tests show increased levels of thyroid hormones (triiodothyronine, or T3, and thyroxine, or T4), increased uptake of T3, and antithyroid receptor antibodies.

## Systemic Autoimmune Diseases

The autoantibodies are produced against a wide range of host tissues in systemic autoimmune diseases. These diseases reflect a general defect in immune regulation that results in hyperactive T cells and B cells. Tissue damage is widespread, much more generalized and usually leads to multisystem disorders. Tissue damage is caused by cell-mediated immune responses, by autoantibodies, or by accumulation of immune complexes. A few of the representative systemic diseases are discussed below:

### ► Systemic lupus erythematosus

Systemic lupus erythematosus (SLE) is a generalized autoimmune disorder associated with multiple cellular and humoral immune abnormalities and protean clinical manifestations. It is most common in females of childbearing age. It is 10 times more common in females than males. The clinical manifestations of SLE vary among different patients. The kind of organ (vital versus nonvital) that becomes involved determines the seriousness and the overall prognosis of the disease. A wide range of autoantibodies to a vast range of tissue antigens, such as DNA, histones, RBCs, platelets, leukocytes, and clotting factors are produced in patients with SLE. Combination of these autoantibodies with their specific antigens produces a variety of symptoms.

Demonstration of lupus erythematosus (LE) cell on incubation of normal neutrophils with damaged leukocytes preincubated with sera obtained from SLE patients is typical of SLE. The cell is a peculiar-looking polymorphonuclear leukocyte that has ingested nuclear material.

Laboratory diagnosis of SLE is made by demonstration of antinuclear antibodies (ANAs) in a variety of tissues and cell lines as substrates by an indirect immunofluorescence test. Demonstration of nuclear fluorescence after incubating the cells with the patient's serum indicates a positive test. Four patterns of fluorescence can be seen, indicating different types of ANAs. The test for ANAs is not very specific but is very sensitive. A negative result virtually excludes the diagnosis of SLE

(95% of patients with SLE are ANA positive), while high titers are strongly suggestive of SLE but not confirmatory. False positives can occur in other systemic autoimmune/collagen diseases and chronic infections.

Anti-dsDNA antibodies are found almost exclusively in SLE (60–70% of the patients). Levels of serum anti-DNA antibodies may vary with disease activity, but they are poor predictors of disease activity. Marked elevations in the levels of circulating immune complexes can be detected in patients with SLE sera during acute episodes of the disease by a variety of techniques.

Sunlight exposure is the first environmental factor to be identified that influences the clinical evolution of SLE in a patient. Exposure to sunlight may precede the clinical expression of the disease or disease relapse. This is due to the Langerhans cells of the skin and keratinocytes that release significant amounts of interleukin-1 upon exposure to UV light. Infections and also drugs are responsible for setting off the disease process in certain susceptible individuals. Treatment of the condition is carried out by administration of corticosteroids and other anti-inflammatory drugs. Other examples of systemic autoimmune diseases include multiple sclerosis and rheumatoid arthritis.

## HLA Association with Autoimmune Diseases

The risk for many autoimmune diseases appears to be associated with the presence of particular human leukocyte antigen (HLA) genes. Some autoimmune diseases have increased frequencies in persons carrying certain HLA genes. Table 20-2 summarizes MHC association with some important autoimmune diseases.

TABLE 20-2

### MHC associations with autoimmune diseases

HLA gene	Disease
B8	Myasthenia gravis
B27	Acute uveitis
	Ankylosing spondylitis
	Reiter's disease
Cw6	Psoriasis vulgaris
DR2	Goodpasture's syndrome
	Multiple sclerosis
DR3	Graves' disease
	Multiple sclerosis
	Myasthenia gravis
	Systemic lupus erythematosus
DR4	Pemphigus vulgaris
	Rheumatoid arthritis
DR3/DR4 heterozygote	Type I insulin-dependent diabetes mellitus
DR5	Hashimoto's thyroiditis



# Immunology of Transplantation and Malignancy

# 21

## Introduction

Modern medicine continues to offer many miracles that lengthen the lifespan of humans, as well as greatly increase the quality of life they enjoy. The replacement of defective organs by transplantation was one of the impossible dreams of medicine for many centuries. The dream of health professionals have been to replace or restore damaged tissues or organs that are irreparably damaged.

The successful transplantation requires a multitude of important steps: surgical asepsis; development of surgical techniques of vascular anastomosis; genetic matching of donors with hosts; use of agents that could suppress the immune system; and prevention of infection in both recipient and donor. The development of strict antiseptic techniques contributes immensely to control the infection, while the proper use of immunosuppressive drugs and tissue typing increases the rate of success of transplantation.

## Transplant Immunology

Transplantation can be defined as the transfer of cells, tissues, or organs from one site in an individual to another, or between two individuals. In the latter case, the individual who provides the transplant organ is termed a **donor** and the individual receiving the transplant is known as the **recipient**.

## Types of Transplants

There are four different basic types of transplants. These reflect the genetic relationship of the donor to the recipient. The degree of immune response to a graft varies with the type of graft (Fig. 21-1).

- 1. Autograft:** An autograft is the transfer of individual's own tissue or organ from one site to another site in the body. In other words, the recipient is also the donor. Common examples of autografts include skin transplants in burn patients and bypass surgery in patients suffering from coronary heart disease.
- 2. Syngraft:** A syngraft is a transfer of tissue between two genetically identical individuals, i.e., identical twins. The first successful human kidney transplant was a syngraft, carried out in 1954 between identical twins.

- 3. Allograft:** An allograft is the transfer of tissue or an organ between genetically different members of the same species, i.e., from one human to another. This is the predominant form of transplantation today, and allografts have dominated transplant research for many years.
- 4. Xenograft:** A xenograft is the transfer of tissues or organs between members of different species. It represents the most disparate of genetic relationships and is always rejected by an immunocompetent recipient.

A major limitation in the success of transplantation is the immune response of the recipient to the donor tissue. Problem of rejection with autografts is usually minimal or absent. It is only when tissues from "others" are used, as in allografts and xenografts, the problem of rejection arises.

**Transplantation immunology** is the study of the events that occur after an allograft or a xenograft is removed from a donor and then transplanted into a recipient.

## Allograft Rejection

Allografts are rejected by a process called allograft reaction. Graft rejection is the consequence of an immune response mounted by the recipient against the graft as a consequence of

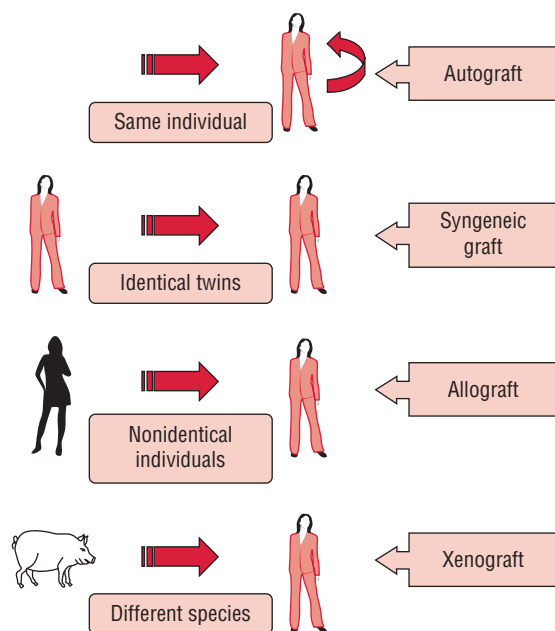

FIG. 21-1. Grafts in transplantation.

the incompatibility between tissue antigens of the donor and recipient. The problem of rejection was first recognized when attempts to replace damaged skin on burn patients with skin from unrelated donors were found to be relatively unsuccessful. During a period of 1–2 weeks, the skin would undergo necrosis and peel off. The failure of such grafts led scientists like Peter Medawar and many others to study skin transplantation in animal models. These experiments established that the failure of skin grafting was caused by an inflammatory reaction, now called as rejection. Results of several experimental studies imply that adaptive immune response is responsible for rejection.

**Histocompatibility antigens:** Cells expressing class II MHC (major histocompatibility complex) antigens play a major role in sensitizing the immune system of the recipient. The sensitization of alloreactive helper T lymphocytes from the recipient is followed by their clonal expansion. This in turn causes multiple immunological and inflammatory phenomena. Some of these phenomena are mediated by activated T lymphocytes and also by antibodies, which eventually result in graft rejection.

Recognition of transplanted cells as self or foreign is determined by polymorphic genes that are inherited from both parents and are expressed codominantly. MHC molecules are responsible for almost all strong rejection reactions. The rejection reactions are mediated by T cells. Both CD4 and CD8 cells coordinate to bring about an effective and pronounced rejection reaction. Nude mice, which lack a thymus, are incapable of launching an allogeneic immune response.

Histocompatibility is tissue compatibility as demonstrated in the transplantation of tissues or organs from one member to another of the same species (an *allograft*), or from one species to another (a *xenograft*).

### Key Points

- The major histocompatibility genes include class I and class II MHC genes that are important in tissue transplantation. These are the genes that encode antigens that should match if a tissue or organ graft is to survive in the recipient and are located in the MHC region. These are located on the short arm of chromosome 6 in humans and of chromosome 17 in the mouse.
- Minor histocompatibility antigens are the molecules expressed on cell surfaces that are encoded by the minor histocompatibility loci, not the major histocompatibility locus. They represent weak transplantation antigens than the major histocompatibility antigens. However, they are multiple and their cumulative effect may contribute considerably to organ or tissue graft rejection.

The greater the match between donor and recipient, the more likely the transplant is to survive. For example, a six-antigen match implies sharing of two HLA-A antigens, two HLA-B antigens, and two HLA-DR antigens between donor and recipient. Even though antigenically dissimilar grafts may survive when a strong immunosuppressive drug, such as cyclosporine, is used; the longevity of the graft is still improved by having as many antigenic match as possible.

### ► Mechanisms of graft rejection

Allogeneic MHC molecules are presented for recognition by the T cells of a graft recipient in two distinctly different ways: (a) direct presentation and (b) indirect presentation.

**Direct presentation:** Direct presentation involves recognition of an intact MHC molecule displayed by donor antigen-presenting cells (APCs) in the graft. It depends on the similarity in the structure of an intact foreign (allogeneic) molecule and self-MHC molecules.

Direct recognition of foreign MHC molecules is a cross-reaction of a normal T-cell receptor, which is selected to recognize a self-MHC molecule and foreign peptide, with an allogeneic MHC molecule and peptide. This is because an allogeneic MHC molecule with a bound peptide can mimic the determinant formed by a self-MHC molecule and a particular foreign peptide.

As many as 2% of an individual's T cells are capable of recognizing and responding to a single foreign MHC molecule, and this high frequency of T cells reactive with allogeneic MHC molecules is one reason that allografts elicit strong immune responses *in vivo*.

**Indirect presentation:** The “indirect presentation” involves the recognition of processed allogeneic MHC molecules but not an intact MHC molecule. It involves processing of donor MHC molecules by recipient APCs and presentation of derived peptides from the allogeneic MHC molecules in association with self-MHC molecules. Here the processed MHC molecules are recognized by T cells like conventional foreign protein antigens. Indirect presentation may result in allorecognition by CD4+ T cells. This is because alloantigen is acquired primarily through the endosomal vesicular pathway and is therefore presented by class II MHC molecules. Some antigens of phagocytosed graft cells appear to enter the class I MHC pathway of antigen presentation and are indirectly recognized by CD8+ T cells.

### ► Stages of cell-mediated graft rejection

Cell-mediated graft rejection could occur in two stages:

- (a) A sensitization phase, in which antigen-reactive lymphocytes of the recipient proliferate in response to alloantigens on the graft and
- (b) An effector stage, in which immune destruction of the graft takes place.

**Sensitization phase:** During the sensitization phase, CD4+ and CD8+ T cells recognize alloantigens expressed on the cells of foreign graft and proliferate in response. The response to major histocompatibility antigens involves recognition of both the donor MHC molecule and an associated peptide ligand in the cleft of the MHC molecule. The peptides present in the groove of allogeneic class I MHC molecules are derived from proteins synthesized within the allogeneic cell. The peptides present in the groove of allogeneic class II MHC molecules are generally proteins that are taken up and processed through the endocytic pathway of the allogeneic APC.

Recognition of the alloantigens expressed on the cells of a graft induces vigorous T-cell proliferation in the host. This proliferation can be demonstrated *in vitro* in a mixed lymphocyte reaction. Both dendritic cells and vascular endothelial

cells from an allogeneic graft induce host T-cell proliferation. The CD4+ T cell is the major proliferating cell that recognizes class II alloantigens directly or alloantigen peptides presented by host APCs. This amplified population of activated T<sub>H</sub> cells is believed to play a key role in inducing the various effector mechanisms of allograft rejection.

**Effector mechanisms in allograft rejection:** A variety of effector mechanisms participate in allograft rejection:

- The most common are cell-mediated reactions involving delayed-type hypersensitivity and cytotoxic T lymphocyte (CTL)-mediated cytotoxicity.
- Less common mechanisms are antibody plus complement lysis and destruction by antibody-dependent cell-mediated cytotoxicity (ADCC).

An influx of T cells and macrophages into the graft is the hallmark of graft rejection involving cell-mediated reactions. Histologically, the infiltration in many cases resembles that seen during a delayed-type hypersensitive response, in which cytokines produced by TD and T<sub>H</sub> cells promote macrophage infiltration. Recognition of foreign class I alloantigens on the graft by host CD8+ cells results in CTL-mediated killing. In some cases, CD4+ T cells that function as class II MHC-restrict cytotoxic cells mediate graft rejection.

### ► Clinical features of graft rejection

Rejection episodes, based primarily on the time elapsed between transplantation and the rejection episode, are traditionally classified as (a) hyperacute, (b) acute, and (c) chronic rejections.

**Hyperacute rejection:** Hyperacute rejection occurs usually within the first few hours post-transplantation and is mediated by preformed antibodies against ABO or MHC antigens of the graft. Possibly, antibodies directed against other alloantigens, such as vascular endothelial antigens, also play a role in this type of rejection.

Once the antibodies bind to the transplanted tissues, rejection can be caused either (a) by activation of the complement system, which results in the chemotactic attraction of granulocytes and the triggering of inflammatory circuits, or (b) by ADCC.

Pathological features of hyperacute rejection are following:

- This is associated with the formation of massive intravascular platelet aggregates leading to thrombosis, ischemia, and necrosis.
- The hyperacute rejection episodes are irreversible and invariably results in graft loss. With proper cross-matching techniques, this type of rejection is almost 100% avoidable.
- The hyperacute rejection by antibodies to all human cellular antigens is the major limitation of xenogeneic transplantation (e.g., pig to human).

**Acute rejection:** Acute rejection occurs mostly in the first few days or weeks after transplantation:

- When acute rejection takes place in the first few days after grafting, it may correspond to a secondary (second set) immune response. This indicates that the patient had been

previously sensitized to the HLA antigens present in the organ donor (as a consequence of a previous transplant, pregnancy, or blood transfusions).

- When graft rejection occurs first week after grafting, it usually corresponds to a first-set (primary) response. Up to 70% of graft recipients experience one or more acute rejection episodes.

Acute rejection is predominantly mediated by T lymphocytes. CD4+ helper T lymphocytes are believed to play the key role in acute rejection of the graft. This is because they release growth factors like IL-2 and IL-4 for the promotion of clonal expansion of CD8+ lymphocytes and B cells.

In rejected organs, the cellular infiltrates contain mostly monocytes and T lymphocytes of both helper and cytotoxic phenotypes, and lesser numbers of B lymphocytes, NK (natural killer) cells, neutrophils, and eosinophils. All these cells have the potential to play significant roles in the rejection process. The initial diagnosis of acute rejection is usually based on clinical suspicion:

- Functional deterioration of the grafted organ is the main basis for considering the diagnosis of acute rejection.
- Confirmation usually requires a biopsy of the grafted organ.
- Mononuclear cell infiltration in tissues of rejected graft tissue is characteristic finding.
- The measurement of cytokines (such as IL-2) in serum and in urine (in the case of renal transplants) is another diagnostic approach.

In most cases, acute rejection, if detected early, can be reversed by increasing the dose of immunosuppressive agents or by briefly administering additional immunosuppressants.

**Delayed or chronic rejection:** This is characterized by an insidiously progressive loss of function of the grafted organ. The functional deterioration associated with chronic rejection appears to be due to both immune and nonimmune processes. Vascular endothelial injury is the most common feature. Granulocytes, monocytes, and platelets are found to increasingly adhere to injured vascular endothelium. The damaged endothelium is covered by a layer of platelets and fibrin, and eventually by proliferating fibroblasts and smooth muscle cells. The end result is a proliferative lesion in the vessels, which progresses toward fibrosis and occlusion.

### ► Prevention of graft rejection

Immunosuppression of the host prevents graft rejection (Table 21-1). It is achieved by treatment with radiation, corticosteroids, and antilymphocyte serum. Cyclosporin A and rapamycin are also used, which cause immunosuppression by specific inhibition of T cells.

### Graft-Versus-Host Reaction

Whenever a patient with a profound immunodeficiency (primary, secondary, or iatrogenic) receives a graft of an organ rich in immunocompetent cells, there is a considerable risk

TABLE 21-1

## Immunosuppressive Agents used in Transplantation

Agent	Mode of action
Azathioprine	Inhibition of nucleotide synthesis of multiple cells
Cyclophosphamide	Inhibition of nucleotide synthesis of multiple cells
Cyclosporine	Inhibition of transcription of cytokines in lymphocytes
Corticosteroids	Inhibition of transcription for cytokines and products involved in inflammation in multiple cells
Sirolimus	Inhibition of transduction induced by cytokines in T cells
Irradiation	DNA damage in all rapidly proliferating cells
Anti-CD4 and CD8 antibodies	Interference with T-cell receptor binding of CD4 and CD8 T cells

that a graft-versus-host (GVH) reaction may develop. The probability of developing a GVH reaction is greatest in the 2-month period immediately following transplantation. GVH reactions require three important components, which are:

- the donor graft must contain immunocompetent T cells,
- the host must be immunocompromised, and
- the recipient should express antigens, such as MHC proteins, which will be identified as foreign to the donor. For example, donor T cells recognize the recipient cells as foreign.

### Key Points

GVH reactions are a significant problem in the following conditions:

- Transplantation of bone marrow or thymus in infants and children with primary immunodeficiencies.
- Transplantation of bone marrow in adults.
- Transplantations of small bowel, lung, and even liver—the organs that have substantial amount of lymphoid tissue.

Transplantation of organs, such as the heart and kidneys—poor in endogenous lymphoid tissue—very rarely results in a GVH reaction.

GVH reactions occur because the donor T lymphocytes become activated, proliferate, and differentiate into helper and effector cells in the irradiated, immunocompromised host. These activated T cells attack the host cells and tissues, producing the signs and symptoms of GVH disease. The donor's cytotoxic T cells play a key role in destroying recipient's cells. The crucial role played by the donor T cells is demonstrated by the fact that removal of these T cells from a bone marrow graft prevents GVH reactions.

The initial proliferation of donor T cells takes place in lymphoid tissues, particularly in the liver and spleen leading to hepatomegaly and splenomegaly. Later, at the peak of the proliferative reaction, the skin and intestinal walls are heavily infiltrated leading to severe skin rashes or exfoliative dermatitis and severe diarrhea. Finally, many GVH reactions end in overwhelming infections and death.

All immunosuppressive drugs used in the prevention and treatment of rejection have been used for treatment of the GVH reaction. Thalidomide, the tranquilizer drug that achieved notoriety due to its teratogenic effects, has been used

successfully for the control of chronic GVH unresponsive to traditional immunosuppressants.

## Tumor Immunology

Tumor immunology has been defined as part of immunology that deals with the antigens on tumor cells and the immune response to them. As a consequence of their loss of differentiation, tumor cells may express developmental antigens that are usually seen only in the prenatal period. Examples of these antigens are alpha-fetoprotein and carcinoembryonic antigen. Tumors or neoplasia is said to develop when the balance between cell death and renewal is disturbed in a way that numerous clones of a single cell group are produced in an uncontrolled fashion.

### Key Points

- A tumor that is not capable of indefinite growth and does not invade the healthy surrounding tissue extensively is **benign**.
- A tumor that continues to grow and becomes progressively invasive is **malignant**; the term cancer refers specifically to a malignant tumor.
- In addition to uncontrolled growth, malignant tumors exhibit **metastasis**; in this process, small clusters of cancerous cells dislodge from a tumor, invade the blood or lymphatic vessels, and are carried to other tissues, where they continue to proliferate. In this way a primary tumor at one site can give rise to a secondary tumor at another site.

## Features of Malignant Cells

Malignant cells show the following features:

1. Once cells become malignant, they stop functioning normally and add to the burden on the body by competing with the normal cells for space and nutrition.
2. The more “undifferentiated” a cell is, the lesser its functionality and more its malignant nature.
3. They undergo rapid and uncontrolled division.
4. They lose their homing instinct and start invading the basement membrane and enter the vasculature to spread to dissimilar tissues, leading to metastasis and spread of cancer.

It has been postulated that the immune system is responsible in part for the protection of the body against the development of malignancies. At the same time, the prevalence of numerous cancers in immunocompetent individuals indicates that immune system has only a partial role in protecting against malignancies and also that it is not very efficient at it.

## Tumor Antigens

Tumor cells also express unique molecules that can be classified into two groups:

1. Tumor-specific antigens
2. Tumor-associated transplantation antigens

### ► Tumor-specific antigens

The tumor-specific antigens (TSAs), also called tumor-specific transplantation antigens, are unique to tumors. They are not found on other cells of the body. They are usually the products of mutated genes seen in the cancer cells. Cytosolic processing of the abnormal proteins yields peptides that are unique and when presented by the appropriate MHC class I molecules elicit a cell-mediated immune response.

Various physical and chemical carcinogens cause malignancies by inducing mutation in key genes involved in modulating cell growth. *Ras proto-oncogene* products including the p21 Ras proteins and other related gene products are an example of TSAs. Ras proteins bind guanine nucleotides (GTP and GDP) and possess intrinsic GTPase activity. The mutations associated with Ras genes in malignant cells appear to cause a single amino acid substitutions at specific positions (12, 13, or 61), which results in increased enzymatic activity of the gene product. As a consequence, the cells acquire transforming capacity. Moreover, these products are also recognized as foreign antigens by the cellular immune response.

Another mode through which the tumor cells may express unique and novel antigens “is by” integration with proviral genomes. These virus-induced tumors usually have their genome integrated with proviral genome, hence the proteins encoded and expressed are sometimes novel and recognized by the cellular immune response. Viruses that have been implicated in tumorigenesis include Epstein–Barr virus (EBV), hepatitis B virus (HBV), hepatitis C virus (HCV), etc.

### ► Tumor-associated transplantation antigens

Tumor-associated transplantation antigens (TATAs) are the other class of tumor antigens. These antigens are expressed by (a) tumor cells and also by (b) normal cells at low levels or only during the process of differentiation. The expression of these antigens is considerably derepressed or enhanced after the process of malignant transformation. TATAs can be of the following types:

1. **Tumor-associated carbohydrate antigens:** They represent abnormal form of mucin-associated antigen detected in breast and pancreatic cancers.
2. **Differential antigens:** These include CD10 and prostate-specific antigens (PSA). The latter is used as a diagnostic indicator in prostatic cancer.

**3. Oncofetal antigens:** These antigens are found in embryonic and malignant cells but are absent in normal adult cells. Alpha-fetoprotein and carcinoembryonic antigens are examples of this antigen, which are found in hepatomas and colonic cancers, respectively. Silent tumor-associated genes are not expressed in normal cells but are actively transcribed in tumor cells. Tissue-specific genes or differentiation genes are present in the surface of normal cells or may be shed to the circulation, but the levels of expression are usually very low in normal cells. This finds practical application in the diagnosis of malignancies as illustrated by the assay of PSA for the diagnosis of carcinoma of prostate.

**PSA:** It is a kallikrein-like serine protease produced exclusively by the epithelial cells in the prostate gland. The antigen is detectable at relatively high levels in seminal plasma and at very low levels in the serum of healthy men. The assay of serum PSA levels is a very useful marker of prostate carcinoma, perhaps the most meaningful serum marker for neoplasia. In healthy men, the levels of PSA vary between  $0.65 \pm 0.66$  ng/mL at ages 21–30 and  $1.15 \pm 0.68$  ng/mL at ages 61–70. Significantly elevated levels are demonstrated in 63–86% of patients with prostatic carcinoma, depending on the stage. In essence, antigens of tumors that are capable of eliciting an immune response may be one of the following nature:

- First, these antigens are uniquely expressed by tumor cells alone. Also, there are the products of genes that have been mutated during the process of transformation, leading to the expression of abnormal products.
- Second, certain antigens expressed by tumors are present only when normal cells are undergoing the process of differentiation and these are also readily recognized by the immune system.
- Finally, the antigens that are overexpressed by the tumor cells elicit a good immune response.

## Immune Reactions against Tumors

Tumor antigens are capable of eliciting a comprehensive immune response involving both the cellular and humoral immune responses.

### ► Cellular immune responses

T lymphocytes play an important role in tumor immunity. They act both as cytotoxic effector cells and as central modulating cells. Through these effector cells, they control the specific cell-mediated antitumor immune responses and upregulate non-specific killing mechanisms. The activation of T lymphocytes by tumor cell products as a consequence of antigen recognition may result in the secretion of nonspecific immunoregulatory factors.

- These factors are capable of “upregulating” the tumor-killing function of mononuclear phagocytes, NK cells, and granulocytes.
- These factors also enhance the ability of NK cells and monocytes to participate in ADCC against tumor cells.
- Macrophages also play an important role in tumor response. Clustering of macrophages around tumor cells is associated with tumor regression and seen in the case of numerous cancers.

### ► Humoral immune responses

B lymphocytes produce tumor-specific antibodies, which may induce complement-dependent cytotoxicity of tumor cells or may mediate ADCC. ADCC can be mediated by a variety of cells expressing Fcγ receptors (NK cells, monocytes or macrophages, and granulocytes) by recognizing and destroying IgG-coated tumor cells.

### Immunosurveillance

The emergence of cancer cells within the body may not be a rare or unusual event at all. Of the trillions of normal cells found in the body, several hundred per day may be undergoing malignant degeneration in response to the cancer-promoting stimuli. The immune system may possibly play a significant role in halting the growth of these cells and preventing the development of overt malignancy.

The concept of immune surveillance was initially put forward by Ehrlich, and later on modified by Thomas and Burnet. Ehrlich first suggested that though cancer cells frequently arise in the body, they are recognized as foreign and eliminated. Later, Burnet postulated the immunosurveillance theory. He suggested that the immune system routinely patrols the cells of the body and upon recognition of a cell or a group of cells that has become cancerous attempts to destroy them, thus preventing the growth of some tumors.

### Immunotherapy of Cancer

Immunotherapy of cancer can be considered as the following two broad groups:

1. Antigen-nonspecific treatment
2. Antigen-specific treatment

### ► Antigen-nonspecific treatment

This includes treatment with various nonspecific immune modulators.

- Bacillus Calmette–Guérin (BCG) vaccine has been shown to possess antitumor activity. The vaccine when injected directly into certain solid tumors may cause regression of tumor. Antitumor effect of tumor is believed to be due to activation of macrophages and NK cells. The BCG therapy has been reported to be beneficial in treatment of bladder cancer, malignant melanomas, stage I lung cancer, and certain leukemias.
- *Corynebacterium parvum* also possesses antitumor activities. Its antitumor effect is due to its ability to stimulate macrophages and B cells. It shows a synergistic effect when used in conjunction with cyclophosphamide. It is found to be useful in treatment of metastatic breast cancer and various types of lung cancer.
- Other nonspecific immune modulators include (i) dinitrochlorobenzene (DNCB), evaluated in squamous and basal carcinoma, (ii) levamisole for stimulating cell-mediated immunity and macrophage function, (iii) interferon to stimulate NK cell function, (iv) cytokine IL-2 to stimulate killing of cancer cells by cytotoxic T cells, (v) NK cells, and macrophages, thymic hormones to restore T cell function, and (vi) tuftsin to stimulate phagocytic cells.

### ► Antigen-specific treatment

Antigen-specific treatment includes (a) vaccination with tumor antigen, (b) treatment with transfer factor, (c) treatment with immune RNA, (d) treatment with monoclonal antibodies raised against tumor-associated antigens (TAAs) given alone or in conjunction with cytotoxic drug, and (e) modification of tumor antigenicity by treatment with neuraminidase.

# Immunohematology

## Introduction

Immunohematology is the study of blood group antigens and antibodies, and their interactions in health and disease. Ehrlich and Morgenroth first described blood groups in goats based on antigens of their red cells in an article published in the *Berliner klinische Wochenschrift* in 1900. Subsequently, Karl Landsteiner, a Viennese pathologist, successfully identified the human ABO blood groups for which he was awarded the Nobel Prize 30 years later. After this initial discovery, blood grouping was developed as a science, and many different systems of grouping were designed on the basis of many isoantigens on the surface of erythrocytes. The ABO and Rh systems are among the well-known human blood groups described in the literature.

## ABO Blood Group System

ABO blood group system was the first human red-cell antigen system to be characterized. The ABO blood group substances are glycopeptides with oligosaccharide side chains (Fig. 22-1). The ABO blood group specificity is determined by the presence of terminal sugar in an oligosaccharide structure. The terminal sugars of the oligosaccharides are specific for blood groups A and B. They are also immunogenic. The red cells express either A, B, both A and B, or neither, and antibodies are found in serum to antigens not expressed by the red cells.

## ABO Blood Group Antigens

The blood group of an individual is determined by presence or absence of two antigens, A and B, on the surface of the red cell membrane. Red cells of blood group A carry antigen A, cells of blood group B carry antigen B, and cells of blood group AB have both A and B antigens. On the other hand, blood group O cells have neither A nor B antigens.

The blood groups are also differentiated by the presence or absence of two distinct isoantibodies in the serum. Serum of blood group A individuals have anti-B antibodies, blood group B have anti-A antibodies, and blood group O have both anti-A and anti-B antibodies. The blood group AB does not contain any anti-A and anti-B antibodies in the serum.

Soluble ABO blood group substances may be found in mucous secretions of humans, such as saliva, gastric juice, ovarian cyst fluid, etc. Such persons are termed secretors, while those without the blood group substances in their secretions are nonsecretors.

The ABO group of a given individual is determined by testing both cells and serum. In this method, the subject's red cells are mixed with serum containing known antibody and the subject's serum is tested against cells possessing known antigen. For example, the cells of a group A individual are agglutinated by anti-A serum but not by anti-B serum, and his or her serum agglutinates type B cells but not type A cells. The typing of cells as group O is done by exclusion (a cell not reacting with anti-A or anti-B is considered to be of blood group O). It is

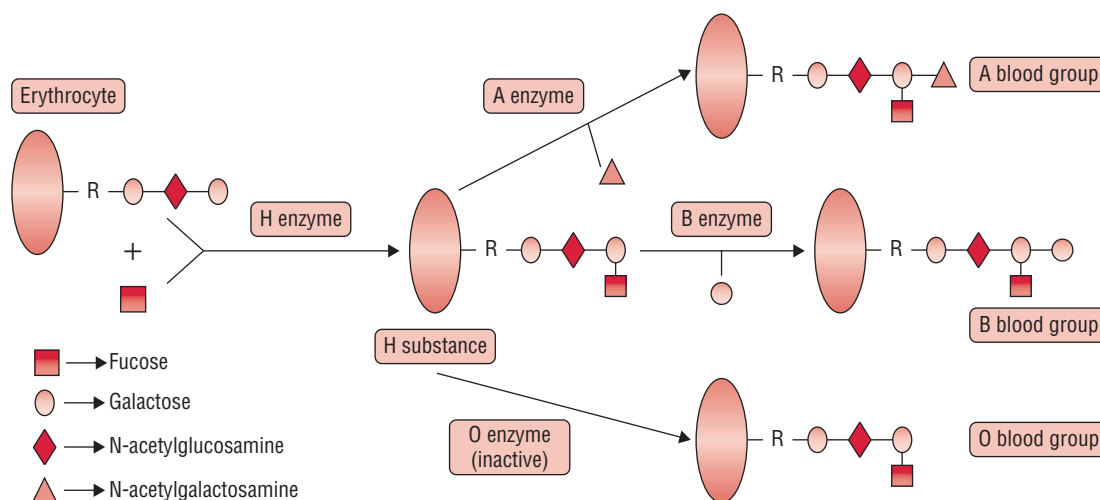

FIG. 22-1. ABO blood group system.

noteworthy that these antibodies to the isoantigens are found in all individuals including those that have had no transfusions.

It is believed that the anti-A and anti-B isoagglutinins are synthesized as a consequence of cross-immunization with bacteria of the family Enterobacteriaceae that colonize the infants' gut. These bacteria have outer membrane oligosaccharides strikingly similar to those that define the A and B antigens in the human body. For example, a newborn with group A will not have anti-B in his or her serum, since there has been no opportunity to undergo cross-immunization. When the intestine is eventually colonized by the normal microbial flora, the infant will start to develop anti-B, but will not produce anti-A because of tolerance to his or her own blood group antigens. The inheritance of the ABO groups follows simple Mendelian rules, with three common allelic genes: A, B, and O (A can be subdivided into A1 and A2), and any individual will carry two alleles, one inherited from the mother and one from the father.

### ▶ H antigen

Red cells of all ABO groups possess a common antigen, the H antigen, or H substance. H antigen is a glycoprotein and structurally is an L-fucose. It is a precursor for the production of A and B antigens. A and B antigens are formed by addition of N-acetylgalactosamine and galactose, respectively, to L-fucose of H antigen.

The H antigen, due to its universal distribution, is not that important in blood grouping or transfusion. However, in rare instances, such as in "Bombay," or OH blood, both A and B antigens as well as H antigens are absent in the blood. Individuals with "Bombay" blood group have anti-A, anti-B, and anti-H antibodies, hence are not compatible with most of the red cells.

## Rh Blood Group System

Philip Levine, in 1939, discovered that the sera of most women who gave birth to infants with hemolytic disease contained an antibody that reacted with the red cells of the infant and with the red cells of 85% of Caucasians. In 1940, Landsteiner and Wiener injected blood from the monkey *Macacus rhesus* into rabbits and guinea pigs, and discovered the resulting antibody agglutinated rhesus (Rh) red cells, which appeared to have the same specificity as the neonatal antibody. The donors whose cells were agglutinated by the antibody to Rh red cells were termed **Rh positive**; those whose cells were not agglutinated were termed **Rh negative**. It is now known that the antibody obtained by Landsteiner and Wiener reacts with an antigen (LW) is different but is closely related to the one that is recognized in human hemolytic disease, but nevertheless the Rh nomenclature is still retained.

### Rh Blood Group Antigens

The term Rh blood group system refers to the five main Rh antigens (C, c, D, E, and e) as well as many other less frequent Rh antigens. The terms Rh factor and Rh antigen are similar, and both refer to the RhD antigen only. Of all the Rh antigens, antigen D (RhD) is most important.

### ▶ D antigen

Individuals either have or do not have the RhD antigen on the surface of their red blood cells. This is usually indicated by "RhD positive" (does have the RhD antigen) or "RhD negative" (does not have the antigen) suffix to the ABO blood type. This suffix is often shortened to "D pos"/"D neg," "RhD pos"/"RhD neg," or +/- . The latter symbol is generally not preferred in research or medical situations, because it can be altered or obscured accidentally. There are several alloantigenic determinants within the Rh system.

- Clinically, the D antigen has a lot of medical importance. This is because RhD negative individuals who receive RhD positive erythrocytes by transfusion can develop alloantibodies that may lead to severe reactions with further transfusions of RhD-positive blood.
- The D antigen also poses a problem in RhD-negative mothers who bear a child with RhD-positive red cells inherited from the father. The entry of fetal erythrocytes into the maternal circulation at parturition or trauma during the pregnancy (such as in amniocentesis) can lead to alloimmunization against the RhD antigen. This may cause hemolytic disease of the newborn in subsequent pregnancies. This can now be prevented by the administration of Rh (D) immunoglobulin to these women within 72 hours of parturition.

Unlike ABO system, there are no natural antibodies against Rh antigens. Antibodies against Rh antigens develop only in certain situations, such as in Rh incompatible pregnancy or transfusion. Most of these antibodies are IgG antibodies, and few IgM antibodies. These are incomplete antibodies and can be detected in newborn blood by direct Coombs' test and in mother blood by indirect Coombs' test.

## Blood Transfusion

Blood transfusion is the process of transferring blood or blood-based products from one person into the circulatory system of another. Blood transfusions have many indications as mentioned below:

- Blood transfusions can be life-saving in some situations, such as massive blood loss due to trauma, or can be used to replace blood lost during surgery.
- Blood transfusions may also be used to treat a severe anemia or thrombocytopenia caused by a blood disease.
- People suffering from hemophilia or sickle-cell disease may require frequent blood transfusions.

Before a blood transfusion, a series of procedures need to be done to establish the proper selection of blood for the patient. Basically, those procedures try:

- to establish ABO and Rh compatibility between donor and recipient and
- to rule out the existence of antibodies in the recipient's serum, which could react with transfused red cells.



To establish the ABO and Rh compatibility between donor and recipient, both the recipient and the blood to be transfused are typed. The most direct way to detect antibodies in the recipient's serum that could cause hemolysis of the transfused red cells is to test the patient's serum with the donor's cells (major cross-match). The minor cross-match, which consists of testing a patient's cells with donor serum is of little significance and rarely performed, since any donor antibodies would be greatly diluted in the recipient's plasma, and rarely, it causes clinical problems.

**Universal recipient:** It is an ABO blood group individual whose red blood cells express antigens A and B, but whose serum does not contain anti-A and anti-B antibodies. Thus, red blood cells containing any of the ABO antigens, i.e., from an individual with type A, B, AB, or O, may be transfused to the universal recipient without inducing a hemolytic transfusion reaction.

It is best if the universal recipient is Rh positive, i.e., has the RhD antigen on the erythrocytes to avoid developing a hemolytic transfusion reaction. However, blood group systems other than ABO may induce hemolytic reactions in a universal recipient. Thus, it is best to use type-specific blood for transfusions.

**Universal donor:** It is a blood group O RhD-negative individual whose erythrocytes express neither A nor B surface antigens. This type of red blood cell fails to elicit a hemolytic transfusion reaction in recipients with blood group A, B, AB, or O. However, group O individuals serving as universal donors may express other blood group antigens on their erythrocytes that may induce hemolysis. It is preferable to use type-specific blood for transfusions, except in cases of disaster or emergency.

## Complications of Blood Transfusion

Transfusion reaction is the major immunological complication following incompatible blood transfusion. Other transfusion reactions may be caused due to factors other than incompatibility, such as a person being hypersensitive to some allergens present in the blood. Transmission of infectious agents through blood is the most important complication. These include:

- Viruses, such as human immunodeficiency viruses I and II (HIV I and II), hepatitis B virus (HBV), hepatitis C virus (HCV), hepatitis D virus (HDV), and cytomegalovirus (CMV);
- Bacteria, such as *Treponema pallidum* and *Leptospira interrogans*; and
- Protozoa, such as *Toxoplasma gondii*, *Leishmania donovani*, and *Plasmodium* species.
- Transmission of HIV I and II, HBV, and HCV, which is a major concern.

## Hemolytic Disease of Newborn (Erythroblastosis Fetalis)

Hemolytic disease of the newborn, also known as HDN, is an alloimmune condition. It develops in a fetus, which contains the IgG antibodies that have been produced by the mother and have passed through the placenta. These antibodies subsequently

attack and lyse the red blood cells in the fetal circulation, resulting in reticulocytosis and anemia. This condition in fetus varies from mild to very severe, and fetal death may occur due to heart failure (*hydrops fetalis*). When the disease is moderate or severe, many erythroblasts are present in the fetal blood, and this form of the disease is called *erythroblastosis fetalis*.

Immunological destruction of fetal and/or newborn erythrocytes is likely to occur when IgG antibodies are present in the maternal circulation directed against the antigen(s) present on the fetal red blood cells. This is because only IgG antibodies can cross the placenta and reach the fetal circulation. Anti-D and anti-A or anti-B are the two types of antibodies most usually involved in hemolytic disease of the newborn. Anti-A or anti-B antibodies are usually IgM, but, in some circumstances, IgG antibodies may develop (usually in group O mothers). This can be secondary to immune stimulation (some vaccines contain blood group substances or cross-reactive polysaccharides), or may occur without apparent cause for unknown reasons.

Antibodies are produced when the body is exposed to an antigen foreign to the make-up of the body. If a mother is exposed to an alien antigen and produces IgG (as opposed to IgM which does not cross the placenta), the IgG will combine with the antigen, if present in the fetus, and may affect it *in utero* and persist after delivery (Fig. 22-2).

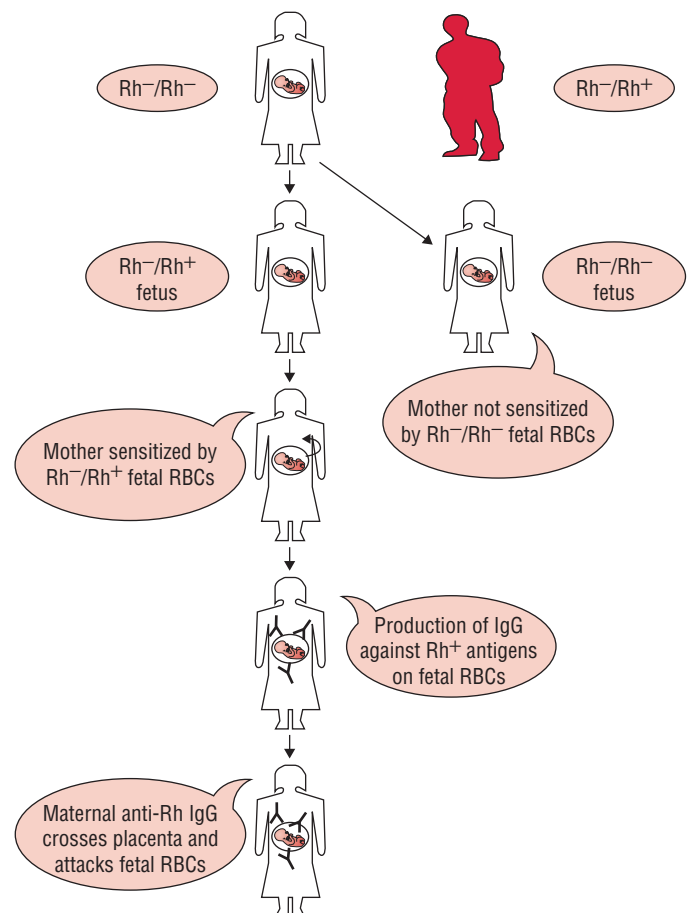

FIG. 22-2. Hemolytic diseases of newborn.

The three most common ways in which a woman becomes sensitized (i.e., produces IgG antibodies against) toward particular blood types are as follows:

1. Fetal–maternal hemorrhage can occur due to trauma, abortion, childbirth, ruptures in the placenta during pregnancy, or medical procedures carried out during pregnancy that breach the uterine wall. In subsequent pregnancies, if there is a similar incompatibility in the fetus, these antibodies then cross the placenta into the fetal bloodstream, combine with the red blood cells, and finally cause hemolysis. In other words, if a mother has anti-RhD (D being the major Rh antigen) IgG antibodies as a result of previously carrying an RhD-positive fetus, these antibodies will only affect a fetus with RhD-positive blood.
2. The woman may receive a therapeutic blood transfusion with an incompatible blood type. ABO blood group system and Rh blood group system typing are routine prior to transfusion. Suggestions have been made that women of childbearing age or young girls should not be given a transfusion with Rhc-positive blood or Kell-positive blood to avoid possible sensitization. However, it is considered uneconomical to screen for these blood groups.
3. The third sensitization model can occur in women of blood type O. The immune response to A and B antigens, which are widespread in the environment, usually leads to the production of IgM anti-A and IgM anti-B antibodies early in life. On rare occasions, IgG antibodies are produced. In contrast, Rhesus antibodies are generally not produced from exposure to environmental antigens.

A positive direct Coombs' (antiglobulin) test with cord RBC is invariably positive in cases of Rh incompatibility. In ABO incompatibility, the direct antiglobulin test is usually weakly positive and may be confirmed by eluting antibodies from the infant's red cells and testing the elute with A and B cells.

Before birth, treatment of the condition include intrauterine transfusion or early induction of labor when (a) pulmonary maturity has been attained, (b) fetal distress is present, or (c) 35–37 weeks of gestation have passed. The mother is also administered with plasma to reduce the circulating levels of antibody by as much as 75%.

After birth, treatment depends on the severity of the condition. These include temperature stabilization, phototherapy, transfusion with compatible packed red blood cells, administration of sodium bicarbonate for correction of acidosis, and/or assisted ventilation and exchange transfusion with a blood cells, type compatible with both the infant and the mother.

Rh-negative mothers who have had a pregnancy with or are pregnant with an Rh-positive infant are given Rh immunoglobulin (RhIG) during pregnancy and after delivery to prevent sensitization to the D antigen. The RhIG acts by binding any fetal red cells with the D antigen before the mother is able to produce an immune response and form anti-D IgG.

All the offsprings of Rh-incompatible marriages, however, do not suffer from hemolytic diseases of newborn. This may be due to either of the following causes:

**1. Mother–fetus ABO incompatibility:** When the mother and fetus possess the same ABO group, Rh immunization is more likely to occur. However, when Rh and ABO incompatibility coexist, Rh sensitization from the mother is very rare. In this condition, the fetal cells entering the maternal circulation are destroyed rapidly by the ABO antibodies before they can form the Rh antibodies.

**2. Immune unresponsiveness to Rh antigen:** Some Rh-negative individuals even after repeated injections of Rh-positive cells fail to form Rh antibodies. Such individuals are known as nonresponders. The exact reason for such immunological unresponsiveness, however, is not known.

**3. Number of pregnancies:** The risk of hemolytic disease of new born is more in second and successive child, but not in first child. This is because sensitization occurs only during the delivery; hence the first child escapes.

## ABO Hemolytic Diseases

ABO hemolytic diseases occur in a very less number of cases, even though materno-fetal ABO incompatibility is very common. The condition is usually seen in O group mothers bearing blood group A or B fetus. It occurs largely in O group mothers because the isoantibodies are largely IgG in nature, which can cross the placenta. It does not occur in mothers with blood groups A or B because natural antibodies are mainly IgM in nature, which does not cross the placenta and sensitize the fetus.

Unlike hemolytic disease of the newborn, the ABO hemolytic diseases can occur even in first child even without prior immunization. This is because the ABO disease is caused by naturally occurring maternal isoantibodies.

ABO hemolytic disease is much milder condition than that of the Rh disease. The diagnosis of ABO incompatibility is made by a positive indirect Coombs' test but a negative direct Coombs' test. Peripheral blood smear characteristically shows spherocytosis.

"This page intentionally left blank"

"This page intentionally left blank"

# Staphylococcus

## Introduction

Family Micrococcaceae consists of Gram-positive cocci, which are aerobic and anaerobic, and are arranged in tetrads or clusters. Micrococcaceae consists of four genera, *Staphylococcus*, *Micrococcus*, *Planococcus*, and *Stomatococcus*. Differences between these genera are summarized in Table 23-1.

Human infections caused by these genera are summarized in Table 23-2. Among these, *Staphylococcus* is the only genus of medical importance.

## Staphylococcus

The genus *Staphylococcus* consists of 32 species, most of which are animal pathogens or commensals. The bacteria belonging to this genus are aerobic and facultative anaerobic, catalase positive, oxidase negative, and are arranged in clusters, pairs, or tetrads.

TABLE 23-1

### Features distinguishing *Staphylococcus*, *Micrococcus*, and *Planococcus*

Characters	<i>Staphylococcus</i>	<i>Micrococcus</i>	<i>Planococcus</i>
Arrangement of bacteria	Clusters	Clusters/ Tetrads	Tetrads
Presence of teichoic acid	+	–	–
Production of brown pigment	–	–	+
Glucose fermentation	+	+	–

TABLE 23-2

### Human infections caused by *Staphylococcus*, *Micrococcus*, and *Stomatococcus*

Bacteria	Diseases
<i>Staphylococcus aureus</i>	Skin infections—impetigo, folliculitis, furuncle, carbuncle, paronychia, wound infection Systemic infections—bacteremia, osteomyelitis, septic arthritis, endocarditis, pneumonia, meningitis, deep-seated abscess Toxin-mediated infections—food poisoning, toxic shock syndrome, staphylococcal scalded skin syndrome
<i>Staphylococcus epidermidis</i>	Opportunistic infections—intravenous catheter infections, CSF shunt infections, and catheter-associated peritonitis endocarditis in “immunocompromised” patients
<i>Staphylococcus saprophyticus</i>	Urinary tract infection particularly in sexually active young women
<i>Micrococcus</i> spp.	Opportunistic infections
<i>Stomatococcus</i> spp.	Opportunistic infections, bacteremia, endocarditis

- *Staphylococcus aureus* is the most important human pathogen.
- The other important human pathogens are coagulase-negative staphylococci (CONS), which include *Staphylococcus epidermidis*, *Staphylococcus saprophyticus*, *Staphylococcus haemolyticus*, *Staphylococcus hominis*, *Staphylococcus warneri*, *Staphylococcus saccharolyticus*, *Staphylococcus schleiferi*, and *Staphylococcus lugdunensis*. Staphylococci are capable of acquiring resistance to many antibiotics and therefore can cause major clinical and epidemiological problems in hospitals.

## Staphylococcus aureus

*S. aureus* is an important human pathogen that causes a spectrum of clinical diseases. These range from superficial skin lesions like folliculitis to deep-seated abscess and various pyogenic infections like endocarditis, osteomyelitis, etc. The bacterium also causes toxin-mediated diseases, such as food poisoning, toxic shock syndrome (TSS), and staphylococcal scalded skin syndrome (SSSS).

## Properties of the Bacteria

### ► Morphology

Staphylococci show following features:

- They are Gram-positive cocci, measuring around 1  $\mu\text{m}$  in diameter.
- They are nonmotile, nonsporing.
- They are noncapsulated. They, however, contain a microcapsule, which can be visualized by electron microscope only, but not by a light microscope.

The cocci are typically arranged in irregular grape-like clusters. This appearance is due to incomplete separation of daughter cells during successive divisions of bacteria, which takes place in perpendicular planes. The grape-like clustering is seen when the bacteria are grown in solid media, but usually short chains are seen when grown in liquid media.

In smears taken from pus, the cocci are present either singly or in pairs, in clusters, or in short chains of three or four cells.

### ► Culture

Staphylococci are aerobes and facultative anaerobes but can grow in the absence of oxygen also. They grow at a temperature range of 10–42°C (optimum temperature 37°C) and a pH range of 7.4–7.6 (optimum pH 7).

**Culture on solid media:** Staphylococci can grow on a wide range of media including Mueller–Hinton agar, nutrient agar, blood agar, and MacConkey agar. Primary isolation can be made on nutrient agar and blood agar.

1. **Nutrient agar:** *S. aureus* produces round, convex, well-defined colonies measuring 2–4 mm in diameter. The colonies show a butyrous consistency with a smooth glistening surface.

*S. aureus* produces characteristic golden-yellow colonies due to production of a nondiffusible golden-yellow pigment. The pigment is believed to be a lipoprotein allied to carotene. The production of the pigment is enhanced by incubation at 22°C in the presence of oxygen. Milk agar and 1% glycerol monoacetate agar are other media that facilitate the production of pigment. On nutrient agar slopes, the growth gives a characteristic “oil paint” appearance.

2. **Blood agar:** *S. aureus* produces a clear zone of hemolysis (beta-hemolysis) surrounding the colonies (Fig. 23-1,

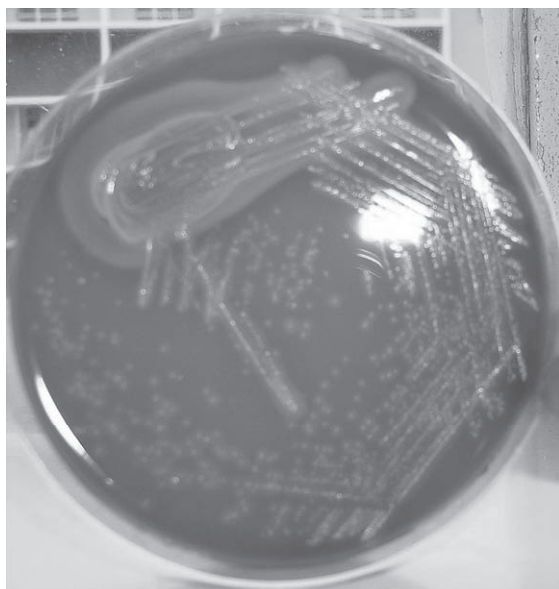

**FIG. 23-1.** Blood agar plate showing beta-hemolysis surrounding the colonies of *Staphylococcus aureus*.

Color Photo 12). Hemolysis is well marked on sheep or rabbit blood agar, especially when incubated in an atmosphere of 20–25% CO<sub>2</sub>. Sheep blood agar is used for primary isolation.

Hemolysis is weak on horse blood agar. Human blood is not used, as it may contain antibiotics or other inhibitors. Other species of *Staphylococcus* do not produce hemolysis.

3. **MacConkey agar:** *S. aureus* produces small pink colonies due to fermentation of lactose.
4. **Selective media:** Mannitol salt agar, milk agar, and glycerol monoacetate agar are the commonly used selective media for isolation of *S. aureus* from clinical specimens containing normal bacterial flora (e.g., stools). Mannitol salt agar contains 1% mannitol, 7.5% sodium chloride, and 0.0025% phenol red indicator. Most strains of *S. aureus* ferment mannitol with acid production, which gives rise to yellow zone formation around the colonies.

**Culture in liquid media:** *S. aureus* produces turbidity in liquid media and there is no production of pigment.

### ► Biochemical reactions

*S. aureus* shows following reactions:

- It is coagulase positive. The production of coagulase is used as a test to differentiate *S. aureus* from *S. epidermidis* and other CONS.
- It is phosphatase positive. Phosphatase production can also be used to differentiate *S. aureus* from *S. epidermidis*, as the latter either does not produce or has very weak phosphatase activity.
- It is catalase positive. It produces enzyme catalase (unlike *Streptococcus*), which degrades H<sub>2</sub>O<sub>2</sub> into nascent oxygen and water.
- It is oxidase negative.
- *S. aureus* ferments mannitol, sucrose, maltose, and trehalose under aerobic conditions, with the production of acid but no gas. Fermentation of mannitol is of diagnostic importance, because most strains of *S. aureus* ferment mannitol while those of *S. epidermidis* and *S. saprophyticus* do not ferment mannitol.
- It liquefies gelatin, hydrolyzes urea, reduces nitrate to nitrite, and is “Voges-Proskauer (VP)” and “methyl red (MR)” positive but indole negative.

### ► Other properties

**Susceptibility to physical and chemical agents:** The cocci withstand moist heat at 60°C for 30 minutes but are killed after 30 minutes. They are also killed rapidly by disinfectants, such as phenol, chlorhexidine, and hexachlorophene. The cocci are very sensitive to aniline dyes, such as crystal violet. The dye at a concentration of 1:500,000 inhibits the growth of the cocci on blood agar medium but permits the growth of streptococci.

## Cell Wall Components and Antigenic Structure

Cell wall associated proteins and polymers include the following (Fig. 23-2):

### ▶ Cell wall peptidoglycan

*S. aureus* cell wall is rich in peptidoglycans. Peptidoglycan is a polymer of the polysaccharide, which provides rigidity to the cell wall of the bacteria. It has the characteristic penta glycine bridges that link tetrapeptides to the muramic acid residues.

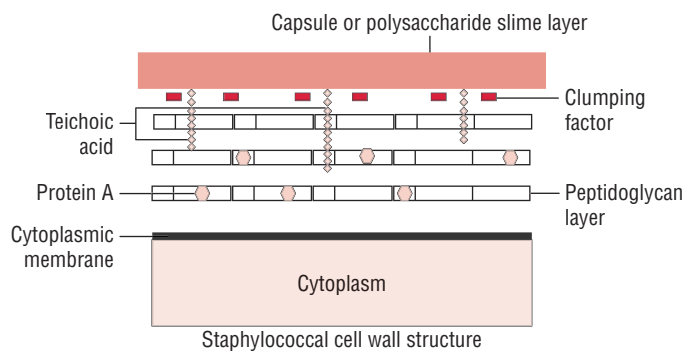

FIG. 23-2. Cell wall structure of *Staphylococcus aureus*.

### ▶ Teichoic acid

Teichoic acid is the major antigenic determinant of the cell wall of *S. aureus*. It is a polymer of ribitol phosphate. Antibodies to teichoic acids develop in endocarditis and in certain other staphylococcal infections.

### ▶ Protein A

It is the major protein in the cell wall and has a molecular weight of 13,000 Da. It is present in large quantities in the cell wall of certain strains of *S. aureus*, such as the Cowan's strain of *S. aureus* (SAPA). This is a group specific antigen. The antigen is present in more than 90% strains of *S. aureus*. Protein A is absent in both the coagulase-negative staphylococci (CONS) and micrococci.

## Pathogenesis and Immunity

*S. aureus* causes disease by multiplying in tissues and causing inflammation, and also by liberating toxin.

### ▶ Virulence factors

*S. aureus* produces several virulence factors (Table 23-3), which include the following:

- (a) Cell wall associated proteins and polymers
- (b) Extracellular enzymes
- (c) Toxins

TABLE 23-3

### Virulence factors of *Staphylococcus aureus*

Virulence factors	Biological functions
<b>Cell wall associated polymers and proteins</b>	
Peptidoglycan	Inhibits chemotaxis of inflammatory cells
Capsular polysaccharide	Inhibits phagocytosis and chemotaxis
Teichoic acid	Mediates attachment of staphylococci to mucosal cell
Protein A	Chemotactic, anticomplementary, and antiphagocytic; causes platelet injury; and elicits hypersensitivity reactions
<b>Enzymes</b>	
Coagulase	The enzyme coats the bacterial cells with fibrin, rendering them resistant to opsonization and phagocytosis
Catalase	Produces nascent oxygen which causes oxidative damage to host tissue
Hyaluronidase	Hydrolyzes hyaluronic acids present in the matrix of the connective tissues, thereby facilitating the spread of bacteria in the tissues
Penicillinase	Inactivates penicillins
Nuclease	Hydrolyzes DNA
Lipases	Hydrolyzes lipids
<b>Toxins</b>	
Toxic shock syndrome toxin	Superantigen, stimulates the release of large amount of interleukins (IL-1 and IL-2)
Enterotoxin	Superantigen, acts by producing large amounts of interleukins (IL-1 and IL-2)
Exfoliative toxin	Splits intercellular bridges in the stratum granulosum of epidermis of the skin
Leukocidin toxin	Leukolysin is thermostable and causes lysis of leukocytes
Hemolysin	Causes lysis of erythrocytes

### Cell wall associated proteins and polymers

These include capsular polysaccharide, protein A, peptidoglycan, and teichoic acid that contribute to pathogenesis of staphylococcal diseases.

**Capsular polysaccharide:** Few strains of *S. aureus* are capsulated. These strains are more virulent than the noncapsulated ones.

- The capsule protects the bacteria from phagocytosis.
- The capsule also facilitates adherence of the cocci to host cells and to prosthetic implants.

**Protein A:** Protein A is an important virulence factor since it has non-specific interaction with Fc portion of the immunoglobulin G (IgG) leaving the Fab portions free to combine with specific antigen.

- It is chemotactic, anticomplementary, and antiphagocytic.
- It causes platelet injury and elicits hypersensitivity reactions.

**Peptidoglycan:** It activates the complement, stimulates production of the antibodies, and inhibits chemotaxis by inflammatory cells.

**Teichoic acid:** It mediates attachment of staphylococci to mucosal cell.

### Extracellular enzymes

The enzymes include (a) coagulase, (b) catalase, (c) hyaluronidase, (d) penicillinase, and (e) other enzymes.

**Coagulase:** *S. aureus* has a unique ability to clot a variety of mammalian plasma. Clotting of plasma is brought about by the action of the enzyme coagulase secreted by the pathogenic strains of *S. aureus*. The enzyme coagulase is of two types: (a) free coagulase and (b) bound coagulase.

**A. Free coagulase:** Free coagulase is a heat-labile and filterable enzyme. It has eight antigenic types (A, B, C, D, E, F, G, and H). Antigenic type A is produced by most human *S. aureus* strains. The enzyme coagulase in association with coagulase-reacting factor (CRF) present in plasma converts fibrinogen to fibrin. In the absence of CRF, coagulase cannot bring about clotting like in case of the guinea pig plasma. This fibrin coats the bacterial cells, rendering them resistant to opsonization and phagocytosis and hence making bacteria more virulent. All coagulase-producing staphylococci are, by definition, *S. aureus*. Coagulase production is demonstrated by tube coagulase test, which is an important test for the identification of *S. aureus*.

**B. Bound coagulase:** Bound coagulase is otherwise known as clumping factor. It is a heat-stable protein and is present in the cell wall. This enzyme brings about clumping of the staphylococci when mixed with plasma by directly acting on fibrinogen. Lysis of the cell releases the enzyme. Unlike free coagulase, clumping factor does not need CRF for its action; till date only one type has been identified. Bound coagulase is not a virulence factor.

Differences between coagulase and clumping factors are summarized in Table 23-4.

TABLE 23-4

### Differentiating features of coagulase and clumping factors

Coagulase	Clumping factor
Produced extracellularly	Present on the surface
Detected by tube test	Detected by slide test
Heat labile	Heat stable
Eight serotypes	One serotype
Needs CRF	Does not need CRF
Is a virulence factor	Is not a virulence factor

**Catalase:** The enzyme catalase reduces  $H_2O_2$  to nascent oxygen and water. This nascent oxygen causes oxidative damage of host tissue. This enzyme is produced after phagocytosis or during metabolism of the bacteria. All strains of staphylococci produce catalase unlike streptococci.

**Hyaluronidase:** The enzyme hyaluronidase hydrolyzes the acidic mucopolysaccharides present in the matrix of the connective tissues, thereby facilitating the spread of bacteria in tissues.

**Penicillinase:** More than 90% of *S. aureus* produce enzyme penicillinase. The enzyme inactivates penicillin group of antibiotics, hence is responsible for widespread occurrence of penicillin-resistant staphylococci. The gene for this enzyme is acquired through plasmids.

**Other enzymes:** These include phosphatase, deoxyribonucleases, nucleases, proteases, phospholipase, and lipases.

### Toxins

Toxins include (a) toxic shock syndrome toxin, (b) enterotoxin, (c) exfoliative toxin, (d) leukocidins, and (e) hemolysins.

**Toxic shock syndrome toxin:** Toxic shock syndrome toxin (TSST) is a protein with a molecular weight of 22,000 Da and resembles enterotoxin F and exotoxin C. It is antigenic. Production of toxin is pH dependent and occurs at pH 7–8. The toxin causes toxic shock syndrome (TSS).

- *S. aureus* strains responsible for menstruation-associated TSS and half of the strains responsible for non-menstruation associated TSS produce TSST-1. The strains producing TSST-1 belong to the bacteriophage group I.
- TSST is a superantigen and hence a potent stimulant of T lymphocytes, resulting in release of large amount of interleukins (IL-1 and IL-2) and tumor necrosis factor, ultimately manifesting in TSS.

**Enterotoxin:** Enterotoxin is a heat-stable protein, capable of resisting boiling for about 30 minutes. It is also gut-enzyme resistant. The toxin is produced by nearly one-third of all the strains of *S. aureus*, and these strains belong to bacteriophage group III (6/47).

Nine antigenic types (A, B, C<sub>1,2,&3</sub>, D, E, G, H, I, and J) of enterotoxins have been described, out of which type A and B are most important. These proteins are of molecular weights ranging from 26,000 to 30,000 Da.



- The toxins are superantigens and act by producing large amounts of interleukins, IL-1 and IL-2.
- The enterotoxins are responsible for clinical conditions like staphylococcal food poisoning and pseudomembranous enterocolitis postantibiotic therapy.

**Exfoliative toxin:** Exfoliative toxin is of two types: (a) toxin A (molecular weight of 30,000 Da) and (b) toxin B (molecular weight of 29,500 Da). Toxin A is heat stable, while toxin B is heat labile. The toxin is antigenic, and specific antibodies against the toxin are protective. The strains producing this toxin belong to bacteriophage group II.

- The toxin breaks intercellular bridges in the stratum granulosum of epidermis and causes its separation from the underlying tissue, resulting in a blistering and exfoliating disease of the skin.
- Toxin in localized form causes bullous impetigo and in generalized form causes staphylococcal scalded skin syndrome (SSSS) in children below 4 years of age.

**Leukocidins:** Leukocidins include (a) alpha-lysin, (b) Panton-Valentine-leukocidin (PV-leukocidin), and (c) leukolysin.

- The alpha-lysin is the most important leukocidin. It causes marked necrosis of the skin and hemolysis by damaging the cell membrane, leading to release of low-molecular-weight substances from the damaged cells.
- PV-leukocidins are six in number, each consisting of two components. The molecular weight is around 32 kDa. These toxins cause death of human leukocytes and macrophages without causing any lysis.
- Leukolysin is thermostable and causes lysis of leukocytes and necrosis of tissues *in vivo*.

**Hemolysins:** *S. aureus* produces four hemolysins: alpha ( $\alpha$ ), beta ( $\beta$ ), gamma ( $\gamma$ ), and delta ( $\delta$ ) hemolysins.

- Alpha-hemolysin is a protein with a molecular weight of 33 kDa. It has lethal effects on a wide variety of cell types and lyses erythrocytes of several animal species.
- Beta-hemolysin is a sphingomyelinase that is active on a variety of cells. It is a protein with a molecular weight of 35 kDa. It is a hot-cold hemolysin; i.e., its hemolytic properties are increased by exposure of the RBCs to cold temperature.
- Delta-hemolysin is a protein with a molecular weight of 8 kDa. It acts primarily as a surfactant.
- Gamma-hemolysin actually consists of three proteins. The three delta-hemolysin proteins interact with one of the two PV-leukocidin proteins.

### ► Pathogenesis of staphylococcal infections

*S. aureus* are pyogenic bacteria that cause localized lesions in contrast to streptococci that are spreading in nature. Staphylococci adhere to the damaged skin, mucosa, or tissue surfaces. At these sites, they evade defense mechanisms of the host, colonize, and cause tissue damage. They produce disease by:

- Multiplying in tissues,
- Liberating toxins, and
- Stimulating inflammation.

### ► Host immunity

*S. aureus* infection does not cause any life-long immunity. It causes repeated infections in a susceptible host.

## Clinical Syndromes

The diseases caused by *S. aureus* can be divided into two groups: (a) inflammatory and (b) toxin-mediated staphylococcal diseases.

### ► Inflammatory staphylococcal diseases

These include the following conditions:

- Staphylococcal skin infections include impetigo, folliculitis, furuncles, carbuncles, paronychia, surgical wound infection, blepharitis, and postpartum breast infection.
- *S. aureus* is the most common cause of boils. The infection is acquired either by self-inoculation from a carrier site, such as the nose or through contact with another person harboring the bacteria.
- Bacteremia and septicemia may occur from any localized lesion, especially wound infection or as a result of intravenous drug abuse.
- *S. aureus* is an important cause of acute bacterial endocarditis, of normal or prosthetic heart valves, which is associated with high mortality.
- *S. aureus* is the most common cause of osteomyelitis in children. The bacteria reach bone through blood stream or by direct implantation following trauma.
- *S. aureus* causes pneumonia in postoperative patients following viral respiratory infection, leading to empyema; it also leads to chronic sinusitis.
- *S. aureus* causes deep-seated abscesses in any organ after bacteremia.

### ► Toxin-mediated staphylococcal diseases

These include (a) staphylococcal food poisoning, (b) staphylococcal toxic shock syndrome, and (c) staphylococcal scalded skin syndrome.

**Staphylococcal food poisoning:** Staphylococcal food poisoning is caused by enterotoxin. The enterotoxin is a preformed toxin, already present in the contaminated food before consumption. Milk and milk products and animal products like fish and meat kept at room temperature after cooking are mainly incriminated. When kept at room temperature, the contaminating staphylococci multiply and produce toxin adequate enough (as little as 25  $\mu$ g of toxin B can lead to illness) to cause food poisoning.

The toxin acts by stimulating the release of large amounts of interleukins IL-1 and IL-2. It is fairly heat resistant and so is not inactivated by brief cooking.

Often a food handler, who either is a carrier of *S. aureus* (nose, skin) or is suffering from staphylococcal skin infection,

is the source of infection. The onset of symptoms is sudden, appearing within 2–6 hours of ingestion of food. It is a self-limiting condition characterized by nausea, vomiting, abdominal cramps, and watery, nonbloody diarrhea.

**Staphylococcal toxic shock syndrome:** Staphylococcal toxic shock syndrome (STSS) is caused by TSST. The toxin is a superantigen, which causes STSS by stimulating the release of large amounts of interleukins IL-1 and IL-2 in the body.

The STSS is an acute and potentially life-threatening condition similar to Gram-negative sepsis and septic shock. STSS is a multisystem disease characterized by fever, hypotension, myalgia, vomiting, diarrhea, mucosal hyperemia, and an erythematous rash followed by desquamation of the skin, particularly on palms and soles.

This condition was first documented in 1980 in the United States among the menstruating women who used highly absorbent vaginal tampons; the vaginal swab from these women showed a heavy growth of *S. aureus*. This condition can also occur in other individuals, who have a local site of staphylococcal infection on skin or mucosa or on any other extragenital site.

**Staphylococcal scalded skin syndrome:** Staphylococcal scalded skin syndrome (SSSS) is caused by the exfoliative toxin, exfoliatin. The condition is seen commonly in infants and children. It is associated with extensive exfoliation of the skin, in which outer layer of the epidermis is separated from the underlying tissue and is characterized by the appearance of extensive bullae. These bullae when ruptured may leave behind scalded, red, tender skin. The lesion typically starts periorificially or in skin folds. It usually resolves within 10 days' time.

Pemphigus neonatorum and bullous impetigo are the milder forms, whereas Ritter's disease in the newborn and toxic epidermal necrolysis in the older persons are the severe forms of the SSSS.

## Complications of Staphylococcal Diseases

Complications of staphylococcal diseases include bacterial pneumonia, septicemia, arthritis, meningitis, etc. These complications are frequently seen in persons with extreme of age, debilitated persons, and immunosuppressed hosts.

## Epidemiology

### ► Geographical distribution

Staphylococcal infections are found throughout the world. Nearly one-third of the adult population is asymptomatic carrier of staphylococci. Hospital infections caused by *S. aureus* are worldwide in distribution.

### ► Habitat

Staphylococci are primary pathogens of humans and animals. They are present as commensals on skin, in the glands of the skin, and on mucous membranes. The cocci are commonly found in the intertriginous skin folds, perineum, axillae, and vagina. Approximately, 35–50% of normal adults carry *S. aureus* in the anterior nares, 10% in the perineum, and 5–10% in the vagina.

### ► Reservoir, source, and transmission of infection

Human cases and carriers are the important reservoir of infection.

- Human cases of cutaneous and respiratory infections shed large numbers of staphylococci into the environment for a prolonged period of time. Staphylococci colonize the skin very early in life (in neonates on the umbilical stump).
- Staphylococci shed by the patients and carriers contaminate handkerchiefs, bed linens, blankets, and other inanimate fomites and persist in them for weeks.
- *S. aureus* found in the nose and sometimes on the skin, especially in hospital staff and patients is the main source of infection in hospitals.
- Domestic animals, such as cows, can also be reservoirs of staphylococcal infection.

## Key Points

Staphylococcal infections may be acquired through:

- Self-inoculation from nose or other sites in patients who harbor staphylococci (*endogenous infection*) or
- Direct contact with infected humans, carriers, and less frequently, animals (*exogenous infection*). Exogenous infection can also be acquired by close contact with infected fomites or inhalation of air droplets in heavily contaminated environment.

**Hospital-acquired *S. aureus* infections:** This is the most common cause of hospital-acquired infections. Certain strains of *S. aureus* causing hospital infections are known as **hospital strains**. They exhibit certain properties, which are presented in Box 23-1.

### ► Bacteriophage typing

Strains of staphylococci can be typed by bacteriophage typing, which is useful in epidemiological studies (Fig. 23-3). Bacteriophage typing is based on the susceptibility of cocci to bacteriophages. This is carried out by pattern method, where a set of 23 standard typing phages of *S. aureus* is used to type staphylococcal isolates and distinguish them from one another by their patterns of susceptibility to lysis. In this method, the

## Box 23-1

### Hospital strains of *Staphylococcus aureus*

Certain strains of staphylococci are the common causes of postoperative wound infections and other infections in the hospital environment. These strains are known as “hospital strains”. These hospital strains show following characteristics:

1. They are usually resistant to penicillin, methicillin, and other routinely used antibiotics.
2. They belong to certain bacteriophage types.
3. Some of the strains (e.g., phage type 80/81) are known to cause hospital infections throughout the world. Such strains are known as “epidemic strains”.

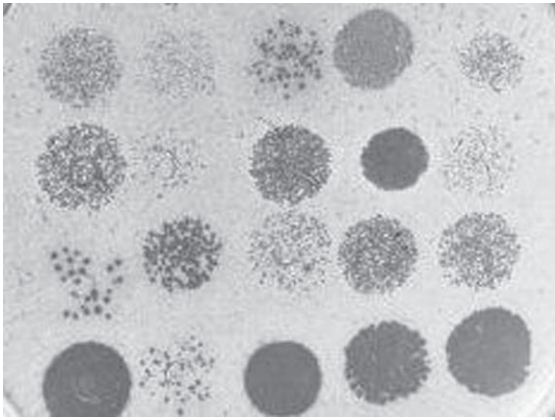

FIG. 23-3. Bacteriophage typing of staphylococci.

TABLE 23-5

**Phage typing of human isolates of *Staphylococcus aureus***

Group	Phage
I	29, 52, 52A, 79, 80
II	3A, 3C, 55, 71
III	6, 42E, 47, 53, 54, 75, 77, 83A, 84, 85
IV	—
V	94, 96
Not allocated	81, 95

strain of *S. aureus* to be typed is inoculated on a nutrient agar plate to produce a lawn culture. After drying the plate, various phages at their routine test dilution (RTD) are applied over marked squares on plate. Such plates are then incubated overnight at 30°C and observed for the presence or absence of lysis of the colonies by the phages.

The phage type of a strain is known by designation of the phages that lyse it. Thus, if a strain is lysed by phages 83A, 84, and 85, it is called phage type 83A/84/85. By this method, most of the strains of staphylococci can be classified and are divided into five lytic groups, while there are a few which cannot be classified and constitute the unclassified group (Table 23-5).

The national reference centre for staphylococcal phage typing in India is located in the Department of Microbiology, Maulana Azad Medical College, New Delhi.

### Other typing methods

*S. aureus* has been classified into six biotypes (A, B, C, D, E, and F). Most human pathogenic strains belong to biotype A. Other typing methods include (a) plasmid profile, (b) DNA fingerprinting, (c) ribotyping, and (d) PCR-based analysis of genetic pleomorphism and (e) serotyping.

## Laboratory Diagnosis

Laboratory diagnosis of staphylococcal infections is based on the demonstration of staphylococci, in appropriate clinical specimens, by microscopy and culture.

### Specimens

Specimens to be collected for demonstration of staphylococci depend on the nature of lesion (Table 23-6).

### Microscopy

Demonstration of Gram-positive cocci arranged in clusters and pus cells in the Gram-stained smears of pus (Fig. 23-4, Color Photo 14), wound exudate, etc. are the characteristic features of pyogenic infection caused by *S. aureus*. It is noteworthy that microscopy:

- Alone is not adequate to differentiate various species of staphylococci or micrococci from one another.
- Is also of no value for sputum and other specimens where mixed bacterial flora is present.

### Culture

The identification of staphylococci is confirmed by culture and other identification tests comprising a range of biochemical and enzymatic tests followed by antibiotic sensitivity. The specimens are inoculated onto nutrient agar and blood agar and incubated at 37°C for 24 hours. On nutrient agar, large, circular, smooth, convex, and glistening colonies showing golden-yellow pigments can be observed. On blood agar, the colonies show a zone of beta-hemolysis, which is not shown by any other species of staphylococci.

Specimens from heavily contaminated sources, such as vomitus and feces, are inoculated on selective media (e.g., mannitol salt agar or salt milk agar). These media inhibit growth of Gram-negative bacteria but allow the growth of staphylococci and certain other Gram-positive cocci.

### Identification of bacteria

The identifying features of *S. aureus* are summarized in Box 23-2.

### Coagulase test

Coagulase test is an important test carried out to detect *S. aureus*. The test is done in two ways: tube coagulase test and slide coagulase test.

TABLE 23-6

**Various specimens collected in staphylococcal infections**

Specimen	Condition
Pus	Suppurative lesions and osteomyelitis
Sputum	Respiratory infections
Blood	Bacteremia
Feces and vomitus	Food poisoning
Urine	Urinary tract infections
Nasal and perineal swab	Suspected carriers

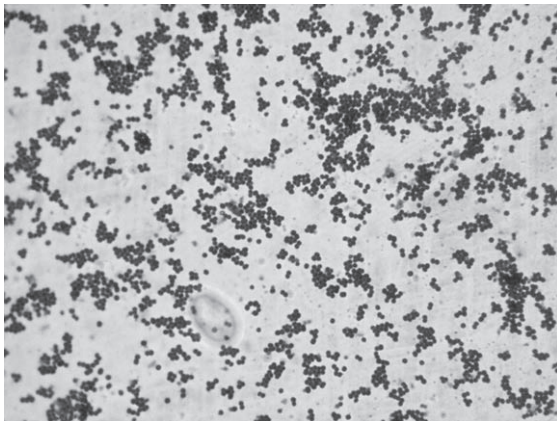

FIG. 23-4. Gram-stained pus smear showing staphylococci ( $\times 1000$ ).

### Box 23-2 Identifying features of *Staphylococcus aureus*

1. *S. aureus* are Gram-positive cocci arranged in irregular grape-like clusters.
2. On nutrient agar, *S. aureus* colonies produce characteristic golden-yellow colonies.
3. On blood agar, *S. aureus* produces a clear zone of hemolysis (*beta*-hemolysis).
4. *S. aureus* are coagulase positive. All coagulase-producing staphylococci are, by definition, *S. aureus*.
5. *S. aureus* are phosphatase positive, DNAase positive, and mannitol positive.
6. *S. aureus* are novobiocin and polymyxin B sensitive.

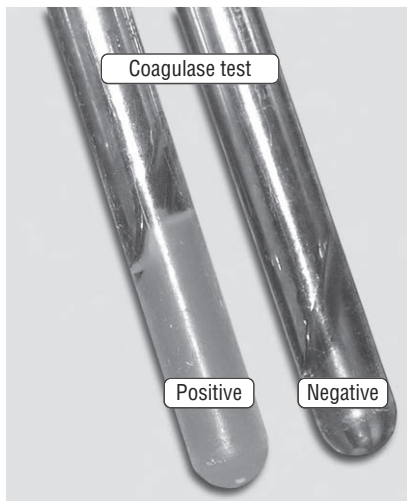

FIG. 23-5. Tube coagulase test.

**Tube coagulase test:** Tube coagulase test is carried out to detect free coagulase. In this test, 0.1 mL of an overnight broth culture is mixed with 0.5 mL of a 1:10 dilution of human or rabbit plasma. The plasma-broth culture mixture is incubated in a water bath at 37°C for 3–6 hours. In a positive test, the plasma is coagulated and does not flow (Fig. 23-5, Color Photo 13).

- Human or rabbit plasma, which is rich in CRF, is used in the test. The plasma is collected in vials containing anticoagulants, such as oxalate, heparin, or EDTA.
- Citrated plasma is not used because if the specimen is contaminated with Gram-negative bacilli, the latter may utilize the citrate and produce false positive reaction.

**Slide coagulase test:** Slide coagulase test detects the bound coagulase or the clumping factor. The test is performed by mixing a dense suspension of the staphylococci with a loopful of undiluted rabbit plasma on a slide. In a positive test, clumping takes place within 10 seconds.

### Phosphatase test

The production of phosphatase can be demonstrated by culturing a mixed specimen on phenolphthalein phosphate agar and exposing the colonies to ammonium vapors. *S. aureus* colonies turn bright pink due to the release of phenolphthalein.

### Novobiocin sensitivity

Novobiocin sensitivity is a simple disk diffusion test to differentiate *S. aureus* from other staphylococci. This test is carried out by using a 5- $\mu$ g novobiocin disk on an overnight culture of staphylococci on Mueller–Hinton agar. Novobiocin sensitivity is shown by an inhibition zone of  $\geq 16$  mm. *S. aureus* is novobiocin sensitive, while *S. saprophyticus* is novobiocin resistant.

### Polymyxin B resistance

Polymyxin B sensitivity is again a simple disk diffusion test to differentiate *S. aureus* from other staphylococci. This is carried out by using a 300-U polymyxin B disk on an overnight culture of staphylococci on Mueller–Hinton agar. Polymyxin resistance is shown by an inhibition zone of  $< 10$  mm. *S. aureus* is usually polymyxin resistant.

### Treatment

Skin and soft tissue infections are treated best with local wound care with or without topical antibiotics (e.g., neomycin). Spontaneous or surgical drainage of pus and debridement of necrotic tissue is an effective mode for treatment of staphylococcal abscess. Systemic antibiotics are necessary for deep-seated and systemic infections.

### Key Points

- Benzyl penicillin is the drug of choice for penicillin-sensitive strains of *S. aureus*.
- Erythromycin, vancomycin, or first-generation cephalosporins are recommended for patients with allergy to penicillin.

### ► Penicillin resistance in staphylococci

Penicillin resistance in the bacteria is increasingly recognized since 1945. Nearly 80% or more strains of *S. aureus* are resistant to penicillin. It is of three types:

**1. Plasmid-mediated resistance:** This type of resistance may be due to the production of enzyme penicillinase (beta-lactamase), which is plasmid mediated. This enzyme inactivates penicillin by splitting the beta-lactam rings. Staphylococci produce four types of penicillinases (A, B, C, and D). Penicillinase plasmids are transmitted to the staphylococci by both transduction and conjugation. The plasmids also carry markers of resistance to heavy metals, such as arsenic, cadmium, mercury, lead, and bismuth as well as to other antibiotics, such as erythromycin and fusidic acid.

**2. Chromosomal-mediated resistance:** This type of resistance has also been documented. Reduction in the affinity of the penicillin-binding proteins (PBPs; present on the cell wall of the staphylococci) to the beta-lactam antibiotics also contributes to the resistance of the bacteria to penicillins and other beta-lactam antibiotics.

**3. Tolerance to penicillin:** Staphylococci developing tolerance to penicillin are only inhibited but not killed. Penicillin-resistant strains can be treated with beta-lactamase-resistant penicillins, e.g., oxacillin, flucloxacillin, cloxacillin, methicillin, or vancomycin.

### ► Methicillin-resistant staphylococci

Methicillin-resistant *S. aureus* (MRSA) denotes resistance of *S. aureus* to penicillin, as well as to all other beta-lactam antibiotics including the third-generation cephalosporins and carbapenems. Resistance to methicillin is due to the production of a novel PBP, designated as PBP 2a. PBPs are the targets of beta-lactam antibiotics.

Infections caused by MRSA are being increasingly reported worldwide since 1980. The infection is also being increasingly reported now, from different hospitals. MRSA usually colonizes the broken skin and can cause a wide range of local and systemic staphylococcal infections.

Hospital staffs harboring MRSA are the chief source of infection for the patients. These strains can cause a wide range of infections including bacteremia, endocarditis, and pneumonia. These strains are increasingly recognized as important agents of hospital-acquired infection in hospitalized patients undergoing prosthetic heart valve surgery.

MRSA strains can be treated with glycopeptide antibiotics, such as vancomycin and teicoplanin in serious systemic infections, such as pneumonia, bacteremia, and endocarditis. MRSA are sensitive to one or more of the second-line drugs, which include erythromycin, clindamycin, quinolones, fusidic acid, trimethoprim, chloramphenicol, tetracycline, and rifampicin. However, ciprofloxacin, rifampicin, and fusidic acid are not used simply because of the possibility of emergence of resistance.

Proper hand-washing and use of topical agents, such as mupirocin and chlorhexidine on skin and nose to eradicate the agents are effective to prevent and control nosocomial infections caused by MRSA.

### Prevention and Control

There is no effective immunization with toxoids or bacterial vaccines against staphylococcal infection. Cleanliness, frequent hand-washing, and aseptic management of lesions help in the

control of *S. aureus* infection. Treating with nasal creams containing neomycin or bacitracin prevents recurrent infections in cases of nasal carriers of *S. aureus*. Topical application of antimicrobial agents prevents dissemination of infection from the abscesses.

### Coagulase-Negative Staphylococci

Coagulase-negative staphylococci (CONS) are the normal flora of the skin. CONS are opportunistic bacteria. They cause infections in debilitated or immunocompromised patients and in patients fitted with urinary catheters, cardiac valves, pacemakers, and artificial joints.

- They form white nonpigmented colonies, morphologically similar to those of *S. aureus*.
- They are differentiated from *S. aureus* by their failure to coagulate the plasma due to the absence of the enzyme coagulase.

CONS of medical importance include (a) *S. epidermidis*, (b) *S. saprophyticus*, (c) *S. haemolyticus*, (d) *S. saccharolyticus*, (e) *S. hominis*, (f) *S. schleiferi*, (g) *S. lugdunensis*, and (h) *Staphylococcus simulans*.

### *Staphylococcus epidermidis*

*S. epidermidis* forms white colonies on blood agar. It is catalase positive, coagulase negative, and does not ferment mannitol. It tolerates salt, survives drying, and is highly antibiotic resistant. It is a normal skin commensal. Carriage rate is as high as 100%. This bacterium is transmitted by self-inoculation or by contact with infected patients and hospital personnel.

Ability to produce slime is an important virulence factor of the bacterium. *S. epidermidis* causes infection by adhering itself to the surface of the intravenous plastic catheters and prosthetic devices. The adherence is believed to be facilitated by polysaccharide glycocalyx known as slime, produced in large quantities by the bacteria. Slime also inhibits the action of lymphocytes and neutrophils. *S. epidermidis* is an important agent of hospital-acquired infection. It causes:

- infection in compromised hosts, such as neutropenic patients, particularly in association with intravenous catheters and other prosthetic devices, such as heart valves.
- endocarditis in patients with prosthetic valves, intravenous catheter infections, CSF shunt infections, catheter-associated peritonitis and endocarditis.
- sepsis in neonates, osteomyelitis, wound infections, vascular graft infections, and mediastinitis.

Vancomycin is the drug of choice for treatment of infection caused by *S. epidermidis*.

### *Staphylococcus saprophyticus*

*S. saprophyticus* forms white colonies on blood agar. It is catalase positive, coagulase negative, and does not ferment mannitol. It normally inhabits the skin and genital mucosa. The bacterium causes:

TABLE 23-7

**Differences between *Staphylococcus aureus*, *Staphylococcus epidermidis*, and *Staphylococcus saprophyticus***

Test	<i>S. aureus</i>	<i>S. epidermidis</i>	<i>S. saprophyticus</i>
Coagulase	+	–	–
Clumping factor	+	–	–
Heat-stable nuclease	+	–	–
Urease	Variable	–	+
$\beta$ -galactosidase	–	–	+
Alkaline phosphatase	+	+	–
Polymyxin B	Resistant	Resistant	Sensitive
Novobiocin	Sensitive	Sensitive	Resistant
Acid from mannitol	+	–	–
Acid from trehalose	+	–	–
Acid from mannose	+	+	–
PYR test	–	–	+

- Urinary tract infection by endogenous spread in colonized women. It adheres to the epithelial cells lining the urogenital tract. It causes dysuria, pyuria, and hematuria.
- Urethritis, catheter-associated urinary tract infections, prostatitis in elderly men, and rarely, sepsis and endocarditis.

Urinary tract infection caused by *S. saprophyticus* can be treated with quinolones (such as norfloxacin) or with trimethoprim–sulfamethoxazole.

*S. epidermidis* and *S. saprophyticus* are distinguished from each other by their reaction to antibiotic novobiocin—*S. epidermidis* is sensitive, while *S. saprophyticus* is resistant. The differences between *S. aureus*, *S. epidermidis*, and *S. saprophyticus* are summarized in Table 23-7.

**Other Coagulase-Negative Staphylococci**

There are many other coagulase-negative staphylococci that have been reported recently to cause human infections. These include the following:

1. *S. haemolyticus* causes bacteremia, endocarditis, urinary tract infection, and wound infection.
2. *S. saccharolyticus* causes endocarditis.
3. *S. hominis* causes bacteremia in cancer patients.
4. *S. schleiferi* causes wound infections, bacteremia, and indwelling catheter infections.
5. *S. lugdunensis* causes endocarditis, peritonitis, osteomyelitis, and breast abscesses.
6. *S. simulans* causes septicemia, osteomyelitis, and septic arthritis.

**Micrococcus**

Micrococci in comparison to staphylococci are larger and measure up to 2  $\mu\text{m}$  in diameter. In smears, they appear as Gram-positive cocci arranged in tetrads. On culture, they produce colonies with yellow, pink, or red pigments. It is doubtful that they are human pathogens.

**Planococcus**

They are Gram-positive cocci most commonly found in seawater, prawns, and shrimp. They are distinguished from other Gram-positive cocci by their ability to grow in a higher salt concentration of 12% sodium chloride. They are nonpathogenic to humans.

**Stomatococcus**

They are capsulated Gram-positive cocci arranged in pairs or clusters. On culture, they produce white and mucoid colonies. It is doubtful that they are human pathogens.

**CASE STUDY**

A group of 25 students of 11–12 years of age studying in a higher secondary school in Haripur were admitted to a hospital with complaints of severe vomiting and diarrhea within 3 hours of consuming the food prepared in their school. History revealed that a new cook appointed a few days back in the school prepared the food. All the students consumed the same food. Children were treated and were discharged after observing them overnight in the hospital.

- What is the possible cause of this food poisoning?
- What is the possible reservoir for this organism that was responsible for this outbreak?
- What are the tests you will perform to establish the etiological diagnosis of the condition?
- What steps you will take to prevent this infection?

# Streptococcus and Enterococcus

## Introduction

Streptococci are aerobic and facultatively anaerobic Gram-positive cocci, arranged in pairs, or chains. The enterococci are facultative anaerobes. They require complex nutrients for their growth. Streptococci and enterococci causing human infections are summarized in Table 24-1.

## Streptococcus

Streptococci are part of the normal flora in humans and animals.

- They are nonmotile, nonsporing, spherical or ovoid cocci, and have hyaluronic acid capsules.
- They are catalase negative by which they are distinguished from staphylococci.
- They are relatively fastidious bacteria requiring enriched medium, such as blood agar for their growth.

## Classification

The streptococci based on their oxygen requirement are classified into aerobes and obligate anaerobes. Obligate anaerobes are designated as peptostreptococci, which will be described in detail in Chapter 30. The aerobes and facultative anaerobes are further classified as follows:

### ► Classification based on hemolysis in blood agar

The aerobes and facultative anaerobes are further classified on the basis of their hemolytic properties on blood

agar. Brown (1919) classified these aerobic streptococci into three groups on the basis of their growth in 5% horse blood agar.

**Alpha-hemolytic streptococci:** These cocci produce colonies surrounded by a narrow zone (greenish zone) of hemolysis with persistence of some partially lysed RBCs. The greenish discoloration is due to the formation of a reduced product of hemoglobin. Alpha-hemolytic streptococci are known as viridans streptococci. These are found as commensals in the upper respiratory tract of humans, and these may cause opportunistic infections. *Streptococcus salivarius* is an important opportunistic pathogen belonging to this group (*Streptococcus pneumoniae* also belongs to alpha-hemolytic group).

**Beta-hemolytic streptococci:** These cocci produce a well-defined, clear, colorless zone of hemolysis (2–4 mm wide) around the colonies. RBCs in the zone of hemolysis are completely lysed. This lysis is due to the liberation of enzymes streptolysin O (SLO) and streptolysin S (SLS). The term hemolytic streptococci is applicable only to beta-hemolytic streptococci. Most of the pathogenic streptococci belong to this group, and among them *Streptococcus pyogenes* is the most important one.

**Gamma-hemolytic streptococci:** These streptococci do not produce any hemolysis or discoloration on blood agar. These nonhemolytic streptococci are generally found as commensals. *Streptococcus faecalis* (*Enterococcus faecalis*) belongs to this group.

### ► Classification based on antigenic structure

Lancefield classification is a serological classification of the beta-hemolytic streptococci. This serological classification is

TABLE 24-1

Human infections caused by *Streptococcus* and *Enterococcus*

Bacteria	Diseases
<i>Streptococcus pyogenes</i>	Pharyngitis, pyoderma (impetigo, erysipelas, cellulites), necrotizing fasciitis, scarlet fever, streptococcal toxic shock syndrome, acute glomerulonephritis (AGN), and acute rheumatic fever
<i>Streptococcus agalactiae</i>	Neonatal infections (septicemia, meningitis, or pneumonia); urinary tract infection in pregnant women; osteomyelitis, arthritis, peritonitis, and skin infections in nonpregnant women and in men
Other hemolytic streptococci	Pharyngitis, bacteremia, abscess formation
Viridans streptococci	Dental caries, subacute endocarditis, and intra-abdominal suppurative infections
<i>Enterococcus</i>	Urinary tract infection especially in hospitalized patients; bacteremia, infection of the bile duct, and endocarditis

based on the detection of group-specific carbohydrate antigen (C antigen) on the cell wall of the streptococci.

The beta-hemolytic streptococci are classified into 21 serological groups known as Lancefield groups, designated from A to W (with exception of I and J). The majority of hemolytic streptococci that cause human infections belong to group A. Group A streptococci are also known as *S. pyogenes*, while group B streptococci are known as *Streptococcus agalactiae*.

Based on the M, T, and R protein antigens present on the cell surface, *S. pyogenes* have been further classified into 80 serotypes. This classification is known as Griffith typing. M protein is the most important type-specific antigen. This serotyping is important for epidemiological studies.

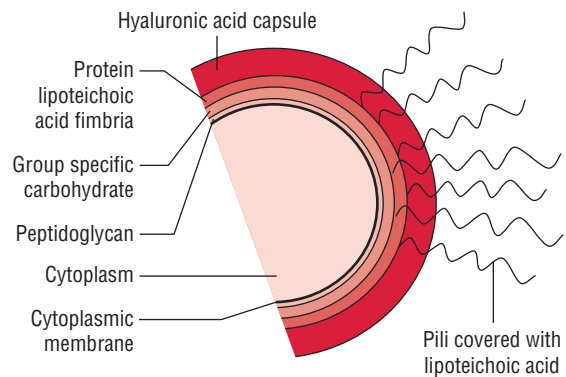

FIG. 24-1. Antigenic structure of *Streptococcus pyogenes*.

## Streptococcus pyogenes

*S. pyogenes* is the species classified under group A streptococci. It is the most important human pathogen causing:

1. Pyogenic infections, such as bacterial pharyngitis and cellulitis.
2. Toxin-mediated diseases, such as scarlet fever and toxic shock syndrome.
3. Immunologic diseases, such as acute glomerulonephritis (AGN) and rheumatic fever.

## Properties of the Bacteria

### ► Morphology

*S. pyogenes* shows following features:

- They are Gram-positive cocci measuring 0.6–1.0  $\mu\text{m}$  in diameter and are arranged in long chains. Streptococci are nonmotile and nonsporing. Streptococci divide in one plane and thus occur in pairs or in chains of varying lengths, especially in liquid media and clinical specimens.
- They are motile and nonsporing.
- Some strains of *S. pyogenes* and some strains of group C streptococci produce capsule during the first 2–4 hours of growth. The capsule is composed of hyaluronic acid containing repeating molecules of glucuronic acid and *N*-acetylglucosamine. It is chemically similar to that of host connective tissue and is therefore nonantigenic. Capsulated strains produce mucoid colonies on the blood agar (Fig. 24-1).

### ► Culture

*S. pyogenes* is an aerobe and facultative anaerobe. It grows at 37°C and at a pH of 7.2–7.4 on enriched medium, such as blood agar.

1. **Blood agar:** *S. pyogenes* produces small white to gray colonies, measuring 0.5–1 mm in diameter with a clear zone

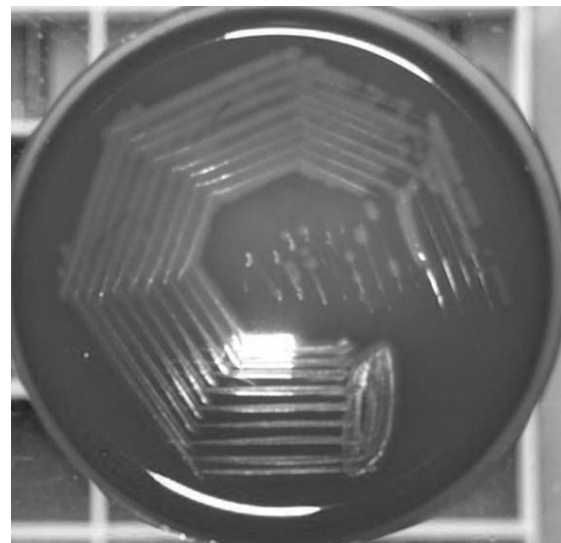

FIG. 24-2. Blood agar plate showing beta-hemolysis surrounding the colonies of *Streptococcus pyogenes*.

of beta-hemolysis (Fig. 24-2, Color Photo 15). Presence of 10%  $\text{CO}_2$  enhances the growth and hemolysis of colonies. The virulent strains on fresh isolation produce matt colonies, while avirulent strains produce glossy colonies. Colonies that produce large amounts of hyaluronic acid appear mucoid on the culture plate.

2. **Selective media:** Crystal violet blood agar is a selective medium for culture of *S. pyogenes*. Addition of 0.0001% crystal violet to blood agar makes the medium highly selective for *S. pyogenes*. This inhibits all other Gram-positive cocci while allowing selective growth of *S. pyogenes*. PNF medium (horse blood agar containing polymyxin B sulfate, neomycin sulfate, and fusidic acid) is another selective medium used for isolation of *S. pyogenes*.
3. **Transport medium:** Pikes transport medium containing (1:1,000,000) crystal violet and (1:16,000) sodium azide is a frequently used transport medium for transporting throat swab for culture of *S. pyogenes*.



4. **Liquid medium:** *S. pyogenes* produces granular turbidity with powdery deposit when grown in the liquid media, such as serum or glucose broth.

### ► Biochemical reactions

*S. pyogenes* shows following biochemical reactions:

- The bacteria are catalase negative; by this property, they are distinguished from staphylococci.
- They ferment many sugars, producing acid but no gas; however, these are of little diagnostic value in the identification of cocci. They do not ferment ribose
- They are not soluble in bile.
- They cause hydrolysis of pyrrolidonyl naphthylamide (PYR).

### ► Other properties

**Susceptibility to physical and chemical agents:** Streptococci are killed by heating at 54°C for 30 minutes and by usual strengths of disinfectants. They are sensitive to bacitracin. Sensitivity to bacitracin is an important diagnostic feature by which *S. pyogenes* can be differentiated from other hemolytic streptococci. They are resistant to crystal violet.

## Cell Wall Components and Antigenic Structure

The cell wall of *S. pyogenes* consists of the following components (Fig. 24-1):

### ► Group-specific carbohydrate

The cell wall contains a group-specific polysaccharide that forms approximately 10% of the dry weight of the cell. It is a polymer of *N*-acetylglucosamine and rhamnose. It is nontoxic and haptens in rabbits. On the basis of group-specific carbohydrate (C) antigen, *S. pyogenes* strains have been divided into 21 groups (A–W) except I and J by Lancefield, hence are known as Lancefield groups. The “C” antigen can be extracted by the following methods:

- Acid extraction with hydrochloric acid (**Lancefield method**),
- Formamide extraction at 150°C (**Fuller’s method**),
- Autoclaving (**Rantz and Randall’s method**), and
- Enzyme extraction (**Maxted’s method**).

After the extraction, the carbohydrate component is treated with type-specific antiserum by a precipitation reaction or by immunofluorescence for grouping of the isolates of *S. pyogenes*.

### ► Type-specific proteins

The cell wall of *S. pyogenes* has three major proteins, M, T, and R proteins. These proteins are useful for serologic typing (Griffith typing) of *S. pyogenes*.

**M protein:** M protein is the most important protein. It is acid- and heat-stable and trypsin-sensitive. It is the chief virulence factor of the cocci. It inhibits phagocytosis and facilitates the attachment of cocci to epithelial cells. M protein, a complex alpha-helix, consists of carboxyl terminus and an amino terminus. The carboxyl terminus is bound to the cytoplasmic membrane and is a highly conserved structure. The amino terminus is present through the cell wall to the cell surface and is highly variable. This variable component is responsible for antigenic differences in the M protein and based on that *S. pyogenes* is divided into more than 80 (I–60) serotypes. M proteins are further subdivided into class I and class II protein molecules:

- Antibodies develop against the exposed constant (C) region of the class I M proteins and are responsible for the pathogenesis of rheumatic fever.
- In contrast, antibodies do not develop against class II M proteins.

**T proteins:** These are trypsin-resistant (T) proteins and are acid and heat labile. T typing of strains of *S. pyogenes* is useful in the epidemiological surveillance of the infection caused by cocci.

**R proteins:** These are pepsin sensitive but trypsin resistant. These proteins are not important for typing the strains.

### ► Other cell surface components

Peptidoglycan, lipoteichoic acid, and F proteins are other components of the cell wall of *S. pyogenes*. Peptidoglycan confers rigidity to the cell wall. It is also responsible for producing fever, dermal and cardiac necrosis in animals, and lysis of erythrocytes.

## Pathogenesis and Immunity

Streptococci have more than 20 soluble antigens, enzymes, and toxins that contribute in the pathogenesis of various stages of streptococcal diseases.

### ► Virulence factors

Streptococci produce a wide range of virulence factors responsible for the disease, which include the following (Table 24-2):

- (a) Cell wall associated proteins and polymers
- (b) Enzymes
- (c) Toxins

### Cell wall associated proteins and polymers

These include capsule, teichoic acid, M protein, and F protein that contribute to pathogenesis of diseases in various ways as mentioned in Table 24-2.

**Capsule:** The cell wall of the *Streptococcus* is surrounded by a capsule. The capsule is nonantigenic and weakly antiphagocytic. It acts like a barrier between the complement proteins bound to the bacteria and the phagocytic cells, thereby preventing phagocytosis of the bacteria. Capsulated strains that are rich in M proteins are highly pathogenic.

TABLE 24-2

Virulence factors of *Streptococcus pyogenes*

Virulence factors	Biological functions
<b>Cell wall associated polymers and proteins</b>	
Capsule	Prevents phagocytosis
Teichoic acid	Binds to epithelial cells
M protein	Adhesin and antiphagocytic; inactivates C3b—an important complement factor responsible for phagocytosis. Strains that are rich in M protein are resistant to phagocytosis and intracellular killing by PMNs. Interferes with opsonisation via the alternative complement pathway
F protein	Mediates attachment to epithelial cells
<b>Enzymes</b>	
Streptokinase	Breaks down the fibrin barrier around the infected site, thereby facilitating spread of the infection
Deoxyribonucleases	Depolymerizes free DNA present in the pus
Hyaluronidase	Hydrolyzes hyaluronic acids in the matrix of the connective tissues
<b>Toxins</b>	
Streptococcal pyrogenic exotoxins (SPEs)	Dissolves the clot, thrombi, and emboli; thereby facilitates spread of the bacteria in tissues
Streptolysin O and Streptolysin S	Lyse erythrocytes, leukocytes, and platelets; and stimulate production of lysosomal enzymes
Pyrogenic exotoxins	Release large amounts of cytokines from helper T cells and macrophages; rapidly destroy tissues

**Teichoic acid, M protein, and F protein:** Lipoteichoic acid and F proteins mediate the binding of the cocci with fibronectin present on the host cell surface. M protein is an adhesin and antiphagocytic, which inactivates C3b—an important complement factor responsible for phagocytosis.

### Enzymes

**Streptokinase:** This enzyme is produced by *S. pyogenes* as well as by group C and G streptococci. Two types of streptokinase have been described—streptokinase A and B. Streptokinase activates plasminogen to form plasmin, which breaks down the fibrin barrier around the infected site, thereby facilitating the spread of the infection. This thrombolytic property is made good use of in medical management of myocardial infarction. Antibodies appear against streptokinase (A and B) during the course of infection and are diagnostic.

**Deoxyribonucleases:** Four types of deoxyribonucleases have been described—deoxyribonucleases A, B, C, and D. Most strains of *S. pyogenes* produce these enzymes. The enzyme depolymerizes free DNA present in the pus, thereby reduces viscosity of pus and helps in spread of the infection. The enzymes are antigenic, and the demonstration of antideoxyribonuclease B antibody in serum is diagnostic of *S. pyogenes* infections, particularly of skin infections.

**Hyaluronidase:** The enzyme is produced by *S. pyogenes* as well as by other groups like B, C, G streptococci, *Streptococcus suis*, *Streptococcus anginosus*, and *S. pneumoniae*. The enzyme splits hyaluronic acid present in host connective tissue, thereby facilitating spread of the bacteria through tissues. The enzyme is antigenic.

**Serum opacity factor:** This is a lipoproteinase produced by some M types of *S. pyogenes*. This enzyme produces opacity when applied to agar gel containing swine or horse serum, hence is known as serum opacity factor (SOP). SOP is antigenic.

**Other enzymes:** These include neuraminidase, amylase, esterase, lipase, and beta-glucuronidase.

### Toxins

**Streptococcal pyrogenic exotoxins (SPEs):** Streptococcal pyrogenic exotoxin, otherwise called erythrogenic toxins, are of three types: Spe A, Spe B, and Spe C.

- These toxins are antigenic, and their production is regulated by a temperate phage in their genome.
- These toxins act as superantigen and are responsible for scarlet fever and streptococcal toxic shock syndrome.

**Dick test:** The susceptibility of a person to these toxins is determined by performing a skin test known as Dick test. In this test, 0.2 mL of the diluted toxin is injected intradermally. In a positive test, a localized erythematous reaction, around 1 cm in diameter, develops within 12–24 hours. A positive test indicates absence of antibodies against the toxin and shows susceptibility to the toxin and thus to scarlet fever. No reaction takes place in a negative test, which indicates the presence of specific antibodies against erythrogenic toxin in the serum.

**Schultz Charlton test:** Intradermal injection of antitoxin in a patient with scarlet fever causes local blanching of the rash. This is due to neutralization of erythrogenic toxin. This test is known as Schultz Charlton test.

**Hemolysins:** Two types of hemolysins, oxygen-labile streptolysin O (SLO) and oxygen-stable and serum-soluble streptolysin S (SLS), are produced by *S. pyogenes*.

**Streptolysin O:** SLO is an oxygen-labile and heat-labile protein with a molecular weight of 50,000–75,000 Da. It causes beta-hemolysis only when colonies are grown under the surface of blood agar plate.

- It is antigenic, and antibodies (ASLO) against it develop in group A streptococcal infection.
- Demonstration of ASLO antibodies is important for the determination of a recent group A streptococcal infection and also the late complications of streptococcal infections after the organisms have been eliminated from the host.

The SLO cross-reacts with similar hemolysins produced by streptococci of groups C and G, pneumolysins of *S. pneumoniae*, tetanolysin of *Clostridium tetani*, theta toxin of *Clostridium perfringens*, cereolysin of *Bacillus cereus*, and listeriolysin of *Listeria monocytogenes*.

**Streptolysin S:** SLS is a serum-soluble (hence named as S) and oxygen-stable protein. It is a small polypeptide of 20,000 Da and is nonantigenic. Hence, no antibodies against this toxin are demonstrated in serum. This toxin:

- Is responsible for hemolysis around the colonies grown on surface of the blood agar.
- Inhibits chemotaxis and is antiphagocytic.

**Pyrogenic exotoxins:** There are two types of exotoxins—exotoxin A and B.

- *Pyrogenic exotoxin A* is similar to that of staphylococcal toxic shock syndrome toxin (TSST). It has the same mode of action as staphylococcal TSST. It acts by releasing large amounts of cytokines from helper T cells and macrophages.
- *Pyrogenic exotoxin B* is a protease that rapidly destroys tissues and is produced in large amount by *S. pyogenes*.

### ▶ Pathogenesis of streptococcal infections

*S. pyogenes* produces suppurative as well as nonsuppurative streptococcal diseases by following mechanisms:

1. **Adherence:** Adherence of *S. pyogenes* to surface of host cells is the first stage in pathogenesis of the disease. The cocci adhere to the epithelium of the pharynx with the help of pili, lipoteichoic acid, F proteins, and M proteins. Initially, adherence is mediated by a weak binding between lipoteichoic acid and fatty acid of the cocci with fibronectin of epithelial cells of the host. Subsequently, a strong binding is established by M protein, F protein, and other adhesins of the cocci.
2. **Invasion by the cocci:** *S. pyogenes* invades into epithelial cells mediated by M protein, F protein, and other antigens of the cocci. Invasion of the cocci is suggested to be responsible for the persistence of infection, such as streptococcal pharyngitis, as well as for invasion into deep tissues.

Hyaluronic acid capsule, M protein, and C5a peptidase of *S. pyogenes* are antiphagocytic. These factors prevent opsonization and phagocytosis of bacteria in many ways.

- The capsule prevents phagocytosis of the bacteria by acting as a barrier between bacteria and cell.
- The M protein inactivates C3b, an important complement factor that mediates phagocytosis of bacteria.
- The M protein also binds to the fibrinogen and blocks the activation of complement by alternate pathway, thereby reducing the amount of C3b production.
- The C5a peptidase inactivates the complement component C5a, which mediates chemotaxis of neutrophils and phagocytes.

3. **Production of toxins and enzymes:** *S. pyogenes* then produces a wide variety of toxins and enzymes that contribute to pathogenesis of many streptococcal diseases.

### ▶ Host immunity

Acquired immunity to streptococcal infection is based on the development of specific antibodies against the antiphagocytic epitopes of M protein. The acquired immunity against a particular M type of streptococci lasts longer in untreated persons than in treated persons. Although such antibodies protect from infection against a homologous M protein type, they confer no immunity against other M serotypes. *S. pyogenes* is a highly communicable bacterium. It can cause disease in people of all ages who do not have type-specific immunity against the specific serotype.

## Clinical Syndromes

*S. pyogenes* produces a variety of clinical manifestations. These infections can be classified broadly as: (a) suppurative streptococcal diseases, (b) toxin-mediated disease, and (c) nonsuppurative streptococcal diseases.

### ▶ Suppurative streptococcal diseases

#### *Respiratory infections*

**Pharyngitis:** *S. pyogenes* is the most common bacterium causing pharyngitis or sore throat. Pharyngitis is characterized by inflammation of pharyngeal mucosa with exudate formation, tender enlarged cervical lymph nodes, fever, and leukocytosis. The condition is commonly seen in children and it spreads by droplet nuclei. The incubation period is 1–4 days. Uncomplicated pharyngitis resolves within 3–5 days.

#### *Skin and soft tissue infections*

**Pyoderma:** Pyoderma or impetigo is a localized infection of the skin, primarily affecting face, arms, legs, and other exposed parts of the body. The infection is acquired by direct contact with an infected person or fomites. The condition is caused by a limited number of serotypes (49, 53–55, 59–61, etc.) of *S. pyogenes*. The condition is seen mainly in young children. In tropics, impetigo is one of the important causes of acute glomerulonephritis (AGN) in children.

**Erysipelas:** Erysipelas is an acute and diffused infection of the skin, affecting the superficial lymphatics. It is characterized by red, swollen, and indurated skin with well-marked and raised borders. The affected skin is clearly demarcated from the surrounding healthy area. Commonly, face and legs are affected. Erysipelas occurs most commonly in young children or in older adults.

**Cellulitis:** Cellulitis is the infection of skin and subcutaneous tissues characterized by local inflammation like edema, erythema, tenderness, fever, headache, malaise, and other systemic manifestations. It is spreading in nature, often without any apparent focus of infection. The entry of the pathogen may be at a location distant to the lesion.

**Necrotizing fasciitis:** Necrotizing fasciitis occurs as a rapidly spreading streptococcal infection of superficial and deep fascia. The infection is caused by certain M strains of *S. pyogenes* (M types 1 and 3), which produce pyrogenic exotoxins. These strains are also called as “flesh-eating strains” due to the extensive destruction of muscle and fascia caused by them. The condition is also associated with a toxic shock-like syndrome, leading to disseminated intravascular coagulation and multisystem failure.

### Toxin-mediated diseases

**Scarlet fever:** Scarlet fever is a complication of streptococcal pharyngitis caused by certain strains of *S. pyogenes* producing pyrogenic exotoxins. It manifests as fever, pharyngitis, and by a characteristic rash. The rash is followed by desquamation. However, with the use of penicillin and other antibiotics, the suppurative complications of pharyngitis including scarlet fever have become rare.

**Streptococcal toxic shock syndrome:** Streptococcal toxic shock syndrome is caused by certain strains of *S. pyogenes* (M serotypes 1 or 3) that have prominent hyaluronic acid capsule. This is a condition similar to staphylococcal toxic shock syndrome. The condition manifests initially as pain at the site of inflammation and nonspecific systemic complaints, such as nausea, vomiting, diarrhea, fever, and chills. The condition progresses subsequently to multiorgan failure and shock. *S. pyogenes* is always isolated from the blood in toxic shock syndrome. The condition occurs in people of all ages. However, patients with HIV infection, varicella-zoster infection, diabetes, heart diseases, and intravenous drug and alcohol abusers are at high risk for streptococcal toxic shock syndrome.

### Other suppurative streptococcal diseases

Other pyogenic infections caused by *S. pyogenes* include lymphangitis, puerperal sepsis, abscesses of the internal organs (liver, lungs, kidneys, brain, etc.), and bacteremia.

### ► Nonsuppurative streptococcal diseases

**Acute glomerulonephritis:** AGN is a nonsuppurative complication of *S. pyogenes* infection. The onset of infection typically occurs 2–3 weeks following skin infection or pharyngitis caused

by certain pharyngeal (M types 1, 12) and pyoderma strains (M types 49, 53–55, 59–61) of *S. pyogenes*. M protein type 49 skin infection is most frequently implicated. The disease occurs as a result of deposition of antigen–antibody complexes on the glomerular basement membrane, initiating inflammation. This leads to the manifestation of disease with hypertension, generalized edema, hematuria, and proteinuria. It has an excellent prognosis, and most young patients usually recover completely.

**Rheumatic fever:** Rheumatic fever is an immunologically mediated disease, which affects the heart, joints, skin, and brain. It has a latent period of 2–4 weeks. It is characterized by fever, migrating polyarthritis, and carditis, and is frequently associated with subcutaneous nodules. Damage to heart valves may occur during the course of infection.

### Key Points

- Rheumatic fever occurs mainly due to antigenic cross-reaction between streptococcal proteins and the connective tissue antigens of the heart and joints.
- It is an autoimmune disease exacerbated by recurrence of streptococcal infection.
- The diagnosis of this condition is mainly clinical, supplemented by relevant laboratory investigations.
- If streptococcal infections are treated within 8 days after onset, rheumatic fever is usually prevented.

The comparison of AGN and rheumatic fever is presented in Table 24-3.

## Epidemiology

### ► Geographical distribution

*S. pyogenes* infections are worldwide in distribution.

- Prevalence of streptococcal *pyoderma* is higher in tropics with no seasonal variation, whereas it is more common in winter months in temperate countries.
- *Rheumatic fever* is most frequently observed in children aged 5–15 years, the age group most susceptible to *S. pyogenes* infections. The attack rate of rheumatic fever following upper respiratory tract infection is approximately 3% for persons with untreated or inadequately treated infections.

### ► Habitat

Streptococci are normal flora of the oral cavity, nasopharynx, skin, fingernails, perianal region, intestine, and upper respiratory tract of humans.

### ► Reservoir, source, and transmission of infection

Infected human cases are the reservoirs of infection. Respiratory and salivary secretions in the form of droplets and contaminated fomites are the sources of *S. pyogenes* infection.

Streptococcal carrier rate as high as 20–40% has been reported. However, these carriers with chronic asymptomatic pharyngeal and nasopharyngeal colonization are not usually

TABLE 24-3

## Differences between acute glomerulonephritis and acute rheumatic fever

Particulars	Acute rheumatic fever	Acute glomerulonephritis
Hereditary factors	Contribute	Not known
Initial site of infection	Throat	Skin/throat
Prior exposure to <i>Streptococcus pyogenes</i>	Essential	Not required
Serotypes involved	All serotypes	Pyodermal strains: M types 42, 49, 53–55, 59–61; throat infection strains: 1, 2, and 4
Immune response	Prominent	Lower
Complement level	Unaffected	Decreased
Repeated attacks	Common	Absent
Penicillin prophylaxis	Essential	Not required
Course of the disease	Static/progressive	Complete recovery
Prognosis	Variable	Excellent

at risk of spreading disease, as they mostly inhabit avirulent organisms.

- Person-to-person transmission is the main route of transmission. The infection is transmitted from person to person through respiratory droplets. The infection is also transmitted through breaks in the skin by direct contact with infected patient, fomites, or arthropod vectors. Children with untreated acute infections spread organisms by their salivary droplet and nasal discharge.
- Occasional food-borne and waterborne outbreaks have also been documented.

Overcrowding (crowded homes and class rooms) is an important factor in transmission of *S. pyogenes* infection. Both impetigo and pharyngitis are more likely to occur in children living in crowded homes and under poor hygienic conditions.

Bacteriocin and phage typing of streptococci are employed in research and epidemiologic studies.

## Laboratory Diagnosis

### ► Specimens

The nature of specimens to be collected for bacteriological investigations of *S. pyogenes* infections depends upon the disease manifestations. The frequently used specimens include:

- Throat swab, nasal swabs, high vaginal swabs (puerperal sepsis), pus or pus swabs, pharyngeal secretions, blood, cerebrospinal fluid, joint aspirate, edge aspirate of cellulitis, skin biopsy specimen, epiglottic secretions, bronchoalveolar lavage fluid, thoracocentesis fluid, or abscess fluid.
- A frozen section biopsy obtained in the operating room may be used in cases of suspected necrotizing fasciitis.

### ► Microscopy

Gram staining of pus or exudate is a rapid and presumptive diagnostic procedure for *S. pyogenes* infection of skin and soft tissues. The presence of Gram-positive cocci in pairs



FIG. 24-3. Gram-stained pus smear showing streptococci in chains (X1000).

and chains (Fig. 24-3) in association with leukocytes is suggestive of streptococcal infection. This is because *S. pyogenes* are not found as normal flora on the skin surface. However, demonstration of streptococci in respiratory specimens from a patient with pharyngitis by Gram staining is of no value, because the streptococci are found as part of the normal flora in the oropharynx.

### ► Culture

Throat swab culture is the most specific method for diagnosis of streptococcal pharyngitis. Ideally, the throat swab specimen should be collected from tonsils and posterior part of the oropharynx because more number of bacteria are present at this site than in the anterior part of mouth. After collection of the specimen, they are plated immediately on the blood agar plate, and in case of delay they are sent to the laboratory in Pikes transport medium. In laboratory, the specimens are inoculated on a 5% sheep blood agar and incubated at 37°C aerobically in the presence of 5–10% CO<sub>2</sub> for 2–3 days.

### Box 24-1 Identifying features of *Streptococcus pyogenes*

1. Gram-positive cocci arranged in short chains or pairs.
2. On blood agar, produces a clear zone of hemolysis (*beta-hemolysis*).
3. Positive for bacitracin susceptibility test.
4. Positive for L-pyrrolidonyl-alpha-naphthylamide (PYR) test.
5. Positive for group-specific C antigen by direct antigen detection tests.

#### ► Identification of bacteria

Culture of the swabs on blood agar shows a clear zone of beta-hemolysis (Fig. 24-2) surrounding the small translucent to opaque colonies. The identifying features of *S. pyogenes* are summarized in Box 24-1.

**Bacitracin sensitivity test:** *S. pyogenes* can be distinguished from other streptococcal groups by their sensitivity to bacitracin. In this method, a filter paper disc containing 0.04 U of bacitracin is applied on the surface of an inoculated blood agar and is incubated overnight. Any zone of inhibition around the colonies confirms the presence of *S. pyogenes* (Fig. 24-4, Color Photo 16). Bacitracin test is simple to perform and is useful for presumptive identification of *S. pyogenes*. It is positive in more than 95% of *S. pyogenes* strains and negative in nongroup A streptococci.

**L-pyrrolidonyl-beta-naphthylamide test:** This is a test performed to differentiate *S. pyogenes* from other beta-hemolytic streptococci. *S. pyogenes* produces the enzyme L-pyrrolidonyl-beta-naphthylamidase (PYRase), which hydrolyzes L-pyrrolidonyl-beta-naphthylamide to produce a substance called beta-naphthylamine. This substance can be detected in the presence of *p*-dimethylamino cinnamaldehyde by formation of a characteristic red color after applying a disc containing *p*-dimethylamino cinnamaldehyde on an inoculated agar plate followed by overnight incubation. This makes the presumptive identification of a strain as group A streptococci.

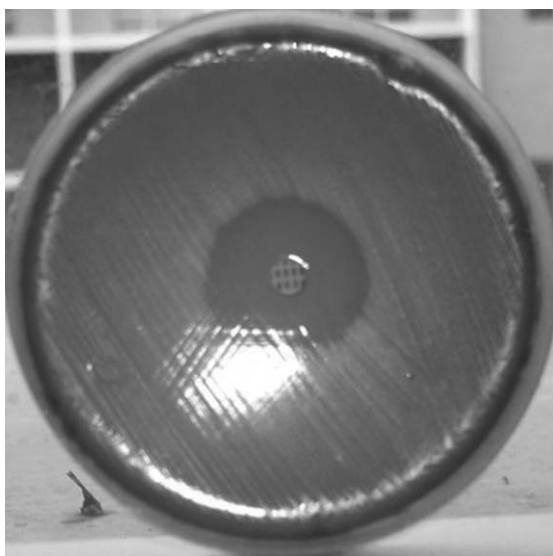

FIG. 24-4. Bacitracin sensitivity of *Streptococcus pyogenes*.

**Direct antigen detection test:** Detection of group-specific carbohydrate antigen A directly in the throat swabs by direct fluorescent antibody test is a very rapid and specific method. The result for this test is obtained within 4 hours. The test is as specific as culture but is less sensitive.

#### ► Serodiagnosis

Serological tests are of value in the diagnosis of AGN and rheumatic fever. These tests detect high level of antibodies produced against many streptococcal antigens. The tests detecting antibodies against SLO (anti-SLO, or ASO antibodies) are most frequently used for confirming rheumatic fever and AGN. The ASO antibodies appear in serum 3–4 weeks after initial infection by *S. pyogenes*. A titer of more than 200 indicates streptococcal infections. Higher antibody titers are found in acute rheumatic fever, whereas they are not raised in patients with glomerulonephritis and streptococcal pyoderma. Antibodies against other streptococcal enzymes, such as DNAase B (anti-DNAse B antibodies), hyaluronidase (anti-hyaluronidase antibodies), and streptokinase (anti-streptokinase antibodies) are also demonstrated in *S. pyogenes* infections. The demonstration of antibodies against these antigens may prove useful in the diagnosis of streptococcal pharyngitis and pyoderma.

#### Treatment

Treatment of *S. pyogenes* infections by antibiotics varies depending upon the clinical conditions. Penicillin is highly effective against *S. pyogenes*. As of now, no penicillin-resistant strains of *S. pyogenes* have been documented in clinical practice. Penicillin, therefore, remains the drug of choice, except in penicillin-allergic individuals (with pharyngeal infections) and in complicated or invasive diseases.

**Failures of penicillin therapy:** In uncomplicated cases, penicillin is given orally in a dosage of 250–500 mg twice daily for at least 10 days. Noncompliance is the most common reason for the failure to respond to therapy. The drug is often discontinued before the 10-day course is completed, because children usually appear to have recovered in 3–4 days. And the presence of beta-lactamase-producing flora (particularly organisms, such as mouth anaerobes), which could inactivate penicillin, has also been proposed. However, this theory is yet to be proved conclusively.

Most of the failures of penicillin therapy have been thought to occur in patients where streptococcal pharyngitis has not been well defined and some of these patients may in fact be streptococcal carriers who actually had viral pharyngitis.

- Erythromycin and clindamycin are given to patients allergic to penicillins. Recently, strains resistant to erythromycin have been reported.
- Sulfonamides and tetracycline are not used for streptococcal infections.

#### Prevention and Control

Chemoprophylaxis is most important in prevention of AGN or rheumatic fever.

## ► Chemoprophylaxis

Long-term chemoprophylaxis using penicillins to prevent streptococcal infection is recommended for patients with a history of acute rheumatic fever (up to age 21 years) or rheumatic heart disease (lifelong). Antibiotic prophylaxis prevents streptococcal reinfection and further damage to the heart. The role of chemoprophylaxis for household contacts of patients with either acute streptococcal disease or nonsuppurative complications is yet to be ascertained.

### Vaccines

Multivalent streptococcal vaccine containing multiple M protein epitopes has been evaluated; its efficacy is being proved in animal models. The vaccine is still in experimental stage and yet to be used in clinical practice.

## Streptococcus agalactiae

*S. agalactiae* is the only species belonging to group B streptococci. This is a pathogen of the cattle causing bovine mastitis, hence named “agalactiae”. *S. agalactiae* are Gram-positive cocci arranged in pairs and short chains in clinical specimens and are morphologically similar to *S. pyogenes*. The cocci grow readily on enriched medium, such as blood agar and produce large colonies after overnight incubation.

*S. agalactiae* are found as commensals in the genitourinary tract and lower gastrointestinal tract. Vaginal carriage rate as high as 40–50% has been observed in some pregnant women. More than 50% of infants born to these mothers through vaginal delivery are colonized with *S. agalactiae*.

- *S. agalactiae* in neonates can cause either early-onset or late-onset infections. Early-onset infection is acquired either *in utero* or from mother’s vagina during delivery. The clinical symptoms develop during the first week of life. The condition is characterized by septicemia, meningitis, or pneumonia. Late-onset infection is acquired from mother or from another infant (environment) during 2–12 weeks of life. The condition manifests as septicemia and meningitis.
- *S. agalactiae* in pregnant women causes urinary tract infection particularly immediately after delivery.
- In nonpregnant women and in men, *S. agalactiae* can cause infections, such as osteomyelitis, arthritis, peritonitis, and skin infections.

The condition is diagnosed by culturing the specimen in the blood agar and identifying the colonies by various tests as mentioned below:

**1. CAMP test:** CAMP (Christie, Atkins, Munch-Peterson) test was first described in 1944 by Christie, Atkins, and Munch-Peterson. The basis for the test is that *S. agalactiae* produces a diffusible and heat-stable protein, known as CAMP factor, which accentuates hemolysis of RBCs. The staphylococci

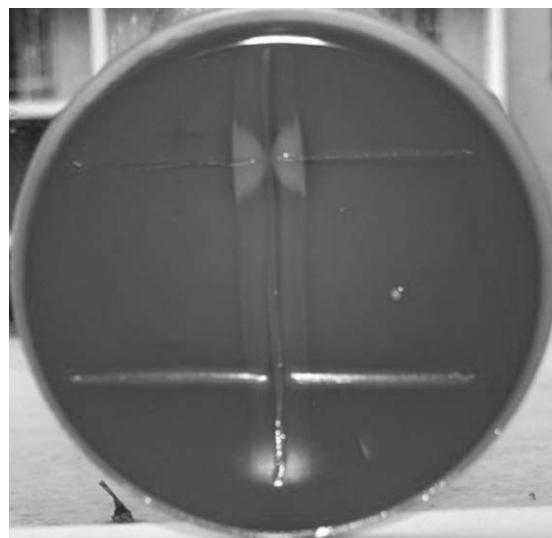

FIG. 24-5. CAMP test for *Streptococcus agalactiae*.

produce an enzyme sphingomyelinase C, which binds to the RBCs present in the blood agar. On exposure to CAMP factor liberated by *S. agalactiae*, RBCs undergo hemolysis, producing a butterfly appearance (Fig. 24-5, Color Photo 17). In this test, *S. aureus* is streaked from top to bottom on a blood agar plate. Then perpendicular streaks of *S. agalactiae* are made on either side, leaving at least 1 cm space from *S. aureus*. The plate is incubated overnight at 37°C in 20% CO<sub>2</sub>. Haemolysis showing a typical butterfly appearance indicates a positive test. *S. agalactiae* is CAMP positive.

**2. Hippurate hydrolysis test:** *S. agalactiae* are hippurate positive. They hydrolyze the hippurate to produce hippuric acid.

**3. Demonstration of group-specific cell wall antigen:** The bacteria are identified by the group-specific cell wall polysaccharide antigen or B antigen. This antigen is composed of rhamnose, *N*-acetylglucosamine, and galactose.

**4. Demonstration of type-specific capsular antigen:** Depending upon type-specific capsular polysaccharide antigens, *S. agalactiae* strains have been classified into 11 distinct serotypes (Ia, Ia/c, Ib/c, II, IIc, III, IV, V, VI, VII, and VIII). Serum antibodies confer specific protection against these serotypes. Penicillin is the drug of choice for treatment of *S. agalactiae* infection. Vancomycin is given to persons allergic to penicillins. Recently, strains resistant to erythromycin and tetracycline have been documented.

## Other Hemolytic Streptococci

Streptococci belonging to groups C, F, and G, and rarely H, K, O, and R can also be associated with human infections.

### Group C Streptococci

Group C streptococci are usually pathogens of animals. *Streptococcus equisimilis* is a group C *Streptococcus*, which can

cause occasional infections in humans. *S. equisimilis* resembles *S. pyogenes* in fermenting trehalose but differs from it by not fermenting ribose. Like *S. pyogenes*, it also produces SLO, streptokinase, and other proteins. It causes upper respiratory tract infections and also pneumonia, osteomyelitis, endocarditis, brain abscess, and puerperal sepsis.

*S. equisimilis* shows tolerance to treatment with penicillin; therefore patients may not respond to treatment with penicillin.

## Group F Streptococci

These cocci are called “minute streptococci”. They grow on blood agar well in the presence of CO<sub>2</sub>. *Streptococcus* MG is a member of this group that can cause primary atypical pneumonia in humans. Demonstration of cold agglutinins in serum is diagnostic of primary atypical pneumonia.

## Group G Streptococci

Group G streptococci are the commensals of humans and of animals, such as monkeys and dogs. They may occasionally cause infections, such as tonsillitis, urinary tract infection, and endocarditis in humans.

## Nonenterococcal Group D Streptococci

*Streptococcus bovis* and *Streptococcus equinus* are the nonenterococcal group D streptococci, which are associated with human infections, such as urinary tract infections and rarely endocarditis. They are susceptible to penicillins.

## Viridans Streptococci

Viridans streptococci are a heterogeneous group of alpha-hemolytic and nonhemolytic streptococci. These are found as commensal flora in the oral cavity, oropharynx, gastrointestinal tract, and genitourinary tract. These bacteria produce a green pigment on the blood agar and hence are called *viridans* (Latin for “green”). Most isolates of viridans streptococci do not possess a group-specific carbohydrate; hence, they cannot be classified under Lancefield classification of streptococci.

These cocci, however, have been classified into different species, such as *Streptococcus mutans*, *Streptococcus sanguis*, *Streptococcus mitis*, *S. salivarius*, etc. based on various properties, such as (a) cell wall composition, (b) production of dextrans and levans, and (c) fermentation of sugars.

Viridans streptococci are nutritionally fastidious, requiring complex media supported with blood for their growth. Growth of the colonies is facilitated by the presence of 5–10% carbon dioxide. Some strains are nutritionally deficient, requiring supplementation of pyridoxal, the active form of vitamin B<sub>6</sub> for their growth.

Viridans streptococci can cause a variety of infections. They are commonly implicated in dental caries, subacute bacterial endocarditis, and intra-abdominal suppurative infections.

TABLE 24-4

Important biochemical characters of common streptococci

Characters	<i>Streptococcus pyogenes</i>	<i>Streptococcus agalactiae</i>	Viridans streptococci
CAMP test	–	+	–
Hippurate hydrolysis	–	+	–
Bacitracin susceptibility	Sensitive	Resistant	Resistant

- *S. sanguis* is the most common causative agent of bacterial endocarditis in individuals with preexisting heart lesions. There is a transient bacteremia following tooth extraction or other dental procedures after which bacteria adhere to the damaged heart valves or prosthetic heart valves. Prophylactic use of antibiotics before dental procedures prevents such complications.
- *S. mutans* is an important causative agent of dental caries. It splits dietary sucrose, producing acid and a dextran. The acid damages the dentine. The dextran binds together exfoliative epithelial cells, mucus, food debris, and bacteria to form dental plaques.

Earlier, most strains of viridans streptococci were sensitive to penicillins. However, recently moderately resistant and highly resistant strains have been reported particularly in the *S. mitis* group. Broad-spectrum cephalosporins or vancomycin are recommended for treatment of these penicillin-resistant strains.

Table 24-4 summarizes the differences between important biochemical characteristics of common streptococci.

## Enterococcus

The enterococci were classified earlier as group D streptococci, because they possess the group D cell wall antigen. These enterococci, however, showed several distinctive features (Table 24-5) by which they were separated from the streptococci. Thiercelin proposed the term *Enterococcus* in 1899. The term enterococcal group was used by Sherman to describe the streptococci that grew at 10–45°C, with pH 9.6, in broth containing 6.5% sodium chloride and survived heating to 60°C for 30 minutes. Based on acid formation from mannitol, sorbitol, and sorbose

TABLE 24-5

Features for distinguishing *Streptococcus* and *Enterococcus*

Characters	<i>Streptococcus</i>	<i>Enterococcus</i>
Arrangement of bacteria	Pairs or in short chains	Pairs of oval cocci
Growth in the presence of 40% bile	–	+
Growth in the presence of 6.5% sodium chloride	–	+
Growth at 45°C	–	+
Growth at pH 9.6	–	+



broth and hydrolysis of arginine, genus *Enterococcus* is classified into five groups (Table 24-6). The genus *Enterococcus* has 16 species. *Enterococcus faecalis* and *Enterococcus faecium* are two important species known to cause human infections.

The enterococci are Gram-positive, spherical, oval, or coccobacillary and are arranged in pairs and short chains. Most of the species are nonmotile and noncapsulated. They grow at a temperature range of 35–37°C. Colonies on blood agar media are 1–2 mm in diameter and alpha-hemolytic (actually nonhemolytic; appearance of alpha-hemolysis is due to the production of the enzyme peroxidase rather than hemolysins). Some cultures are beta-hemolytic on agar containing rabbit, horse, or human blood but not on agar containing sheep blood. *Enterococcus durans* is beta-hemolytic on agar containing sheep blood as well. On MacConkey agar they produce tiny and magenta-colored colonies. On potassium tellurite agar they produce black colonies. Bile-esculin-azide

medium and Columbia colistin-nalidixic acid agar are used as selective media. They are catalase negative and are resistant to optochin and bile. They ferment sucrose, sorbitol, mannitol, and esculin. They are PYRase test positive, CAMP test negative, resistant to bacitracin, and they do not hydrolyze hippurate.

They possess two important virulence factors: (a) aggregation substances and (b) carbohydrate adhesions. Aggregation substances are hair-like proteins that facilitate binding of bacteria to the epithelial cells. Carbohydrate adhesins facilitate binding of cocci to host cells gelatinase. Cytolysin and pheromone are the other virulence factors. The cell wall of the bacteria possesses group-specific antigen, which is group D glycerol teichoic acid.

The enterococci are commonly found in gastrointestinal and genital tract of humans and animals. Enterococci are non-pathogenic but now are emerging as important agents of nosocomial infection. They cause urinary tract infection especially in hospitalized patients. Indwelling catheters and urinary tract instrumentation are important predisposing factors. They are frequently isolated from cases of wound infections particularly intra-abdominal. They also cause bacteremia, infection of the bile duct, and endocarditis.

The antimicrobial therapy includes combination of aminoglycosides with penicillin, ampicillin, or vancomycin. Enterococci are less sensitive to penicillin and gentamicin and are resistant to cephalosporins. Plasmid-mediated resistance is a major cause of resistance among drug-resistant strains of *Enterococcus*. Vancomycin-resistant *Enterococcus* (VRE) has been emerging in the recent years.

TABLE 24-6 Classification of *Enterococcus*

Groups	Species
Group I	<i>Enterococcus avium</i>
Group II	<i>Enterococcus faecalis</i> , <i>Enterococcus faecium</i> , <i>Enterococcus gallinarum</i>
Group III	<i>Enterococcus durans</i>
Group IV	<i>Enterococcus sulfurous</i> and <i>Enterococcus cecorum</i>
Group V	Variants of <i>Enterococcus faecalis</i> , <i>Enterococcus gallinarum</i>

## CASE STUDY

A 32-year-old male was admitted to a hospital with fever, chills, and generalized body pain. The patient had received multiple courses of antibiotics prescribed by private practitioners. Serum of the patient was tested positive for HIV by ELISA. Blood culture showed growth with Gram-positive cocci. The colonies were positive with group D antisera. These were PYRase test positive, CAMP test negative, resistant to bacitracin, and they did not hydrolyze hippurate. The bacterial isolate was identified as enterococci. The isolate showed resistance to penicillin and vancomycin.

- Which is the most likely bacteria species to cause this condition?
- What are the other tests you will perform to identify the bacteria?
- What antibiotics you will use to treat this infection?

# Pneumococcus

## Introduction

Pneumococcus was earlier classified as *Diplococcus pneumoniae*. The bacterium has now been reclassified as *Streptococcus pneumoniae* due to its genetic similarities to *Streptococcus pneumoniae*, however, differs from streptococci in its morphology (by having a specific polysaccharide capsule), bile solubility, and optochin sensitivity.

## *Streptococcus pneumoniae*

A lot of advances have been made toward the better understanding of the pathogenesis, antibiotic resistance, and use of vaccines in pneumococcal infections caused by *S. pneumoniae*.

## Properties of the Bacteria

### ► Morphology

*S. pneumoniae* shows the following morphological features:

- They are Gram-positive cocci measuring 0.5–1.25  $\mu\text{m}$  in diameter. Older cells decolorize rapidly and might appear Gram negative. *In clinical specimens*, they appear typically “lanceolate shaped” with one end pointed and the other end round. They are arranged in pairs (diplococci) with the broad ends in apposition to each other. *In cultures*, they usually appear more rounded and are arranged in short chains (Color Photo 18).
- They are capsulated. A polysaccharide capsule completely envelops each pair of cocci. The capsule is visualized by staining it directly with specific stains or by Indian ink negative staining or by Quellung reaction (Color Photo 19).
- They are nonsporing and nonmotile.

### ► Culture

*S. pneumoniae* is an aerobe and a facultative anaerobe. It grows at an optimum temperature of 37°C (range 25–42°C) and pH 7.8 (range 6.5–8.3). The growth is enhanced by the presence of 5–10% CO<sub>2</sub>. Pneumococci are fastidious. They grow only on an enriched media, such as blood agar or chocolate agar (supplemented with blood products), which will supply nutrients, pH buffers, etc.

**Blood agar:** On blood agar, morphology of the colonies varies depending on the nature of the strain (whether capsulated

or noncapsulated), the type of incubation (whether aerobic or anaerobic), and the time of incubation:

- Colonies on blood agar in anaerobic incubation show beta-hemolysis (greenish discoloration), but show alpha-hemolysis in aerobic incubation (Color Photo 20).
- Capsulated strains after overnight incubation produce round and mucoid colonies measuring 1–3 mm in diameter. Some strains, e.g., type 3 *S. pneumoniae* (most virulent), produce copious quantities of capsular material and hence produce large mucoid colonies. Noncapsulated strains produce small and flat colonies.
- On prolonged incubation, the colonies undergo autolysis and the centers become flattened or depressed (umbonation) and edges become raised, giving the colonies a typical draughtsman appearance (Fig. 25-1). The central flattening or depression is due to the production of intracellular enzymes, such as amidase, which lyses the bacteria. Bile salts, sodium lauryl sulfate, and other surface active agents enhance the process of autolysis of the bacterial colonies.

The capsules are present in strains isolated from clinical specimens but are lost on repeated cultivation, which is called smooth to rough variation.

**Smooth to rough variation:** The capsules are present in strains isolated from clinical specimens but are lost on repeated cultivation. This is called smooth to rough variation. Noncapsulated rough (R) strains are avirulent; these forms arise as spontaneous mutants and outgrow the parental smooth (S) strains in artificial culture. In tissues R forms are eliminated by phagocytosis. Transformation of a rough strain to a smooth one is also possible by treatment with smooth capsular substance containing DNA.

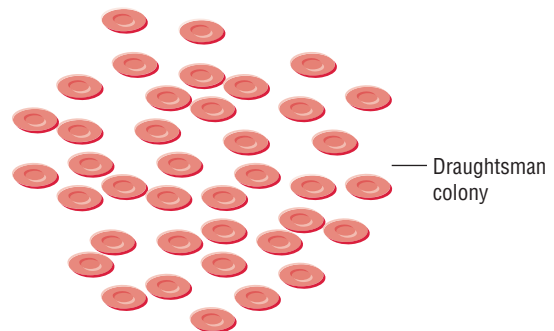

**FIG. 25-1.** Draughtsman colonies of *Streptococcus pneumoniae*.

## ► Biochemical reactions

*S. pneumoniae* shows following reactions:

- *S. pneumoniae* ferments many sugars, producing acid only but no gas. Fermentation of sugars is carried out in Hiss's serum water or in serum agar slopes.
- *S. pneumoniae* ferments inulin, and this is an important test to differentiate it from those streptococci that do not ferment inulin.
- *S. pneumoniae* produces an autolytic enzyme amidase, which solubilizes the peptidoglycan of the cell wall; hence in old cultures, typical draughtsman colonies are formed. This autolytic activity can be augmented by surface active agents, such as bile and bile salts.
- Bile solubility is a constant feature of pneumococci, and is positive in all the capsulated and some noncapsulated variants.
- Pneumococci are catalase and oxidase negative.

## ► Other properties

**Susceptibility to physical and chemical agents:** Pneumococci are delicate bacteria. They are killed by heating at 52°C for 15 minutes and by usual strengths of disinfectants. Pneumococcal colonies die on prolonged incubation.

**Optochin sensitivity test:** Pneumococci are sensitive to optochin (ethyl hydrocupreine)—a useful property to

differentiate these from streptococci. Optochin sensitivity is usually performed by a paper disk containing 5 µg of the compound; an inhibition zone of 14 mm or more indicates sensitivity to optochin. In recent times, occasional optochin-resistant pneumococci have also been documented. The target of optochin in pneumococci is an H<sup>+</sup> ATPase, and resistance is thought to be due to a point mutation in one of subunit a<sup>-</sup> or c<sup>-</sup> of the H<sup>+</sup> ATPase. This resistance to optochin is not related to the virulence of the bacteria.

## Cell Wall Components and Antigenic Structure

The cell wall of *S. pneumoniae* consists of the following components (Fig. 25-2):

- **Capsule:** The polysaccharide capsule surrounds the cell wall. The capsule is essential for virulence, its role being to protect the cocci from phagocytosis.
- **Cell wall:** It consists of peptidoglycan, teichoic acid, and proteins.
- **Peptidoglycan:** Peptidoglycan confers rigidity to the cell wall.
- **Teichoic acid:** The teichoic acid present in cell wall is of two types: (a) C polysaccharide and (b) Forssman or F antigen.
  - **C polysaccharide:** It is present on the surface of cell wall. The exposed part of teichoic acid, which is linked

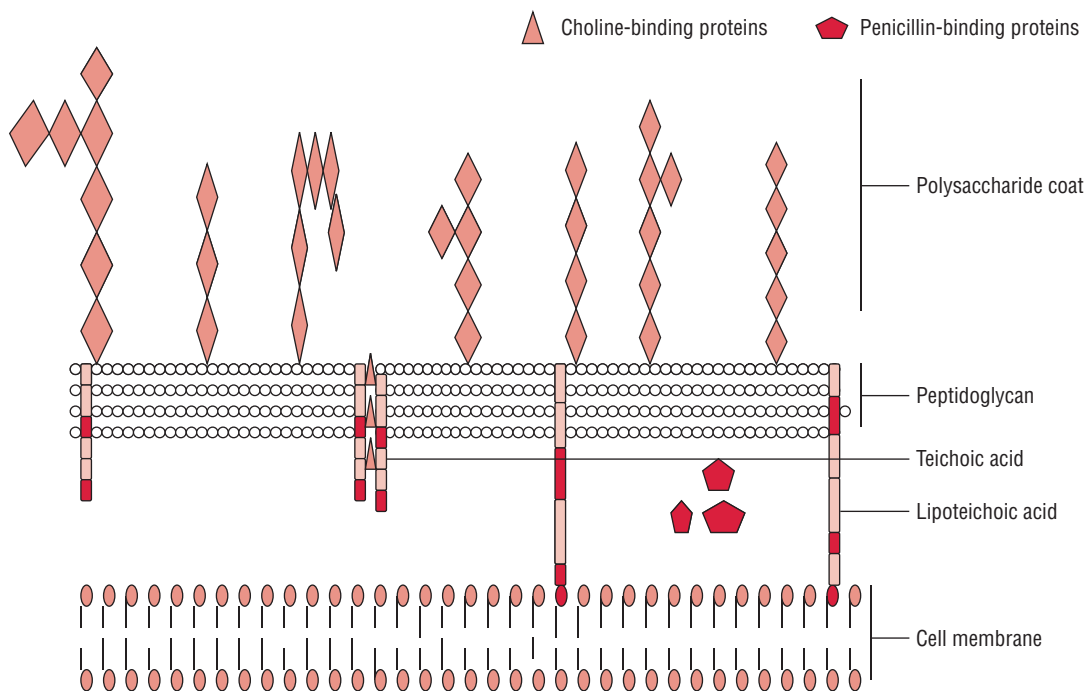

TAs are linked to the peptidoglycan via a phosphodiester linkage, whereas LTAs are linked to the cell membrane via a C-terminal fatty acylgroup.

Choline-binding proteins are linked to cell-wall TAs or LTAs via choline-binding domains (CBDs).

Penicillin-binding proteins (PBPs) are located in the periplasmic space and interact with the peptidoglycan.

**FIG. 25-2.** Schematic diagram of antigenic structure of *Streptococcus pneumoniae*.

to peptidoglycan layer and extends through the capsule, is known as C polysaccharide or C antigen. This is a species-specific antigen and in no way related to the group-specific C carbohydrate antigen found in beta-hemolytic streptococci. The C polysaccharide present in the cell wall of pneumococci precipitates with C reactive protein (CRP), a serum globulin.

- **C-reactive protein:** The CRP is an acute-phase substance synthesized in the liver. It is not produced specifically against C antigen of pneumococci. It is present in low concentrations in healthy individuals, but the concentration increases in inflammation, malignancies, and bacterial infections. CRP increases during pneumonia and disappears during convalescence, hence can be used as a prognostic tool. CRP is used as an index of the treatment in rheumatic fever and certain other conditions.
- **F antigen:** F antigen is the other type of teichoic acid, which is covalently bound to the lipids in cytoplasmic membrane. It is so called because it cross-reacts with the Forssman surface antigen of the mammalian cells. F proteins mediate the binding of pneumococci to the host cell surface.
- **M protein:** M protein is a type-specific protein similar to the M protein of *Streptococcus pyogenes*, but is immunologically distinct. Antibodies against M proteins are not protective, as they do not inhibit phagocytosis of pneumococci.

### ► Serotyping of pneumococci

Capsular polysaccharide is antigenic in humans and rabbits. The capsular polysaccharide is also called specific soluble substance (SSS) as it diffuses into the culture medium or infective pus or host tissues. *S. pneumoniae* are classified into more than 90 different serotypes (1–90) based on the antigenic structure of the capsular polysaccharide. Of these, only 23 serotypes are associated with pneumococcal diseases. Serotyping of *S. pneumoniae* is not carried out routinely and is done only for epidemiological studies. There are three typing methods:

- Agglutination of the bacteria with type-specific antiserum by co-agglutination (Co-A) test. The Co-A test is a rapid slide agglutination test, uses less antiserum, and is in complete agreement with Quellung test.
- Precipitation of the specific soluble substances with specific serum by counter-current immunoelectrophoresis (CIEP). This is also a rapid test used to serotype pneumococci.
- Capsular swelling reaction with type-specific antiserum by “Quellung reaction”. This is called capsular swelling reaction due to swelling (Latin *quellung*: swelling) of the capsule observed in this test. This reaction was first described by Neufeld in the year 1902. In this test, a drop of type-specific antiserum is added to a drop of suspension of pneumococci on a glass slide along with a drop of methylene blue solution. The capsule, in the presence of the specific homologous antiserum, becomes apparently swollen, clearly delineated, and refractile.

## Pathogenesis and Immunity

Pneumococci cause disease primarily by their capacity to multiply in host tissues by avoiding the host defense mechanisms (Table 25-1).

### ► Virulence factors

**Capsule:** Virulent strains of *S. pneumoniae* have a complex polysaccharide capsule. The acidic and hydrophilic nature of the capsule allows the bacteria to escape phagocytosis by macrophages.

**Pneumolysin:** Pneumolysin is a toxin produced by pneumococci. The toxin alters the mucociliary clearance function of respiratory epithelium and inhibits phagocytic cell oxidative burst essential for intracellular killing of the bacteria. It activates the classical complement pathway resulting in the production of C3a and C5a, thereby contributing to the disease process.

**IgA protease:** The enzyme produced by pneumococci disrupts secretory IgA-mediated clearance of the bacteria and thereby enhances the ability of the bacteria to colonize mucosa of the upper respiratory tract.

**Cell wall associated polymers and proteins:** These include teichoic acid, peptidoglycan, protein adhesin, phosphorylcholine, F protein, etc. that contribute to pathogenesis of pneumococcal diseases in various ways as mentioned in Table 25-1.

TABLE 25-1

### Virulence factors of *Streptococcus pneumoniae*

Virulence factors	Biological functions
<b>Cell wall associated polymers and proteins</b>	
Capsule	Prevents phagocytosis
Teichoic acid	Binds to epithelial cells and activates alternative complement pathway
Peptidoglycan	Activates alternative complement pathway
Protein adhesin	Binds to epithelial cells
Phosphorylcholine	Mediates invasion of host cell by cocci
<b>F protein</b>	Mediates attachment to epithelial cells
<b>Enzymes</b>	
Secretory IgA protease	Destroys secretory IgA
<b>Toxins</b>	
Pneumolysin	Alters mucociliary clearance function of respiratory epithelium and inhibits phagocytic cell oxidative burst essential for intracellular killing of the bacteria
Autolysin	N-acetyl muramoyl-L-alanine amidase that along with a glycosidase enzyme function during cell division to separate daughter cells and to break down the organism after exponential growth

## ► Pathogenesis of pneumococcal diseases

*S. pneumoniae* causes disease through the following stages: (i) colonization and invasion, (ii) tissue destruction, and (iii) avoidance of opsonization and phagocytosis.

**Colonization and invasion:** *S. pneumoniae* colonizes the oropharynx by adhering to the epithelial cells of pharynx. This adhesion is mediated by pneumococcal neuraminidase or by pneumococcal cell-surface ligands of the cocci called adhesins. The cocci also release an enzyme, secretory IgA protease, which destroys the secretory IgA and thereby enhances the ability of the cocci to colonize mucosa of the upper respiratory tract. Pneumolysin liberated by the cocci destroys the ciliated epithelial cells and phagocytic cells by binding to cholesterol in the epithelial cell membrane. This adversely affects mucociliary clearance function of respiratory epithelium.

**Tissue destruction:** The process of tissue destruction is mediated by factors, such as cell wall teichoic acid, peptidoglycan, and phosphorylcholine. The destructive action is further supplemented by hydrogen peroxide produced by the bacteria. The peptidoglycan-teichoic acid complex of the pneumococcus is highly inflammatory. This complex activates the alternate complement pathway producing C5a, which being chemotactic attracts neutrophils to the site of inflammation. Migration of inflammatory cells to the site of infection is the key feature of pneumococcal infection. The activated leukocytes produce cytokines, such as IL-1 and TNF- $\alpha$ , which further contribute to the migration of inflammatory cells to the site of infection, tissue damage, fever, and other manifestations of pneumococcal disease. Phosphorylcholine present in the bacterial cell wall binds with phosphodiesterase-activating factors of the host endothelial cells and helps the cocci to enter the host cells.

**Avoidance of opsonization and phagocytosis:** The ability to evade phagocytosis allows *S. pneumoniae* to survive, multiply, and spread to various organs. The antiphagocytic action of capsule is further supplemented by pneumolysin, which causes inhibition of phagocytic cell oxidative burst, required for intracellular killing of bacteria.

## ► Host immunity

Host immunity is type specific with production of anticapsular antibodies. These antibodies appearing in serum 5–8 days after the onset of infection are protective against the pneumococcal serotype causing the infection. Natural immunity follows infections as well as colonization.

## Clinical Syndromes

Ninety serotypes of *S. pneumoniae* have been identified with varying degrees of pathogenicity, out of which 23 serotypes are known to cause disease in humans. *S. pneumoniae* serotypes 3, 4, 6B, 9V, 14, 18C, 19F, and 23F cause the majority of invasive disease. *S. pneumoniae* causes (a) pneumonia, (b) meningitis, (c) sinusitis and otitis media, (d) bacteremia, and (e) other infections.

## ► Pneumonia

*S. pneumoniae* is the leading cause of bacterial pneumonia, both lobar and bronchopneumonia. Pneumonia develops when bacterium multiplies in the alveoli. Since the disease is associated with aspiration and is localized in the lower lobes of the lungs, it is called lobar pneumonia. Pneumonia is common at the extreme of ages, in children and in elderly, who have a more generalized bronchopneumonia.

*S. pneumoniae* is the most common bacterial cause of childhood pneumonia, especially in children younger than 5 years. Serotypes 6, 14, 18, 19, and 23 are responsible for most cases of pneumonia in children, while serotypes 1, 3, 4, 7, 8, and 12 cause pneumonia in adults leading to mortality in more than 5–10%. *Haemophilus influenzae* and *Moraxella catarrhalis* are the other causes of acute pneumonia. *Mycoplasma pneumoniae*, *Chlamydia pneumoniae* and *Legionella* spp. are the causative agents of atypical pneumonia.

## ► Meningitis

Pneumococcus is the most common cause of pyogenic meningitis in children, although the condition can occur in all age groups. Meningitis is always secondary to other pneumococcal infections, such as pneumonia, bacteremia, infections of the ear or sinuses. The bacteria reach the brain through blood stream or from nasopharynx (following head trauma or dural tear particularly with cerebrospinal fluid leak).

Pneumococcal meningitis is now emerging as a common cause of death in children and in adults. Meningitis caused by *S. pneumoniae* is associated with a higher mortality and more neurological complications than the meningitis caused by any other bacteria. Even with antibacterial therapy, the mortality due to pneumococcal meningitis is nearly 25%.

*Streptococcus agalactiae*, *Escherichia coli*, *Neisseria meningitidis*, *H. influenzae* type B, *Listeria monocytogenes*, *Pseudomonas* spp., *Flavobacterium meningosepticum*, and *Staphylococcus aureus* are the other bacteria causing meningitis.

## ► Sinusitis and otitis media

Sinusitis and otitis media occur in patients with prior viral infections. The viral infection lowers the mucosal immunity, facilitating the invasion by *S. pneumoniae*. Sinusitis caused by the pneumococci occurs in patients of all ages, but otitis media caused by the bacteria is seen only in young children. Pneumococci cause approximately 40% of otitis media cases. *H. influenzae* is another causative agent.

## ► Bacteremia

This condition is more frequent in children than in adults. Bacteremia occurs in more than two-thirds of patients with meningitis and in one-fourth of the patients with pneumococcal pneumonia. This does not occur in patients with sinusitis or otitis media.

### ► Other infections

These include spontaneous bacterial peritonitis, postsplenectomy sepsis, endocarditis associated with rapid destruction of heart valves, bone and joint infections (prosthetic or natural joint septic arthritis, occasionally as a complication of rheumatoid arthritis), myositis, and brain and epidural abscesses. All these infections result from seeding of tissues during bacteremia.

## Epidemiology

### ► Geographical distribution

*S. pneumoniae* is worldwide in distribution. It is the major cause of community-acquired bacterial pneumonia. *S. pneumoniae* serotypes 6, 14, 18, 19, and 23 are usually associated with infections in children, whereas serotypes 1, 3, 4, 7, 8, and 12 predominate in infections in adults. *S. pneumoniae* serotypes 6, 14, 18, and 23 cause 60–80% of lower respiratory tract infections.

Pneumococcal infection accounts for more deaths than any other vaccine preventable disease. Children between 6 months and 4 years of age and adults over 60 years of age are most commonly at risk for pneumococcal infection. In developing countries like India, the incidence of pneumococcal diseases in children is many times higher than that in the developed countries.

### ► Habitat

*S. pneumoniae* is a normal inhabitant of throat and nasopharynx. Nasopharyngeal colonization occurs in approximately 5–75% of the population. Colonization is more common in children than in adults. The colonization occurs at about 6 months of age.

### ► Reservoir, source, and transmission of infection

Pneumococci are strict parasites, and cause infection only under specific predisposing conditions like prior viral or other infections, aspiration, immune suppression, anatomical deformity, etc. *S. pneumoniae* infection occurs exclusively in human beings, and no animal reservoir is found in nature. Respiratory and pharyngeal secretions of carriers and patients are the sources of infection. Horizontal transmission requires close person-to-person contact, hence overcrowding facilitates spread of infection. Infection is acquired by inhalation of droplets nuclei and by coming in contact with contaminated fomites.

## Laboratory Diagnosis

### ► Specimens

Sputum, endotracheal aspirate, bronchoalveolar lavage fluid, cerebrospinal fluid (CSF), pleural fluid, joint fluid, abscess fluid, bones, and other biopsy material are the specimens collected for Gram staining and culture.

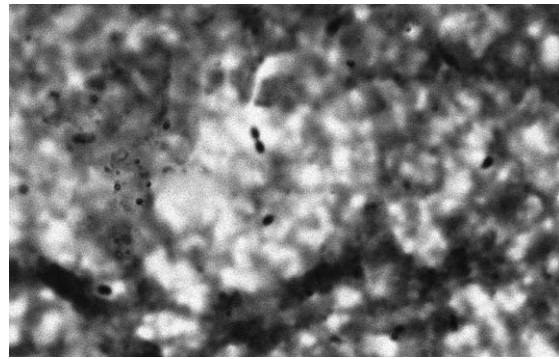

**FIG. 25-3.** Gram-stained smear of CSF showing *Streptococcus pneumoniae* in pairs ( $\times 1000$ ).

### ► Microscopy

**Gram staining of sputum:** It is a rapid method for diagnosis of acute pneumonia. Stained smears showing lanceolate-shaped, Gram-positive cocci in pairs surrounded by a capsule is good evidence for pneumococcal infection. The morphology of the pneumococci may be altered in the patient receiving antibacterial therapy.

### Key Points

**Gram staining of CSF:** It is a rapid method for demonstration of Gram-positive diplococci—inside the polymorphs as well as outside in a CSF smear. Gram staining is positive in 90% of these cases (Fig. 25-3, Color Photo 21).

**Gram staining of a buffy coat or blood smear:** It is frequently positive in cases of overwhelming pneumococcal sepsis and is useful for rapid presumptive diagnosis of this condition. In acute pneumococcal otitis media, Gram stain of an aspirated fluid smear from middle ear is useful to demonstrate the bacteria.

### ► Culture

Sputum is plated on blood agar and incubated in the presence of 5–10% carbon dioxide. Gray colonies with alpha-hemolysis are observed after overnight incubation. Sputum culture may be negative due to normal flora outgrowing pneumococci or due to rapid autolysis. Diagnosis of pneumococcal meningitis is confirmed by CSF culture and is positive in 90% of untreated cases. However, the culture is negative in more than 50% of cases who have received treatment even with a single dose of antibiotics. In the acute phase of pneumonia, the blood can be cultured in glucose broth. Demonstration of the pneumococci in the blood shows bad prognosis. Culture of aspirated fluid from the middle ear or from the sinus is a definitive method for diagnosis of otitis media or sinusitis. However, culture is not recommended for specimens collected from the nasopharynx or from external ear.

### ► Identification of bacteria

The identifying features of *S. pneumoniae* are summarized in Box 25-1. *S. pneumoniae* colonies are identified by the following tests:

### Box 25-1 Identifying features of *Streptococcus pneumoniae*

1. Gram-positive capsulated lanceolate cocci arranged in pairs.
2. On blood agar, produces *alpha* hemolysis.
3. Bile solubility test positive.
4. Optochin sensitivity test positive.
5. Inulin fermentation test positive.

**Optochin sensitivity test:** *S. pneumoniae* is identified by its sensitivity to optochin. In this method, a filter paper disc containing optochin (*ethylhydrocupreine dihydrochloride*) is applied on the middle of blood agar plate streaked with pneumococci and is incubated overnight. A zone of inhibition of 14 mm or more is observed around the disk after overnight incubation.

**Bile solubility test:** This is a very useful test to identify *S. pneumoniae*. It detects an autolytic enzyme, amidase, present in pneumococci, which breaks the bond between alanine and muramic acid of the peptidoglycan of the pneumococcal cell wall. The enzyme amidase is activated by bile salts present in bile, resulting in lysis of pneumococci. The test is carried out by applying a loopful of 10% sodium deoxycholate solution on the young colonies in the blood agar. Most colonies of pneumococci are dissolved within a few minutes.

**Inulin fermentation test:** Pneumococci ferment inulin; hence inulin fermentation test is a useful test to differentiate pneumococci from streptococci as the latter do not ferment it.

**Animal inoculation:** *S. pneumoniae* can be isolated from clinical specimens containing few pneumococci by intraperitoneal inoculation in mice. Pneumococci are demonstrated in the peritoneal exudate and heart blood of the mice, which die 1–3 days after inoculation.

Table 25-2 summarizes important biochemical tests used to differentiate pneumococci from viridans streptococci.

### ► Serodiagnosis

**Pneumococcal antigen detection:** The CIEP is a useful test to detect pneumococcal capsular polysaccharide antigen in the CSF for diagnosis of meningitis, and in the blood or urine for diagnosis of bacteremia and pneumonia. Latex agglutination test using the latex particles coated with anti-CRP antibody is employed to detect C reactive protein. The CRP is used as a prognostic marker in acute cases of acute pneumococcal pneumonia, acute rheumatic fever, and other infectious diseases. CRP is found in sera from cases of acute pneumonia but is absent during the convalescent phase of the disease.

**Pneumococcal antibody detection:** The indirect hemagglutination, indirect fluorescent antibody test, and ELISA are used to demonstrate specific pneumococcal antibodies in invasive pneumococcal diseases.

### Treatment

Most pneumococci are susceptible to penicillin, amoxicillin, and erythromycin.

TABLE 25-2

### Features for distinguishing pneumococci and viridans streptococci

Characters	<i>Streptococcus pneumoniae</i>	<i>Streptococcus viridans</i>
Arrangement of bacteria	Pairs of lanceolate diplococci	Pairs of oval cocci, short chains
Polysaccharide capsule	Present	Absent
Colonies	Draughtsman colonies	Dome shaped
Growth in liquid medium	Uniform turbidity	Granular turbidity
Bile solubility	Positive	Negative
Optochin sensitivity	Positive	Negative
Inulin fermentation	Positive	Negative
Quellung reaction	Positive	Negative
Intraperitoneal mice inoculation	Fatal	Nonpathogenic

### Vaccines

Pneumococcal vaccines are not recommended for general use, but for persons who are at higher risk of getting pneumococcal infections. Followings are the vaccines used recently:

1. **23-valent pneumococcal polysaccharide vaccine:** A 23-valent pneumococcal polysaccharide vaccine for use against pneumococcal infections is now available in many countries. The vaccine contains capsular antigens from each of 23 serotypes of *S. pneumoniae* most commonly involved in human infections.
  - The vaccine is effective and safe in children older than 5 years.
  - It is not recommended for use in children younger than 2 years, as polysaccharide antigen, being T-cell independent, does not induce adequate immune response in children younger than 2 years. There is no long-lasting immunity, and the antibody level attained is not adequate.
2. **7-valent pneumococcal conjugate vaccine:** This is a vaccine made available recently for the immunization of infants and toddlers against invasive pneumococcal disease caused by capsular serotypes 4, 6B, 9V, 14, 18C, 19F, and 23F. The polysaccharide antigen is conjugated with a T-cell-dependent protein and so it can be used in children younger than 2 years.

Vaccines are recommended for the following groups of persons:

1. Elderly persons aged 65 years or more.
2. Persons aged 2–64 years who are suffering from chronic illnesses, such as chronic cardiovascular disease, chronic pulmonary disease, chronic renal failure, nephrotic syndrome, diabetes mellitus, cirrhosis, and alcoholism.
3. Persons who are splenectomized, particularly those suffering from sickle cell disease.
4. Immunocompromised persons, such as with human immunodeficiency virus (HIV) infection, leukemia, lymphoma, Hodgkin disease, multiple myeloma, malignancy, organ or bone marrow transplantation and persons receiving immunosuppressive chemotherapy.

**Penicillin-resistant strains:** Most pneumococci are susceptible to penicillin. Strains that are susceptible to penicillin are also susceptible to nearly all other antibiotics. But since 1977, penicillin-resistant pneumococci are being increasingly documented. Penicillin-resistant strains may be moderately resistant (minimum inhibitory concentration, or MIC,  $>0.1-1 \mu\text{g}/\text{mL}$ ) or highly resistant (MIC  $\geq 2 \mu\text{g}/\text{mL}$ ). The resistance to penicillin and other beta-lactam antibiotics is not mediated by production of beta-lactamase enzymes, but is due to the modifications of proteins, such as penicillin-binding proteins (PBPs) found on the cell wall. These penicillin-resistant strains are also resistant to multiple drugs, such as cefotaxime, ceftriaxone, erythromycin, tetracycline, macrolides, and trimethoprim-sulfamethoxazole (TMP-SMX). Resistance is seen most often in *S. pneumoniae* serotypes 6, 9, 14, 19, and 23.

The success of antibiotic therapy depends on drug concentrations attained in the affected part of the body, which should be several times higher than the MIC of the organism.

Beta-lactam antibiotics are not used alone for the treatment of meningitis caused by penicillin-resistant pneumococci. This is because, adequate bactericidal levels against penicillin-resistant organisms in the central nervous system (CNS) are difficult to achieve with beta-lactam antibiotics. Ceftriaxone can be used for meningitis caused by ceftriaxone-susceptible pneumococci (MIC  $<0.5 \mu\text{g}/\text{mL}$ ). Amoxicillin is the drug of choice for treatment of otitis media, sinusitis, and pneumonia caused by penicillin-resistant pneumococci with intermediate resistance. Ceftriaxone is the drug of choice for non-CNS invasive pneumococcal diseases caused by penicillin- and ceftriaxone-resistant pneumococci. Vancomycin is used if the pneumococcus is resistant to ceftriaxone (MIC  $\geq 0.5 \mu\text{g}/\text{mL}$ ).

### Prevention and Control

Pneumococcal vaccines play an important role in prevention of pneumococcal diseases.



#### CASE STUDY

A 6-year-old child was admitted to hospital with high-grade fever ( $\geq 103^\circ\text{C}$ ), headache, stiff neck, vomiting, lethargy, and altered sensorium for 3 days. Gram staining of the CSF smear showed Gram-positive cocci. The same bacteria were isolated from CSF by culture. The patient died despite prompt treatment with ceftriaxone.

- Which are the most likely bacteria to cause this fulminant condition?
- What other diseases are caused by this bacterium?
- What are the vaccines available against the infection caused by the bacteria in children?
- Do the bacteria show any resistance to antibiotics?



# Neisseria

## Introduction

The genus *Neisseria* consists of Gram-negative, aerobic, nonsporing, nonmotile cocci, typically arranged in pairs (diplococci) with adjacent sides flattened together. The bacteria belonging to this genus are oxidase positive and mostly catalase positive. They ferment sugars with production of acid but no gas.

The genus *Neisseria* consists of 10 species. *Neisseria gonorrhoeae* and *Neisseria meningitidis* are the two important species that cause human infections. These two species are strictly pathogens for humans, whereas the other *Neisseria* species are commensals of the mouth and upper respiratory tract, and hence cause opportunistic infections. Human infections caused by *Neisseria* are listed in Table 26-1.

## *Neisseria gonorrhoeae*

*N. gonorrhoeae* is a strict human pathogen. It is the causative agent of gonorrhea, one of the most common sexually transmitted disease worldwide. Gonococci when transmitted non-sexually from the mother's genital tract to the newborn during birth cause ophthalmia neonatorum.

## Properties of the Bacteria

### ► Morphology

*N. gonorrhoeae* shows following features:

- *N. gonorrhoeae* are Gram-negative and aerobic diplococci. They are mostly intracellular—found within the polymorphonuclear (PMN) leukocytes—and some cells contain as

many as hundred cocci. Smears from the pus sample show the intracellular kidney-shaped cocci, typically arranged in pairs with concave sides facing each other.

- Freshly isolated bacteria may be capsulated. They do not form endospores.
- They are nonmotile.

### ► Culture

*N. gonorrhoeae* is a fastidious coccus. It requires complex media for growth. The cocci grow on enriched media, such as blood or chocolate agar. These cannot grow on ordinary media, such as nutrient agar or Mueller–Hinton agar. They are aerobes but can also grow anaerobically. They grow optimally at a temperature range of 35–36°C. They fail to grow at temperature less than 25°C or greater than 37°C. The growth of bacteria is enhanced by incubation in humid atmosphere supplemented with 5–10% CO<sub>2</sub>.

1. **Blood agar:** On blood agar at 24 hours, *N. gonorrhoeae* produces convex small colonies measuring  $0.6 \times 1.4 \mu\text{m}$  in diameter. These colonies are translucent with entire edges and finely granular surface. They are soft and easily emulsifiable. Gonococci are inhibited by fatty acids and trace metals present in the digested products of peptone found in the blood agar. Addition of soluble starch to the media neutralizes the toxic effects of the fatty acids.
2. **Selective media:** Thayer Martin medium (chocolate agar medium containing antibiotics, such as colistin, nystatin, and vancomycin) and modified New York City medium (a translucent medium containing vancomycin, colistin, trimethoprim, and either nystatin or amphotericin B) are selective media used for isolation of gonococci from the clinical specimens containing mixed microbial flora. In these media, the growth of contaminating bacteria is suppressed including that of commensal *Neisseria*. On these media, *N. gonorrhoeae* produces small, translucent, and convex colonies, which are soft and easily friable. Four types of colonies of gonococci have been recognized.
  - These are T1, T2, T3, and T4.
  - Types 1 and 2 are small and are brown pigmented colonies. The strains producing these colonies possess pili, are virulent and cause acute cases of gonorrhea.
  - Types 3 and 4 are large and are nonpigmented colonies. The cocci producing these colonies do not possess pili and are avirulent.

TABLE 26-1

### Human infections caused by *Neisseria* species

Bacteria	Diseases
<i>Neisseria gonorrhoeae</i>	Gonorrhea, disseminated gonococcal infections, ophthalmia neonatorum; and other gonococcal diseases: anorectal gonorrhea, gonococcal pharyngitis, and acute perihepatitis
<i>Neisseria meningitidis</i>	Meningitis and meningococemia; other meningococcal diseases: meningococcal pneumonia, septic arthritis, purulent pericarditis, and endophthalmitis
Other <i>Neisseria</i> species	Opportunistic infections

3. **Transport medium:** Stuart's transport medium is used for the collection and transport of clinical specimens to the laboratory for isolation and demonstration of *N. gonorrhoeae*.

### ► Biochemical reactions

*N. gonorrhoeae* shows following features:

- Gonococci ferment glucose with the production of acid but no gas.
- They do not ferment maltose, lactose, sucrose, or fructose. This is an important feature to differentiate *N. gonorrhoeae* from *N. meningitidis*. *N. gonorrhoeae* utilizes glucose only, whereas *N. meningitidis* utilizes both glucose and maltose.
- They do not reduce nitrates, and they do not produce hydrogen sulfide.
- They are oxidase and catalase positive.

### ► Other properties

**Susceptibility to physical and chemical agents:** The gonococci are highly delicate bacteria. They die rapidly on drying. They are also killed by soap, and many other disinfectants, such as phenol, chlorhexidine, and hexachlorophene and antiseptics. They are killed at a temperature as low as 25°C. Freeze drying or storing in liquid nitrogen are the most effective methods for storage of gonococci for a longer period.

## Cell Wall Components and Antigenic Properties

The cell wall of *N. gonorrhoeae* like any other Gram-negative bacteria consists of three layers: outer cell surface, middle peptidoglycan layer, and inner cytoplasmic membrane. These contain following proteins (Fig. 26-1).

### ► Outer membrane proteins

The outer membrane proteins (OMP) are present in the outer membrane. They mediate the uptake of iron essential for

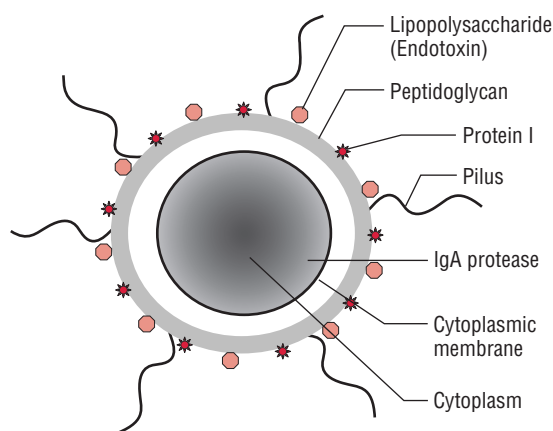

FIG. 26-1. Schematic diagram of *Neisseria gonorrhoeae*.

growth and metabolism of the cocci. They promote intake of iron by binding hemoglobin, transferrin, and lactoferrin. These proteins are of three types:

- The Por proteins
- The Opa proteins
- The Rmp proteins

**The Por proteins:** The Por proteins, earlier known as protein I, are porin proteins that form pores or channels in the outer membranes. Por proteins are of two types: Por-A and Por-B, each with a variety of antigenic variations. Strains producing Por-A proteins are commonly associated with disseminated disease because these proteins prevent killing of gonococci in the serum by the serum complement components. The antigenic variations observed in Por proteins form the basis for the serotype classification of *N. gonorrhoeae*.

**The Opa proteins:** These proteins, also known as opacity protein, were formerly known as protein II. These proteins are found in the membrane and mediate adherence of the bacteria to each other, and also to the eukaryotic cells. Strains producing Opa proteins produce opaque colonies in culture.

**The Rmp proteins:** These proteins, also known as reduction modifiable proteins, were formerly known as protein III. These are proteins found in the outer membrane of gonococci and lead to the production of antibodies that block serum bactericidal activity against gonococci.

### ► Other important gonococcal proteins

Lipo-oligosaccharide (LOS) is another major antigen present in the cell wall of the bacteria. This antigen consists of lipid A and oligosaccharide similar to that of lipopolysaccharide (LPS) of Gram-negative bacteria. However, LOS does not show antigenic variation as found in LPS. LOS possesses endotoxic activity. IgA1 protease and beta-lactamase are the other important proteins. IgA1 protease degrades secretory IgA1, whereas beta-lactamase degrades beta-lactam rings in the penicillin.

## Pathogenesis and Immunity

*N. gonorrhoeae* causes disease both by multiplying in tissues and by causing inflammation. The bacteria do not produce any toxins.

### ► Virulence factors

*N. gonorrhoeae* produces several virulence factors as mentioned below (Table 26-2):

**Capsule:** *N. gonorrhoeae* does not form a true carbohydrate capsule unlike *N. meningitidis*. Instead, it forms a polyphosphate capsule, which is loosely associated with its cell surface. Capsule is most evident in freshly isolated gonococci and is antiphagocytic. It prevents phagocytosis of the gonococci.

**Pili:** Pili are hair-like structures that extend from the cytoplasmic membrane through the outer membrane. The pili are composed of the proteins known as *pilins*, which are repeating

TABLE 26-2

Virulence factors of *Neisseria gonorrhoeae*

Virulence factors	Biological functions
<b>Capsule</b>	Prevents phagocytosis
<b>Pili</b>	Mediate attachment of gonococci to nonciliated epithelial cell; prevent ingestion and killing of gonococci by neutrophils
<b>Por proteins</b>	Confer resistance to serum killing of gonococci by preventing fusion of phagolysosome in neutrophils
<b>Opa proteins</b>	Mediate bacterial adherence to each other, and to the eukaryotic cells
<b>Rmp proteins</b>	Produce antibodies that block serum bactericidal activity against gonococci
<b>Lipo-oligosaccharide (LOS)</b>	Possesses endotoxic activity of the bacteria
<b>IgA protease</b>	Destroys IgA immunoglobulin
<b>Beta-lactamase</b>	Degrades beta-lactam rings in the penicillin
<b>Plasmids</b>	Plasmid-borne virulence determinants are associated with antimicrobial resistance

protein subunits. The expression of protein pilin is controlled by P gene complex. The pilins of all the strains of gonococci are antigenically different. There is a marked antigenic variation in gonococcal pili as a result of chromosomal rearrangement. More than 100 serotypes are known. The pili are important virulence factors:

- They play an important role in the virulence of the bacteria. They mediate attachment of gonococci to nonciliated epithelial cells.
- They also contribute to virulence by preventing ingestion and killing of gonococci by neutrophils.

**Other virulence factors:** These include:

- Por protein of outer membrane protein (OMP) confers resistance to serum killing of gonococci by preventing fusion of phagolysosome in neutrophils.
- Opa proteins mediate bacterial adherence of bacteria to each other and to the eukaryotic cells.
- Rmp proteins produce antibodies that block serum bactericidal activity against gonococci.

Lipo-oligosaccharide of the bacteria possesses endotoxic activity.

### ▶ Pathogenesis of gonorrhea

*N. gonorrhoeae* causes disease first by attaching themselves to mucosal cells. Subsequently, they enter the cells and multiply inside the cells and pass through the cells into the subepithelial space, thereby establishing the infection. Pili help in attachment of gonococci to mucosal surfaces and also contribute to the resistance by preventing ingestion and killing by PMN leukocytes. The outer membrane proteins, such as Opa proteins, facilitate adherence between gonococci and also increase

adherence to phagocytes. The Opa proteins also facilitate subsequent migration of gonococci into the epithelial cells. The Por proteins inhibit phagolysosome fusion in the phagocytes, thereby protecting the phagocytosed bacteria from intracellular killing. Production of beta-lactamase (penicillinase) by the bacteria also contributes to the invasion.

The host response is characterized by infiltration with leukocytes, followed by epithelial sloughing, formation of microabscesses in the submucosa, and production of purulent pus.

The LOS of gonococcal cell wall stimulates the production of tumor necrosis factor alpha (TNF- $\alpha$ ) and other inflammatory responses which contribute to most of the symptoms associated with gonococcal infection.

### ▶ Host immunity

The main host defense mechanisms against gonococci are antibodies (IgA and IgG), complement, and neutrophils. Antibody response to gonococci is characterized by the production of serum IgG antibodies. IgG3 is the predominant immunoglobulin. Antibody response is strong against Opa proteins and LOS, whereas it is minimal against Por proteins. Antibodies to LOS cause activation of complement, thus producing a chemotactic effect on neutrophils. Gonococcal infection does not confer protection against reinfection. Repeated gonococcal infections occur due to the antigenic changes of the pili and outer membrane proteins. Persons with a deficiency of the late-acting complement components (C6–C9) are at a risk of disseminated infections.

### Clinical Syndromes

*N. gonorrhoeae* cause following clinical syndromes (Fig. 26-2): (a) gonorrhea, (b) disseminated gonococcal infections (DGI), (c) ophthalmia neonatorum, and (d) other gonococcal diseases.

### ▶ Gonorrhea

Gonorrhea is a sexually transmitted disease. It is primarily a genital infection restricted to the urethra in men and cervix in women. The incubation period varies from 2 to 8 days.

**Gonorrhea in men:** A symptomatic acute infection is seen in approximately 95% of all infected men. Urethritis is the major clinical manifestation, with burning micturition and serous urethral discharge as the initial manifestation. Subsequently, the discharge becomes more profuse, purulent, and even blood-tinged. Acute epididymitis, prostatitis, and periurethral abscess are rare, but are noted gonococcal complications in men.

**Gonorrhea in women:** In women, endocervix is the primary site (80–90%) of infection because gonococci invade only the endocervical columnar epithelial cells. The bacteria cannot infect the squamous epithelial cells in the vagina of postpubescent women. Urethra (80%), rectum (40%), and pharynx (10–20%) are the other sites of infection in women. The infection is mostly asymptomatic in women. The presence of vaginal discharge, dysuria, dyspareunia, and mild lower abdominal pain are the common symptoms in symptomatic women. In 10–20% of infected women, the primary infection may spread

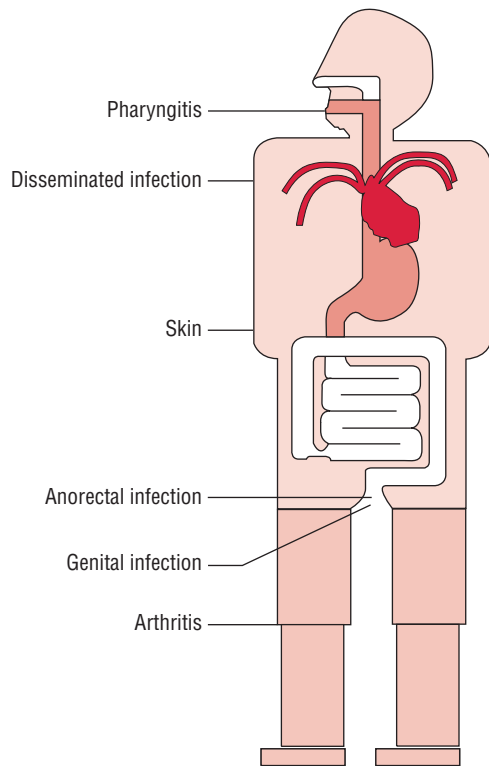

FIG. 26-2. Sites of infection caused by *Neisseria gonorrhoeae*.

from urethra and cervix to cause ascending genital infections including salpingitis, tubo-ovarian abscess, and pelvic inflammatory disease (PID).

- *Pelvic inflammatory disease* (PID) is the most important complication in females following gonococcal infection. Increased vaginal discharge or purulent urethral discharge, dysuria, lower abdominal pain, and intermenstrual bleeding are the common symptoms of the PID. Tubal scarring, ectopic pregnancy, and infertility are the major complications in women following PID.
- *Gonococcal vulvovaginitis* occurs in prepubertal girls through sexual contact.

### ► Disseminated gonococcal infections

Disseminated gonococcal infection (DGI) occurs because of hematogenous dissemination of gonococci from the primary site of infection. The symptoms vary greatly from patient to patient. Arthritis-dermatitis syndrome is the classic presentation of DGI. Joint or tendon pain is most common in the early stage of infection. Migratory polyarthralgia, especially of the knees, elbows, and more distal joints, and also tenosynovitis are the common symptoms. The skin lesions include maculopapular to pustular lesions often with a hemorrhagic component. Septic arthritis, especially of the knee, is the next stage of DGI. During this stage, skin lesions usually disappear and blood cultures for gonococci are always negative. The DGI is mostly seen in untreated asymptomatic women and in persons with complement deficiency.

## Key Points

The strains that cause DGI are characterized by their:

- Resistance to bactericidal action of serum,
- Marked sensitivity to penicillin, and
- Auxotropism for arginine, hypoxanthine, and uracil (for growth they require these substances in the medium).

### ► Ophthalmia neonatorum

Ophthalmia neonatorum is a nonsexually transmitted infection caused by *N. gonorrhoeae*. This is a condition of bilateral conjunctivitis of a neonate born by vaginal delivery to an infected mother. However, transmission to the newborn can also occur *in utero* or in the postpartum period. Pain in the eyes, redness, and purulent discharge are the common symptoms. Blindness is an important complication of this condition. Gonococci can cause permanent injury to the eye in a very short time; hence prompt recognition and treatment of the condition are very essential to avoid blindness.

### ► Other gonococcal infections

These include the following:

- Anorectal gonorrhoea and gonococcal pharyngitis occur in homosexual men following rectal intercourse or by oro-genital contact, respectively. Pharyngitis is most commonly acquired during orogenital contact. Pharyngitis often is asymptomatic, however, it may present as exudative pharyngitis with cervical lymphadenopathy.
- Purulent gonococcal conjunctivitis occurs in adults following autoinoculation of gonococci into the conjunctival sac from a primary site of infection, such as the genitals. The conjunctivitis may rapidly progress to panophthalmitis and loss of the eye unless promptly treated.
- Acute perihepatitis (Fitz-Hugh and Curtis syndrome) occurs due to the direct extension of *N. gonorrhoeae* or *Chlamydia trachomatis* from the fallopian tube to the liver capsule and overlying peritoneum.

## Epidemiology

### ► Geographical distribution

Gonococcal infection is reported throughout the world. However, the incidence is much lower in the European countries, and this condition has virtually been eliminated in Sweden. The highest incidence of gonorrhoea and its complications occurs in developing countries. The median prevalence of gonorrhoea in pregnant women has been estimated to be 4% in Asia, 5% in Latin America, and 10% in Africa.

### ► Habitat

*N. gonorrhoeae* is exclusively a human pathogen. The gonococci are only found in infected conditions. In infected women, the gonococci are most commonly found in the endocervix, and in

infected men found in the urethra. In both men and women gonococci can also be found in the pharynx, rectum, and eyes. The gonococci are not found as normal human flora in the mucosa of the urethra, cervix, or vagina.

### ► Reservoir, source, and transmission of infection

Only humans, especially asymptomatic infected men and women, are reservoirs of infections. Asymptomatic carriage is more common in women than in men. Purulent urethra or cervical discharge is the most common source of infection. The infection is transmitted:

- Primarily by sexual contact. *N. gonorrhoeae* infection occurs following mucosal inoculation during vaginal, anal, or oral sexual contact. Increased sexual contact with infected partners increases the risk of acquiring the infection.
- Less frequently, by nonsexual contact. Ophthalmia neonatorum is acquired nonsexually. This infection occurs following a conjunctival inoculation during vaginal delivery. Less frequently, the disease is transmitted through rectum, oropharynx, or through the birth canal.

Fomites do not play any role in transmission of the disease, because gonococci die rapidly outside the human body.

**Strain typing:** Strains of *N. gonorrhoeae* can be typed by (a) auxotyping and (b) serotyping.

- **Auxotyping** is based on addition of specific nutrients and cofactors in the medium for the growth of gonococci. There are over 30 auxotypes. The most common auxotypes are prototrophic or wild type (Proto), praline-requiring type (Pro), and the strains requiring arginine, hypoxanthine, and uracil (AHU).
- **Serotyping** is based on the OMP “Porin”, which is further divided into serovars (e.g., 1A-4, 1B-12) based on agglutination with a panel of monoclonal antibodies.

## Laboratory Diagnosis

Laboratory diagnosis of gonococcal infection depends on demonstration of *N. gonorrhoeae* at the site of infection.

### ► Specimens

The genital (urethral discharge, cervical discharge, etc.), rectal, and pharyngeal specimens are collected for the isolation and identification of gonococci.

- **In acute gonococcal infection**, urethral discharge in males and cervical discharge in females are the specimens of choice. High vaginal swab in females is not satisfactory.
  - When collecting specimens, such as endocervical discharge in women, the cervix is first cleaned of the exudate; a swab is then placed into the external os and rotated for several seconds.
  - In males, discharge present at the meatus is collected for examination. The meatus is first cleaned with gauze soaked in saline. The urethral discharge is then collected with the help of a platinum loop. If no discharge is

present at the meatus, urethral specimens are collected by inserting and rotating a small swab 2–3 cm into the urethra. A calcium alginate or Rayon swab on a metal shaft is usually used for this purpose.

- **In chronic infection**, since urethral discharge is less, the exudate after prostatic massage or morning drop of secretion and urine are also examined for the cocci. Rectal specimens are frequently useful for demonstration of gonococci in asymptomatic women and in homosexual and bisexual men.
- Samples are collected from all possible mucosal sites, such as pharynx, urethra, cervix, and rectum, and from blood and synovial fluid in patients with possible DGI.

After collection, the specimens are transported and processed immediately in the laboratory. If delay is unavoidable, specimens are collected and transported to the laboratory in a transport medium, such as Stuart’s transport medium.

### ► Microscopy

**Gram stain of urethral exudates:** The presence of four or more polymorphonuclear (PMN) leukocytes per oil-immersion field in Gram-stained urethral exudate smear is diagnostic of urethritis:

- Demonstration of typical Gram-negative intracellular diplococci is characteristic of *N. gonorrhoeae* (Fig. 26-3, Color Photo 22).
- Gram stain helps in the presumptive diagnosis of the gonococcal infection.
- It is more than 90% sensitive and 98% specific for the diagnosis of gonococcal infection in symptomatic males. However, in asymptomatic males, the sensitivity of the Gram stain is only 60% or less.

In women, presence of more than 10 PMN per high-power field on an endocervical smear is suggestive of cervicitis. Gram stain of endocervical smears is less sensitive (50–60%) and 82–90% specific in both symptomatic and asymptomatic women.

Gram stain is not a sensitive method for detection of gonococci in patients with anorectal gonorrhea, pharyngitis, and

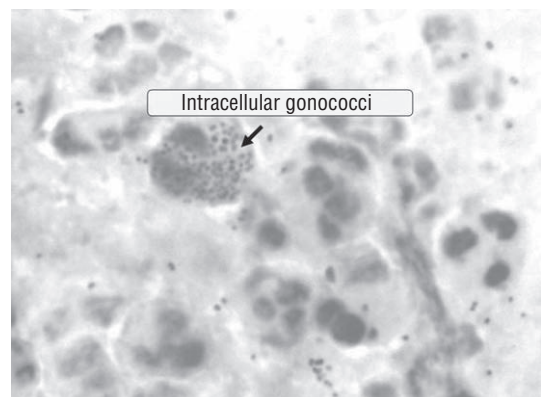

**FIG. 26-3.** Gram-negative intracellular *Neisseria gonorrhoeae* in Gram-stained smear of pus exudate ( $\times 1000$ ).

skin lesions. Specificity is also less because commensal *Neisseria* species in the oropharynx and gastrointestinal tract can be confused with those of *N. gonorrhoeae*.

**Wet mount examination of centrifuged deposit of urine sample:** In men, the urine sample, preferably 10–15 mL of early morning (the first) voided urine, is collected and centrifuged and examined under high power. The demonstration of 10 or more PMN in the centrifuged urine under high power is suggestive of urethritis.

### ► Culture

Isolation of *N. gonorrhoeae* from clinical specimens by culture confirms the diagnosis of gonorrhea. Genital, rectal, and pharyngeal specimens are inoculated on a nonselective medium (e.g., blood agar or chocolate agar) and on a selective medium (e.g., Modified Thayer Martin medium).

The colonies of gonococci on chocolate agar after 48 hours of incubation at 35–36°C in the presence of 5–10% CO<sub>2</sub> are small, round, translucent, and convex with finely granular surface. On Thayer Martin medium, the colonies show similar morphology as that on chocolate agar. The mixed microbial flora present in the clinical specimens is suppressed by the selective media. However, the vancomycin present in the selective media inhibits some strains of gonococci.

### ► Identification of bacteria

*N. gonorrhoeae* are identified by the characteristics listed in Box 26-1. They are differentiated from *N. meningitidis* and other *Neisseria* species by a variety of tests (Table 26-3).

#### Box 26-1 Identifying features of *Neisseria gonorrhoeae*

1. Gram-negative diplococci.
2. On blood agar, produces translucent colonies with entire edge and granular surface.
3. Oxidase test positive.
4. Catalase test positive.
5. Ferments glucose with production of acid.
6. Does not ferment maltose or sucrose.

### ► Detection of gonococcal antigen

The gonococcal antigens can be detected by both direct fluorescent antibody (DFA) test and direct enzyme-immunoassays (EIA) in urethral discharge and endocervical discharge as well as in other clinical specimens.

The DFA using fluorescein-conjugated monoclonal antibodies is a rapid and useful method for demonstration of gonococcal antigens in clinical specimens. The EIA using polyclonal antigonococcal antibodies are also used for the detection of gonococcal antigens in clinical specimens.

### ► Serodiagnosis

The serological tests are done to detect gonococcal antigens or specific anti-gonococcal antibodies in the serum for diagnosis of gonorrhea. ELISA and RIA (radioimmunoassays) using whole cell lysates, pilus proteins, and LPS antigens of the gonococci demonstrate antibodies in the serum.

These serological tests are not recommended for routine use. These are used only in specific situations, such as chronic gonorrhea, gonococcal arthritis, etc.



#### Molecular Diagnosis

DNA probes (*Gen probe*) are commercially available for the direct detection of bacteria in the genital and other clinical specimens.

- These probes are specific for nucleic acid of *N. gonorrhoeae* and are sensitive and rapid.
- The results become available within 2–4 hours, but these tests are highly expensive.

### Treatment

Sulfonamides were used as early as in 1935 for treatment of gonorrhea. In the beginning, all the strains of gonococci were sensitive to sulfonamides but subsequently, they developed resistance to these antibiotics. Penicillin is the drug of choice for penicillin-sensitive strains of *N. gonorrhoeae*.

TABLE 26-3

Differential characteristics of *Neisseria* species

<i>Neisseria</i> species	Growth on				Production of acid from			
	BA at 22°C	CHA	NA at 35°C	Thayer Martin medium	Glucose	Maltose	Sucrose	Lactose
<i>Neisseria gonorrhoeae</i>	–	–	–	+	+	–	–	–
<i>Neisseria meningitidis</i>	–	–	V	+	+	+	–	–
<i>Neisseria lactamica</i>	V	V	+	+	+	+	–	+
<i>Neisseria sicca</i>	+	+	+	–	+	+	+	–

V = variable.

**Penicillin-resistant strains of *N. gonorrhoeae*:** Initially, gonococci were highly sensitive to penicillin (minimal inhibitory concentration, or MIC, 0.005 U/mL). However, since 1957, strains of gonococci with decreased sensitivity (MIC >0.1 U/mL) to penicillin have been documented. The concentration of penicillin required to inhibit the growth of gonococci has increased by many folds and is now considerably higher (2.4–4.8 MU).

- Most of them are beta-lactamase (penicillinase) producing by the virtue of plasmid transmission. These strains show high level of resistance to penicillin.
- Some strains of *N. gonorrhoeae* not producing beta-lactamase but yet showing resistance to penicillin have also been reported. This resistance is mediated chromosomally and is of low level.

**Resistance to other antibiotics:** Chromosomal-mediated resistance to other antibiotics, such as tetracycline, erythromycin, and aminoglycosides, has also been reported.

- Tetracyclines are no longer given for gonococcal infection because of the prevalence of tetracycline resistance.
- Resistance to ciprofloxacin has also been increasingly documented in Southeast Asia, Africa, and Australia.

## Key Points

**Alternative drugs in cases of penicillin resistance or in penicillin-allergic individuals:** Ceftriaxone, cefixime, ciprofloxacin, or ofloxacin are the alternative drugs in cases of penicillin resistance or in penicillin-allergic individuals. A single-dose regimen of any of these antibiotics is given as an initial therapy in uncomplicated urethritis, cervicitis, or rectal or pharyngeal infections in adults. A single dose of ceftriaxone 125 mg intramuscularly or cefixime (400 mg), ciprofloxacin (500 mg), or ofloxacin (400 mg) as a single dose orally is also effective.

Immediate saline irrigation and intravenous ceftriaxone are effective for treatment of gonococcal conjunctivitis. Local application of 0.5% of erythromycin ophthalmic ointment or 1% tetracycline or 1% silver nitrate ointment is effective for treatment of gonococcal ophthalmia neonatorum.

PID as such is a mixed infection of gonococci, *Chlamydia*, and other facultative anaerobic pathogens. The treatment, therefore, is by broad-spectrum antibiotics to cover all infecting organisms.

## Prevention and Control

Currently, there is no effective vaccine available against *N. gonorrhoeae*. Chemoprophylaxis by the prophylactic use of penicillin is also ineffective and may promote the development of resistant strains. Therefore, (a) health education, (b) early detection of cases, (c) tracing of contacts, and (d) follow-up of screening of sexual contacts is important in the prevention of gonorrheal epidemics. Furthermore, the prevention of gonorrhea involves the promotion of safe sex and individual counseling. Gonococcal conjunctivitis in the newborns is prevented by using erythromycin ointment.

## *Neisseria meningitidis*

*N. meningitidis* causes a spectrum of diseases ranging from meningococemia (which is rapidly fatal) to a transient bacteremia (which is relatively benign). It is also the second most common cause of community-acquired meningitis in adults.

## Properties of the Bacteria

### ► Morphology

*N. meningitidis* shows following features:

- *N. meningitidis* are Gram-negative, spherical, or oval cocci arranged in pairs with the adjacent sides flattened. The cocci are generally intracellular in PMN in smears from pus cells and other specimens.
- They measure 0.6–0.8  $\mu\text{m}$  in diameter.
- Freshly isolated bacteria are usually capsulated.
- They are nonmotile and nonsporing.

### ► Culture

Meningococci are strict aerobes. They grow optimally at a temperature between 36°C and 39°C and optimum pH of 7.4–7.6. Their growth is enhanced by incubation in a moist atmosphere in the presence of 5% CO<sub>2</sub>.

Meningococci are fastidious bacteria with complex nutritional requirements. They do not grow on ordinary media, but grow well on the medium enriched with blood or serum, such as blood agar, chocolate agar, and Mueller–Hinton agar. The blood or serum promotes growth of bacteria by neutralizing inhibitory substances found in the media rather than by providing additional requirements.

1. **Blood agar:** On blood agar, *N. meningitidis* produces small, round (1–2 mm in diameter), convex, gray, and translucent nonpigmented colonies with entire edges after 24 hours of incubation. At 48 hours, the colonies become larger with an opaque raised center and cretated with transparent margin. It does not produce any hemolysis on blood agar. Strains of meningococci with large polysaccharide capsule appear as mucoid colonies. Meningococci produce large colonies on chocolate agar.
2. **Selective media:** Thayer Martin medium with antibiotics (vancomycin, colistin, nystatin, and trimethoprim) and New York City medium are the selective media commonly used for the isolation of the bacteria from clinical specimens containing mixed bacterial flora.

### ► Biochemical reactions

*N. meningitidis* shows following reactions:

- *N. meningitidis* is oxidase and catalase positive. These two tests are important biochemical markers for preliminary identification of this organism. *Alcaligenes* spp., *Aeromonas* spp., *Vibrio* spp., *Campylobacter* spp., and *Pseudomonas* spp. are the other bacteria that are oxidase positive.

### Box 26-2 Identifying features of *Neisseria meningitidis*

1. Gram-negative diplococci arranged in pairs.
2. On blood agar, produces convex, gray, and translucent colonies.
3. Oxidase test positive.
4. Catalase test positive.
5. Ferments glucose and maltose with production of acid.
6. Does not ferment sucrose or lactose.

- **Oxidase test:** The test can be performed in two ways: In the first method, 1% solution of oxidase reagent (tetramethyl paraphenylene-diamine-dihydrochloride) is poured on the culture media; the *Neisseria* colonies turn deep purple. In the second method, a few colonies of *Neisseria* are rubbed with a glass rod on a strip of filter paper moistened with oxidase reagent. A deep purple color develops immediately.
- *N. meningitidis* ferments glucose and maltose with acid but no gas. It does not ferment sucrose or lactose. Fermentation tests are required for final identification of *Neisseria* species (Box 26-2). It does not produce hydrogen sulphide and does not reduce nitrates.

#### ► Other properties

**Susceptibility to physical and chemical agents:** *N. meningitidis* are highly delicate organisms. They are highly sensitive to heat, desiccation, and disinfectants.

### Cell Wall Components and Antigenic Structure

The cell wall of pathogenic meningococci contains a toxic LPS or endotoxin. The meningococcal endotoxin is chemically identical to the endotoxin of enteric bacilli.

#### ► Antigenic structure

Depending on group-specific capsular polysaccharide antigens, meningococci are subdivided into 13 serogroups (A, B, C, D, X, Y, Z, W135, 29E, H, I, K, and L).

- Meningococci belonging to group A, B, and C are responsible for most of the epidemics and outbreaks of meningitis.
- Group Y and group W135 meningococci cause disease more commonly than groups X and Z.
- Meningococci that lack group-specific antigens are considered nonpathogenic.

Each serogroup includes many serotypes. The classification of the isolates of meningococcal serogroups into their serotypes is based on the differences in the proteins in the outer membrane and in the oligosaccharide part of LOS. For example, Group A meningococci has a single serotype, whereas group B and C meningococci consist of many serotypes. Serotyping of strains is useful for the identification of virulent strains for epidemiological studies.

TABLE 26-4

### Virulence factors of *Neisseria meningitidis*

Virulence factors	Biological functions
<b>Capsule</b>	Prevents phagocytosis
<b>LOS endotoxin</b>	Causes damage of the blood vessels associated with meningococcal infections
<b>IgA protease</b>	Destroys IgA immunoglobulin, thereby helps gonococci to attach to the epithelial cells of the upper respiratory tract
<b>Lipooligosaccharides</b>	Stimulates release of TNF- $\alpha$ , which results in host cell damage

### Pathogenesis and Immunity

*N. meningitidis* colonizes the human nasopharynx, and under specific conditions, invades the blood stream and then reaches the brain, causing meningitis.

#### ► Virulence factors

*N. meningitidis* has three important virulence factors, which are responsible for causing disease. These are (a) capsular polysaccharide, (b) LOS endotoxin, and (c) IgA protease (Table 26-4).

**Capsular polysaccharide:** *N. meningitidis* is surrounded by a prominent polysaccharide capsule that is antiphagocytic. The capsule is an important virulence factor, which contributes to the virulence by inhibiting phagocytosis. The capsule protects meningococci from destruction by the leukocytes. Inside the phagocytic vesicle of the leukocyte, they survive intracellular death, multiply, and then migrate to subepithelial spaces.

**LOS endotoxin:** LOS endotoxin is present in the outer membrane of *N. meningitidis*. It is responsible for damage of the blood vessels associated with meningococcal infections. The endotoxin comprises two antigenic determinant components: (a) a protein component and (b) a carbohydrate component. The continuous production and release of endotoxin by *N. meningitidis* cause severe endotoxin reaction, seen in patients with meningococcal disease.

**IgA protease:** IgA protease is the other important virulence factor. The enzyme acts by clearing the secretory IgA, thus helping the bacteria to attach to the epithelial cells of the upper respiratory tract.

#### ► Pathogenesis of meningitis

Initially, *N. meningitidis* causes a localized infection by colonizing the nasopharynx. From this site, the meningococci invade the submucosa by circumventing the host defense mechanisms and gain access to the central nervous system (CNS). Meningococci reach CNS by the following ways:

1. **Invasion of blood stream:** This is the most common mode of spread of meningococci. Once inside the blood stream, the meningococci escape the immune surveillance (e.g., antibodies, complement-mediated bacterial killing,



neutrophil phagocytosis) of the host and subsequently reach distant sites including the CNS. The specific mechanism by which the meningococci reach the subarachnoid space still remains to be clearly understood.

2. **Direct contiguous spread:** Meningococci can also reach the CNS by direct contiguous spread from nasopharynx. Inside CNS, the bacteria multiply and survive because host defense mechanisms (such as immunoglobulins, neutrophils, and complement) appear to have limited role in controlling multiplication of the bacteria. Uncontrolled multiplication of bacteria continues in the CSF, which subsequently causes a cascade of meningeal inflammation. Meningococcal infection of the nasopharynx is usually subclinical. Asymptomatic nasopharyngeal carriage of meningococci is of short duration and resolves within several weeks. In a few persons, meningococci invade the circulation and cause clinical disease.

### ► Host immunity

The presence of meningococci in the nasopharynx induces a humoral antibody response, and most people acquire immunity to meningococcal disease by age of 20 years. Maternal antibodies provide protection to infants for the first 3–6 months of life. Later, colonization with nonpathogenic meningococci appears to produce cross-reacting, protective antibodies.

Specific IgG antibodies are produced against meningococcal polysaccharides in combination with the complement mediate bactericidal activity against the meningococci. Individuals lacking the bactericidal antibodies and those suffering from complement deficiencies—such as C5, C6, C7, or C8 components of the complement—show increased susceptibility to meningococcal disease.

An episode of meningitis confers group-specific immunity, but a second episode may be caused by another meningococcal serogroup.

## Clinical Syndromes

*N. meningitidis* causes the following conditions: (a) meningitis, (b) meningococcemia, and (c) other syndromes.

### ► Meningitis

Meningococcal meningitis caused by *N. meningitidis* is most common in children and young adults. It is a febrile illness of short duration characterized by headache and stiff neck. Lethargy or drowsiness is frequent. Confusion, agitated delirium, and stupor are rarer. Mental obtundation, stupor, and coma due to increased intracranial pressure are some of the noted complications at the end stage of the disease.

Prognosis of meningitis is good, and the patients recover completely on immediate treatment with appropriate antimicrobial therapy. However, prognosis is bad in comatose patients and in patients with local neurological findings.

### ► Meningococcemia

Meningococcemia with or without meningitis is a life-threatening condition. The condition presents as an acute fever with petechial rash. Small petechial rashes are continuously found on the trunk and lower extremities; subsequently the rashes may coalesce to form large hemorrhagic lesions.

*Waterhouse–Friderichsen syndrome* is an overwhelming systemic infection caused by *N. meningitidis*. This condition is characterized by severe disseminated intravascular coagulation, shock, and multisystem failure including destruction of adrenal glands. The condition, associated with circulatory collapse with intravascular coagulation, is invariably fatal. It is most commonly seen in persons suffering from deficiency of C5–C9 components of the complement. The vascular damage seen in this condition is caused primarily by the action of LOS endotoxin present in the meningococci.

### ► Other syndromes

Nonsuppurative arthritis, usually of the knee joint, is seen in approximately 10% of the patients with meningococcal disease. This condition is observed within the first 48 hours of treatment and is believed to be immunologically mediated.

Recurrent meningococcal meningitis is another condition which is associated with hereditary deficiency of various components of complement system.

Other conditions include meningococcal pneumonia (which probably results from the aspiration of the organisms), septic arthritis, purulent pericarditis, and endophthalmitis.

## Epidemiology

### ► Geographical distribution

Meningococcal disease occurs worldwide. *N. meningitidis* serogroup A usually causes epidemics, serogroup B causes both epidemics and outbreaks, while serogroup C mostly causes localized outbreaks. Endemic meningitis is more common in children below the age of 5 years and in elderly people. Large outbreaks of meningococcal disease have occurred in central African countries with attack rate as high as 400–500 cases per 100,000 population. Epidemics of meningococcal disease have occurred in many parts of the world.

Meningococci of group A are associated with diseases in underdeveloped countries; meningococci of group B, C, or Y are responsible for most (90%) of the cases of meningococcal diseases in the developed countries (Table 26-5).

### ► Habitat

*N. meningitidis* is primarily a pathogen of humans. Meningococci are found in the nasopharynx and oral cavity. Asymptomatic carriage of *N. meningitidis* varies from as low as 1% to as high as 40% in the population. The carriage rates are highest in school-going children, in young adults, and in the population with low economic status.

TABLE 26-5

**Epidemiology of *Neisseria meningitidis* serogroups**

Serogroups	Disease
A	Meningococcal disease in underdeveloped countries
B	Meningitis and meningococemia; most (>90%) cases of meningitis in developed countries
C	Meningitis and meningococemia; most (>90%) cases of meningitis in developed countries
Y	Meningococcal pneumonia
W135	Meningococcal pneumonia

**Reservoir, source, and transmission of infection**

Human is the only reservoir of meningococcal infection. Nasopharyngeal secretion is the most common source of infection. Meningococci are transmitted by airborne droplets of infected nasopharyngeal secretions (the most common source of infection). Family members living in crowded conditions or the people who live in close populations (such as military barracks and prisons) and older people are more susceptible to infection.

**Laboratory Diagnosis**

Laboratory diagnosis depends on demonstration of meningococci in clinical specimens by microscopy and culture.

**Specimens**

Cerebrospinal fluid and blood are the specimens of choice for demonstration of meningococci in the early stage of meningitis. Nasopharyngeal swabs are useful to detect carriers. The CSF is collected by lumbar puncture and blood by venipuncture in strict aseptic conditions. CSF is never refrigerated as *Haemophilus influenzae*, another agent of meningitis, may die at the cold temperature. CSF specimens are transported immediately to laboratory for processing. Similarly, blood is collected in blood culture media containing either glucose broth or sodium taurocholate broth. Nasopharyngeal specimens are collected using sterile swabs and are transported in Stuart's transport medium to the laboratory.

**CSF**

Meningococcal meningitis produces various inflammatory changes in the CSF:

- The CSF in bacterial meningitis is more turbid.
- It contains more than 1000 WBC/ $\mu$ L, and the cells are predominantly PMN cells.
- The total protein content is increased. The total glucose level, which is normally 60% of simultaneous blood glucose level, is lowered (hypoglycorrhachia).
- The intracranial pressure may be elevated.

CSF received in the laboratory is processed in three parts:

1. First part is centrifuged and smear is prepared from the deposit for Gram staining. The supernatant is tested for meningococcal antigens.

2. The second part of CSF is used for direct culture.
3. The third part is incubated overnight with an equal volume of glucose broth and then subcultured onto the blood agar and chocolate agar.

**Microscopy**

Gram staining of the CSF is a very useful method for detection of meningococci. Meningococci are seen as Gram-negative diplococci present mainly inside the leukocytes and some may even be present extracellularly. These cocci can be demonstrated in the CSF in approximately 50% of the patients with meningococcal meningitis. In fulminant meningococemia, Gram staining of the peripheral blood buffy coat may reveal Gram-negative diplococci.

**Culture**

Isolation of *N. meningitidis* from the CSF, blood, and other clinical specimens by culture confirms the diagnosis of meningococcal infection. The CSF is inoculated immediately on a nonselective medium, such as blood agar or chocolate agar, and incubated at 35–36°C under 5% CO<sub>2</sub> for 18–24 hours. The colonies of meningococci are small, round, translucent, and convex with a smooth glistening surface.

Blood is inoculated immediately into blood culture bottles containing either glucose broth or sodium taurocholate broth and incubated at 35–36°C. Subcultures are made on blood agar or chocolate agar from these broths and are reincubated overnight at 35–36°C in the presence of 5% CO<sub>2</sub>. The cultures should be incubated for 4–7 days with daily subculture. Blood culture is often positive during early stage of meningitis and in meningococemia.

**Other specimens**

Other specimens, such as nasopharyngeal swabs and petechial exudates are processed in a similar way as described earlier for CSF.

**Identification of bacteria**

*N. meningitidis* are identified by the characteristics listed in Box 26-2. Serogrouping of the bacterial isolates grown on culture is carried out by slide agglutination with specific hyperimmune serum.

**Antigen detection**

Detection of soluble polysaccharide antigen in the CSF is a useful method for diagnosis of meningococcal meningitis. Counter-current immunoelectrophoresis, latex agglutination test, and bacterial coagglutination test using specific antibodies are the rapid tests frequently used to detect the soluble antigen in the CSF. Antigen detection is useful when bacteria are scanty in the CSF. However, antigen detection is not useful in the meningitis caused by Group B meningococci because *N. meningitidis* serogroup B is relatively nonimmunogenic and does not react with specific antibodies.

## ► Serodiagnosis

Indirect hemagglutination test and ELISA are useful for the demonstration of antibodies against specific polysaccharide antigen in the serum. Serodiagnosis is useful in the cases of chronic meningococcal infection where cultures have proved negative for meningococci.

## Molecular Diagnosis

PCR has been used for detection of *N. meningitidis* DNA in clinical specimens. The test is useful to detect small amounts of meningococcal DNA in CSF. It is a more sensitive test for diagnosis of meningococcal meningitis than the culture. The high cost of the test and the expertise necessary to operate a PCR assay are the disadvantages of the test. The test, therefore, is only used in a large-scale outbreak when a number of specimens are to be analyzed, and in a tertiary healthcare center.

## Treatment

Prompt and specific antimicrobial therapy of meningococemia or meningococcal meningitis is most crucial. Intravenous penicillin G is the recommended drug for the treatment of meningococcal disease. The MIC of penicillin usually ranges from 0.01 to 0.05  $\mu\text{g}/\text{mL}$  against meningococcal isolates.

Chloramphenicol, rifampicin, erythromycin, tetracycline, and cephalosporins (ceftriaxone, cefotaxime, and cefuroxime) are useful in treatment of bacterial meningitis. Ceftriaxone has an additional advantage of eradicating the nasopharyngeal carriage of meningococci. Chloramphenicol is useful for patients who are allergic to penicillin.

Meningococci are not susceptible to vancomycin and polymyxin. Meningococci resistant to sulfadiazine (MIC  $\geq 0.128$   $\mu\text{g}/\text{mL}$ ) have been documented recently.

## Prevention and Control

This includes chemoprophylaxis and vaccines.

### ► Chemoprophylaxis

Antimicrobial chemoprophylaxis of close contacts is the key factor for preventing secondary cases of sporadic meningococcal disease. Person-to-person transmission can be interrupted by administration of antibiotics, which eradicate the asymptomatic nasopharyngeal carrier state. Sulfonamides, rifampin, minocycline, ciprofloxacin, and ceftriaxone are the drugs frequently used to eradicate meningococci from the nasopharynx. However, ciprofloxacin is not recommended for children, because it has been found to cause cartilage damage in immature experimental animals.

### ► Immunoprophylaxis

Immunoprophylaxis by vaccination with group-specific meningococcal capsular polysaccharides of groups A, C, Y, and W135 meningococci is very much useful for prevention of meningococcal disease.

## Vaccines

**Quadrivalent meningococcal polysaccharide vaccine (MPSV4):** It has been shown to be highly effective in preventing disease caused by A, C, Y, and W135 serogroups of meningococci. The vaccine is given intramuscularly. Use of this vaccine is indicated for population at risk during outbreak of infection caused by one of these serogroups of meningococci. These vaccines developed against group A, C, Y, and W135 are poorly immunogenic under 2 years of age. These vaccines, however, produce good antibody response in children above 2 years of age.

**Tetavalent meningococcal polysaccharide-protein conjugate vaccine (MCV4):** Recently, in 2005, MCV4 is being used for the persons aged 11–55 years for vaccination against meningococci in the United States. This is recommended for groups of population at risk, which include (a) military recruits, (b) travelers to areas hyperendemic or epidemic for meningococcal disease, (c) patients with anatomic or functional asplenia, (d) patients with terminal complement deficiency, and (e) microbiologists who are routinely exposed to meningococci. No vaccine against group B meningococci is available because group B meningococcal capsular antigen is not immunogenic. However, of late some progress has been made in preparation of vaccine for group B meningococci. The vaccine, which is at the experimental stage, consists of outer membrane proteins that are capable of inducing group-specific bactericidal antibodies.

## Other *Neisseria* Species

Other species of the genus *Neisseria* rarely cause human disease. They are found as part of normal bacterial flora mostly of the respiratory tract. These commensal *Neisseria* are *Neisseria flavescens*, *Neisseria sicca*, *Neisseria lactamica*, and *Neisseria subflava*. The commensal *Neisseria* differ from pathogenic *Neisseria* species by following properties:

- They can grow on ordinary agar not enriched with blood and serum and they can also grow at 22°C.
- They do not require high percentage of CO<sub>2</sub> for their growth.
- They produce greenish yellow or yellow colonies on the media.

*N. flavescens* and *N. sicca* have been associated with isolated cases of meningitis, osteomyelitis, acute otitis media, and acute sinusitis. But true incidence of respiratory tract infection caused by these *Neisseria* species is not known. Most of these strains are susceptible to penicillins.

*N. lactamica* is frequently isolated from the nasopharynx and is a nonvirulent *Neisseria*; however, it is closely related to pathogenic *Neisseria*.

*Neisseria catarrhalis*—which was later designated as *Branhamella catarrhalis* and is now renamed as *Moraxella catarrhalis*—is a commensal of the upper respiratory tract and, occasionally, is found in female genital tract. It is a recognized respiratory opportunistic pathogen in immunocompromised host and hospitalized people. *M. catarrhalis* is multidrug resistant and grows on ordinary media, such as nutrient agar and MacConkey agar. It causes infections (e.g., otitis media, maxillary sinusitis, meningitis, septic arthritis, endocarditis, sepsis, etc.) in immunocompromised patients and in children. Some strains are susceptible to cephalosporins, chloramphenicol, and tetracycline.

**CASE  
STUDY**

A 22-year-old female complained of lower abdominal pain on and off for the last 3 months. She complained of a feeling of heaviness in the pelvis and pain during sexual intercourse. On examination, a tender mass was found to the right side during examination. Gram staining of cervical swab showed plenty of pus cells and a few Gram-negative cocci. She gave a history of allergy to penicillins.

- Which is the most likely genital infection the patient is suffering from?
- Which is the most likely bacterium to cause this genital condition?
- What other diseases are caused by this bacterium?
- How you will confirm diagnosis of this condition in the laboratory?
- What antibiotics you can use in this patient for treatment of the condition?

# Corynebacterium

## Introduction

The genus *Corynebacterium* consists of a diverse group of bacteria including animal and plant pathogens, as well as saprophytes. Some corynebacteria are found as part of the normal flora of humans in the skin, upper respiratory tract, and urogenital tract. Corynebacteria (from the Greek words *koryne*, meaning club, and *bacterion*, meaning little rod) are Gram-positive, aerobic or facultative anaerobic, nonmotile, and catalase-positive rod-shaped bacteria. They have a cell wall with arabinose, galactose, meso-diaminopimelic acid, and short-chain mycolic acids. They do not form spores or branch as do the actinomycetes, but they have the characteristic of forming irregular-shaped, club-shaped, or V-shaped arrangements in normal growth. Gram staining shows bacteria in short chains or clumps resembling characteristic Chinese letters.

The genus *Corynebacterium* consists of 46 species, of which at least 30 species are known to be associated with human diseases. *Corynebacterium* species that can cause infections in humans are summarized in Table 27-1. *Corynebacterium diphtheriae*, the causal agent of the disease diphtheria is the most widely studied species. Nondiphtherial corynebacteria—collectively referred to as diphtheroids—originally were believed to be mainly contaminants. These diphtheroids have recently been recognized as pathogenic, especially in immunocompromised hosts.

## *Corynebacterium diphtheriae*

*C. diphtheriae* is the most important species causing diphtheria. Diphtheria is an acute upper respiratory tract illness characterized by sore throat, low-grade fever, and an adherent membrane on the tonsil(s), pharynx, and/or nose.

## Properties of the Bacteria

### ► Morphology

*C. diphtheriae* shows following features:

- *C. diphtheriae* is a Gram-positive bacillus showing maximum pleomorphism on Gram staining.
- The bacteria characteristically appear in palisades or as individual cells lying at sharp angles to each other in V and L formation. This *Chinese letter pattern* formation or *cuneiform arrangement* is caused by the incomplete separation of the daughter cells during division when the organism is grown on nutritionally inadequate media, such as coagulated egg medium or Loeffler's coagulated serum.
- The bacterium measures  $3-6 \times 0.6-0.8 \mu\text{m}$  and is slender and sometimes has swollen ends.
- Most of the bacteria have 2-3 granules at the swollen ends, which give reddish purple color when stained with Loeffler alkaline methylene blue. Rest of the bacterium is unevenly stained with the dye.

TABLE 27-1

Human infections caused by *Corynebacterium* species

Bacteria	Diseases
<i>Corynebacterium diphtheriae</i>	Diphtheria (respiratory and cutaneous); diphtheria of other sites (external ear, the eye) and the genital mucosa; pharyngitis, and endocarditis
<i>Corynebacterium ulcerans</i>	Cutaneous infections; diphtheria-like lesions, such as pharyngitis and respiratory disease
<i>Corynebacterium jeikeium</i> (group JK)	Wound infections, septicemia, foreign body (catheter, prosthesis) infections, and endocarditis
<i>Corynebacterium urealyticum</i> (group D2)	Urinary tract infection
<i>Corynebacterium pseudotuberculosis</i>	Native and prosthetic valve endocarditis, pneumonia, lung abscesses, tracheobronchitis, and suppurative lymphadenitis
<i>Corynebacterium haemolyticum</i>	Pharyngitis
<i>Corynebacterium striatum</i>	Respiratory tract infections and foreign body infections
<i>Corynebacterium pseudodiphtheriticum</i>	Pneumonia, lung abscesses, tracheobronchitis, endocarditis, and lymphadenitis

- The granules are also known as *metachromatic granules*, *Babe-Ernest's granules*, or *volutin granules*. These granules, which are the accumulation of polymerized phosphates, are responsible for the beaded appearance of the bacteria. The granules can be demonstrated by special staining techniques, such as Albert stain, Neisser stain, and Ponder stain.
- They are nonmotile and nonsporing.

### ► Culture

*C. diphtheriae* is an aerobic and facultative anaerobic organism but grows best under aerobic conditions. It grows at 37°C and at a pH of 7.2–7.4 on media enriched with blood, serum, or egg.

1. **Loeffler's serum slope:** Loeffler's serum slope is an enriched medium frequently used for the growth of *C. diphtheriae*. The characteristic morphology of the bacteria is best seen on Loeffler's serum slope. The bacteria, on this medium, produce a luxuriant growth in 6–8 hours at a temperature of 37°C. Initially, the colonies are small, circular, opaque, and white, but on prolonged incubation the colonies become larger in size and show a distinct yellow tint. Loeffler's serum slope does not support the growth of streptococci and pneumococci.
2. **MacLeod's or Hoyle's tellurite blood agar** media are the examples of selective media used for the culture of *C. diphtheriae*. Tellurite (0.04%) present in the media inhibits growth of other contaminant bacteria. Most strains of the bacteria require nicotinic and pantothenic acids for their growth; some also require thiamine, biotin, or pimelic acid. For the optimal production of diphtheria toxin, it is essential to supplement the medium with amino acids and a source of iron. On the tellurite agar, *C. diphtheriae* produces characteristic gray or black colored colonies after 48 hours of incubation (Fig. 27-1, Color Photo 23). *C. diphtheriae* reduces tellurite to metallic tellurium, which is incorporated in the colonies, thereby giving them a characteristic gray or black color.

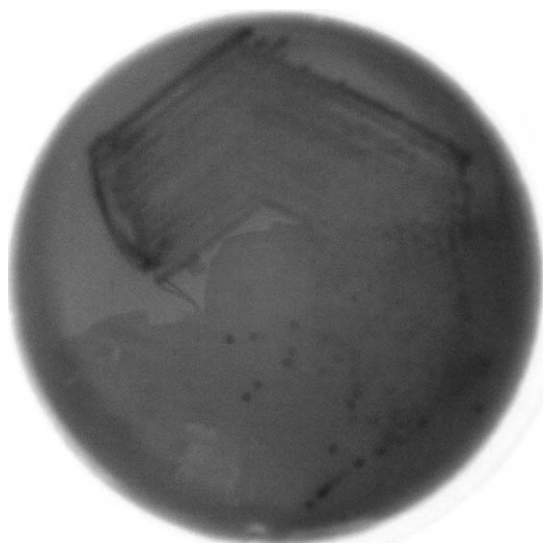

**FIG. 27-1.** Potassium tellurite agar showing black colonies of *Corynebacterium diphtheriae*.

**TABLE 27-2**

### Salient features of various biotypes of *Corynebacterium diphtheriae*

Features	Gravis	Intermedius	Mitis
<b>Size</b>	Short rods	Long rods	Long curved rods
<b>Pleomorphism</b>	+	+++	++++
<b>Granules</b>	Few or no	Few	Prominent
<b>Staining reaction</b>	Uniform	Irregular	Irregular
<b>Colony</b>	Daisy head	Frog's egg	Poached egg
<b>On tellurite agar</b>			
Surface	Malt	Shining	Glossy
Consistency	Brittle	Weak buttery	Buttery
Hemolysis	Variable	Nonhemolytic	Hemolytic
<b>Starch fermentation</b>	+	–	+
<b>Phage types</b>	14	3	4
<b>Toxicogenicity of strains</b>	95%	99%	85%
<b>Antigenic types</b>	13	4	40
<b>In broth medium</b>	Pellicle formation and granular deposits	No pellicle, Granular deposit	Diffuse turbidity

*C. diphtheriae* is classified into three distinct biotypes (mitis, intermedius, and gravis) based on the colony morphologies on cysteine-tellurite agar (Table 27-2):

- **Mitis** colonies are small, round, convex, and black.
- **Intermedius** colonies are small, flat, and gray.
- **Gravis** colonies are large, irregular, and gray.

These morphological types of the strains were initially correlated with severity of the disease. Mitis strains were thought to produce mildest variety, gravis to produce the most serious disease, while the intermedius to produce the disease of intermediate severity, but now these distinctions are not considered valid. These morphological types, however, are useful for the epidemiological classification of *C. diphtheriae* isolates.

### ► Biochemical reactions

*C. diphtheriae* shows the following reactions:

- *C. diphtheriae* ferments many sugars (glucose, galactose, maltose, and dextrin) producing acid but no gas. Hiss's serum water is always used for testing fermentation of sugars.
- The bacteria do not ferment lactose, mannitol, and sucrose. Some strains of virulent *C. diphtheriae* ferment sucrose. They do not hydrolyze urea or form phosphatase and they lack proteolytic activity.

### ► Other properties

**Susceptibility to physical and chemical agents:** Diphtheria bacilli are readily killed by heating at 58°C for 10 minutes and at 100°C for 1 minute. They are destroyed by the usual strengths of antiseptics. They are resistant to the action of

light, desiccation, and freezing. They remain fully virulent and viable in floor dusts and in blankets even for up to 5 weeks.

## Cell Wall Components and Antigenic Structure

The cell wall contains neuraminidase, arabinose, galactose, mannose, corynemycolic acid, and corynemycolenic acid. The cell walls of the diphtheria bacilli are antigenically heterologous.

## Pathogenesis and Immunity

Diphtheria is a classic example of toxin-mediated bacterial disease.

### Virulence factors

Diphtheria toxin, the exotoxin produced by *C. diphtheriae*, is the key virulence factor of the bacteria (Table 27-3).

**Diphtheria toxin:** Diphtheria toxin is produced only by strains of *C. diphtheriae* that are lysogenized with bacteriophages that contain the structural gene (*tox gene*) for the toxin molecule (*tox+* strains). When DNA of the phage becomes integrated into the genetic material of *C. diphtheriae*, the bacteria develop the capability of producing the polypeptide toxin. The gene for toxin production occurs on the chromosome of the prophage, but a bacterial repressor protein controls the expression of this gene. The repressor is activated by iron, and it is in this way that iron influences toxin production. High yields of toxin are synthesized only by lysogenic bacteria under conditions of iron deficiency.

### Key Points

- Diphtheria toxin is a powerful exotoxin, as little as 1–10 millionths (i.e., 0.0000001) of a gram can cause death in a guinea pig weighing 250 g in 96 hours.
- It is a protein with a molecular weight of 58,000 Da.
- It is synthesized in precursor form on membrane-bound polysomes in *C. diphtheriae* and is cotranslationally secreted as a single polypeptide chain made up of 535 amino acids. When released, the native toxin molecule is nontoxic until exposure of the active enzymatic site to mild trypsin treatment.
- The biologically active molecule consists of two functionally distinct polypeptide chain fragments A (24,000-Da protein) and B (38,000-Da protein), linked by a disulfide bridge. Neither of the fragments are toxic on their own, but act together to cause toxicity.
- Intradermal inoculation of toxigenic culture or toxin causes local erythematous lesion within 48 hours.
- In animals, toxin causes congestion of adrenal glands with scattered hemorrhages in medulla or cortex or both. Regional lymph nodes as well as internal organs are also congested.

TABLE 27-3

### Virulence factors of *Corynebacterium diphtheriae*

Virulence factors	Biological functions
Diphtheria exotoxins	Neuro and cardiotoxin; inhibits protein synthesis by inactivating elongation factor

### Pathogenesis of diphtheria

*C. diphtheriae* usually enters the body through the upper respiratory tract but can also enter through the skin, genital tract, or eye. Infection begins by adherence of the bacteria at the infected site. The initial lesion usually occurs on the tonsils and oropharynx, and from this site it may spread to the nasopharynx, larynx, and trachea. The organisms multiply rapidly in the epithelial cells, forming a local lesion and secrete exotoxins that cause necrosis of the cells in that area. The combination of cell debris and exudative inflammatory response (leading to accumulation of red blood cells, necrosed cells, bacteria, fibrin, and lymphocytes) result in the formation of the characteristic pseudomembrane. The pseudomembrane of diphtheria is thick, leathery, grayish-blue or white. The membrane adheres very tenaciously to the underlying mucosa and if attempts are made to forcibly remove it, raw bleeding surface is exposed. Spreading of the membrane down the bronchial tree can occur, causing respiratory tract obstruction and dyspnea.

Growth of *C. diphtheriae* is restricted to oral cavity, but toxemia and systemic manifestation of diphtheria occurs due to absorption of toxin from the site of membrane. The toxin binds to a specific receptor (now known as the HB-EGF receptor) present on susceptible cells and enters by receptor-mediated endocytosis (Fig. 27-2). Apparently as a result of activity on the endosomal membrane, the A subunit is cleaved and released from the B subunit. Fragment A then gains entry into the cell and catalyzes ADP ribosylation. This leads to the inhibition of the NAD in protein synthesis. Ultimately, inactivation of all the host cell EF-2 molecules causes cell death, which clinically manifests as the necrotic lesion of diphtheria. Diphtheria toxin:

- Causes local tissue destruction at the site of membrane formation (the upper respiratory tract), facilitating replication and transmission.
- Is also absorbed into the blood stream and distributed, resulting in systemic complications of diphtheria including demyelinating peripheral neuritis and myocarditis.

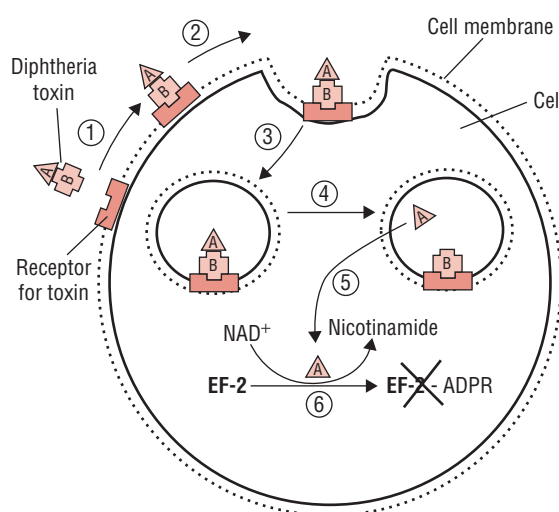

FIG. 27-2. Cellular mechanism of *Corynebacterium diphtheriae* toxin.

*C. diphtheriae* does not cause any invasion of the blood to produce systemic manifestation of the diphtheria.

### ► Host immunity

In diphtheria, immunity against clinical diseases depends on the presence of antitoxin in the blood stream, in response to clinical or subclinical disease or active immunization. Infants below 6 months of age carry IgG antibodies derived from the immune mother either transplacentally or through breast-feeding. The antibodies later developed are IgG and IgA type. In areas where diphtheria is endemic and mass immunization is not practiced, most young children are highly susceptible to infection.

Individuals who have fully recovered from diphtheria may continue to harbor the organisms in the throat or nose for weeks or even months. In the past, it was mainly through such healthy carriers that the disease was spread, and toxigenic bacteria were maintained in the population. The immune status of the individuals is assessed by the presence of antitoxin levels or by Schick's test.

**Schick's test:** Schick's test was introduced by Schick in 1913 to assess the immunity among children. The test is performed by injecting 0.1 mL of highly purified toxin (1/50 minimum lethal dose) into one forearm and 0.1 mL of heat-inactivated toxin into another forearm as a control. This brings about four types of reactions: (a) positive reaction, (b) negative reaction, (c) pseudoimmunereaction, and (d) combined reaction.

- 1. Positive reaction:** This is characterized by a local inflammatory reaction that reaches maximum intensity in 4–7 days in the test arm and then reduces gradually. This indicates absence of immunity to *C. diphtheriae*.
- 2. Negative reaction:** Absence of any inflammatory reaction is suggestive of a negative reaction. This indicates the presence of antitoxin in the individual, which neutralizes the toxin injected. Such an individual is immune to *C. diphtheriae* infection.
- 3. Pseudoimmunereaction:** In endemic areas, allergy to the toxin is seen among children and adults. Even though the individual is immune, yet an allergic reaction is observed in both the test as well as the control arm. The inflammatory reaction reaches its peak in 36 hours and subsides in 72 hours in both the arms. This reaction is called *pseudoimmune reaction* and it indicates that the individual is immune but hypersensitive.
- 4. Combined reaction:** This is the condition in which an individual injected with the toxin develops inflammation in the test arm, which increases in intensity by 4–7 days. In the control arm, the inflammation is seen for a maximum of 48–72 hours and then subsides. It indicates the individual is not immune and is hypersensitive.

### Clinical Syndromes

The clinical manifestations of diphtheria depend upon the following: (a) immune status of the patient, (b) virulence of the bacteria, and (c) the site of the infection. Toxigenic strains (tox+) of *C. diphtheriae* cause:

- Serious, sometimes fatal, disease in nonimmune patients.
- Mild respiratory diseases in partially immune patients.
- Asymptomatic colonization in fully immune individuals.

Nontoxigenic strains (tox–) cause a mild disease, such as cutaneous diphtheria.

### ► Respiratory diphtheria

Incubation period varies from 2 to 5 days. Sore throat, in the absence of systemic complaints, is the usual initial symptom. Fever, if occurs, is usually lower than 102°F, and malaise, dysphagia, and headache are frequently present. Respiratory diphtheria is:

- Characterized by the formation of a fibrinous pseudomembrane on the palate, pharynx, epiglottis, larynx, or trachea and may extend to the tracheobronchial tree. The pseudomembrane is generally a firmly adherent, thick, fibrinous, gray-brown membrane. This membrane may cause bleeding if disturbed. Respiratory distress may occur if the membrane breaks loose and occludes the airways.
- Associated with marked edema of the tonsils, uvula, submandibular region, and anterior neck (*bull neck*).

Complications of respiratory diphtheria include the following:

- Myocarditis—the main complication, which may occur in as many as two-thirds of the patients.
- Circulatory collapse, heart failure, atrioventricular blocks, and dysrhythmias may also occur.
- Involvement of the cranial nerves (leading to paralysis of the soft palate with resultant difficulty in swallowing and nasal regurgitation of the fluids) and polyneuritis of the lower extremities. Recovery is complete in both cases.

### ► Cutaneous diphtheria

Cutaneous diphtheria is generally caused by nontoxigenic strains (tox– strains) of *C. diphtheriae*. The condition is an indolent nonprogressive infection characterized by a superficial, nonhealing ulcer with a gray-brown membrane. The condition may occur at one or more sites—usually confined to the areas with previous mild trauma or bruising. Extremities are affected more often than the trunk or head. Pain, tenderness, erythema, and exudate are the typical presentations. Respiratory tract colonization or symptomatic infection and toxic complications occur in a minority of patients with cutaneous diphtheria. Cutaneous diphtheria may persist for weeks to months. Cutaneous diphtheria often causes no toxicity while producing natural immunity; however, it may cause epidemics in poorly immunized populations.

### ► Diphtheria of other sites

External ear, eye (usually the palpebral conjunctivae), and genital mucosa are the other sites of diphtheria. Rare sporadic cases of endocarditis usually due to nontoxigenic strains have been reported. Septicemia caused by *C. diphtheriae* is rare but is invariably fatal.



## Epidemiology

### ► Geographical distribution

During the early 1990s, diphtheria was still endemic in many parts of the world including the Indian subcontinent, Indonesia, Philippines, Brazil, Nigeria, and republics of the former Soviet Union.

- The largest outbreak of diphtheria in the developed world occurred from 1990 to 1996 throughout the states of the former Soviet Union. Most cases were reported among adolescents and adults, rather than children. More than 110,000 cases of diphtheria and 2900 fatalities from diphtheria were reported during the epidemic. Incidence declined in 1996, possibly due to immunization and early detection activities that were carried out following the outbreak.
- Outbreaks have also been reported in Central Asia, Algeria, and Ecuador. In the United States, Europe, and Eastern Europe, recent outbreaks of diphtheria have occurred largely among alcohol and/or drug abusers.
- Since 1994, with the advent of active immunization procedures, case fatality due to diphtheria has reduced significantly.

### ► Habitat

The upper respiratory tract of an infected host is the primary habitat of *C. diphtheriae*. The bacteria also inhabit the superficial layers of the skin lesions.

### ► Reservoir, source, and transmission of infection

Humans are the only natural host of *C. diphtheriae* and thus are the only significant reservoirs of infection. Infective droplets or nasopharyngeal secretions are the common sources of infection.

- Direct human contact facilitates transmission of the disease. Patients with active infection are more likely to transmit diphtheria.
- *C. diphtheriae* is most commonly transmitted by close contacts through droplets of nasopharyngeal secretions or infected skin lesions.
- It is known that toxigenic strains may directly colonize the nasopharyngeal cavity. In addition, the tox gene can be spread indirectly by the release of toxigenic corynebacteriophage and by lysogenic conversion of nontoxigenic autochthonous *C. diphtheriae in situ*. Asymptomatic respiratory carrier states are believed to be important in transmitting diphtheria and immunization appears to reduce the likelihood of carrier state. Dust and clothing also may contribute to the transmission. The organism can survive up to 6 months in dust and fomites.

When diphtheria was endemic, the disease was most commonly seen in children younger than 15 years, but recently, the epidemiology has shifted to adults because this group of population lacked natural exposure to toxigenic *C. diphtheriae* in the vaccine era and also received less booster doses. In serosurvey in the

United States and other developed countries, such as Sweden, Italy, and Denmark, 25% to more than 60% of adults did not show protective antitoxin levels in their serum with particularly low levels found in elderly persons.

### ► Typing

*C. diphtheriae* strains are classified into various serotypes by agglutination reactions. Mitis strains have been classified into 40 types, intermedius into 4 types, and gravis into 13 types. Gravis type II strains are found worldwide, while types I and III are commonly found in Great Britain. Type IV is mainly found in Egypt, while type V in the United States.

Typing of *C. diphtheriae* strains can also be done by biotyping, lysotype, and by using molecular biology techniques. The latter includes techniques, such as restriction endonuclease digestion patterns of *C. diphtheriae* chromosomal DNA and genetic probe for cloned corynebacterial insertion sequences.

## Laboratory Diagnosis

Initial treatment of diphtheria is based on the high clinical suspicion or the clinical diagnosis of the condition. Treatment is started without waiting for the result of the laboratory test because definitive results take as long as a week. Hence, laboratory diagnosis is carried out not for treatment of individual cases, but for the epidemiological purposes and for the initiation of control measures of the disease.

### ► Specimens

These include swabs from the nose, throat, pieces of pseudomembrane, if possible even from beneath the membrane, biopsy tissue, etc. At least two swabs from the infected site are obtained. The first swab is used to make a direct smear and the other is used for the culture.

The specimens are collected as soon as possible when diphtheria is suspected, even if treatment with antibiotics has been started. These are then transported to the laboratory in a sterile empty container or in silica gel sachets for immediate processing.

### ► Microscopy

Gram staining of the smear shows Gram-positive bacilli. Albert, Neisser, or Ponder stain of direct smears shows metachromatic granules (Fig. 27-3). However, diphtheria bacilli may not always be demonstrated in the smears, and also it may be difficult to differentiate the bacilli from those of commensal corynebacteria frequently found in the throat. Hence, staining of the smears alone is not specific to *C. diphtheriae*. The smear examination, however, is valuable to identify Vincent's spirochetes and fusiform bacilli, the causative agents of Vincent's angina.

### ► Culture

Culture of specimens for *C. diphtheriae* is essential to confirm the diagnosis of diphtheria. The specimens are inoculated on nonselective media (e.g., blood agar) as well as on selective

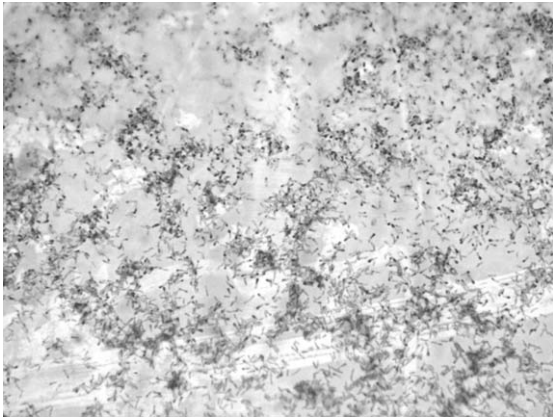

**FIG. 27-3.** Albert-stained smear showing granules of *Corynebacterium diphtheriae* ( $\times 1000$ ).

media (e.g., tellurite agar) or enriched media (e.g., Loeffler, Hoyle, Mueller, or Tinsdale medium).

Tellurite medium is very useful for isolation of *C. diphtheriae* from contacts, carriers, and convalescents, in which clinical specimens contain a number of other bacteria. The bacteria on tellurite medium produce characteristic black to grayish black colored colonies after 48 hours of incubation.

On Loeffler's serum slope, *C. diphtheriae* grows after 4–6 hours at 37°C producing small, circular, and white opaque colonies. If no colonies are seen, the medium is reincubated further for 24 hours.

### ► Identification of bacteria

The identifying features of *C. diphtheriae* colonies are summarized in Box 27-1.

- *C. diphtheriae* may be identified as mitis, intermedius, or gravis biotype on the basis of their (a) growth characteristics on tellurite medium, (b) carbohydrate fermentation patterns, and (c) hemolysis on sheep blood agar plates.
- Potentially toxigenic species (e.g., *C. diphtheriae*, *Corynebacterium ulcerans*, *Corynebacterium pseudotuberculosis*) have cystinase, but no pyrazinamidase activity.
- More recently, 16S ribosomal ribonucleic acid (rRNA) probes have been designed for the identification of genus and species of corynebacteria.

#### Box 27-1 Identifying features of *Corynebacterium diphtheriae*

1. Gram-positive, nonmotile, nonsporing bacilli showing a Chinese letter pattern formation or cuneiform arrangement.
2. On blood agar, produce variable hemolysis depending on whether it is mitis, intermedius, and gravis.
3. Ferment serum sugars, such as glucose, galactose, maltose, and dextrin, producing acid but no gas.
4. Demonstrate cystinase, but not pyrazinamidase activity.
5. Toxins are demonstrated by *in vivo* tests (e.g., subcutaneous and intradermal tests in guinea pigs) and *in vitro* test (e.g., Elek's gel precipitation test).

### ► Toxigenicity testing

All strains of *C. diphtheriae* are tested for production of toxins. Production of toxins can be demonstrated by the following tests:

1. *In vivo* test
  - (a) Subcutaneous test
  - (b) Intradermal test
2. *In vitro* test
  - (a) Elek's gel precipitation test
  - (b) Tissue culture test
3. Molecular diagnosis

#### *In vivo* test

**Subcutaneous test:** In this test, growth from overnight culture of *C. diphtheriae* on Loeffler's slope is emulsified in 2–4 mL broth. Two guinea pigs are injected subcutaneously with 0.8 mL of the emulsion. One of these is protected with 500 U of diphtheria antitoxin, which is injected intraperitoneally before 18–24 hours of the test. The other guinea pig is not protected. If the strain is virulent, the unprotected animal will die within 4 days, showing the typical findings. The protected guinea pig shall remain normal without showing any sign of toxemia.

**Intradermal test:** In this test, 0.2 mL of the emulsion obtained from 18 hours' growth of test bacteria cultured on Loeffler's serum slope is injected intradermally into shaven sites of two albino guinea pigs (or rabbits), so that each animal receives 0.1 mL into two different sites. The control animal is given 500 U of antitoxin the previous day. The other is given 50 U of antitoxin intraperitoneally 4 hours after the skin test, in order to prevent death. Toxigenicity is indicated by an inflammatory reaction at the site of injection progressing to necrosis in 48–72 hours in the test animal, and there is no change in the control animal. This method is advantageous, since large number of strains can be tested simultaneously and also the animals do not die.

#### *In vitro* test

**Elek's gel precipitation test:** The Elek's test is an immunoprecipitation test for demonstration of biological activity of the toxin, initially described in 1949. It is an *in vitro* neutralization reaction between toxin and antitoxin. The test is performed on a Petri dish containing horse serum agar. A rectangular strip of filter paper impregnated with diphtheria antitoxin (1000 IU/mL) is placed across the medium before the medium is solidified. The strain of *C. diphtheriae* to be tested for toxicity is streaked on the medium at right angles to the filter paper strip. A known toxigenic strain of *C. diphtheriae* (positive controls) and nontoxigenic strain of *C. diphtheriae* (negative control) are also inoculated along with the test strain at right angles to the strip. The plate is incubated at 37°C for 24–48 hours. After incubation, the toxin produced by the growth of the test strain diffuses into the agar and meets the antitoxin at the optimal concentration, and the line of precipitation can be seen. In strains that are negative, no precipitin lines are seen.

**Tissue culture test:** Many eukaryotic cell lines (e.g., African green monkey kidney, Chinese hamster ovary) are sensitive to diphtheria toxin, enabling *in vitro* tissue culture tests to be used for detection of toxin production. The toxigenicity of diphtheria bacilli is demonstrated by incorporating strains in agar overlay of cell culture monolayers. The toxin produced by the bacteria diffuses into the cells below and kills the cells in the monolayer.

## Molecular Diagnosis

**Polymerase chain reaction (PCR):** It is a useful test to detect toxigenic strain of *C. diphtheriae* directly in a clinical specimen. The assay allows detection of the diphtherial toxin gene (TOX) in the bacteria. Added advantage of the PCR is that it can detect nonviable *C. diphtheriae* organisms in specimens collected after starting of antibiotic therapy. The test, however, is available only in a few laboratories abroad.

## Treatment

Treatment should be started immediately after the clinical diagnosis of diphtheria. Treatment of diphtheria is based on:

1. Antitoxin therapy and
2. Antibiotics therapy

### ▶ Antitoxin therapy

**Diphtheria antitoxin:** It is the mainstay of therapy in diphtheria. Diphtheria antitoxin is a hyperimmune antiserum produced in horses, which is administered to neutralize the toxin responsible for diphtheria. The antitoxin neutralizes only free toxin before the toxin enters the cells, but is ineffective after toxin has entered into the cell.

The dosage of antitoxin is dependent on the site of infection, patient's clinical picture, and duration of illness. The antiserum appears to be more effective in less severely ill patients and in those who are treated earlier in the course of their disease. Therefore, more severely ill patients and those with longer duration of symptoms are given higher doses than those with less severe disease of shorter duration.

The dosage recommended is 20,000–100,000 U depending on the severity of the infection. The antitoxin is usually administered by the intravenous route with infusion over 30–60 minutes.

- Antitoxin appears to be of no value in treatment of cutaneous diphtheria.
- The antitoxin is also not recommended for treatment of asymptomatic carriers.

### ▶ Antibiotics therapy

Antimicrobial therapy is useful in treatment of diphtheria. Antibiotics:

- Limit the production of toxin,
- Eradicate diphtheria bacteria from infected hosts, and
- Prevent transmission of the bacteria to patient contacts.

Penicillin and erythromycin are the only antibiotics recommended for treatment. Both antibiotics are equally effective in resolving fever and local symptoms; however, erythromycin has been shown to be marginally superior in eradicating the carrier state.

- Antibiotic therapy, however, is not a substitute for antitoxin therapy.
- Elimination of the bacteria is demonstrated by at least two successive negative nose and throat cultures or skin culture obtained 24 hours' apart, after the completion of the therapy. Treatment with erythromycin is repeated if culture results remain positive.

## Prevention and Control

### ▶ Active immunization

Active immunization by vaccination with diphtheria toxoid is the key in preventing diphtheria. Vaccines consist of microorganisms or cellular components that act as antigens. Administration of the vaccine stimulates the production of antibodies with specific protective properties. Serum antitoxin concentration of 0.01 IU/mL is usually accepted as the minimum protective level, and 0.1 IU/mL provides a definitely protective level.

- Vaccination is important, especially for high-risk groups (such as children, elderly individuals, and immigrants from areas of continued endemic infections).
- Active immunization by vaccination increases resistance to *C. diphtheriae* infection. Vaccines consist of microorganisms or cellular components that act as antigens.

## Vaccines

**DTP vaccines:** It is typically combined with tetanus toxoid and acellular pertussis (triple DTaP vaccine) and is the vaccine of choice for children aged 6 weeks to 6 years. Alum-adsorbed combination toxoid vaccine against diphtheria is available. There are three types of preparation:

1. DTP (with tetanus toxoid and pertussis vaccine).
2. DTaP (with tetanus toxoid and acellular pertussis vaccine).
3. DT and Dt (with tetanus toxoid for adult and pediatric use, respectively).

Diphtheria toxoid is prepared by treating the exotoxin with formaldehyde. This treatment inactivates the toxic effects but maintains the antigenicity. Alum is used as an adsorbent, which also acts as an adjuvant and increases the immunogenicity of the vaccines. The vaccine in children and adults is usually administered in the deltoid or mid-lateral thigh muscles. Preferred site of administration in infants is the lateral part of the thigh.

The schedule of primary immunization for infants and children consists of:

- The first three doses of DTP be separated by a minimum of 4 weeks.
- The fourth dose, given 1 year after the third dose.
- A booster dose, given at the age of 4–6 years. A booster dose once in every 10 years is also recommended.

For adults and in children older than 7 years, a lower dose of diphtheria toxoid (Td) is the vaccine of choice and primary series comprises of three doses. The vaccine:

- Decreases local tissue spread of *C. diphtheriae*,
- Prevents toxic complications,
- Diminishes transmission of *C. diphtheriae*
- Provides herd immunity when at least 70–80% of a population is immunized.

However, the vaccine does not prevent subsequent respiratory or cutaneous carriage of toxigenic *C. diphtheriae*.

### ▶ Passive immunization

Passive immunization is carried out by antidiphtheric serum (ADS). This consists of administration of 500–1000 U of ADS given subcutaneously, and ADS is usually recommended as emergency measure for treatment of susceptible persons. It is most effective in reducing the fatality rate. The long half-life of specific antitoxin in the circulation is an important factor in ensuring effective neutralization of diphtheria toxin. However, to be effective, the antitoxin must react with the toxin before it becomes internalized into the cell.

### ▶ Combined immunization

Combined immunization is carried out by simultaneous administration of ADS and diphtheria toxoid. The ADS is given in one arm, while the toxoid is given in the other arm, followed by a complete schedule of vaccination with toxoid.

## Other Pathogenic *Corynebacterium* Species

### *Corynebacterium ulcerans*

*C. ulcerans* usually causes skin infections but occasionally is associated with diphtheria-like lesions, such as pharyngitis and respiratory disease. It resembles *C. diphtheriae* gravis type, but differs from it by (a) reducing nitrate to nitrite, (b) liquefying gelatin, and (c) fermenting trehalose. *C. ulcerans* produces two types of toxins: one resembles that of *C. diphtheriae* and other resembling that of *C. pseudotuberculosis*. *C. ulcerans* is also pathogenic for animals. The bacteria can cause infection in cows, and it can be transmitted to humans through milk. Antidiphtheria toxin confers protection against the infection caused by *C. ulcerans*.

### *Corynebacterium jeikeium* (Group JK)

*C. jeikeium* can colonize the skin of healthy people. Patients with prolonged hospitalization, neutropenia, or on a prolonged course of antibiotics are more susceptible to colonization by the bacteria. *C. jeikeium* is an opportunistic pathogen in immunocompromised patients with hematological disorders or intravascular catheters. The bacteria enter through the catheters and cause infections in the immunocompromised patients. In these patients, it causes

septicemia, foreign body (catheter, prosthesis) infections, and endocarditis. The bacterium is very resistant to commonly used antibiotics.

### *Corynebacterium urealyticum* (Group D2)

*C. urealyticum* is an important agent of the urinary tract infection.

- Group D2 has been reported to cause chronic or recurrent cystitis, bladder stones, and pyelonephritis.
- People with prior urinary tract abnormalities or recent urologic procedures are at highest risk for this disease.

These bacteria produce large quantities of the enzyme urease, which splits urea, producing ammonia, thereby making the urine alkaline. This leads to the formation of struvite calculi or stones. These bacteria are increasingly found in patients with immunosuppression, underlying genitourinary disorders, and in those receiving antibiotic therapy.

*Corynebacterium riegelii*, *Corynebacterium amycolatum*, and *Corynebacterium glucuronolyticum* are examples of other urease-producing *Corynebacterium* species associated with urinary tract infections.

### *Corynebacterium pseudotuberculosis*

*C. pseudotuberculosis* is closely related to *C. diphtheriae* and is also pathogenic for animals especially livestock. *C. pseudotuberculosis* is reported to be normal inhabitant of the anterior nares and skin. The bacteria colonize more on the skin of the immunocompromised patients than the healthy persons. In immunocompromised hosts, *C. pseudotuberculosis* is associated with both native and prosthetic valve endocarditis, pneumonia, lung abscesses, tracheobronchitis, and suppurative lymphadenitis. Antimicrobial resistance to antibiotics is also more common in isolates from immunosuppressed patients.

### *Corynebacterium haemolyticum*

*C. haemolyticum* causes as many as 10% of all pharyngitis cases in patients between 10 and 30 years. The bacteria produce an extracellular toxin that causes an erythrogenic rash associated with the pharyngitis.

### *Corynebacterium striatum*

*C. striatum* is found on catheters in patients with neutropenia and malignancies. The bacterium causes respiratory tract infections and foreign body infections. A case of meningitis caused by *C. striatum* has also been reported recently.

### Diphtheroids

Other *Corynebacterium* species resembling *C. diphtheriae* may sometimes be mistaken for diphtheria bacilli and are called diphtheroids or nondiphtherial corynebacteria. Diphtheroids are found as commensals in the skin, throat, conjunctiva, and other areas. They are present widely in

TABLE 27-4

Features for distinguishing *Corynebacterium diphtheriae* and diphtheroids

Characteristics	<i>Corynebacterium diphtheriae</i>	Diphtheroids
Metachromatic granules	Present	Few or absent
Staining property	Uniformly stained	More uniformly stained
Arrangement	Cuneiform arrangement	Parallel rows
Culture	Grows on enriched media	Grows on ordinary medium
Sugar fermentation	Negative	Positive
Toxins	Produce toxins	Do not produce toxins with few exceptions (e.g., <i>Corynebacterium ulcerans</i> , <i>Corynebacterium pseudotuberculosis</i> )

nature and are found commonly as part of the indigenous flora on the human skin and mucous membranes. Only recently, the role of these organisms in causing human infections has been recognized. The most common diphtheroids include *Corynebacterium xerosis* found in human conjunctival sac, *Corynebacterium pseudodiphtheriticum* found in human throat; also, these are found to be associated with human infections. Differences between *C. diphtheriae* and diphtheroids are summarized in Table 27-4.

### Other Coryneform Genera

Besides genus *Corynebacterium*, other genera of irregularly shaped, Gram-positive bacteria have been identified to colonize and cause disease in humans. The other coryneform genera include *Arcanobacterium*, *Oerskovia*, *Brevibacterium*, and *Turicella*.

- *Arcanobacterium* is associated with polymicrobial wound infection, pharyngitis, and less commonly septicemia and endocarditis. Use of penicillin or erythromycin has proved effective.
- *Oerskovia* is found in the soil and in decaying organic matter. The bacteria can cause septicemia, endocarditis, meningitis, and soft tissue infections. It shows a high degree of resistance to commonly used antibiotics.
- *Brevibacterium* has been found to colonize the skin of humans. The organism has been associated with malodorous feet in some colonized people, septicemia, osteomyelitis, and foreign body infection. These bacteria show resistance to beta-lactam antibiotics, such as erythromycin, ciprofloxacin, and clindamycin. Tetracycline, gentamicin, and vancomycin have shown to be effective.
- *Turicella* colonize the ears of the persons infected with *Turicella* and also of healthy persons. These organisms are resistant to clindamycin and erythromycin but are sensitive to ciprofloxacin and clindamycin.

### CASE STUDY

An 8-year-old child was admitted to hospital with low-grade fever (<100°F), malaise, dysphagia, and headache. Examination revealed a fibrinous membrane on the pharynx. A pair of swab collected from the membrane was sent to microbiology laboratory for diagnosis of *Corynebacterium diphtheriae*. The child was administered antitoxin by the intravenous route and treated with antibiotics. Subsequently, 3 days later the report from the laboratory confirmed isolation of a toxigenic *C. diphtheriae* from the specimen.

- Why treatment for diphtheria was started immediately without waiting for the confirmatory report?
- What are the tests performed in a microbiology laboratory to demonstrate *C. diphtheriae* in clinical specimens?
- Are nontoxigenic strains of *C. diphtheriae* capable of causing disease in humans?

# Bacillus

## Introduction

The family Bacillaceae consists of rod-shaped Gram-positive bacteria that form endospores. The family includes two main groups of spore-forming bacteria:

- The anaerobic spore-forming bacteria of the genus *Clostridium* and
- The aerobic or facultatively anaerobic spore-forming bacteria of the genus *Bacillus*.

The genus *Bacillus* is frequently known as aerobic spore bearers. They are ubiquitous and are present in soil, dust, air, and water. These bacteria are also frequently isolated as contaminants in bacteriological culture media. The genus *Bacillus* consists of more than 50 species. *Bacillus anthracis* and *Bacillus cereus* are the two most important species that cause infections in humans and animals. *B. anthracis* causes anthrax, while *B. cereus* causes food poisoning. The human infections caused by *Bacillus* species are summarized in Table 28-1.

## *Bacillus anthracis*

*B. anthracis*, the causative agent of anthrax, has a worldwide distribution. Anthrax is caused by inhalation, skin exposure, or by gastrointestinal (GI) absorption. Use of anthrax as a biological warfare agent is an additional concern now. *B. anthracis* is of considerable historical interest due to the following reasons:

1. It was the first pathogenic bacterium to be seen under microscope.
2. It was the first bacterium shown to be the cause of a disease. It was from studies on anthrax that Koch established

his famous postulates in 1876. In 1877, Robert Koch grew the organism in pure culture, demonstrated its ability to form endospores, and produced experimental anthrax by injecting it into animals.

3. It was the first bacterium to be isolated in pure culture and shown to possess spores. For the first time, spores were discovered from *B. anthracis* and *Bacillus subtilis* by Koch and Cohn and they established the germ theory of disease.
4. It was the first bacterium used for the preparation of attenuated vaccine by Louis Pasteur.

## Properties of the Bacteria

### ► Morphology

*B. anthracis* shows following morphological features:

- *B. anthracis* is a Gram-positive spore-forming bacillus.
- It is a very large bacillus measuring 1–1.2  $\mu\text{m}$  in width and 3–5  $\mu\text{m}$  in length.
- In smears from infected tissues, the bacteria are found as single, in pairs, and in short chains, the entire chain being surrounded by a capsule.
- In culture, *B. anthracis* grows as long chains and may appear similar to streptobacilli. In these chains, the bacilli are arranged end-to-end and the ends of the bacilli are truncated, not rounded, or often concave and somewhat swollen. This gives the chain of bacilli a “bamboo-stick” appearance (Fig. 28-1).
- It is capsulated. The bacterium forms the capsule only when grown on nutrient agar containing 0.7% sodium bicarbonate in the presence of 5–20% carbon dioxide. The capsule

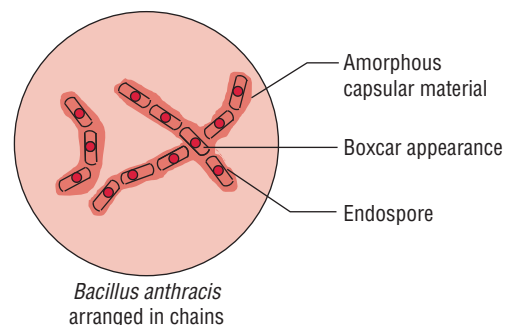

**FIG. 28-1.** A schematic diagram of *Bacillus anthracis* arranged in chains.

TABLE 28-1

### Human infections caused by *Bacillus* species

Bacteria	Diseases
<i>Bacillus anthracis</i>	Anthrax (cutaneous, gastrointestinal, and inhalational) and anthrax meningitis
<i>Bacillus cereus</i>	Gastroenteritis, intravenous catheter septicemia, and endocarditis
<i>Bacillus licheniformis</i>	Gastroenteritis
Other <i>Bacillus</i> species	Opportunistic infections

is polypeptide (polymer of D-glutamic acid) in nature. It protects the bacteria against leukocytic phagocytosis and lysis. It is usually formed in the tissues but are absent when grown in ordinary conditions of culture. It is easily visualized using a methylene blue or India ink stain. Production of the capsule is mediated by a 60-megadalton plasmid, pX02. Therefore, the transfer of this plasmid to noncapsulated *B. anthracis* by transduction makes the recipient strain capsulated.

- It is nonmotile and nonacid fast.

**Anthrax spores:** Gram staining of *B. anthracis* shows the characteristic squared ends with spores as unstained spaces. Anthrax spores are oval, central in position, and are refractile. They are of the same width as the bacillary body and so they do not cause bulging of vegetative cell. The anthrax spore consists of (a) central protoplast, (b) cortex, and (c) spore coat.

- The **central protoplast** or germ cell of the spore carries the constituents of the future vegetative cell. It also consists of dipicolinic acid, which is responsible for the heat resistance property of the spore.
- The **cortex** that surrounds the protoplast consists largely of peptidoglycan (murein), which is responsible for protecting the spore from radiation and heat. The cortical membrane, or protoplast wall, becomes the cell wall of the new vegetative cell when the spore germinates.
- The **spore coats**, which constitute up to 50% of the volume of the spore, protect it from chemicals, enzymes, etc.

The spores are highly refractile and are resistant to staining, heat, cold, radiation, desiccation, and disinfectants. Spores are formed in culture or in soil under unfavorable conditions for growth. Anthrax spores need oxygen for sporulation. These germinate when exposed to a nutrient-rich condition, such as the tissues or blood of an animal or human host. Rainfall stimulates anthrax spore germination, while flies and vultures spread the spores. Spore formation is facilitated by:

- nitrogen and organic soil content,
- environmental pH greater than 6,
- the ambient temperature greater than 15°C,
- 2% sodium chloride, and
- the presence of distilled water.

Spore formation is inhibited by calcium chloride. Spores are never found in host tissues unless the infected body fluids are exposed to ambient air.

## ► Culture

*B. anthracis* is an aerobe and facultative anaerobe. The bacteria grow at a temperature range of 12–45°C, optimum temperature being 37°C. They grow on a wide range of media including ordinary nutrient media and several selective media.

**1. Nutrient agar:** On nutrient agar after 24 hours of incubation, *B. anthracis* produces grayish and granular colonies measuring 2–3 mm in diameter. Under low-power microscopy, the edges of the colony appear as long, interlacing chains of bacilli,

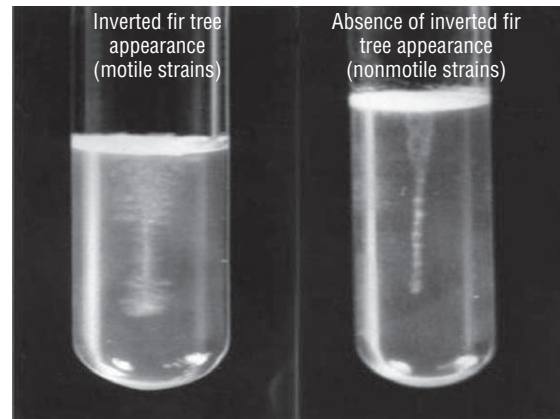

**FIG. 28-2.** Inverted fir tree appearance of colony of *Bacillus anthracis* in a gelatin stab.

resembling locks of matted hair, which gives them a “medusa head” appearance with an uneven surface and wavy margin.

**2. Blood agar:** On horse or sheep blood agar, *B. anthracis* colonies are gray or white, typically nonhemolytic, with a dry, ground-glass appearance. The colonies are at least 3 mm in diameter and sometimes have tails.

**3. Solid medium containing penicillin:** *B. anthracis* on a solid medium containing 0.05–0.5 U of penicillin/mL produces large, spherical colonies within 3–6 hours and occurs in chains on the surface of the agar, resembling a string of pearls. This property is known as **string of pearls reaction** and is useful in differentiation of *B. anthracis* from *B. cereus* and other aerobic spore bearers.

**4. Gelatin medium:** In a gelatin stab, there is growth down the stab line with lateral spikes, longer near the surface, giving an ‘inverted fir tree’ appearance. The process of liquefaction is slow and late, which occurs after 7 days at 20°C and starts at the surface (Fig. 28-2).

**5. Selective medium:** Knisely’s Polymyxin B-lysozyme-EDTA-thallos acetate (PLET) agar medium is a selective medium used for isolation of *B. anthracis* from mixtures containing other spore-bearing bacilli. The medium is composed of heart infusion agar, polymyxin, lysozyme, ethylene diamine tetra acetic acid (EDTA), and thallos acetate.

Production of capsular material is associated with the formation of a characteristic mucoid or “smooth” (S) colony type. Capsulated bacteria on serum or bicarbonate medium produce smooth or mucoid colonies. Smooth variants that form capsule are virulent strains of *B. anthracis*. Rough (R) variants that lack capsule are relatively avirulent.

## ► Biochemical reactions

*B. anthracis* shows the following reactions:

- *B. anthracis* produces acid from glucose, maltose, sucrose, trehalose and dextrin, but not from lactose, arabinose, D-xylose, or D-mannitol.
- They reduce nitrate to nitrite.

- They demonstrate a weak lecithinase reaction on egg-yolk agar, which gives a narrow zone of opalescence around the colonies.
- They are also catalase positive.

### ► Other properties

**Susceptibility to physical and chemical agents:** *Bacillus* vegetative forms are susceptible to moist heat; they are killed at 60°C in 30 minutes. *Bacillus* spores are resistant to hostile physical and chemical conditions, ranging from desert sands and hot springs to Arctic soils and from fresh waters to marine sediments. They remain viable at temperatures, pH values, and salt concentrations at which few other organisms could survive. In the dry state and in certain soils, the spores may survive for 50 years or more. They survive in 5% phenol for weeks. The spores are killed by moist heat at 100°C in 60 minutes. They are also killed by 4% (w/v) formaldehyde or 4% (w/v) potassium permanganate in a few minutes.

**Duckering:** Destruction of the spores in animal products is achieved by *duckering*. Duckering is a procedure that was used to reduce anthrax spores in wool below critical infection level without destroying the animal hairs and bristles. In this procedure, 2% formaldehyde is used at 30–40°C for 20 minutes for disinfection of wool, while 0.25% formaldehyde solution is used at 60°C for 6 hours for disinfection of animal hair and bristles.

## Cell Wall Components and Antigenic Properties

### ► Antigenic properties

Three types of antigens are present in anthrax bacillus. These are:

**Capsular antigen:** Capsular antigen is present in virulent capsulated strains of *B. anthracis*. Antibodies against capsular antigen are not protective.

**Cell wall antigen:** Cell wall antigen is present in the cell wall and is made up of *N*-acetylglucosamine and *D*-galactose. It cross-reacts with blood group A antigen and with capsular polysaccharide of type 14 *Pneumococcus*. The antibody against the cell wall antigen is not protective.

**Somatic antigen:** Somatic antigen is a heat-labile protein present in bacterial body. It stimulates immune system to produce antibodies, which are protective in nature.

## Pathogenesis and Immunity

### ► Virulence factors

Virulence of *B. anthracis* (Table 28-2) depends on the (a) bacterial capsule and (b) anthrax toxin complex.

**Bacterial capsule:** The poly-*D*-glutamyl capsule itself is nontoxic. The capsule, however, protects the organism against the bactericidal components of serum and phagocytes, and against phagocytic engulfment.

- It plays a very important role in the pathogenesis of anthrax.
- It plays most important role during the establishment of the infection.
- It plays a less significant role in the terminal phases of the disease, which are mediated by anthrax toxin.

**Anthrax toxin complex:** Anthrax toxin is an exotoxin and a protein in nature. Anthrax toxin complex comprises three components: (a) protective antigen (PA), (b) edema factor (EF), and (c) lethal factor (LF).

**Protective antigen:** The PA is an 82.7 kDa protein. It is called PA because antibodies against this antigen are protective against the action of anthrax toxin. The PA is the binding (B) domain of anthrax toxin and is necessary for entry of the bacteria into the host cell. The antigen binds to cell receptors within a target tissue. Once bound, a fragment is cleaved free to expose an additional binding site. This additional site can combine with EF to form edema toxin or with LF to form lethal toxin.

**Edema factor:** Edema factor is an 88.9 kDa protein. It is a component of the edema toxin. It is a calmodulin-dependent adenylate cyclase, which acts by converting adenosine triphosphate (ATP) to cyclic adenosine monophosphate (cAMP). This causes an increase in the cellular cAMP levels, leading to cellular edema within the target tissues. The edema factor also causes inhibition of neutrophil function and lowers the production of tumor necrosis factor (TNF- $\alpha$ ) and interleukin-6 (IL-6) by monocytes.

**Lethal factor:** LF is a 90.2 kDa protein. It is a zinc metalloprotease that inactivates mitogen-activated protein kinase, leading

TABLE 28-2

Virulence factors of *Bacillus anthracis*

Virulence factors	Biological functions
Bacterial capsule	Protects anthrax bacilli against leukocytic phagocytosis and lysis; if engulfed, resist killing and digestion
Anthrax toxin complex	Anthrax toxin complex is plasmid-encoded and comprises of the following three proteins
Protective antigen (PA)	Entry of the bacilli into the host cell. Binds the complex to receptors on macrophage surface
Edema factor (EF)	Causes cellular edema within the target tissue and also inhibits neutrophil function. Blocks adenyl cyclase pathway within cells
Lethal factor (LF)	Release of tumor necrosis factor- $\alpha$ and interleukin-1 by macrophages



to the inhibition of intracellular signaling. It stimulates the release of TNF-alpha and interleukin-1 (IL-1) by macrophages. This mechanism is thought to contribute to sudden death from toxic effects that occur in animals with high degrees of bacteremia. The local and fatal effects of the infection are due to the toxins produced by *B. anthracis*.

### ► Pathogenesis of anthrax

Spore is the infective stage of the bacilli. The median lethal inhalational dose for humans—extrapolated from data on experimental infection in monkeys—has been estimated to be 2500–55,000 spores. Spores initiate the disease process in the following ways:

- The spores, after ingestion by macrophages at the site of entry, germinate to form the vegetative forms of the bacteria.
- Virulent anthrax bacilli multiply at the site of infection with production of capsule and toxins. Phagocytes migrate to the area but the encapsulated anthrax bacilli resist phagocytic engulfment; or if engulfed, resist killing and digestion. The anthrax toxin causes further impairment of phagocytic activity and its lethal effect on leukocytes, including phagocytes, at the site.
- The activated 83-kDa PA of *B. anthracis* binds to specific receptors on the host cell surface, thereby creating a secondary binding site for which LF and EF compete and bind, leading to formation of lethal toxin and edema toxin, respectively. The lethal toxin or edema toxin is internalized by endocytosis. Subsequently, following the acidification of the endosome, the lethal toxin or edema toxin crosses the membrane into the cytosol via PA-mediated ion-conductive channels. Edema toxin produces the characteristic edema of anthrax. Subsequently, the bacteria and their toxins enter the circulation, causing systemic morbidity.
- The bacteria multiply locally and may invade the bloodstream or other organs (e.g., liver, spleen, and kidneys) via the efferent lymphatics. The presence of anthrax bacilli in the capillaries at the infection site is the characteristic finding in anthrax. The bacilli are found in the capillaries of the invaded organs, such as skin, liver, spleen, or lungs. Dissemination from the organs back into the bloodstream may result in bacteremia. In bacteremic anthrax, hemorrhagic lesions may develop anywhere on the body.

The local and fatal effects of the infection are due to the toxins produced by *B. anthracis*.

### ► Host immunity

Anthrax is primarily a disease of animals. Herbivores (e.g., cattle, sheep, and horses) are very susceptible to the infection. Rats, chicken, pigs, cats, and dogs are quite resistant to the disease. Birds, buzzards, and vultures are naturally resistant to anthrax but may transmit the spores on their talons and beaks. Humans show intermediate susceptibility to *B. anthracis*.

Animals surviving naturally acquired anthrax are immune to reinfection. Second attacks are extremely rare. Permanent

immunity to anthrax appears to be conferred by specific antibodies (*a*) to the anthrax toxins and (*b*) to the capsular polypeptide.

Antibodies against the anthrax toxin, primarily against PA, are protective.

## Clinical Syndromes

Human anthrax is of the following clinical types: (*a*) cutaneous anthrax, (*b*) gastrointestinal anthrax, (*c*) inhalational anthrax, and (*d*) anthrax meningitis.

### ► Cutaneous anthrax

Cutaneous anthrax is the most common form of anthrax and constitutes more than 95% of the naturally occurring anthrax. The condition is caused by the entry of spores through the skin lacerations, abrasions; or through fly bites, usually on the face, neck, or arms. This is commonly found in farmers and in persons handling infected carcasses. The cutaneous anthrax may progress through the following stages:

- **Papule:** The lesion begins as a painless, pruritic papule at the site of inoculation of spores. The papule, which is the primary lesion, becomes a 1–2-cm vesicle within 2 days.
- **Vesicle:** The vesicle is filled with clear or serosanguineous fluid containing numerous large, Gram-positive bacilli and very rare leukocytes. A characteristic nonpitting, gelatinous edema surrounds the lesion. The vesicle enlarges, and satellite vesicles may develop. Subsequently, the vesicle ruptures, undergoes necrosis, and enlarges, forming an ulcer covered by a characteristic black eschar (Fig. 28-3, Color Photo 25).
- **Eschar:** The skin in the surrounding areas may become edematous and necrotic, but not purulent. The name anthrax, meaning coal, comes from the eschar, which is black colored (Fig. 28-3, Color photo 25). The lesion is called “malignant pustule” due to its characteristic appearance; however, these lesions are neither malignant nor pustular. Lesions are painless, but on occasion are slightly pruritic. Occasionally, multiple bullae develop along with marked toxic effects, and the lesions especially on the face or neck



**FIG. 28-3.** Black eschar with a rim of erythema and edema: cutaneous anthrax (Courtesy: Thappa DM. *Textbook of Dermatology, Venereology and Leprology*. 2nd ed. India: Elsevier, 2005, p. 60, Fig. 6.8.).

become massively edematous. Cutaneous anthrax may resolve spontaneously with the eschar drying up and falling off in 1–2 weeks with very little scarring. Cutaneous anthrax usually remains localized. Without treatment, the condition spreads to blood and disseminates to cause systemic infection in nearly one-fifth of the cases.

Prompt antibiotic therapy prevents dissemination of the infection, but does not affect the natural history of the lesion. With treatment, the mortality due to cutaneous anthrax is approximately 1%.

### ► Gastrointestinal anthrax

The condition is caused on ingestion of undercooked meat of infected carcasses containing spores. Abdominal pain and fever are the first symptoms to appear, i.e., 2–5 days after the ingestion of the food. These symptoms are followed by nausea, vomiting, and diarrhea.

The anthrax spores invade the mucosa of the GI tract and reach mesenteric lymph nodes. The spores in lymph nodes germinate to vegetative forms and begin multiplying, causing the occlusion of the lymphatic system. This leads to ascites, hemorrhagic adenitis, and edematous stomach and intestine.

- Ulcers are the primary intestinal lesions and occur mainly in the terminal ileum or cecum.
- In some cases, necrosis and ulceration at the site of infection produces GI hemorrhage, leading to bloody diarrhea.
- Anthrax toxins can also cause renal failure.
- Without antibiotic therapy, death is rapid. Mortality is very high and is always more than 50%.

**Oropharyngeal anthrax** is a variant of intestinal anthrax and occurs in the oropharynx after ingesting meat products contaminated by anthrax. Oropharyngeal anthrax is characterized by throat pain and difficulty in swallowing. The lesion at the site of entry into the oropharynx resembles the cutaneous ulcer.

### ► Inhalational anthrax

Inhalational anthrax is also known as “*wool sorters disease*”. The condition occurs after inhaling spores into the lungs. The spores are present in the dust or in the filaments of wool from infected animals, particularly in wool factories. Spores are ingested by alveolar macrophages and are carried to the mediastinal lymph nodes. Anthrax in the lungs does not cause pneumonia, but it does cause hemorrhagic mediastinitis and pulmonary edema.

Inhalational anthrax is characteristically a biphasic illness.

- The first phase appears abruptly after an incubation period of 1–6 days. It appears as a nonspecific illness. Low-grade fever and nonproductive cough are the nonspecific pulmonary symptoms at this stage of the infection.
- After an additional 24–48 hours, the second phase of inhalational anthrax becomes apparent. The phase manifests

as high fever, shortness of breath, tachypnea, diaphoresis, and hematemesis. It progresses rapidly to characteristic hemorrhagic bronchopneumonia with shock and associated hypothermia.

Death occurs within 24–36 hours. The disease has a high fatality rate.

### ► Anthrax meningitis

Anthrax meningitis may occur commonly as a result of bacteremia from the inhalational anthrax but is a less common manifestation of the anthrax. The meninges are characteristically hemorrhagic and edematous. Cerebrospinal fluid (CSF) is typically hemorrhagic and exhibits a polymorphonuclear pleocytosis. Numerous large, encapsulated, Gram-positive bacilli are demonstrated in the CSF. Mortality is as high as 100%, but occasionally, patients treated with antibiotics have survived.

## Epidemiology

### ► Geographical distribution

Anthrax is nearly worldwide in distribution, occurring in the soil in the form of extremely resistant spores. These spores cause infection in humans and in farm and wild animals that have grazed on contaminated land or ingested contaminated food. The extent of disease is approximately 20,000–100,000 cases annually, throughout the world.

- The condition is frequently documented in the Middle East, in Africa, Asia, Latin America, and in the Indian subcontinent despite vaccination programs.
- Epidemics of human anthrax have been reported from Russia and Zimbabwe.
- Sporadic outbreaks have occurred as a result of both agricultural and military disruptions. Failure of vaccination programs in livestock led to a human epidemic, causing 6500 anthrax cases and 100 fatalities during the 1978 Rhodesian civil war. In the former Soviet Union, a mishap at a military microbiology facility resulted in at least 66 deaths in 1979.
- Anthrax is enzootic in India. An epizootic outbreak of anthrax infections in sheep has been documented in Andhra Pradesh, Tamil Nadu, and Karnataka. Many human cases of cutaneous and GI infections have been documented in these states and from other parts of the country as well.

### ► Habitat

*B. anthracis* spores are ubiquitous. They are found in the soil, water, and air.

### ► Reservoir, source, and transmission of infection

Infected animals are reservoirs of infection. Anthrax in humans is primarily zoonotic (Fig. 28-4). Infected animals or contaminated animal products (such as hides, wool, hair, and ivory tusks,

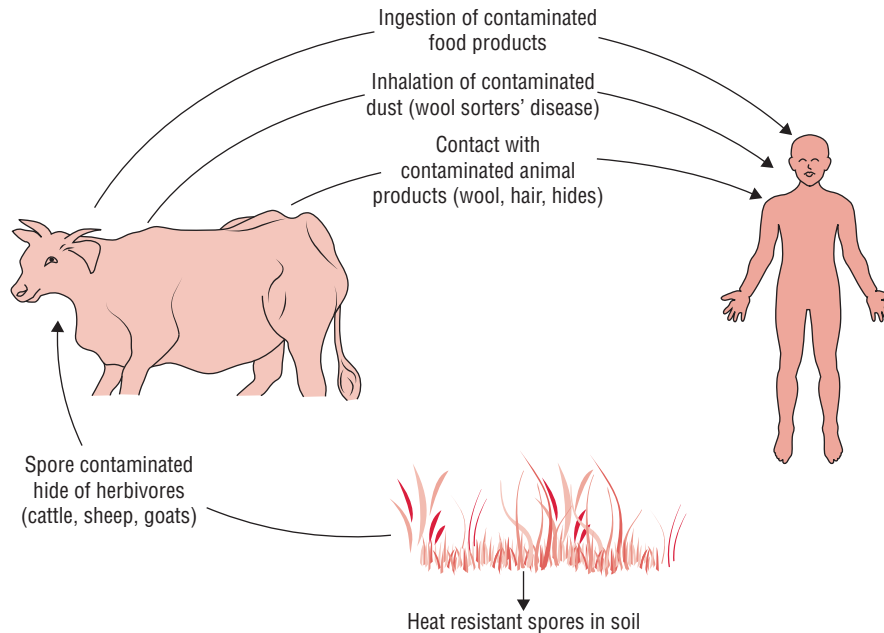

FIG. 28-4. Transmission of anthrax.

### Box 28-1 Anthrax and biological warfare

1. The possibility of creating aerosols containing anthrax spores has made *Bacillus anthracis* a chosen weapon of bioterrorism.
2. Spores of *B. anthracis* can be produced and stored in a dry form and remain viable for decades.
3. Many nations have the capability to load spores of *B. anthracis* into weapons.
4. Domestic terrorists may develop means to distribute spores via mass attacks or small-scale attacks at a local level.
5. Weapon-grade anthrax spores in bioterrorism may be dispersed as an aerosol for mass effect or by restricted spore dissemination and contamination via letters or packages.

and poorly cooked infected meat) are the important sources of infection for humans. Humans acquire anthrax infection by:

1. Close contact with infected animals or contaminated animal products, such as hides, wool, hair, and ivory tusks (**cutaneous anthrax**).
2. Ingestion of poorly cooked infected meat contaminated with anthrax spores (**GI anthrax**).
3. Inhalation of aerosolized anthrax spores associated with the large-scale processing of hides and wool in enclosed factory spaces (**inhalational anthrax**).

Inhalation of spores disseminated by terrorists an important mode of transmission in biological warfare. The possible use of anthrax spores in bioterrorism is a major concern nowadays (Box 28-1). Weapon-grade anthrax spores in bioterrorism may be dispersed as an aerosol for mass effect or by restricted spore dissemination and contamination via letters or packages. Since October 2001, 22 confirmed or suspected cases of anthrax infection have been identified in the United States.

Direct spread of the disease from humans to humans is rare. Infected animals discharge large number of bacilli from their mouth, nose, and rectum. These bacilli sporulate in the soil and remain viable over a long period of time. The contaminated soil is the important reservoir of infection for animals. Infection occurs in susceptible animals by the ingestion of the spores present in the soil.

### Laboratory Diagnosis

It is essential to follow biosafety (level II) precautions while handling clinical specimens suspected for anthrax in a microbiology laboratory.

#### ► Specimens

These include:

- Vesicular fluid, fluid from under the eschar (in cutaneous anthrax);
- Blood, lymph node, or splenic aspirates (in septicemic and inhalational anthrax);
- CSF (in anthrax meningitis); and
- Sputum and blood (in inhalational anthrax).

#### ► Microscopy

The smears are stained with Gram stain, polychrome methylene blue (McFadyean's stain), and Giemsa stain:

- Gram-stained smear of a skin lesion (vesicular fluid or eschar), CSF, or blood show encapsulated, broad, large, Gram-positive bacilli. The bacteria are found as single, in pairs, and in short chains. The bacilli do not show any spores. By Gram staining, a presumptive identification of anthrax can be done (Fig. 28-5, Color Photo 26).

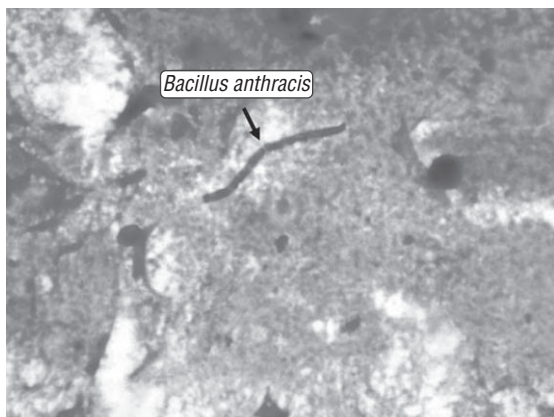

**FIG. 28-5.** Gram-stained smear shows broad large Gram-positive bacilli. Note: The bacilli do not show any spores ( $\times 1000$ ).

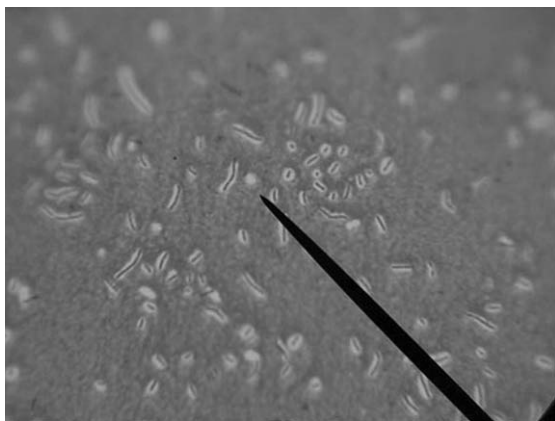

**FIG. 28-6.** Polychrome methylene blue-stained smears show an amorphous purplish material, remnant of the capsular material around the bacillus (McFadyean's reaction) ( $\times 1000$ ).

- Giemsa-stained smears show purple bacilli surrounded by red capsule.
- Polychrome methylene blue-stained smears of blood show an amorphous purplish material, remnant of the capsular material around the bacilli. This reaction is called McFadyean's reaction (Fig. 28-6) and is used for presumptive diagnosis of anthrax in animals.

## Key Points

In smears from infected tissues, the bacteria are found as single, in pairs, and in short chains, the entire chain being surrounded by a capsule. Blood smears containing anthrax bacilli stained with polychrome methylene blue show an amorphous purple material around the bacilli. This amorphous purple material represents the disintegrated capsule and is a characteristic of anthrax bacillus. This reaction is known as *McFadyean's reaction* and is used for presumptive diagnosis of anthrax (Fig. 28-6, Color Photo 24).

## ► Culture

Clinical specimens are inoculated on blood or nutrient agar or on specialized selective media for isolation of *B. anthracis*.

## Box 28-2 Identifying features of *Bacillus anthracis*

1. Macroscopic appearance of serpentine chains of bacterial colony (medusa head colony).
2. Nonhemolytic colonies on blood agar.
3. Sticky consistency of colonies on blood agar.
4. No growth on chloral hydrate agar.
5. Large, Gram-positive, spore-forming bacilli in the Gram-stained smear of the colony.
6. Nonmotile and capsulated bacteria.
7. Lysis by gamma-phage positive.
8. String-of-pearls test positive.

Knisely's PLET medium is used for selective isolation of *B. anthracis* from soil and clinical materials containing numerous other spore-forming bacteria.

## ► Identification of bacteria

Absence of hemolysis on blood agar and the formation of medusa head colonies are the characteristic features of *B. anthracis* that are used to differentiate from other closely related *Bacillus* species. The identifying features of *B. anthracis* are summarized in Box 28-2.

## ► Animal inoculation

*B. anthracis* can be isolated by collecting specimens from the contaminated tissue and applying them over the shaven skin sites of guinea pigs. The bacteria present in the specimen penetrate the skin through minute abrasions. Later, the bacilli are demonstrated in the sputum and heart blood of the guinea pigs, which die 2–3 days after the inoculation.

## ► Serodiagnosis

Serodiagnosis of anthrax is based on the demonstration of antibodies against protective antigen (PA) in the patient's serum. Gel diffusion, complement fixation, indirect hemagglutination, and enzyme linked immunosorbent assay (ELISA) are the tests used for demonstration of serum antibodies.

ELISA test has been used recently to demonstrate serum IgG against PA. The test is considered positive if a single acute-phase serum shows a high titer of antibodies or if a four-fold greater rise in the antibody titer is observed between acute and convalescent serum specimens. The test is 98.6% sensitive and 80% specific. Specific IgG anti-PA antibodies are detected as early as 10 days after the onset of symptoms, but a high IgG levels is observed only 40 days after the onset of symptom.

Ascoli's thermoprecipitation test is used mainly for rapid diagnosis when the tissue received is putrid and viable bacilli are unlikely to be found. The tissues are ground up in saline and boiled for 5 minutes and filtered. When this extract is layered over the anti-anthrax serum in a narrow tube, a ring of precipitate appears at the junction of two liquids within 5 minutes in a positive case.

## Treatment

*B. anthracis* is generally sensitive to penicillins; therefore, penicillin G is the first-line treatment. Penicillin, such as amoxicillin or amoxicillin/clavulanic acid, is effective for the treatment of cutaneous anthrax. But after October 2001, ciprofloxacin or doxycycline is usually recommended due to the possibility of genetically engineered penicillin-resistant anthrax strains. Patients with inhalational anthrax are treated with multidrug regimen of either ciprofloxacin or doxycycline along with at least one more antibiotic, such as vancomycin, imipenem, meropenem, chloramphenicol, rifampin, tetracycline, clindamycin, and aminoglycosides. Ciprofloxacin or doxycycline for 60 days is effective against cases of GI anthrax. Doxycycline is not suitable for use in suspected cases of anthrax meningitis, because it has poor penetration of the central nervous system. *B. anthracis* shows resistance to sulfonamides and extended-spectrum cephalosporin.

Antimicrobial therapy makes lesions culture-negative within hours, but the clinical manifestations of anthrax are related to the effects of the anthrax toxins. Antibiotics are ineffective once the toxin is formed; however, they may reduce the case fatality rate.

## Prevention and Control

These include (a) chemoprophylaxis with antibiotics, (b) immunoprophylaxis with vaccination, and (c) decontamination of animal products.

### ► Chemoprophylaxis

Chemoprophylaxis is indicated for people who have been exposed to anthrax but do not have symptoms of the disease. This is useful to reduce the risk or progression of disease due to inhaled anthrax spores. Ciprofloxacin, tetracyclines including doxycycline, or penicillin administered for a period of 60 days is effective.

### ► Immunoprophylaxis

Immunoprophylaxis includes vaccination in animals and in humans.

**Vaccination in animals:** Control of anthrax in animals is essential to prevent transmission of infection to humans. Vaccines comprising killed bacilli and/or capsular antigens produce no significant immunity. A nonencapsulated toxigenic strain has been used effectively for vaccination in livestock.

The *Sterne vaccine* contains spores of a nonencapsulated avirulent mutant strain of *B. anthracis*. The mutant strain produces sublethal amounts of the toxin that induces formation of protective antibodies. The animal is protected for a year with a single injection of spore vaccine. It is extensively used in animals; however, it is not safe for human use. The vaccination of animals has also been used:

- to protect people living in an area endemic for the disease and
- to protect persons dealing with animal and animal products.

## Vaccines

**Vaccination in humans:** A noncellular human anthrax vaccine called anthrax vaccine adsorbed (AVA) is available for individuals in high-risk occupations only in the United States.

The vaccine is a preparation of the PA recovered from the culture filtrate of an avirulent, nonencapsulated strain of *B. anthracis* that produces PA during active growth.

- Anthrax immunization consists of three subcutaneous injections given 2 weeks apart followed by three additional subcutaneous injections given at 6, 12, and 18 months. Annual booster injections of the vaccine are required to maintain a protective level of immunity.
- The vaccine is recommended for the use as part of post-exposure treatment of healthy individuals from 18 to 65 years of age, who are at a risk of exposure to anthrax.

### ► Decontamination of animal products

These include proper sterilization of animal products, such as wool, hides, etc., and improvement of personal hygiene.

## Anthracoid Bacilli

*Bacillus* species resembling *B. anthracis* are collectively called as anthracoid or pseudoanthrax bacilli. These are the opportunistic pathogens with low virulence. They are ubiquitous organisms, present virtually in all environments. Some of them are frequent laboratory contaminants.

- *B. cereus* is the most important pathogen causing GI infection, ocular infections, and catheter-related infections.
- *Bacillus subtilis* may act as an opportunistic pathogen, causing eye infections and septicemia.
- *Bacillus licheniformis* has also been incriminated in patients with food poisoning.

Spores of *Bacillus stearothermophilus* are used to test the efficiency of sterilization by autoclaves. Some species of *Bacillus* are used for the production of antibiotics, such as bacitracin, tyrothricin, and polymyxin.

## *Bacillus cereus*

*B. cereus* is the most important pathogen known to cause food poisoning. *B. cereus* is a normal inhabitant of the soil, but it can be regularly isolated from foods, such as grains and spices. Episodes of *B. cereus* food poisoning occur sporadically worldwide. This occurs due to the ingestion of contaminated food in which bacteria have multiplied to high levels under conditions of improper storage after cooking.

*B. cereus* is widely distributed in nature, such as soil, vegetables, milk, cereals, spices, meat, and poultry.

*B. cereus* is a spore-forming Gram-positive bacillus. It is generally motile, but nonmotile strains may also occur. It is a facultative anaerobe. It is a nonfastidious bacterium that grows on ordinary media, such as nutrient agar. Mannitol, egg yolk,

phenol red polymyxin agar (MYP) is the selective media used for the isolation of *B. cereus* from feces and other sources. *B. cereus* ferments glucose, but not mannitol, and produces the enzyme lecithinase. *B. cereus* spores can survive in the soil over a long period. It resembles *B. anthracis* but differs from it by certain features as mentioned in Table 28-3. *B. cereus* produces many toxins and enzymes, which are responsible for many syndromes:

- The heat-labile enterotoxin is similar to the enterotoxins produced by *Vibrio cholerae* and *Escherichia coli*. The toxin stimulates adenyl cyclase-cAMP system causing profuse watery diarrhea. Like other enterotoxin, it causes accumulation of fluid in ligated rabbit ileal loop. The toxin causes diarrheal form of *B. cereus* food poisoning.
- The heat-stable enterotoxin causes emetic form of *B. cereus* food poisoning, but the exact mechanism of action of the toxin is not known.

*B. cereus* also produces at least three other toxins (a) cerolysin, a potent haemolysin; (b) necrotic toxin, a heat-labile toxin; and (c) phospholipase C, a potent lecithinase. They have been implicated to cause ocular infections such as *Bacillus* panophthalmitis.

Diarrheal form of *B. cereus* food poisoning, caused by heat-labile enterotoxin, results from the consumption of

contaminated vegetables, meat, or sauces. The incubation period is long (8–12 hours) during which the organisms multiply and produce heat-labile toxins. The symptoms consist of acute abdominal pain, diarrhea, and nausea; vomiting is rare. The disease generally lasts for 24 hours or more. The fecal samples contain small numbers of *B. cereus*. Diarrheal form of food poisoning is caused by *B. cereus* serotypes 2, 6, 8, 9, 10, or 12.

Emetic form of *B. cereus* food poisoning, caused by heat-stable enterotoxin, results from the consumption of contaminated rice. During the initial cooking of rice, most bacilli are killed but heat-resistant spores survive. If the food is kept at room temperature, the spores germinate to vegetative forms, which multiply and produce enterotoxins. Heat-resistant enterotoxins are not killed on reheating the rice. On ingestion of the rice, the toxin causes nausea, vomiting, and abdominal cramps after a short incubation period of 6 hours. Diarrhea and fever are rare. *B. cereus* is present in large numbers in the cooked rice as well as in the fecal samples of these patients. The disease usually lasts for a shorter duration of 24 hours or less. Emetic form of food poisoning is caused by *B. cereus* serotypes 1, 3, or 5.

*Bacillus* panophthalmitis results following any traumatic and penetrating injury of the eye with a soil-contaminated object. It is a serious, rapidly progressive infection of the eye resulting in loss of the vision within 48 hours of the injury.

Intravenous catheter septicemia and endocarditis are the other infections caused by *B. cereus* in immunocompromised patients.

Suspected food, feces, and vomitus are cultured on ordinary media or a special MYP medium. Spore-bearing Gram-positive bacilli may be seen on smear from the colonies. Specimens from infected eye and intravenous catheter sites and other specimens may be cultured for isolation of the bacteria.

Food poisoning is mild and self-limiting, requiring no specific treatment. Other *Bacillus* infections need prompt treatment with antibiotics. *B. cereus*—causing other infections—shows a high incidence of multiple drug resistance. It is resistant to penicillins and cephalosporins. It is sensitive to gentamicin, ciprofloxacin, clindamycin, and vancomycin.

Food poisoning is prevented by adequate cooking, avoidance of recontamination of cooked food, and proper storage (efficient refrigeration).

TABLE 28-3

### Differentiating features between *Bacillus anthracis* and *Bacillus cereus*

Characteristics	<i>Bacillus anthracis</i>	<i>Bacillus cereus</i>
Motility	Nonmotile	Motile
Capsule	Capsulated	Noncapsulated
Medusa head colony	Present	Absent
Hemolysis on sheep blood agar	Absent	Present
Growth on chloral hydrate agar	Absent	Present
Gelatin liquefaction	Slow	Rapid
String-of-pearls test	Positive	Negative
Lysis by gamma phage	Positive	Negative
Mouse pathogenicity	Positive	Variable

### CASE STUDY

A group of 35 people in a village joined in a community dinner. They consumed a mutton preparation, among other dishes. Two days after dinner, 20 of them fell sick with severe abdominal pain and fever, followed by nausea, vomiting, and diarrhea. Some patients had blood diarrhea. All were admitted to a local hospital. History revealed that the meat of a sheep, which died in the morning, was cooked for the dinner. Few other sheep were also found to be dead. Veterinary doctors examined the carcasses of the sheep and diagnosed anthrax to be the cause of death of these animals. The patients suspected to be suffering from GI anthrax were treated with a course of ciprofloxacin. All the patients recovered fully.

- What was the infective stage of the bacteria that caused the disease?
- What investigations would be useful to diagnose the condition?
- What are the modes of transmission of anthrax?
- What are the vaccines available against anthrax in animals and humans?
- Do these bacteria show any resistance to antibiotics?

# Clostridium

## Introduction

The genus *Clostridium* consists of Gram-positive, anaerobic bacilli capable of forming endospores. The endospores typically are wider than the bodies of the bacilli, giving the bacteria a swollen appearance resembling a spindle, hence the name *Clostridium* (*kloster*, spindle).

## Clostridium

Many methods have been followed for classification of clostridia. The traditional method for the classification of *Clostridium* is based on a combination of different characteristics, which include:

1. Optimal growth in anaerobic conditions.
2. Demonstration of spores.
3. Biochemical tests.
4. Gas chromatographic analysis of metabolic products of the bacteria.

As per this classification, more than 130 species have been described in the genus *Clostridium*. Most species are found as harmless saprophytes in the soil, water, sewage, and decomposed (animal and plant) products. They are also present as part of the normal flora in the gastrointestinal tract of humans and animals. Only few species cause infections in humans (Table 29-1).

Clostridia are more commonly associated with skin and soft tissue infections, antibiotic-associated diarrhea, and food poisoning. Tetanus, gas gangrene, and botulism are three major clinical syndromes caused by *Clostridium* species. Pathogenicity of clostridia is attributed to the following features:

1. They produce a number of neurotoxins, enterotoxins, and histolytic toxins.
2. They survive as spores in adverse environmental conditions.
3. They grow well in enriched media in anaerobic conditions.

## General Properties of Clostridia

Clostridia show following morphological properties:

- Most species are anaerobic but few species such as *Clostridium tertium*, *Clostridium histolyticum*, etc. are aerotolerant and hence can grow on agar even in presence of air.
- Clostridia are rod-shaped bacilli measuring  $3-8 \times 0.4-1.2 \mu\text{m}$  in size.
- The bacilli are highly pleomorphic and show long filaments and involution forms.
- They are Gram-positive but old cultures may appear Gram-variable and even Gram-negative.
- Most *Clostridium* species with few exceptions (e.g., *Clostridium perfringens*, *Clostridium tetani* type VI) are motile due to the presence of peritrichous flagella.

TABLE 29-1

### Human infections caused by *Clostridium* species

Bacteria	Diseases
<i>Clostridium perfringens</i>	Soft tissue infections (cellulitis, fasciitis, suppurative myositis, clostridial myonecrosis, and gas gangrene), food poisoning, necrotizing enteritis, and septicemia
<i>Clostridium novyi</i>	Gas gangrene (rare)
<i>Clostridium sordelli</i>	Gas gangrene (rare)
<i>Clostridium septicum</i>	Gas gangrene
<i>Clostridium tetani</i>	Tetanus (generalized tetanus, localized tetanus, cephalic tetanus, and neonatal tetanus)
<i>Clostridium botulinum</i>	Botulism
<i>Clostridium barati</i>	Botulism (rare)
<i>Clostridium butyricum</i>	Botulism (rare)
<i>Clostridium histolyticum</i>	Botulism (rare)
<i>Clostridium difficile</i>	Antibiotics-associated diarrhea
<i>Clostridium tertium</i>	Opportunistic infections

- Most clostridia except *C. perfringens* and *Clostridium butyricum* are noncapsulated.
- Ability to produce endospores is the most important feature of clostridia.

**Spores:** Formation of spores is variable depending on the species. *Clostridium sporogenes* and other clostridia sporulate readily, while *C. perfringens* and other species produce spores inconsistently. Sporulation takes place outside in the environment and also in animal bodies, but not in humans. The shape and location of the spores (Fig. 29-1) in the bacteria vary in different clostridial species:

1. **Central spores:** In *Clostridium bifermentans*, giving the bacillus a spindle shape.
2. **Subterminal spores:** In *C. perfringens*, giving the bacillus a club shape.
3. **Oval terminal spores:** In *C. tertium*, giving the bacillus a tennis racket shape.
4. **Spherical terminal spores:** In *C. tetani*, giving the bacillus a drumstick appearance.

Spores are relatively more resistant forms than the vegetative forms of the bacilli. They show a variable degree of resistance to heat, drying, and disinfectants. Spores are killed by 1% aqueous solution of iodine and 2% glutaraldehyde at pH 7.5–8.5. They are particularly resistant to phenolic disinfectants. The spores survive in 2% formaldehyde solution even for up to 5 days. *Clostridium botulinum* spores survive boiling at 105°C for 3–4 hours, while spores of *C. perfringens* and *C. tetani* are rapidly destroyed by boiling for less than 5 minutes. Some strains of *C. tetani* can resist boiling for 15–90 minutes. *C. perfringens* type A strains, however, survive boiling for several hours.

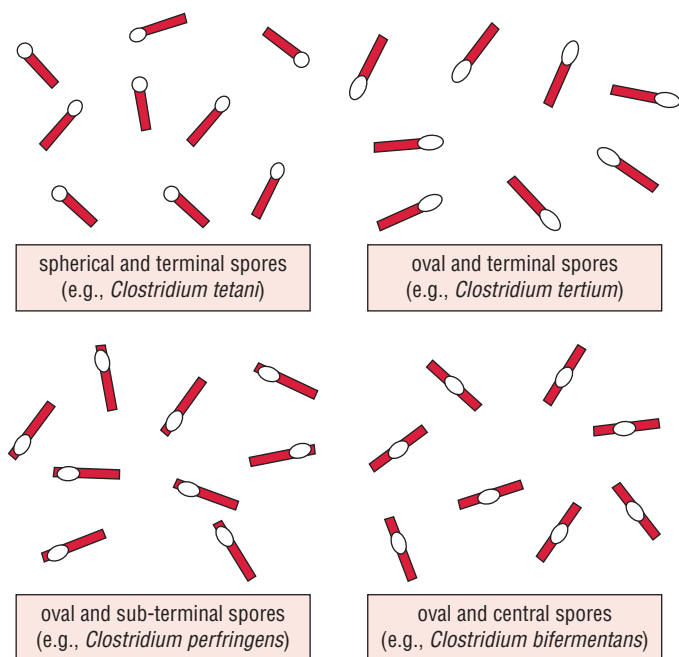

**FIG. 29-1.** Schematic diagram showing different types and arrangement of spores.

**Culture:** Most species are anaerobic but few species, such as *C. tertium*, *C. histolyticum*, etc., are aerotolerant and hence can grow on agar even in presence of air. Presence of adequate quantity of low redox potential (Eh) substances in the media is important for the growth of these anaerobic bacteria. Use of reducing substances, such as ascorbic acid, glutathione, unsaturated fatty acids, cysteine, thioglycolic acid, alkaline glucose, or metallic iron maintain low redox potentials in the medium.

Most clostridia grow at an optimum temperature of 37°C and pH of 7–7.4. Growth on solid media is variable. Some clostridial species produce hemolysis on blood agar. Robertson's cooked meat (RCM) broth is a useful medium for the growth of clostridia. The medium contains unsaturated fatty acids, digested meat, and sulfhydryl compounds. Clostridia grow well in the medium, rendering the broth turbid. Saccharolytic clostridia turn the meat pink, while proteolytic species turn the meat black and produce foul smell. Most clostridia produce gas.

**Sensitivity to antibiotics:** The bacteria are sensitive to metronidazole, penicillin, and cephalosporins. They are less sensitive to tetracyclines and resistant to quinolones and aminoglycosides.

## *Clostridium perfringens*

*C. perfringens* is the most important *Clostridium* species causing gas gangrene, a severe life-threatening disease. The bacteria also cause necrotic enteritis and food poisoning.

## Properties of the Bacteria

### ► Morphology

*C. perfringens* shows following morphological features:

- *C. perfringens* is a large, rectangular, Gram-positive bacillus measuring 4–6 μm in length; it is a straight bacillus with parallel sides and round and truncated ends.
- The bacilli occur as single, in chains, or in bundles. The bacilli are capsulated.
- The bacilli are nonmotile, however, the bacteria multiply rapidly, giving a characteristic spreading colony appearance on the media, resembling the growth of motile clostridia.
- They possess central or subterminal spores. The spores, however, are rarely seen either in clinical specimens from lesions or in culture media.

### ► Culture

*C. perfringens* is an anaerobic but aerotolerant bacterium. The bacteria can grow under microaerophilic conditions and do not die on exposure to air. They grow at a temperature range of 20–44°C (optimum temperature 37°C) and a pH range of 5.5–8.0.

**1. Robertson's cooked meat (RCM) broth:** *C. perfringens* grows rapidly in tissues and in culture media. In RCM medium, *C. perfringens* produces good growth. The meat is not digested



but is turned pink. It produces an acidic reaction and a sour odor in the culture. Some strains of *C. perfringens* can grow optimally at 45°C with a generation time reduced to 10 minutes. This property is made use of in the isolation of *C. perfringens* in RCM medium (Fig. 29-2), when specimens are contaminated with other clostridial species. Inoculation of the specimens in RCM media followed by incubation at 45°C for 4–6 minutes and subsequently culturing on blood agar produces pure and predominant colonies of *C. perfringens*.

**2. Blood agar:** On blood agar containing human, sheep, or rabbit blood, *C. perfringens* on prolonged incubation produces dual zone of hemolysis (Fig. 29-3, Color Photo 27). This is due to a narrow zone of complete hemolysis by theta-toxin and a much wider zone of incomplete hemolysis by the alpha-toxin of the bacteria.

### ► Biochemical reactions

*C. perfringens* shows following reactions:

- *C. perfringens* is metabolically active. The bacteria ferment glucose, lactose, sucrose, and maltose with the production of acid and gas.



FIG. 29-2. Robertson's cooked meat (RCM) medium.

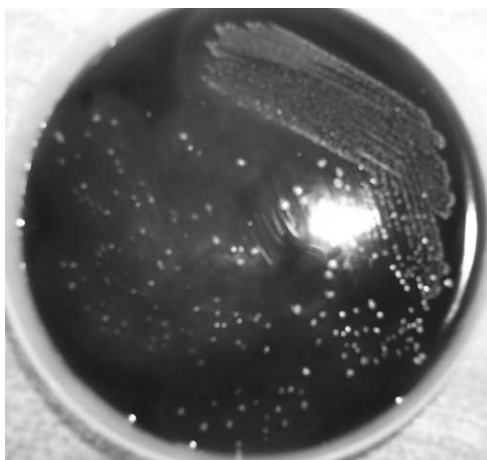

FIG. 29-3. Target hemolysis caused by *Clostridium perfringens* on blood agar.

- They produce H<sub>2</sub>S and reduce nitrate to nitrite.
- They are MR positive, VP negative, and indole negative.
- They ferment lactose with the production of acid in litmus milk. The color of the medium changes from blue to red. Casein of the milk is coagulated by the production of acid and the coagulated milk is broken down by the production of large volume of gas. Due to the release of gas, the paraffin plug is pushed up with shreds of broken clot adhering to the sides of the glass tube. This reaction is known as **stormy fermentation**, characteristic of *C. perfringens*.

### ► Other properties

**Susceptibility to physical and chemical agents:** *C. perfringens* spores are killed within 5 minutes by boiling, but spores of certain strains (food poisoning strain of type A, certain strains of type C) are killed by boiling for a longer period of 1–3 hours. The spores are also killed by autoclaving at 121°C for 15 minutes. *C. perfringens* spores are resistant to commonly used antiseptics and disinfectants. The bacilli are sensitive to metronidazole and penicillins.

**Typing:** On the basis of four major toxins (alpha-, beta-, epsilon-, and iota-toxin) produced by *C. perfringens*, strains of *C. perfringens* are classified into five types (A, B, C, D, and E). Typing of strains is carried out by *in vivo* test in animals. This is carried out by neutralization of the toxins with specific antitoxins via intravenous or percutaneous injections in mice.

## Pathogenesis and Immunity

### ► Virulence factors

*C. perfringens* produces more than 12 toxins and enzymes. All these are the virulence factors, which contribute to pathogenesis of the diseases (Table 29-2).

### Toxins

**Major toxins:** Alpha-, beta-, epsilon-, and iota-toxin are the four major toxins produced by *C. perfringens*.

**Alpha-toxin:** It is the most important toxin produced by all strains of *C. perfringens*. The largest volumes of alpha-toxin are provided by *C. perfringens* type A strain.

- The alpha-toxin is a lecithinase, a phospholipase C, which in the presence of calcium and magnesium ions breaks down lecithin into phosphoryl choline and diglyceride.
- The toxin is responsible for toxemia typically observed during gas gangrene.
- It is lethal, dermonecrotic, and hemolytic. The alpha-toxin increases vascular permeability of blood vessels, thereby causing massive hemolysis and bleeding, tissue destruction, and myocardial dysfunction. The toxin lyses erythrocytes, leukocytes, platelets, and endothelial cells. The alpha-toxin causes hemolysis of red cells of most of the animal species except for goat and horse. The toxin is relatively heat stable and is partially inactivated by boiling for 5 minutes. The lysis of red cells is observed best on incubation at 37°C followed by reincubation at 4°C (*hot-cold lysis*).

TABLE 29-2

Virulence factors of *Clostridium perfringens*

Virulence factors	Biological functions
$\alpha$ (Alpha) toxin	Lethal, dermonecrotic, hemolytic, and is a lecithinase; causes toxemia, increases vascular permeability of blood vessels, leading to tissue destruction. Main cause of toxemia associated with gas gangrene
$\beta$ (Beta) toxin	Lethal toxin; causes necrotic lesions in necrotizing enteritis
$\epsilon$ (Epsilon) toxin	Lethal protoxin; increases vascular permeability of the wall of the gastrointestinal tract
$\iota$ (Iota) toxin	Lethal toxin; causes necrotic lesions and increases vascular permeability
$\delta$ (Delta) toxin	Hemolytic
$\theta$ (Theta) toxin	Oxygen-labile hemolytic and cytolytic toxin
$\kappa$ (Kappa) toxin	Collagenase
$\lambda$ (Lambda) toxin	Proteinase and gelatinase
$\mu$ (Mu) toxin	Hyaluronidase
$\nu$ (Nu) toxin	Deoxyribonuclease
Enterotoxin	Enterotoxic and hemolytic; alters permeability of the gastrointestinal membrane
Neuraminidase	Alters cell surface ganglioside receptors and promotes capillary permeability
Bursting factor	Causes typical muscle lesions in gas gangrene
Circulating factor	Increases adrenaline sensitivity of the capillary membrane
Hyaluronidase	Breaks down intercellular cement substance and promotes the spread of infection along tissue planes

**Other major toxins:** Beta-, epsilon-, and iota-toxin are the other major toxins in addition to the alpha-toxin; these toxins also play a major role in pathogenesis of the disease.

- The beta-toxin causes necrotic lesions in necrotizing enteritis.
- The epsilon-toxin is a protoxin, which is activated by trypsin. This toxin increases vascular permeability of the wall of gastrointestinal tract.
- The iota-toxin is a lethal toxin, which produces necrotic lesions and increases vascular permeability.

**Minor toxins:** These include delta, theta, kappa, lambda, mu, and nu toxins:

- Delta-toxin is lethal and is hemolytic to the sheep, goat, cattle, etc. red cells.
- Theta-toxin is an oxygen-labile hemolysin and is a cytolytic toxin.
- Kappa-toxin is a collagenase.
- Lambda-toxin is a proteinase and gelatinase.
- Mu-toxin is a hyaluronidase.
- Nu-toxin is a deoxyribonuclease.

**Enterotoxin:** Enterotoxin is produced primarily by type A strain of *C. perfringens*. This is a heat-labile protein. The toxin is produced during the stage of sporulation of vegetative cells to form spores, which is stimulated by alkaline environment of the small intestine. The toxin binds specifically to receptors in the epithelium of the small intestine. This causes disruption in transport of ions in the ileum and jejunum and alters permeability of the membrane. The toxin is antigenic, but the specific antibodies against this toxin found in the serum are not protective.

### Enzymes and biologically active soluble substances

*C. perfringens* produces many enzymes and many biologically active soluble substances.

- Neuraminidase is the most important enzyme, which alters cell surface ganglioside receptors and promotes capillary permeability.
- Other soluble substances produced by *C. perfringens* include fibrinolysin, histamine, a “bursting factor”, and a “circulating factor”.
  - The “bursting factor” acts specifically on muscle tissue and may be responsible for typical muscle lesions observed in gas gangrene.
  - The “circulating factor” increases adrenaline sensitivity of the capillary membrane and also inhibits phagocytosis.

### Pathogenesis of gas gangrene

Mere presence of *Clostridium* species in wound does not cause gas gangrene. The course of infection after contamination of wound depends on (a) multiplication of the clostridia and (b) subsequent invasion of the tissue. Infection may progress through the following stages:

- 1. Simple wound contamination:** The condition is associated with no invasion of the underlying tissues or no production of toxins. Hence, there is only delayed healing of the lesion.
- 2. Cellulitis:** In this condition, clostridia invade the fascial planes and cause anaerobic cellulitis, with gas formation in the soft tissues. The bacteria produce minimal toxin and do not invade the muscle tissues.
- 3. Gas gangrene or clostridial myonecrosis:** Gas gangrene is a rapidly spreading edematous myonecrotic life-threatening

condition caused by *C. perfringens*. The condition occurs in association with extensive muscle trauma contaminated with *C. perfringens* or other pathogenic clostridia. Gas gangrene is rarely caused by a single *Clostridium* species, it is usually caused by multiple *Clostridium* species (Table 29-1). The condition is commonly associated with anaerobic streptococci and facultative anaerobes, such as staphylococci, *Escherichia coli*, and *Proteus* species. *C. perfringens* (predominantly type A) is the most common species causing gas gangrene. Gas gangrene is caused by an inoculation of *C. perfringens* type A into tissues during trauma or surgery followed by replication of the bacteria and subsequent invasion of the tissues. Factors that contribute to the multiplication of *C. perfringens* and other anaerobic bacteria at the site of the wound are:

- Low oxygen tension is the most important condition, which is most frequently seen in war wounds with implanted bullets or shell fragments, along with soil particles and bits of clothing.
- Tearing of arteries and crushing of tissue cause anoxia of the muscles.

Extravasation of the blood reduces blood supply to the affected part still further, thereby causing more tissue anoxia. This contributes to a fall in the oxygen tension and pH of the damaged tissues.

Breakdown of carbohydrates and liberation of amino acids from the proteins inside the damaged and anoxic muscles also provides a suitable condition for the multiplication of anaerobic bacteria. Clostridia multiply in large numbers and then produce abundant toxins, which cause further tissue damage.

### Key Points

A large number of toxins and enzymes produced by *C. perfringens* contribute further to tissue damage:

- The enzyme lecithinase causes increased permeability of capillaries, leading to extravasation and increased tension in the damaged muscle tissue, causing further anoxia.
- Abundant production of gas by the bacteria further reduces the blood supply and causes anoxia.
- The alpha-toxin lyses erythrocytes and causes hemolytic anemia and hemoglobinuria, observed in the condition.
- The collagenase destroys tissue matrix and hyaluronidase destroys intercellular substances, thereby facilitating further invasion and spread of the bacteria in tissues.

### Clinical Syndromes

*C. perfringens* produces a variety of clinical syndromes as follows: (a) soft tissue infections, (b) food poisoning, (c) necrotizing enteritis, and (d) septicemia.

#### ► Soft tissue infections

Soft tissue infections caused by *C. perfringens* can be (a) cellulitis, (b) fasciitis and suppurative myositis, and (c) clostridial myonecrosis or gas gangrene.

**Cellulitis:** Clostridia can invade the fascial planes and cause anaerobic cellulitis with gas formation in the soft tissues. The bacteria produce minimal toxin and do not invade the muscle tissues.

**Fasciitis and suppurative myositis:** The cellulitis progresses to suppurative myositis, which is associated with collection of pus in the muscle planes. In this condition, both muscle necrosis and systemic symptoms are absent.

**Gas gangrene:** Gas gangrene or clostridial myonecrosis is a serious and life-threatening condition. The incubation period is variable. It may be as short as 7 days or as long as 6 weeks after clostridia are introduced into the tissue by trauma or surgery. The onset of the disease is rapid and is associated with increasing pain, tenderness, and edema of the affected part and systemic signs of toxemia. Accumulation of gas in the tissues—caused by metabolic activity of the rapidly dividing clostridia—is characteristic of the disease, hence the name gas gangrene. Production and accumulation of gas make the tissues crepitant. There is a thin watery discharge from the wound, and subsequently the discharge becomes serosanguineous. In untreated cases, the condition progresses very fast with extensive muscle necrosis, shock, renal failure, and even death within 48 hours of onset of the disease. The clostridial toxins typically cause extensive hemolysis and bleeding, and finally death occurs due to circulatory failure.

#### ► Food poisoning

Clostridial food poisoning is caused by some strains of *C. perfringens* type A. These strains produce spores, which are heat resistant. They typically produce enterotoxin, but production of alpha- and theta-toxin is very minimal.

Food poisoning is caused by ingestion of cold and warmed up meat dishes contaminated with large numbers ( $10^8$ – $10^9$ ) of *C. perfringens* type A strains. Incubation period is short, between 8 and 24 hours. Abdominal cramps and watery diarrhea—but absence of nausea, vomiting, or fever—are characteristic presentations of this condition. The disease is self-limiting and recovery occurs within 24–48 hours.

#### ► Necrotizing enteritis

Necrotizing enteritis caused by *C. perfringens* type C is an acute necrotizing condition of the jejunum. The condition is characterized by abdominal pain, bloody diarrhea, shock, and peritonitis. It is severe and often fatal. Immunization with type C toxoid has been reported to protect against this condition. This condition is known as “Pigbel” in Papua New Guinea, where it is very common and as “Darmbrand” (meaning “fire bowels”) in Germany. The sporadic cases have also been reported from East Africa, Thailand, and Nepal.

#### ► Septicemia

This is a life-threatening situation with the isolation of bacteria in blood culture.

## Epidemiology

### ► Geographical distribution

*C. perfringens* is distributed world wide. *C. perfringens* type A is responsible for most human diseases including food poisoning, soft tissue infections, gas gangrene, and primary septicemia. *C. perfringens* type C is responsible for enteritis necroticans.

### ► Habitat

*C. perfringens* type A is part of the normal flora of the intestinal tract of humans and animals. These bacteria are excreted in the feces and hence contaminate the skin of the perianal region, buttocks, and thighs. *C. perfringens* type A spores are ubiquitous. They are found in the soil, dust, and air. They remain viable for a very long period even in adverse environmental conditions. *C. perfringens* types B, C, D, and F colonize the intestinal tracts of animals and occasionally humans. Their spores usually do not survive in soil.

### ► Reservoir, source, and transmission of infection

Gas gangrene occurs following road traffic accidents or any other injuries (like during war) involving crushing trauma of large muscle mass contaminated with pathogenic clostridia. Rarely, the condition may occur following surgical operations. The condition is caused by:

- Contamination of wound with soil, such as manure soil or cultivated soil, road dusts, or bits of clothing heavily contaminated with *C. perfringens* and other pathogenic clostridia (*exogenous infection*).
- *Clostridium* species that are present on the normal skin, especially on the perineum and thighs, which invade through a wound and cause the infection (*endogenous infection*).

Clostridial food poisoning occurs following ingestion of cold or warmed up meat dishes contaminated with spores of *C. perfringens* type A. Spores are responsible for the infection.

Foods contaminated with large number of bacteria are the sources of exogenous infection in case of necrotizing enteritis. The conditions that facilitate exposure of the food to a large number of *C. perfringens* spores and malnutrition are the risk factors for the disease.

## Laboratory Diagnosis

Laboratory diagnosis of gas gangrene and other soft tissue diseases is carried out to:

- (a) Confirm the diagnosis,
- (b) Identify the clostridial species, and
- (c) Differentiate gas gangrene from anaerobic streptococcal myositis.

Treatment has to be started immediately in suspected as well as clinically diagnosed cases without waiting for the laboratory results.

### ► Specimens

The specimens for gas gangrene include the following:

1. Pus and other exudates from deeper part of the wound and from the sides where infection appears to be most acute; the specimen is collected by a capillary tube and swab.
2. Smears from the muscles at the edge of the affected site, from the pus and/or exudate from deeper parts of the wound, and from the necrotic tissue.
3. Necrotic tissue and pieces of muscle fragments.

The specimens for investigation of food poisoning include feces and remnants of food.

### ► Microscopy

Gram staining of smears is a useful method in diagnosis of *C. perfringens* infection. It provides information regarding the species of clostridia that causes the infection and also indicates relative number of the clostridial species found in clinical specimens:

1. Demonstration of a large number of Gram-positive bacilli without spores, and absence of leukocytes in stained smears of clinical specimens, is suggestive of *C. perfringens* infection.
2. Large-sized Gram-positive bacilli with the presence of oval and subterminal spores suggest *Clostridium novyi*.
3. Leaf-shaped or boat-shaped pleomorphic bacilli with irregular staining suggest *Clostridium septicum*.
4. Slender bacilli with oval and terminal spores suggest *C. tetani* or *Clostridium tetanomorphum*.

### ► Culture

Specimens are inoculated simultaneously on a set of two fresh and heated blood agar containing 5–6% agar to prevent swarming. One inoculated medium is incubated aerobically and the another inoculated medium is incubated anaerobically for 24 hours or less. *C. perfringens* grows very rapidly, hence colonies can be demonstrated on the media after a few hours of incubation.

A set of four tubes of RCM media are inoculated and heated at 100°C for 5, 10, 15, and 20 minutes and incubated at 37°C for 24–48 hours. Subsequently, subcultures are made on blood agar to detect and differentiate various clostridial species.

In cases of septicemia, blood culture is often positive for *C. perfringens* and *C. septicum*.

### ► Identification of bacteria

The identifying features of *C. perfringens* colonies are presented in Box 29-1.

**Nagler reaction:** Nagler reaction is a useful test for rapid detection of *C. perfringens* in clinical specimens (Fig. 29-4, Color Photo 28). This reaction demonstrates biological property of the enzyme lecithinase—to produce opalescence in the serum and in the egg yolk media. This reaction is specifically neutralized by the use of specific antitoxin.

### Box 29-1 Identifying features of *Clostridium perfringens*

1. Grows rapidly and produces spreading colonies on solid media.
2. Produces a double zone of hemolysis around colonies on blood agar.
3. Large rectangular Gram-positive bacilli in the Gram-stained smear of the colony.
4. Nonmotile and capsulated bacteria.
5. Ferments lactose with production of acid in litmus milk (stormy fermentation positive).
6. Nagler reaction positive.

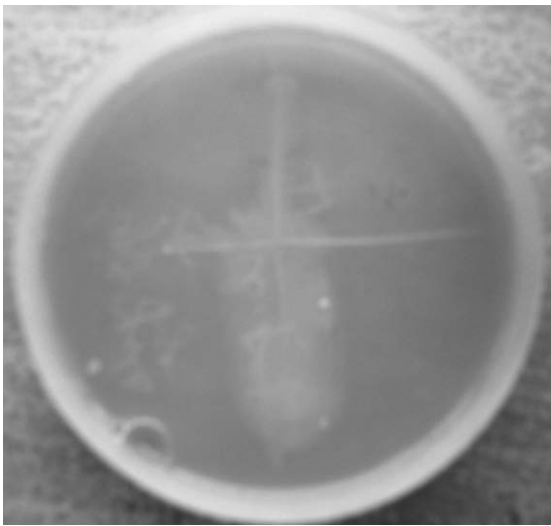

FIG. 29-4. Nagler reaction.

The test is performed by culturing *C. perfringens* on a medium containing 6% agar, 5% Fildes peptic digest of sheep blood, and 20% human serum and antibiotic neomycin sulfate. One-half of the medium is inoculated with specific antitoxin raised against *C. perfringens*, while the other half of the medium does not contain any antitoxin. After 48 hours of incubation, the colonies of *C. perfringens* on part of the agar without antitoxin do not show any opacity. This is due to the neutralization of enzymatic activity of the enzyme lecithinase. The aerobic spore bearers and coliforms are inhibited by neomycin sulfate in the medium, which makes the medium more selective for *C. perfringens*.

*C. novyi*, *C. bifermentans*, some aerobic spore bearers, and some *Vibrio* species produce the enzyme lecithinase; therefore, they also produce opalescence in the egg yolk medium. However, reaction is not neutralized by *C. perfringens* antitoxin, but rather by the antitoxin of *C. bifermentans*, which produces a serologically related lecithinase.

Laboratory diagnosis of food poisoning is made by demonstration of more than  $10^6$  bacteria per gram of feces, collected within 24 hours of the onset of the condition.

### ► Serodiagnosis

An enzyme immunoassay to detect enterotoxin in feces has recently been developed for diagnosis of food poisoning.

### Treatment

Surgery is the mainstay of prophylaxis and treatment of gas gangrene. The cases are treated aggressively with prompt removal of damaged tissue and clearing the wounds to remove foreign materials, necrotic tissue, and blood clots. Hyperbaric oxygen treatment has been suggested to be beneficial. Antiserum against alpha-toxin is no longer used.

Metronidazole is the antibiotic of choice. Prophylactic use of the antibiotic in association with surgery is effective. The drug is administered intravenously before surgery and is given three times a day at an interval of 8 hours.

Antibiotic prophylaxis using broad-spectrum antibiotics, such as gentamicin, amoxicillin, and metronidazole, is effective, since occurrence of mixed infections with aerobic and anaerobic bacteria is frequent.

Antibiotic therapy is not recommended for the treatment of *C. perfringens* food poisoning.

### Prevention and Control

Use of antibiotics and wound hygiene are the key factors that help in prevention of *C. perfringens* infections. Wounds are cleansed and debrided, and penicillin may be given for prophylaxis. No vaccine is available against these diseases.

### *Clostridium tetani*

*C. tetani*, an obligate anaerobic Gram-positive bacillus, causes tetanus. Tetanus is an infectious disorder characterized by an increased muscle tone and spasms caused by the release of a neurotoxin, **tetanospasmin**, produced by *C. tetani* when it gets inoculated into humans.

### Properties of the Bacteria

#### ► Morphology

*C. tetani* shows following features:

- *C. tetani* is a slender, Gram-positive bacillus measuring 4–8  $\mu\text{m}$  in length. Young cultures are usually Gram-positive but old cultures are Gram-variable and even Gram-negative.
- It is a straight bacillus with parallel sides and rounded ends. The bacillus occurs in singles and occasionally in chains. The bacteria consist of round, terminal, and bulging spores giving drumstick appearance to the bacillus. The spores are rarely seen even in clinical specimens from lesions or in culture media.
- All strains of *C. tetani* except type VI are motile by the presence of flagella. Type VI strain bacilli do not contain any flagella, hence are non-motile.
- The bacterium is capsulated.

## ► Culture

*C. tetani* is an obligate anaerobe. The bacteria are extremely sensitive to oxygen, hence can grow only in the absence of oxygen. The bacillus grows at an optimum temperature of 37°C and at pH of 7.4. *C. tetani* can grow on ordinary media and on media enriched with serum and blood.

**1. RCM medium:** *C. tetani* grows well on RCM medium (Fig. 29-2). The bacteria produce turbidity with production of some gas in the medium. The meat, although is not digested, turns black on prolonged incubation.

**2. Blood agar:** On blood agar, *C. tetani* produces alpha-hemolysis surrounding the colonies. On prolonged incubation, the alpha-hemolysis becomes beta-hemolytic due to production of tetanolysin, a hemolysin produced by the bacteria. Surface colonies tend to swarm over the entire surface of the agar. *C. tetani* produces an extremely fine translucent film of growth, which is difficult to visualize except at the edges of the colonies (Color Photo 29).

**3. Gelatin stab culture:** *C. tetani* liquefies gelatin anaerobically. Hence, the bacillus produces a *fir-tree type* of growth in gelatin stab culture under anaerobic incubation.

**4. Nutrient agar slope:** Inoculation of the bacteria into water of condensation at bottom of the slope of a nutrient agar, followed by anaerobic incubation for 24 hours yields a pure colony of *C. tetani* at top of the slope in the tube. This method is known as Fildes technique and is employed as a routine method for isolating pure colonies of *C. tetani*.

## ► Biochemical reactions

*C. tetani* shows following reactions:

- *C. tetani* has mild proteolytic activity but completely lacks saccharolytic activity.
- It does not ferment any sugars. It does not produce H<sub>2</sub>S and does not reduce nitrates.
- It is indole positive, but MR and VP negative.
- It produces a greenish fluorescence on MacConkey medium, which contains neutral red.

## ► Other properties

**Susceptibility to the physical and chemical agents:** *C. tetani* spores of different strains show a variable heat resistance. Most spores are killed by boiling at 100°C for 10–15 minutes and by autoclaving at 121°C for 20 minutes. They are also killed by 1% aqueous solution of iodine and 10% of hydrogen peroxide. The spores are resistant to most antiseptics. They are not killed by

5% phenol or 0.1% mercuric chloride solution. They can survive in soil for years.

**Typing:** *C. tetani* are classified into 10 serological types (types I to X) based on agglutination. All strains produce the same toxin. The toxin is neutralized by the standard antitoxin.

## Pathogenesis and Immunity

*C. tetani* is a noninvasive bacillus. It causes disease only by production of toxins, which are most important virulence factors (Table 29-3).

## ► Virulence factors

*C. tetani* produces the following toxins: (a) tetanolysin, (b) tetanospasmin, and (c) neurotoxin or nonspasmogenic toxin. Tetanolysin and tetanospasmin are two major toxins, which are pharmacologically and antigenically distinct. Nonspasmogenic toxin or neurotoxin is identified recently.

**Tetanospasmin:** Tetanospasmin is the toxin responsible for the clinical manifestations of tetanus. The toxin is produced during the stationary phase of growth but is released only after the lysis of bacteria.

- Tetanospasmin is a protein and is synthesized as a single polypeptide chain of molecular weight (MW) 151,000 Da. On release from the bacillus, the peptide is split by an endogenous protease into two chains: a light chain (A) of 52,000 MW protein and a heavy chain (B) of 93,000 MW protein; the two chains are joined by noncovalent forces of a disulfide bond.
- The purified toxin is extremely potent. The minimum lethal dose (MLD) of toxin for animals is 50–75 × 10<sup>-6</sup> mg and for humans is 130 ng.
- Different species of animals show a wide variety in their susceptibility to tetanospasmin. Birds and reptiles are highly resistant to the toxin. Horses are most susceptible to the toxin followed by guinea pigs, goats, and rabbits in the descending order.
- The toxin acts by preventing the release of neurotransmitters, such as gamma-aminobutyric acid (GABA), glycine, etc., thereby specifically blocking synaptic inhibition in the spinal cord. This leads to unregulated spread of impulses, inhibited anywhere in the central nervous system (CNS).
- The binding of toxin is irreversible.
- Tetanus toxoid is antigenic but nontoxic. Tetanus toxin is made into toxoid by treating it with formaldehyde.

TABLE 29-3

Virulence factors of *Clostridium tetani*

Virulence factors	Biological functions
Tetanospasmin	Potent heat labile toxin; prevents the release of neurotransmitters (e.g., GABA, glycine, etc.), hence blocks specific synaptic inhibition in the spinal cord. Motor neurons are left under no inhibitory control and undergo sustained excitatory discharge
Tetanolysin	Heat-stable hemolysin; unknown significance in pathogenesis of tetanus. Oxygen-labile hemolysin.
Neurotoxin	Nonspasmogenic and peripherally active neurotoxin of unknown significance

**Tetanolysin:** Tetanolysin is an oxygen- and heat-labile hemolysin. It is antigenically related to other clostridial hemolysins and streptolysin O. The toxin is of doubtful pathogenicity and appears not to play any role in the pathogenesis of tetanus.

**Neurotoxin:** This is a third toxin recently identified. It is a nonspasmogenic and peripherally active neurotoxin. The role of this toxin in pathogenesis of tetanus is not understood.

### ► Pathogenesis of tetanus

Tetanus is caused by entry of the *C. tetani* spores. Under anaerobic conditions, the spores germinate to vegetative form and subsequently produce toxins, such as tetanospasmin and tetanolysin, under favorable conditions of anaerobiosis. The conditions that favor anaerobiosis in tissues include wounds with low oxidation–reduction potential, such as those with (a) dead devitalized tissue, (b) a foreign body, or (c) active infection. Tetanospasmin is absorbed locally and at the nervous system peripherally at the myoneural junction and is transferred centripetally into neurons of the CNS.

- The heavy chain (100 kDa) of the toxin is responsible for specific binding to neural cells and for protein transport.
- The light chain blocks the release of two major inhibitory neurotransmitters, such as GABA and glycine. This leads to failure of inhibition of motor reflex responses to sensory stimulation. This results in generalized contraction of the agonist and antagonist musculature—the characteristics of a tetanic spasm in the absence of reciprocal inhibition.

The shortest peripheral nerves transmit toxin quickly to the CNS, which leads to early symptoms of facial distortion and back and neck stiffness.

The toxicity of tetanospasmin depends upon the route of administration of the toxin. The route of administration also modifies the course of clinical manifestation of the disease.

- Intraneural injection and injection directly into the CNS is most lethal.
- Intravenous, intramuscular, and subcutaneous injections are effective but toxin given orally is ineffective because toxin is destroyed by enzymes present in the gastrointestinal tract.

**Tetanus in experimental animals:** The experimental tetanus in animals, such as mice, is also dependent on the route of administration of toxins.

**Intramuscular injection of toxin:** This causes ascending tetanus. Intramuscular injection in one of the hind limbs is associated with appearance of tonic spasm of the muscles in the injected limb first. This is due to toxin acting on the segment of spinal cord.

The toxins act by preventing the inhibition or removing the nerve impulse, once they cross the synaptic junctions. The nerve continues to send impulses resulting in spasmodic contractions or tetani of the affected muscles.

Muscle stiffness is the early symptom, with jaw muscles often developing symptoms first. This condition is called **lock jaw**; with progression of disease, spasm develops in other muscles. The spasm, although brief, occurs frequently and causes

immense pain and exhaustion. This condition is called local tetanus. Subsequent spread of the toxin up the spinal cord causes ascending tetanus. In this condition, the opposite hind limb, trunk, and fore limbs are involved.

**Intravenous injection of toxin:** This causes descending tetanus. In this condition, spasticity develops first in the muscles of the head and neck and then spreads downward, which resembles naturally occurring tetanus in humans.

### ► Host immunity

Specific antibodies produced against tetanus toxin are protective. Antibodies specifically combine with free toxin and prevent the action of the toxin.

- Prevalence of protective immunity to tetanus is greater in children and in persons aged between 6 and 39 years.
- Protective immunity from tetanus decreases in older people. Serological study for immunity has shown a low level among elderly individuals in many countries. Approximately 50% of persons older than 50 years are nonimmune, because they never were vaccinated or did not receive appropriate booster doses.
- Clinical tetanus does not produce a state of immunity; hence, patients who survive the disease require active immunization with tetanus toxoid to prevent a recurrence of the disease.

## Clinical Syndromes

The incubation period of tetanus is variable ranging from few days to several weeks, but commonly 6–12 days. Duration of incubation period depends on: (a) distance of primary wound infection from the CNS, (b) the inoculating dosage of bacteria, (c) toxigenicity of bacteria, and finally (d) immune status of the host.

*C. tetani* causes tetanus, which can be of the following types: (a) generalized tetanus, (b) neonatal tetanus, (c) localized tetanus, and (d) cephalic tetanus.

### ► Generalized tetanus

Generalized tetanus is the most common form of tetanus. It occurs when the toxin produced at the wound site spreads through the lymphatics and blood to multiple nerve terminals. This is because the blood–brain barrier prevents direct entry of toxin to the CNS. The extent of the trauma varies from minor injury to contaminated crush injury. The incubation period varies from 7 to 21 days and depends on the distance of the site of wound from the CNS. Trismus or lock jaw is due to involvement of masseter muscle and is the most common and early sign of the disease. Difficulty in swallowing, irritability, and restlessness are the other early signs.

As the condition progresses, patients have generalized muscle rigidity with intermittent reflex spasms in response to stimuli, such as noise or touch. Tonic contractions cause **opisthotonus**, a condition characterized by flexion and adduction of the arms, clenching of the fists, and extension of the lower extremities. During these episodes, patients have intact sensorium and feel severe pain. The spasms can cause fractures, tendon ruptures, and acute respiratory failure. *Risus sardonicus* or characteristic

sardonic smile is a typical feature, which occurs due to continued contraction of facial muscles. The condition may progress for 2 weeks even with administration of antitoxin because of the time needed for intra-axonal antitoxin transport.

Prognosis of tetanus is dependent on (a) incubation period, (b) time from spore inoculation to first symptom, and (c) time from first symptom to first tetanic spasm. Tetanus with short incubation period is graver than tetanus with long incubation period. Recovery is slow and usually takes as long as 2–4 months.

### ► Neonatal tetanus

Neonatal tetanus is a generalized tetanus, resulting from infection of a neonate. It occurs primarily in underdeveloped countries and is a major cause of infant mortality. The infection occurs due to the use of contaminated blade, knife, or other materials to cut or dress the umbilical cord in newborns, particularly of unimmunized mothers.

Usually at the end of the first week of life, infected infants become irritable, feed poorly, and develop rigidity with severe spasms. The condition has a very poor prognosis for survival. The mortality rate exceeds 70%.

### ► Localized tetanus

Localized tetanus is an unusual form of tetanus. The disease is confined to the extremity with a contaminated wound and occurs when only the nerves supplying the affected muscle are involved. The condition is characterized by rigidity of muscles, caused by a dysfunction in the interneurons that inhibit the alpha-motor neurons of the affected muscles. No CNS involvement occurs in localized tetanus, and it has very low mortality rates.

### ► Cephalic tetanus

Cephalic tetanus is a variation of localized tetanus. The condition usually occurs following head injury or occurs with infection of the middle ear. Incubation period is very short (1–2 days).

Symptoms may be localized or may become generalized and include isolated or combined dysfunction of the cranial motor nerves, most frequently the seventh cranial nerve. This particular condition has a poor prognosis.

## Epidemiology

### ► Geographical distribution

Tetanus is a disease found worldwide. The condition is predominantly a disease of underdeveloped countries. The disease is common in areas where soil is cultivated, in rural areas, in warm and damp climates, and during summer months. Tetanus affects all age groups, with the highest prevalence among newborns and young people. Overall, the annual incidence of tetanus is 0.5–1 million cases, mostly in underdeveloped countries. Neonatal tetanus accounts for 50% of the tetanus-related deaths in developing countries.

### ► Habitat

*C. tetani* organisms are found in soil, in animal feces, and, occasionally, in human feces as well as on inanimate objects. The spores may survive for years in some environments and are resistant to disinfectants and even to boiling for 20 minutes.

### ► Reservoir, source, and transmission of infection

*C. tetani* spores are the infective form of the bacteria. Soil, animal feces, and, occasionally, human feces as well as inanimate objects contaminated with spores are the primary source of infection.

Risk factors for neonatal tetanus include unvaccinated mothers, home delivery, and unhygienic cutting of the umbilical cord. Animal dung, clarified butter, etc., applied to the umbilical stump are the other risk factors for neonates.

The following types of wounds are more susceptible to tetanus: (a) grossly contaminated wounds; (b) wounds exposed to saliva or feces; (c) stellate, ischemic, or infected wounds; (d) deep (>1 cm) wounds; as well as (e) avulsions, punctures, or crush injuries.

## Laboratory Diagnosis

Laboratory diagnosis of tetanus like that of *C. perfringens* infection is made on the basis of clinical presentation. Laboratory diagnosis is carried out in the patients only to confirm the clinical diagnosis.

### ► Specimens

The specimens include excised bits of tissue from the necrotic depths of wounds. Swabs from the wounds are not good specimens.

### ► Microscopy

Gram staining of smears for *C. tetani* is useful but frequently unsuccessful and also unreliable.

## Key Points

Demonstration of typical drumstick bacilli in wound tissue (Fig. 29-5, Color Photo 30) is not diagnostic of tetanus. This is because:

- *C. tetani* may be present in some wounds without causing tetanus.
- Furthermore, it may not be possible to distinguish by microscopy *C. tetani* from morphologically similar *Clostridium* species, such as *C. tetanomorphum* and *Clostridium sphenoides*.

### ► Culture

The specimens are inoculated on a blood agar and incubated anaerobically for 24–48 hours. *C. tetani* produces swarming growth, which spreads throughout the plate. The specimens



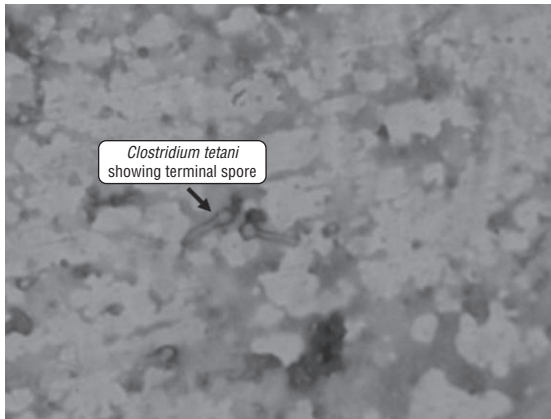

**FIG. 29-5.** Gram-stained smear showing drumstick appearance of *Clostridium tetani* ( $\times 1000$ ).

are also inoculated to a set of three tubes of RCM media, one of which is heated at 80°C for 15 minutes, the second for 5 minutes, and third is left unheated and are incubated at 37°C for 24–48 hours. Subsequently, subculture is made daily on blood agar for up to 4 days. From the swarming edges of the colonies on blood agar, *C. tetani* is isolated in pure culture. Culture is positive in only 30% of cases of tetanus because tetanus is caused only by a few organisms, and many organisms are killed when exposed to air during processing of specimens.

### ► Identification of bacteria

The identifying features of *C. tetani* are distinguished by their morphology, cultural, and toxigenic characteristics (Box 29-2).

### Toxigenicity testing

Strains of *C. tetani* are tested for production of toxin by following tests:

**In vitro neutralization test on blood agar:** The test is performed on a blood agar containing 4% agar. High percentage of agar is used to inhibit swarming by *C. tetani*. One-half of the medium is inoculated with tetanus antitoxin (1500 units per mL), while the other half of the medium does not contain any antitoxin. Strains of *C. tetani* are stab-inoculated on each half of the plate and incubated anaerobically for 48 hours. The colonies of *C. tetani* show hemolysis on part of the blood agar without any antitoxin, but do not show any hemolysis on part of the agar with antitoxins. This is due to inhibition of hemolytic activity of the toxin by antitoxin present in the agar. The test is useful to demonstrate identification of the colony as *C. tetani*, but is not a reliable test.

**In vivo neutralization test in mice:** In this test, a 0.2 mL of a 2–4 days old cooked meat culture of *C. tetani* is inoculated into the root of the tail of two mice each, one of which is protected with 1000 units of tetanus antitoxin 1 hour before the test (control animal). The other mouse is not protected with any antitoxin (test animal). Symptoms of ascending tetanus due to tetanospasmin produced by *C. tetani* develop in test animals 12–24 hours after inoculation of the bacteria. The symptoms begin in mouse with

## Box 29-2 Identifying features of *Clostridium tetani*

1. Extremely fine translucent film of growth, which tends to swarm over the entire surface of the agar.
2. Produce alpha-hemolytic colonies initially on blood agar, which on prolonged incubation become beta-hemolytic due to production of tetanolysin.
3. Gram-positive bacilli with prominent terminal spores (drumstick appearance) in the Gram-stained smear of the colony.
4. Motile (except type VI) and capsulated bacteria.
5. Do not ferment any sugars.
6. Toxigenicity testing in mouse—a reliable method of identification of the colony as *C. tetani*.

stiffness in the tail, which proceed rapidly to the leg on inoculated side, the opposite leg, trunk, and forelimbs, in that order. The animal usually dies within 48 hours. No symptoms appear in the inoculated control animal. Toxigenicity testing in mouse is a reliable method of identification of the colony as *C. tetani*.

### ► Serodiagnosis

Serological tests are not used because neither antibodies to tetanus toxin nor the tetanus toxin are detectable in serum of patients.

### ► Other tests

**The spatula test:** This is most useful and a simple bedside diagnostic test for tetanus. This test is based on touching the oropharynx with a spatula or tongue blade. This touch typically elicits a gag reflex and the patient tries to expel the spatula (negative test). The patients develop a reflex spasm of the masseters and bite the spatula if tetanus is present (positive test). The test is 100% specific and 94% sensitive.

## Treatment

Treatment of tetanus is (a) initial supportive therapy, (b) wound debridement and care, (c) stopping toxin production, (d) neutralizing unbound toxin, (e) controlling disease manifestations, and (f) managing complications. It includes antibiotics therapy and human immunoglobulin therapy.

### ► Antibiotics therapy

Antibiotics are used to prevent multiplication of *C. tetani* in the wound, thus halting the production and release of toxins. Metronidazole is the current antimicrobial drug of choice with penicillin as an alternative treatment. Tetracycline is an alternative drug for patients who are allergic to penicillin or metronidazole. Clindamycin, erythromycin, and vancomycin are the other antimicrobials used in the treatment of tetanus.

### ► Human immunoglobulin therapy

Human tetanus immunoglobulin (TIG) is given to neutralizes unbound tetanus toxins, and also to prevent circulating

tetanus toxin from reaching the CNS. A single total dose of 3000–6000 IU is given intramuscularly for children and adults immediately at the time of diagnosis. A lower dose of 500 IU for infants with tetanus neonatorum has been effective.

In countries where TIG is not available, equine tetanus antitoxin (ATS) is used for the purpose. Tetanus antitoxin is administered intramuscularly as a single dose of 50,000–100,000 IU after appropriate testing for sensitivity and desensitization, if necessary. Part of this dose (20,000 IU) is always given intravenously.

## Prevention and Control

### ▶ Active immunization

Tetanus is completely preventable by active immunization.

- Active immunization by vaccination with tetanus toxoid is the key to preventing tetanus.
- Vaccination is carried out by toxoids, which are available either as plain toxoid or adsorbed on aluminum hydroxide or phosphate.
- The toxoid is given alone or in combination with diphtheria toxoid and acellular pertussis (whooping cough) (DTaP or triple) vaccine.

### Vaccines

The tetanus toxoid and the triple vaccine containing tetanus toxoid are very safe and effective. The toxoid stimulates production of protective antibody response in virtually all immunocompetent subjects. Many studies have shown the presence of protective serum antibody levels in up to 90% of immunized people 15 years after vaccination. Slight fever and soreness, redness, or swelling at the injection site are very minor and infrequent side effects. Patients cannot contract tetanus from the vaccine.

Primary prevention of tetanus is achieved by vaccination with the triple vaccine at ages 2, 4, 6, and 12–18 months and 4–6 years. A tetanus-diphtheria (dT) booster dose is administered at 11–12 years and thereafter every 10 years.

For the primary immunization of unimmunized children 7 years or older, tetanus toxoid is administered as two doses 4–6 weeks apart, with a third dose 6–12 months later. Booster doses are administered every 10 years or at the time of major injury if it occurs more than 5 years after a dose.

Vaccination with tetanus toxoid is recommended for:

- (a) All adults who have not had a booster dose in the last 10 years,
- (b) Adults who have recovered from tetanus, and
- (c) Adults who have never received immunization against tetanus.

### Immunization for prevention of neonatal tetanus:

Neonatal tetanus is prevented by increasing immunization in women of childbearing age, especially pregnant women, and by improving maternity care. For previously unimmunized pregnant women, tetanus toxoid is given twice during pregnancy, 4–6 week apart, preferably in the last two trimesters and again at least 4 weeks before delivery. Maternal antitetanus antibodies

are passed to the fetus, and this passive immunity is effective for many months after birth of the child.

### ▶ Passive immunization

Human TIG is used for passive immunization. In countries where TIG is not available, ATS is also used for the purpose. Passive immunization is carried out by intramuscular administration of 250–500 IU of TIG or by subcutaneous or intramuscular injections of 1500 units of ATS. Passive immunization is recommended for:

- (a) nonimmunized individuals and
- (b) for those whose immunization status is uncertain whenever a wound is contaminated or likely to have devitalized tissue.

### ▶ Combined immunization

Secondary prevention of tetanus is achieved postexposure through appropriate wound cleansing and debridement, and combined immunization. Combined immunization is carried out by simultaneous administration of (a) human TIG or the ATS and (b) tetanus toxoid. It is indicated if the patient has not been previously immunized with a series of at least three doses of toxoid.

## *Clostridium botulinum*

*C. botulinum* is a heterogeneous group of spore-forming, anaerobic, Gram-positive bacteria causing botulism, a paralytic disease with the presentation of food poisoning.

## Properties of the Bacteria

### ▶ Morphology

*C. botulinum* shows following features:

- *C. botulinum* is Gram-positive in young cultures less than 18 hours' old. The organism may be Gram-negative in cultures after 18 hours of incubation.
- The bacillus measures  $5 \times 1 \mu\text{m}$ .
- The bacillus is motile by the presence of peritrichous flagella, and possesses subterminal and oval bulging spores.
- The bacteria are noncapsulated.

### ▶ Culture

*C. botulinum* is a strict anaerobe. The bacteria grow at an optimum temperature of 35°C. The bacteria can grow on a wide range of media including blood agar, Mueller–Hinton agar, and RCM media. On blood agar, *C. botulinum* produces large, irregular, and semitransparent colonies with irregular fimbriate border. They produce spores when grown in alkaline glucose gelatin media at 20–25°C.

### ▶ Biochemical reactions

*C. botulinum* shows following reactions:

- *C. botulinum* is identified by its ability to ferment glucose, hydrolyze gelatin, digest protein, and produce the enzyme lipase.
- Production of enzyme lipase is demonstrated by formation of iridescent film on *C. botulinum* colonies grown on egg yolk agar.

### ► Other properties

**Susceptibility to physical and chemical agents:** *C. botulinum* organisms as well as spores are highly resistant. They are resistant to boiling at 100°C for several hours, but are killed by pressure cooking at 120°C for 10 minutes. *C. botulinum* types B, E, and F spores are relatively less heat resistant. The toxins are destroyed by boiling for 10 minutes or cooking at 80°C for 30 minutes.

**Typing:** *C. botulinum* is a heterogeneous group of spore-forming, anaerobic, Gram-positive microorganisms. They are classified into seven types (A to G) on the basis of the antigenic specificities of their toxins.

### Pathogenicity and Immunity

*C. botulinum* organisms are noninvasive. They cause disease primarily by production of an exotoxin, the botulinum toxin, which is the major virulence factor of the bacteria (Table 29-4).

### ► Virulence factors

**Botulinum toxin:** Botulinum toxin is a protein with molecular weight of 70,000 Da. The toxin is relatively heat stable. It is inactivated at 80°C for 30–40 minutes and at 100°C for 10 minutes. The toxin is similar in structure and function to the tetanus toxin, except only in the site of action.

- Botulinum toxin differs from other exotoxins in that it is produced only on death and autolysis of the bacteria, but not when the bacilli are alive.
- Botulinum toxin is a progenitor protein synthesized intracellularly in the bacteria. It consists of two subunits A and B. Subunit A is the light chain and is a neurotoxin. Subunit B is heavy chain, which prevents neurotoxin part (chain A) from being inactivated by acidity of the stomach. More than three B subunits may be present in the toxin.
- Botulinum toxin is the most potent naturally occurring toxin known to mankind. The lethal dose for mice is 0.000,000,033 mg and for human beings is 1–2 g. Botulinum toxin is lethal at a femtomolar level of doses of  $10^{-12}$  g/kg, making botulinum toxin 15,000–100,000 times more potent than serin gas.
- The toxin can also be toxoided.

TABLE 29-4

#### Virulence factors of *Clostridium botulinum*

Virulence factors	Biological functions
Botulinum toxin	All toxins except C2 are neurotoxins; the neurotoxin acts specifically on cholinergic nerves; it acts by preventing the release of acetyl choline at the synapses and at the neuromuscular junctions

Depending on the immunological differences in the toxins produced by *C. botulinum*, eight antigenically distinct botulinum toxins (types A, B, C1, C2, D, E, and F, G) have been described. These different toxins appear to be identical in their biological functions but differ immunologically. The toxins are specifically neutralized only by their homologous antiserum.

- A single strain of bacteria produces only one toxin.
- In rare instances, a single strain may produce more than one toxin. All toxins except C2 are neurotoxins.

The neurotoxin acts specifically on cholinergic nerves. It acts by preventing the release of a neurotransmitter, acetylcholine, at the synapses and at the neuromuscular junctions. It causes atrophy of the muscles at the site of the infection, but the neurons regenerate in 2–4 months of recovery.

Toxins A and B are the most potent toxins. The production of toxins by *C. perfringens* types C and D appears to be mediated by bacteriophages.

### ► Pathogenesis of botulism

Botulism is caused in various ways:

- Food-borne botulism is caused by direct ingestion of botulinum toxin in a contaminated food.
- Infant botulism is caused by toxins produced by *C. botulinum* present in the intestine.
- Wound botulism is caused by toxins produced in a *C. botulinum* contaminated wound.

From the stomach and small intestine, toxins are absorbed, as they are not denatured by digestive enzymes. The toxin enters the vascular system and is transported to peripheral cholinergic nerve terminals, such as neuromuscular junctions, cholinergic parasympathetic nerve endings, and some peripheral ganglia.

The toxin binds to receptor sites on presynaptic motor nerve terminals and causes blockade of neuromuscular conduction. The toxin then enters the nerve terminal and inhibits the release and transmission of acetylcholine in cholinergic nerve fibers. The toxin irreversibly binds to the neurons.

The nervous, gastrointestinal, and endocrine-metabolic systems are mainly affected. Because the motor end plate responds to acetylcholine, ingestion of botulinum toxin results in hypotonia, manifesting as descending symmetric flaccid paralysis of the respiratory muscles.

### Clinical Syndromes

*C. botulinum* causes the following forms of botulisms: (a) food-borne botulism, (b) infant botulism, and (c) wound botulism.

### ► Food-borne botulism

Food poisoning occurs on ingestion of preformed toxins in food contaminated with *C. botulinum*. The severity of illness varies from a mild to a very serious disease resulting in death within 24 hours. The incubation period is short, varies from 12 to 36 hours after ingestion of the contaminated food.

- Vomiting, nausea, dry mouth, constipation, abdominal pain, blurred vision with fixed dilated pupils are the initial signs. Fever, typically is absent.
- The disease progresses to as bilateral descending weakness of the peripheral muscles, leading to flaccid paralysis.
- Fever, typically is absent.

Death is due to respiratory paralysis and occurs in 1–7 days after onset of the disease. Case fatality varies from 10% to 25%. The use of intensive medical support facilities in the hospitals has reduced the fatality rate, which were as high as 20% seen earlier.

### ▶ Infant botulism

Infant botulism unlike food poisoning is caused by neurotoxins produced *in vivo* by *C. botulinum* that have colonized the gastrointestinal tract of the infants. The initial symptoms are nonspecific and include constipation, lethargy, weakness, weak and altered cry, loss of head control, etc. The condition may progress to flaccid paralysis and respiratory arrest. The infants excrete toxins in their feces. The infant mortality due to infant botulism is relatively very low (11–20%).

### ▶ Wound botulism

Wound botulism occurs following heavy contamination of wounds with soil or water containing *C. botulinum* spores. The incubation period is 4–14 days with a mean of 10 days. Wound botulism is similar to food-borne botulism except that the incubation period is longer and no gastrointestinal symptoms are present. Often, the wound appears quite benign.

## Epidemiology

Human botulism is found worldwide.

### ▶ Habitat

*C. botulinum* is ubiquitous. It is found in soil and water worldwide. Spores of *C. botulinum* type A or B are distributed widely in the soil and have been found throughout the world.

### ▶ Geographical distribution

- *C. botulinum* types A, B, E, and rarely F and G toxins cause human disease. Types C and D cause avian and nonhuman mammalian disease. Infant botulism is more common than food-borne botulism. Food-borne botulism is caused by *C. botulinum* types A, B, and F; very rarely E types.
- Wound botulism is very rare and is caused by *C. botulinum* type A strains.

### ▶ Reservoir, source, and transmission of infection

*C. botulinum* spores are responsible for causing botulism:

1. Preserved food especially homemade, canned meat and meat products in Europe, canned vegetables in America, and preserved fish in Japan, contaminated with preformed

toxin are the main sources of infections for food-borne botulism.

2. Honey and other food contaminated with spores of bacteria are the sources of infection for infant botulism.
3. Soil and water heavily contaminated with spores are sources of infection for wound botulism.

**Transmission of infection:** Botulism is transmitted in following ways:

- Wound botulism occurs as a result of contamination of wound with spore-forming *C. botulinum*. The condition occurs in (a) people with traumatic injury involving contamination with soil, (b) in people who chronically abuse intravenous drugs (e.g., black tar heroin), and (c) in women after cesarean delivery (very rare). The condition can also occur even after antibiotics are administered to prevent wound infection.
- Food-borne botulism results from the ingestion of preformed neurotoxins in the food. Consumption of food contaminated with even very small amounts of these toxins has resulted in full-blown disease. During the last 20 years, toxin A has been the most frequent cause of food-borne outbreaks; toxins B and E follow in frequency.
 

High-risk foods include home-canned or home-processed low-acid fruits and vegetables; fish and fish products; and condiments, such as relish and chili peppers. Commercially prepared foods and improperly handled fresh foods may occasionally cause outbreaks of botulism.
- Infant botulism occurs following ingestion of *C. botulinum* spores present in infant food such as honey. The spores then germinate to toxin-producing vegetative form that colonize the infant gut. Toxin that is produced in and absorbed from the gut causes the clinical disease.

## Laboratory Diagnosis

The clinical diagnosis of botulism requires a high degree of clinical suspicion. The diagnosis is suspected in an afebrile patient with progressive descending paralysis, especially in the presence of gastrointestinal manifestations. Laboratory diagnosis of the condition rests on demonstration of *C. botulinum* bacilli or toxins:

1. Diagnosis of food-borne botulism is made by demonstration of *C. botulinum* in food by culture and by demonstration of toxin in food or feces.
2. Diagnosis of infant botulism is confirmed by isolation of bacilli and detection of botulinum toxin in feces of the patient.
3. Diagnosis of wound botulism is made by isolation of or by detection of toxin of botulinum in wound pus and exudates.

### ▶ Specimens

Feces, vomitus, or gastric aspirate are collected for diagnosis of all the forms of botulism. Tissue from wound is collected for wound botulism.

## ► Microscopy

Gram staining of the smears made from food and other specimens may show Gram-positive spore-bearing *C. botulinum*.

## ► Demonstration of toxin

*C. botulinum* toxin can be demonstrated in foods, feces, and other specimens by serum toxin bioassay, enzyme-linked immunosorbent assay, and polymerase chain reaction.

**Serum toxin bioassay:** The toxin is demonstrated in food or feces by neutralization test in mice. In this method, food filtrate in sterile saline is inoculated intraperitoneally into two mice. One mouse is protected with polyvalent botulinum antitoxin (control animal) and another is not protected by any antitoxin (test animal). If test animal dies but control animal remains healthy, the test is considered positive and is suggestive of the presence of toxin in the specimen. This is a useful test to demonstrate toxin during early stages of food botulism. However, enzyme-linked immunoassays and polymerase chain reaction are still at the experimental stage.

## ► Culture

In food-borne botulism, *C. botulinum* may be isolated from suspected contaminated food and from the feces by culture. Food culture is performed first by heating the specimens at 80°C for 10 minutes. This is done to destroy all the vegetative forms of the bacteria. The heated specimens are then cultured on RCM media and incubated in anaerobic conditions followed by subculture on blood agar. Anaerobic incubation facilitates germination of the spores to vegetative forms of the bacteria.

### Key Points

- Demonstration of *C. botulinum* in feces, vomitus, or gastric aspirate by culture is highly suggestive of food-borne botulism, because intestinal carriage is rare. Culture is positive in approximately 60% of cases. Toxin also can be demonstrated in food or feces for diagnosis of food-borne botulism.
- Demonstrations of *C. botulinum* in pus culture and detection of botulinum in wound pus and exudates are highly suggestive of wound botulism.
- Isolation of bacilli and detection of botulinum toxin in feces of the infant confirms the diagnosis of infant botulism.

## ► Identification of bacteria

The identifying features of *C. botulinum* colonies are summarized in Box 29-3.

## Treatment

Treatment of botulism involves (a) initial supportive therapy, (b) neutralizing unbound toxin by specific antitoxins, and (c) stopping toxin production by use of antibiotics.

### Box 29-3 Identifying features of *Clostridium botulinum*

1. Produces large, irregular, and semitransparent colonies with irregular fimbriate border on blood agar.
2. Gram-positive bacilli with subterminal and oval bulging spores in the Gram-stained smear of the colony.
3. Motile and capsulated bacteria.
4. Ferments glucose, hydrolyze gelatin, and digest protein.
5. Produces enzyme lipase.
6. Serum toxin bioassay in mouse—a reliable method of detection of toxin of *C. botulinum*.

**Antitoxin therapy:** A trivalent A-B-E botulinum antitoxin serum is used for specific treatment of botulism. The sera contain antibodies against *C. botulinum* types A, B, and E, which act by binding and neutralizing the toxins present in the serum. The trivalent botulinum antitoxin is administered immediately in patients who are symptomatic with high clinical suspicion of food-borne botulism and wound botulism. Antitoxin is useful, even when given several weeks after toxin ingestion, because circulating toxin has been detected in serum as long as 4 weeks later. Nevertheless, antitoxins do not neutralize toxin already bound to neuromuscular junctions. Although antitoxin can slow disease progression, it has no effect on established neurologic pathology.

**Antibiotics therapy:** Antibiotics are used to prevent multiplication of *C. botulinum* in the gastrointestinal tract and in the wound, thus halting production and release of toxins. Metronidazole is the current antimicrobial drug of choice with penicillin as an alternative treatment.

## Prevention and Control

Food-borne botulism is best prevented by high-temperature pressure cooking, which kills spore present in fruits and vegetables. Storing the food in refrigerator at 4°C or in an acidic pH prevents germination of spores, if present, to vegetative bacterial form. Strict compliance of recommended home-canning techniques is essential. Wound botulism is prevented by immediate and a thorough debridement of contaminated wounds. Cessation of drug use by drug addicts prevents wound botulism due to intravenous drug abuse. Infant botulism is prevented by avoiding administration of honey to infants.

### *Clostridium difficile*

*C. difficile* was first described in 1935 from the feces of healthy newborns and was initially not thought to be a pathogen. It was named *difficile* because it grows slowly and is difficult to culture. It is a long slender Gram-positive, anaerobic bacillus bearing large, oval, and terminal spores. It is nonhemolytic, saccharolytic, and mild proteolytic.

- *C. difficile* is the causative agent of antibiotic-associated diarrhea and colitis. *C. difficile* produces two antigenically distinct toxins: toxin A and toxin B. Toxin A is an enterotoxin and toxin B is a cytotoxin.
- Both the toxins contribute to pathogenesis of *C. difficile* colitis and diarrhea in humans.
- Both are proteins which bind to specific receptors present in the mucosa of the intestine. The toxins gain entry into cells and catalyze a specific alteration of Rho proteins and glutamyl transpeptidase (GTP)-binding proteins that help in actin polymerization, cytoskeletal architecture, and cell movement.

*C. difficile* colonization occurs by the ingestion of the spores. Hence, outbreaks of *C. difficile* diarrhea may occur in hospitals where contamination with spores is more common.

Normal flora of the gastrointestinal tract resists colonization and overgrowth with *C. difficile*. Antibiotic therapy is the key factor that alters the normal bacterial flora of the intestine. The use of antibiotics suppresses the normal flora of the intestine and facilitates colonization and multiplication of *C. difficile* as well as production of toxins that cause inflammation of the mucosa and damage.

*C. difficile* causes malaise, anorexia, and mild-to-moderate diarrhea, occasionally with abdominal cramping. Diarrhea develops in most patients during or shortly after starting antibiotics. However, in 25–40% of patients, diarrhea may occur 10 weeks after completing antibiotic therapy. It is associated with formation of pseudomembranes and, occasionally, adherent yellowish-white plaques on the intestinal mucosa. The condition in rare cases presents with an acute abdomen and fulminant life-threatening colitis.

*C. difficile* spores are heat-resistant, which can persist in the environment for several months to years. *C. difficile* is present in 2–3% of healthy adults and in 70% of healthy infants. *C. difficile* infection is more common in old people; this may be due to increasing susceptibility of mucosal flora to colonization by the bacteria and disease. The infection is uncommon in infants and young children, although they frequently harbor the bacteria and its toxins.

The diagnosis of *C. difficile* colitis is suspected in any patient with diarrhea who has received antibiotics within the previous 2 months and/or when diarrhea occurs 3 days or more after hospitalization.

Diagnosis of *C. difficile* diarrhea is made by demonstration of *C. difficile* toxin in the feces by stool cytotoxin test and by enzyme-linked immunosorbent assay:

- The stool cytotoxin test is the test of choice. In this test, diarrheal stool is filtered and then inoculated to Hep-2 and human diploid cell cultures. The demonstration of a cytopathic effect that is neutralized by specific antiserum indicates the presence of the toxin (positive test). Absence of cytopathic effect is considered a negative test. The test has a high sensitivity of 94–100% and a specificity of 99%. Disadvantage of the test are that it is expensive and it requires a tissue culture facility.
- Several enzyme immunoassays with moderate sensitivity (69–87%) and high specificity (99–100%) are now commercially available for rapid detection of the toxin and diagnosis. The latex agglutination test has been employed to detect the presence of glutamate dehydrogenase, produced by *C. difficile*, for diagnosis of *C. difficile* diarrhea. The test shows a low sensitivity (48–59%) but a high specificity (95–96%).
- Stool cultures, however, are not useful due to the presence of nontoxigenic strains of *C. difficile* in feces.

No treatment is necessary for asymptomatic carriers. Stopping the use of causative antibiotics may be the only treatment necessary for those with mild antibiotic-associated diarrhea without fever, abdominal pain, or leukocytosis. This approach allows for reconstitution of the normal colonic microflora and significantly reduces the risk of relapse.

Patients with more severe diarrhea or colitis require treatment with antibiotics. Metronidazole is the drug of choice. Vancomycin and bacitracin are also effective. More than 95% of patients respond to 10 days of treatment with oral vancomycin, or oral or intravenous metronidazole.



## CASE STUDY

An 18-year-old college student came to a hospital with a complaint of facial spasm. He has been unable to eat for 2 days due to severe pain in his jaw. Examination revealed trismus and risus sardonicus. The student gave a history of playing football for his college team, during which he had sustained a minor knee injury with abrasions 6 days earlier. He did not visit any doctor earlier or receive any toxoid for the injury. He did not remember of receiving any booster vaccination with tetanus toxoid in last many years. A clinical diagnosis of tetanus was made.

- What laboratory tests should be performed to confirm the diagnosis?
- Should treatment wait until laboratory results are available?
- Describe the pathogenesis of tetanus.
- What are the vaccines available against tetanus in humans?

# Nonsporing Anaerobes

## Introduction

The anaerobic cocci are a heterologous group of bacteria that typically colonize the skin and the mucous membranes. The taxonomical classification of these cocci has undergone several modifications and importantly, the classification has been simplified now. The anaerobic cocci are divided into (a) anaerobic Gram-positive cocci and (b) anaerobic Gram-negative cocci.

## Anaerobic Cocci

### Anaerobic Gram-Positive Cocci

Most of the important anaerobic Gram-positive cocci belong to the genus *Peptostreptococcus*. The cocci are small and measure 0.2–2.5  $\mu\text{m}$  in size. Many of the cocci are aerotolerant and grow well in air supplemented with 10%  $\text{CO}_2$ . These Gram-positive cocci are normal inhabitants of the oral cavity, gastrointestinal tract, genitourinary tract, and skin. These bacteria on spreading from these sites to other normally sterile sites may cause several clinical infections:

- (a) Bacteria colonizing the skin can cause cellulitis and infections of the soft tissue;
- (b) Bacteria in the intestine can cause intra-abdominal infection;
- (c) Bacteria in the genital tract can cause pelvis abscess, salpingitis, and endometritis; and
- (d) Bacteria invading blood stream can cause infections in bones and visceral organs.

*Peptostreptococcus anaerobius* is most commonly associated with puerperal sepsis and *Peptostreptococcus magnus* with abscess. The laboratory diagnosis of the infection caused by these cocci depends on the isolation of the bacteria by culture. Clinical specimens are inoculated on blood agar or other enriched agar and incubated for at least 5–7 days in anaerobic conditions, unlike other anaerobic bacteria that typically grow in 1–2 days. While collecting the specimens, care should be taken to prevent contamination of the specimens with *Peptostreptococcus* that normally colonize the mucosal membrane and skin surface.

The cocci are often found in large numbers in pus from suppurative lesions; hence Gram staining of pus smears is frequently helpful in diagnosis.

The cocci are generally sensitive to imipenem, chloramphenicol, and metronidazole. They are intermediately sensitive to broad-spectrum cephalosporins, tetracyclines, and clindamycin. They are

resistant to streptomycin and gentamicin. Most infections are mixed, the cocci being present along with anaerobic Gram-negative bacilli and clostridia. Hence, broad-spectrum antibiotics effective against all these pathogens are usually given for treatment.

### Anaerobic Gram-Negative Cocci

The genus *Veillonella* spp. includes anaerobic Gram-negative cocci of varying size occurring in pairs, short chains, or clusters. These cocci normally colonize the mouth, intestines, and genitourinary tract. *Veillonella parvula* is the species frequently reported from clinical specimens, but its role in causation of the disease is not known.

## Anaerobic Bacilli

### Anaerobic Gram-Positive Bacilli

The anaerobic non-spore-forming Gram-positive bacilli are a heterogeneous group of facultatively anaerobic or strictly anaerobic bacteria that characteristically colonize the skin and mucosal membranes. The group includes many genera, but few of these are associated with clinical infections (Table 30-1). *Propionibacterium* spp., *Lactobacillus* spp., *Mobiluncus* spp., and *Actinomyces* spp. are well known to cause human infections. *Eubacterium* spp. and *Bifidobacterium* spp. are isolated in clinical specimens; they rarely cause human disease.

#### ▶ *Propionibacterium*

*Propionibacterium* species are anaerobic or aerotolerant bacteria found as part of the normal flora of the skin, oropharynx, conjunctiva, external ear, and female genital tract.

- They are Gram-positive bacilli that are frequently present in short chains and clumps.
- They are nonmotile and are catalase positive.
- They ferment carbohydrates with production of propionic acid, hence named *Propionibacterium*.
- *Propionibacterium* are not fastidious. They can grow on nutrient agar or other simple media. However, they grow slowly, take 3–5 days to produce colonies.

*Propionibacterium acnes* and *Propionibacterium propionicus* are two important species of clinical importance. *P. acnes* is the most common causative agent of acne in teenagers and young adults. The species also causes infections of heart valves or

TABLE 30-1

## Human infections caused by anaerobic Gram-positive and Gram-negative bacilli

Bacteria	Diseases
<i>Propionibacterium</i> spp.	Acne and opportunistic infections
<i>Mobiluncus</i> spp.	Bacterial vaginosis and opportunistic infections
<i>Actinomyces</i> spp.	Actinomycosis (thoracic, abdominal, pelvic, central nervous system, cervicofacial)
<i>Lactobacillus</i> spp.	Endocarditis and opportunistic infections
<i>Bifidobacterium</i> spp.	Opportunistic infections
<i>Eubacterium</i> spp.	Opportunistic infections
<i>Bacteroides fragilis</i>	Soft tissues infections, intra-abdominal infections, gynecological infections, and bacteremia
<i>Bacteroides ureolyticus</i>	Head and neck infections
<i>Bacteroides thetaiotaomicron</i>	Intra-abdominal infections and bacteremia
<i>Fusobacterium nucleatum</i>	Head and neck infections
<i>Fusobacterium necrophorum</i>	Head and neck infections
<i>Porphyromonas asaccharolytica</i>	Head and neck infections
<i>Porphyromonas gingivalis</i>	Head and neck infections
<i>Prevotella intermedia</i>	Head and neck infections
<i>Prevotella melaninogenica</i>	Head and neck infections and intra-abdominal infections
<i>Prevotella bivia</i>	Gynecological infections
<i>Prevotella disiens</i>	Gynecological infections

joints and cerebrospinal fluid shunts and cellulitis. *P. acne* is a common contaminant in blood and cerebrospinal fluid culture. Isolation of *Propionibacterium* from clinical specimens needs to be interpreted in light of the clinical condition. The lesions in acne develop within the sebaceous follicles; hence are not related to effectiveness of the cleanliness of the skin.

The condition is treated best with topical application of benzoyl peroxide and antibiotics. The bacteria are sensitive to erythromycin and clindamycin.

### ► *Lactobacillus*

Members of the genus *Lactobacillus* are facultatively anaerobic bacilli. They are commonly found in the mouth, stomach, and intestine and in the adult vagina. They are commonly isolated in blood and urine cultures. The presence of lactobacilli even in high numbers in urine culture usually represents contamination of bacteria from the urethra, in which lactobacillus are most commonly present. Lactobacilli usually do not cause infection of the urinary tract, because they fail to grow in the urine.

Lactobacilli can invade the blood stream during (a) endocarditis, (b) opportunistic septicemia in immunocompromised host, and (c) transient bacteremia following genitourinary procedure.

Combined therapy with penicillin and aminoglycoside has proved effective against infections caused by lactobacilli. Lactobacilli are resistant to vancomycin.

### ► *Mobiluncus*

*Mobiluncus* species are obligate anaerobes. They are Gram-negative or Gram-variable curved bacilli with tapering ends. Despite their Gram-variable properties, they are classified as Gram-positive bacteria because they have a cell wall of Gram-positive bacilli, and they lack endotoxin. The bacteria are fastidious; they grow slowly on enrichment media, such as blood agar containing either rabbit or horse blood. They are found as part of the normal flora of the genitourinary tract. In women with bacterial vaginitis, they are found in very high numbers. The exact role of the bacteria as a causative of bacterial vaginosis is not known. Typical Gram-staining features of the bacteria are diagnostic. They are sensitive to erythromycin, ampicillin, clindamycin, and vancomycin but resistant to colistin.

### ► *Bifidobacterium* and *Eubacterium*

*Bifidobacterium* spp. and *Eubacterium* spp. are commonly found in the oropharynx, large intestine, and vagina. They are usually isolated as contaminants. Repeated isolation of these bacteria in absence of other pathogens may suggest their role as possible agents of infection.

## Anaerobic Gram-Negative Bacilli

Anaerobic Gram-negative bacilli of clinical importance belong to the family Bacteroidaceae. This is classified into four genera: *Bacteroides*, *Fusobacterium*, *Porphyromonas*, and *Prevotella*. All these are Gram negative. *Prevotella* species are very small and elongated, while *Fusobacterium* species are long and thin. A surface lipopolysaccharide (LPS) is the major component of the cell wall.

### ► Properties of anaerobic Gram-negative bacilli

*Bacteroides* species have now been reorganized. Earlier, genus *Bacteroides* consisted of almost 50 species. Now, asaccharolytic pigmented species have been reclassified into the genus *Porphyromonas* (Greek word, meaning “purple”) and saccharolytic bile sensitive species in the genus *Prevotella*. The genus *Bacteroides* now includes *Bacteroides fragilis* and closely related other species, such as *Bacteroides distasonis*, *Bacteroides vulgatus*, and *Bacteroides thetaiotaomicron*. *B. fragilis* is the prototype of endogenous anaerobic pathogen that colonizes humans. *B. fragilis* is pleomorphic in size and shape, having a typical Gram-negative cell wall. A surface lipopolysaccharide (LPS) is major component of the cell wall. The LPS of *B. fragilis* lacks endotoxin activity unlike the LPS of *Fusobacterium*. *B. fragilis* is surrounded by a polysaccharide capsule. *Bacteroides* are nonfastidious and grow rapidly in culture, while other anaerobic Gram-negative bacilli are fastidious and grow slowly (3 days and more) in the culture media.

The ability of the bacteria to (a) inactivate immunoglobulins, (b) cause tissue destruction, and (c) resist oxygen toxicity plays an important role in the pathogenesis of anaerobic infections. *B. fragilis* and other anaerobic Gram-negative bacilli produce a wide variety of virulence factors, which play a major role in the pathogenesis of disease (Table 30-2). The presence



TABLE 30-2

**Virulence factors of anaerobic Gram-negative bacilli**

Virulence factors	Biological functions
Capsule ( <i>Bacteroides fragilis</i> and <i>Prevotella melaninogenica</i> )	Antiphagocytic and adhesins
Fimbriae ( <i>Bacteroides fragilis</i> and <i>Porphyromonas gingivalis</i> )	Adhesins
Lipopolysaccharides ( <i>Fusobacterium</i> spp.)	Antiphagocytic
Hemagglutinin ( <i>Porphyromonas gingivalis</i> )	Adhesins
Lectin ( <i>Fusobacterium nucleatum</i> )	Adhesins
Succinic acid (many species)	Antiphagocytic
Immunoglobulin (Ig) A, IgM, IgG proteases ( <i>Porphyromonas</i> spp. and <i>Prevotella</i> spp.)	Antiphagocytic
Superoxide and catalase (many species)	Resist oxygen toxicity
Other enzymes, such as protease, collagenase, phospholipase, neuraminidase, heparinase, glucuronidase, hemolysins, fibrinolysins, etc. (many species)	Cause destruction of tissues

of polysaccharide capsule in *B. fragilis* helps the bacteria to adhere to peritoneal surfaces more effectively than other anaerobes. The capsular polysaccharide is antiphagocytic; it inhibits phagocytosis by polymorphonuclear leukocytes. Succinic acid and other short-chain fatty acids provided by these bacteria during anaerobic metabolism also exhibit phagocytosis and intracellular killing of bacteria.

**Key Points**

*B. fragilis* and other species possess pili by which they adhere to the epithelial cells. *Bacteroides* produce the enzymes catalase and superoxide dismutase, which inactivate the hydrogen peroxide and superoxide-free radicals, thereby protecting these anaerobic bacteria when exposed to oxygen. The other factors that facilitate spread of these anaerobic bacteria are trauma, tissue necrosis, impaired circulation, and presence of foreign bodies.

*B. fragilis* and other anaerobic Gram-negative bacteria usually colonize the skin, mouth, nasopharynx and upper respiratory tract, intestine, and vagina in large numbers. As resident bacterial flora, they prevent colonization by other pathogenic organisms and help in digestion of food. These organisms, however, cause infections when they spread from their usual sites to other parts of the body that are usually sterile.

*B. fragilis* causes more than 80% intra-abdominal infections, even though *B. distasonis* and *B. thetaiotaomicron* are found predominantly in the gastrointestinal tract. These two species merely cause any abdominal infections.

*B. fragilis* is the common anaerobic bacteria that cause abscess in the genitourinary tract. It is the most important anaerobic bacteria causing pelvic inflammatory disease, endometritis, abscess, and other infections of the female genital tract.

**Other Gram-negative anaerobes:** Other Gram-negative anaerobes, such as *Fusobacterium* spp., *Prevotella* spp., *Porphyromonas* spp., and non-*B. fragilis* spp. cause up to 50%

of chronic infections of the sinuses and ears; and most of periodontal infections.

**► Clinical manifestations of anaerobic Gram-negative bacilli infections**

The anaerobic infections are characterized by the presence of polymicrobial mixture of organisms with more than one anaerobic and aerobic bacteria being responsible for the infection. The characteristic putrid pus with a nauseating and foul odor, pronounced cellulitis, and not so common fever and toxemia are suggestive of anaerobic infections caused by these Gram-negative bacilli.

**► Laboratory diagnosis of anaerobic Gram-negative bacilli infections**

This depends on the isolation of Gram-negative anaerobic bacteria in clinical specimens. Isolation of these bacteria need careful interpretation since most of the anaerobes are commensals and constitute part of the normal flora of the skin and mucous surface. The mere presence of the bacteria does not suggest their causative role.

The specimens, as far as possible, are not collected from their normal resident sites. The specimens are also not allowed to dry because drying reduces number of bacteria. Hence, specimens are always kept in a moist environment. The specimens are collected and transported to the laboratory in an oxygen-free system to minimize contact with air. In the laboratory, the specimens are inoculated into specific media promptly and incubated in anaerobic condition. Pus and other biological fluids are collected in glass vials or bottles with airtight caps. Collection of fluid and other aspiration in airtight syringes is a better method of collection. After collection, the needle is plunged into sterile rubber container and sealed. Swabs are not the specimen of choice for anaerobic infections but if collected are sent in Stuart's transport medium.

**Key Points**

Microscopic examination of clinical specimens by Gram staining is useful for the diagnosis of Gram-negative anaerobic infections. Gram-stained findings of pus smear showing pleomorphic, Gram-negative bacilli, polymicrobial flora, and numerous pus cells are useful preliminary diagnosis of anaerobic infections. Direct fluorescent examination may show bright red fluorescence of *Prevotella melaninogenica*.

Many selective media are used, which facilitate isolation of Gram-negative anaerobic bacteria. Freshly prepared blood agar with yeast extract, hemin, vitamin K, and neomycin is useful for culture of anaerobes. The culture plates are incubated in anaerobic jar at 37°C in the presence of 10% CO<sub>2</sub>. The gas-pack system, which provides a better method of anaerobiosis, is now used widely. Most *Bacteroides* grow within 24–48 hours, but some other Gram-negative anaerobes, such as *Fusobacterium*, grow slowly; hence, culture plates require longer period of incubation. The specimens are cultured in parallel because many aerobic bacteria are also involved in polymicrobial infections.

Gas-liquid chromatography of specimen is also occasionally useful for identifying metabolic end products of anaerobic bacteria to supplement laboratory diagnosis.

### ► Management of Gram-negative anaerobic bacterial infections

This depends mainly on surgical intervention and antibiotic therapy. Metronidazole is the antibiotic of choice for treatment of infection caused by *Bacteroides* and other Gram-negative

anaerobes. The anaerobic Gram-negative bacilli are also sensitive to penicillin, clindamycin, cephalosporins, and chloramphenicol.

Most of the *B. fragilis*, *Prevotella*, and *Porphyromonas* species are resistant to penicillins and to many cephalosporins due to production of beta-lactamase. The resistance is overcome by treating with high concentration of carbenicillin, piperacillin, imipenem along with beta-lactamase inhibitors. *Bacteroides* show plasmid-mediated resistance to clindamycin.



#### CASE STUDY

A 42-year-old man was admitted to a hospital with abdominal pain and tenderness and fever. On examination, the patient was clinically suspected to be having appendicitis. He was operated. On surgery, a ruptured appendix and a copious volume of foul-smelling pus were found. The pus was sent to microbiology laboratory for aerobic and anaerobic culture. The culture was positive for *Bacteroides fragilis*, *Enterococcus faecalis*, and *Escherichia coli*.

- Which organisms are responsible for intra-abdominal infections and produce foul smelling pus?
- How will you diagnose *B. fragilis* infection?
- What are the virulence factors of *B. fragilis*?
- Which antibiotics will be useful to treat *B. fragilis* infection?

# Coliforms

## Introduction

Enterobacteriaceae organisms are ubiquitous bacteria. They are distributed worldwide and found in the soil, water, and plants. They are also present as part of the normal intestinal flora of humans and animals. Members of this family are nonsporing, nonacid fast, and moderately sized Gram-negative bacilli. They are motile by peritrichous flagella or nonmotile without any flagella. They are aerobic and facultatively anaerobic and grow readily on ordinary media, ferment sugars with production of acid and gas or acid only, reduce nitrate to nitrite, and are catalase-positive but oxidase-negative. The oxidase test is an important test by which the members of the Enterobacteriaceae can be distinguished from many other fermentative and nonfermentative Gram-negative bacilli. Members of the family show a very wide biochemical and antigenic heterogeneity among themselves. Enterobacteriaceae organisms cause a variety of diseases in humans (Fig. 31-1):

1. Some members of the family, such as *Salmonella* species, *Shigella* species, etc., always cause diseases in humans.
2. Other species, such as *Escherichia coli*, *Klebsiella pneumoniae*, *Proteus mirabilis*, etc., found as normal intestinal flora in humans can also cause infections in other sites of the human body.
3. In addition to these, there is another group of Enterobacteriaceae organisms, which are found as normal commensals

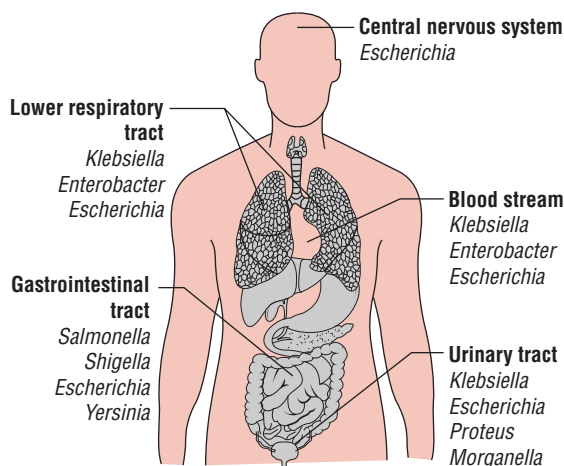

**FIG. 31-1.** Schematic diagram showing variety of diseases caused by the members of the family Enterobacteriaceae in humans.

in humans but become pathogenic when they acquire virulence factor genes through plasmids, bacteriophages, or pathogenicity islands. *E. coli* associated with gastroenteritis in humans is one such example.

Enterobacteriaceae organisms are acquired from humans (*Salmonella* Typhi, *Shigella* species, etc.), animals (*Salmonella* species and *Yersinia* species), or through endogenous infection. In the latter, the pathogen (*E. coli*) can spread from primary site of infection to virtually all the sites of the body.

## Classification

Earlier, the characteristics of the colonies on commonly used medium (such as the MacConkey medium) were used to identify and classify the members of family Enterobacteriaceae. The colonies were classified as lactose-fermenting bacteria (*Escherichia* spp., *Klebsiella* spp., *Enterobacter* spp., *Citrobacter* spp., etc.) or nonlactose-fermenting bacteria (*Salmonella* spp., *Shigella* spp., *Proteus* spp., etc.) depending on the ability of the bacteria to ferment lactose. This was used as a practical method in a routine diagnostic laboratory.

The current practice, however, is to classify bacteria on the basis of a number of morphological, biochemical, serological, and DNA-based characteristics. Bergey's manual, Kauffmann, and Edwards-Ewing's classifications are the three widely used methods for classification of the members of family Enterobacteriaceae. All these methods have nearly the same type of approach for the classification of bacteria. As per these methods, the family Enterobacteriaceae is divided into many major groups or tribes. Each tribe consists of one or more genera or subgenera. Each genus consists of many species, which are classified into different types, such as biotypes, serotypes, colicin types, bacteriophage types, etc. As per the new classification (Ewing 1986), the family Enterobacteriaceae has been classified into eight tribes as given in Table 31-1. The genus consisting of *Yersinia pestis*, the causative agent of a major disease plague, is included under the tribe Yersiniaceae in the family Enterobacteriaceae (Table 31-1). Important properties distinguishing different genera of the family Enterobacteriaceae are summarized in Table 31-2.

Human infections caused by common members of the family Enterobacteriaceae are summarized in Table 31-3.

**Escherichia**

*Escherichia* are animal and human intestinal pathogens. The genus *Escherichia* consists of five species: *E. coli*, *Escherichia fergusonii*, *Escherichia hermannii*, *Escherichia vulneris*, and *Escherichia blattae*. Of these species, *E. coli* is the most common and most important species causing infection in humans. *E. coli* is further subdivided into biotypes and serotypes based on O, H, and K antigens.

**Escherichia coli**

*E. coli* has been recognized as harmless commensal and also as a versatile pathogen. *E. coli* in humans causes a broad spectrum of diseases. It is an important cause of enteric illness, urinary tract infection (UTI), neonatal sepsis, and neonatal meningitis. Hemolytic uremic syndrome (HUS) is a serious complication of enteric infection with certain *E. coli* strains.

TABLE 31-1

**Ewing's classification of the family Enterobacteriaceae**

Tribe		Genus/Genera
Tribe I	Escherichieae	<i>Escherichia</i> <i>Shigella</i>
Tribe II	Edwardsiellae	<i>Edwardsiella</i>
Tribe III	Salmonelleae	<i>Salmonella</i>
Tribe IV	Citrobactereae	<i>Citrobacter</i>
Tribe V	Klebsielleae	<i>Klebsiella</i> <i>Enterobacter</i> <i>Serratia</i> <i>Hafnia</i>
Tribe VI	Proteeae	<i>Proteus</i> <i>Morganella</i> <i>Providencia</i>
Tribe VII	Yersinieae	<i>Yersinia</i>
Tribe VIII	Erwinieae	<i>Erwinia</i>

TABLE 31-3

**Human infections caused by common members of the family Enterobacteriaceae**

Bacteria	Diseases
<b><i>Escherichia</i> spp.</b>	Gastrointestinal tract infections
	Urinary tract infections
	Blood stream infections
	Lower respiratory tract infections
	Central nervous system infections
<b><i>Shigella</i> spp.</b>	Gastrointestinal tract infections
<b><i>Salmonella</i> spp.</b>	Gastrointestinal tract infections
	Blood stream infections
<b><i>Klebsiella</i> spp.</b>	Urinary tract infections
	Lower respiratory tract infections
	Blood stream infections
<b><i>Proteus</i> spp.</b>	Urinary tract infections
<b><i>Enterobacter</i> spp.</b>	Lower respiratory tract infections
	Blood stream infections
<b><i>Morganella</i> spp.</b>	Urinary tract infections
<b><i>Yersinia</i> spp.</b>	Gastrointestinal tract infections
	Blood stream infections

TABLE 31-2

**Important properties distinguishing members of the family Enterobacteriaceae**

	<i>Escherichia</i>	<i>Klebsiella</i>	<i>Enterobacter</i>	<i>Salmonella</i>	<i>Shigella</i>	<i>Serratia</i>	<i>Hafnia</i>	<i>Edwardsiella</i>	<i>Citrobacter</i>	<i>Proteus</i>
Motility	+	-	+	+	-	+	+	+	+	+
Acid from glucose	+	+	+	+	+	+	+	+	+	+
Gas from glucose	+	+	+	+	-	V	+	+	+	V
Indole	+	-	-	-	-	-	-	+	V	V
H <sub>2</sub> S	-	-	-	+	-	-	-	+	V	+
Urease	-	+	V	-	-	V	-	-	V	V
Citrate	-	+	V	+	-	V	+	-	+	+
PPA	-	-	-	-	-	-	-	-	-	+
Lysine decarboxylase	+	+	V	+	-	V	+	+	-	-
Arginine dihydrolase	V	-	V	V	-	-	-	-	-	-
Ornithine decarboxylase	V	-	+	+	-	V	+	+	V	V

Note: V means variable results in different species or strains. *Salmonella* Typhi does not produce gas from sugars. *Shigella sonnei* ferments lactose and sucrose late.

## Properties of the Bacteria

### ► Morphology

*E. coli* shows the following features:

- *E. coli* is a Gram-negative bacillus, which measures around  $1-3 \times 0.4-0.7 \mu\text{m}$  in size.
- The bacilli are arranged singly or in pairs.
- They are motile due to the presence of peritrichous flagella.
- Some strains are nonmotile. Some strains of *E. coli* may be fimbriated. The fimbriae are of type I (hemagglutinating and mannose-sensitive) and are present in both motile and nonmotile strains.
- Some strains of *E. coli* isolated from extraintestinal infections possess polysaccharide capsule. They do not form any spores.

### ► Culture

*E. coli* is an aerobe and a facultative anaerobe. It grows at a temperature range of 10–40°C (optimum 37°C) and a pH of 7.2. The bacteria grow on a wide range of media including Mueller–Hinton agar, nutrient agar, blood agar, and MacConkey agar. Primary isolation can be made on nutrient agar and blood agar.

**Nutrient agar:** *E. coli* on nutrient agar after 18 hours of incubation at 37°C produces large, circular, low convex, grayish white, moist, smooth, opaque or partially translucent colonies (smooth or *S* forms). These smooth colonies are easily emulsifiable in saline. The rough or *R* forms produce rough colonies with an irregular dull surface. These colonies are often autoagglutinable in saline. The smooth to rough variation (*S*–*R* variation) is associated with the loss of surface antigens and also with the loss of virulence and occurs as a result of repeated subculturing.

**MacConkey medium:** *E. coli* produces bright pink flat colonies due to lactose fermentation. Many strains, especially those isolated from pathologic conditions, produce beta-hemolytic colonies on blood agar. They do not grow on selective media, such as DCA (deoxycholate citrate agar) or SS (Salmonella–Shigella) agar, used for the culture of salmonellae and shigellae.

**Liquid broth culture:** *E. coli* produces turbid growth with a deposit, which disperses completely on shaking.

### ► Biochemical reactions

*E. coli* shows following reactions:

1. *E. coli* ferments lactose, glucose, mannitol, maltose, and many other sugars with the production of acid and gas. They do not ferment sucrose. Some strains of *E. coli* are late lactose or nonlactose fermenters.
2. They do not liquefy gelatin, do not produce hydrogen sulfide ( $\text{H}_2\text{S}$ ), or do not utilize urea. Some variant strains of *E. coli* produce  $\text{H}_2\text{S}$ .
3. The indole, methyl red (MR), Voges–Proskauer (VP), and citrate utilization tests, generally referred to as the “IMViC” tests, are four important biochemical tests widely used in the classification of enterobacteria. *E. coli* is indole and MR positive, and VP and citrate negative (IMViC++--) (Fig. 31-2, Color Photo 31).

4. Some strains of *E. coli* are late lactose or nonlactose fermenters. Ability to produce  $\text{H}_2\text{S}$  (positive variants) and utilize citrate by *E. coli* are controlled by transmissible plasmids.

### ► Other properties

**Susceptibility to physical and chemical agents:** *E. coli* is inhibited by the presence of 7% sodium chloride in salt media used for isolation of staphylococci. Growth of the bacteria is also inhibited by sodium selenite in selenite broth, sodium tetrathionate in tetrathionate broth, and brilliant green in brilliant green tetrathionate broth.

## Cell Wall Components and Antigenic Structure

### ► Lipopolysaccharide (LPS)

The heat-stable lipopolysaccharide (LPS) is the major cell wall antigen of *E. coli*. The LPS consists of three components: (a) the genus-specific somatic O polysaccharide, (b) a core polysaccharide common to all Enterobacteriaceae (common antigen), and (c) lipid A.

*E. coli* organisms possess four major antigens (Fig. 31-3): H or flagellar antigen, O or somatic antigen, K or capsular antigen, and F or fimbrial antigens.

**H or flagellar antigen:** The H antigens are heat- and alcohol-labile proteins present on the flagella. The H antigens are genus specific and usually are not shared by other enterobacteria. All of the H antigens are present as monophasic, but very rarely as diphasic. A total of 75 “H” antigens have been recognized so far.

**O or somatic antigen:** O antigens occur on the surface of the outer membranes and are determined by specific sugar sequences on the cell surface. O antigen is an LPS complex and is an integral part of the cell wall. It is heat stable, resistant to boiling up to 2 hours and 30 minutes. Till now, 173 (1, 2, 3, etc. up to 173) O antigens have been described.

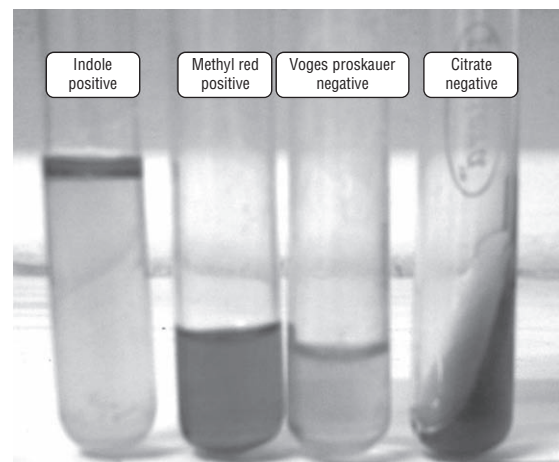
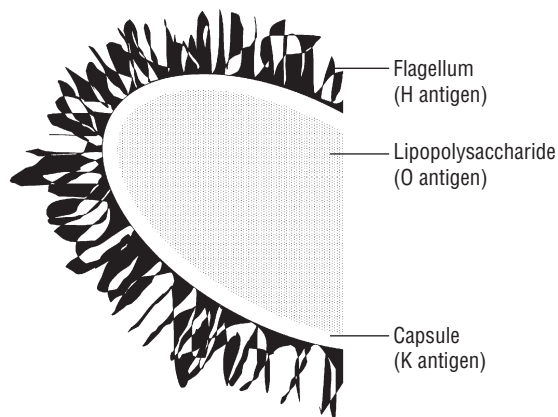

FIG. 31-2. IMViC reaction.



**FIG. 31-3.** Schematic diagram showing antigenic structure of *Escherichia coli*.

- Somatic O polysaccharide antigen shows cross-reactions with related genera (*Shigella*, *Salmonella*, *Yersinia*, and *Citrobacter*) in the family Enterobacteriaceae.
- The O antigen also shows cross-reaction with individual *E. coli* O antigens. The O antigens are detected by agglutination with specific antibodies.

**K or capsular antigen:** The heat-labile K antigen is the acidic polysaccharide antigen present in the “envelope” or microcapsule (K for *Kapsel*, German for capsule) of the bacteria.

- K antigen encloses the O antigen and may interfere with detection of the O antigens. This problem is overcome by boiling of the bacterial suspension to remove the K antigens.
- K antigens may also contribute to virulence by inhibiting phagocytosis. The K antigens are poor activators of complement. A total of 103 “K” antigens have been recognized.
- The K antigens are of two types: I and II. *E. coli* K I antigen shows cross-reaction with *Neisseria meningitidis* and *Haemophilus influenzae* capsular antigens. Differences between the two groups are summarized in Table 31-4.

**F or Fimbrial antigens:** These antigens are present on the fimbriae and are heat-labile proteins. A number of filamentous protein structures resembling fimbriae have been described in *E. coli*. These are K88, K99 antigens in *E. coli* strains causing diarrhea in animals or colonization factor antigens (CFA) in enterotoxigenic *E. coli* (ETEC) causing diarrhea in humans. These fimbrial antigens also contribute to virulence of the bacteria.

**TABLE 31-4**

**Differences between group I and II antigens of *Escherichia coli***

Properties	Group I antigen	Group II antigen
Susceptibility to heat at 100°C	Heat stable	Heat labile
Electrophoretic mobility	Low	High
Molecular weight	High (>100,000 Da)	Low (<50,000 Da)

## Antigenic typing

The serotyping of *E. coli* is based on three major groups of antigens: O antigens, K antigens, and H antigens. *E. coli* strains on the basis of O antigens are initially divided into a number of O groups. Each O group is then further divided into subgroups on the basis of K antigens. Finally, each of the subgroup includes strains with different H antigens. The antigenic pattern of a strain is recorded depending on the number of the particular antigen it carries (e.g., *E. coli* O111:K58:H2).

Different serotypes of *E. coli* are found in the normal intestine of humans and they do not have K antigens.

- The normal colon strains belong to the “early” O groups (1, 2, 3, 4, etc.).
- Enteropathogenic strains responsible for intestinal diseases belong to the “later” O groups (55, 86, 111, 112, etc.).

## Pathogenesis and Immunity

*E. coli* is an invasive bacterium. It colonizes the human intestine and, under specific conditions, directly invades the intestinal mucosa or produces toxins to cause intestinal infections. The bacteria can enter the blood stream and cause septicemia, meningitis, and other systemic manifestations. The bacteria, under certain conditions, directly invade urinary tract causing UTIs or cause intra-abdominal infections.

## Virulence factors

*E. coli* produces several virulence factors (Table 31-5), which include the following:

1. Common virulence factors associated with Enterobacteriaceae.
2. Specialized virulence factors associated specifically with *E. coli*.

**Common virulence factors associated with Enterobacteriaceae:** These include following factors: (a) fimbriae, (b) endotoxin, (c) capsule, and (d) sequestration of growth factors.

**Fimbriae:** Fimbriae promote virulence of *E. coli* and other members of the Enterobacteriaceae. The fimbriae are of two types:

- The first type is most common and is encoded by chromosomes, but is not related with virulence of the bacteria;
- The second type of fimbriae is encoded by plasmids, found only in small numbers, but is closely related with virulence of the bacteria.

Some of them do not occur as morphologically distinct structures but only as surface antigens. K88 and K99 antigens in *E. coli* strains causing diarrhea in animals or CFA in ETEC are examples of such fimbriae. The fimbriae play an important role in pathogenesis of UTI caused by *E. coli*.

**Endotoxin:** Endotoxin is a major virulence factor shared among all aerobic and some anaerobic Gram-negative bacteria including *E. coli*. Endotoxin is responsible for many of the systemic manifestations of Gram-negative bacteria caused by *E. coli* infections. Endotoxin also protects the bacillus from phagocytosis and from the bactericidal effects of complement.

TABLE 31-5

Virulence factors of *Escherichia coli*

Virulence factors	Biological functions
<b>Fimbriae</b>	Adherence of bacteria to gastrointestinal tract; of importance in urinary tract infections; and cause mannose-resistant hemagglutination
<b>Endotoxin</b>	Systemic manifestations of endotoxic shock, and protect the bacillus from phagocytosis and from the bactericidal effects of complement
<b>Capsule</b>	Antiphagocytosis protects <i>Escherichia coli</i> from phagocytosis. Protect the organism from serum killing
<b>Sequestration of growth factors</b>	The capability of <i>Escherichia coli</i> to compete for nutrients in host cells
<b>Adhesins</b>	Adhesins facilitate firm adhesion of <i>Escherichia coli</i> to the gastrointestinal or urinary tract mucosa, thereby preventing the bacteria being eliminated by the flushing action of voided urine or intestinal motility
<b>Hemolysins (HlyA)</b>	Important in the pathogenesis of disease caused by uropathogenic strains of <i>Escherichia coli</i>
<b>Enterotoxins</b>	
Shiga toxins	Cytotoxins
Heat stable toxin	Causes increased secretion of fluids
Heat labile toxin	Watery diarrhea due to hypersecretion of fluid into the lumen of the gut
<b>Siderophores</b>	Removes iron from mammalian iron transport proteins like transferrin and lactoferrin.

**Capsule:** Hydrophilic capsular K antigens protect *E. coli* from phagocytosis, which repel the hydrophobic phagocytic cell surface. The capsular antigens interfere with the binding of antibodies to the bacteria. However, the capsule is not effective in the presence of antibody to O or K antigen. Most strains of *E. coli* responsible for neonatal meningitis and septicemia possess the KI envelope antigen, a virulence factor similar to the group B antigen of meningococci. *E. coli* and other enteric bacteria capable of producing systemic infections are frequently resistant to serum killing. Capsule of the bacterium protects the organism from serum killing.

**Sequestration of growth factors:** The capability of the bacteria to compete for nutrients in host cells is an important property of virulent bacteria. *E. coli* and other enteric bacteria compete for iron, which is an important factor for their growth. The bacteria produce iron-chelating compounds, such as siderophores, enterobactin, and aerobactin, which facilitates the adsorption of iron by bacteria. Also the bacteria produce hemolysins, which lyse host erythrocytes, thereby releasing iron compounds for use by bacteria.

**Specialized virulence factors associated specifically with *E. coli*:** These include adhesins and exotoxins.

**Adhesins:** *E. coli* organisms possess numerous highly specialized adhesins. These adhesins include (a) CFAs (CFA/I, CFA/II, CFA/III), (b) aggregative adherence fimbriae (AAF/I, AAF/II, AAF/III), (c) bundle-forming pili (Bfp), (d) intimin, (e) P pili (binds to P blood group antigens), (f) Ipa (invasion plasmid antigen) protein, and (g) Dr fimbriae (bind to Dr blood group antigens). All these adhesins facilitate firm adhesion of *E. coli* to the gastrointestinal or urinary tract mucosa, thereby preventing the bacteria being eliminated by the flushing action of voided urine or intestinal motility.

**Exotoxins:** *E. coli* also produces two types of exotoxins: (a) hemolysins (HlyA) and (b) enterotoxins. Hemolysins are considered important in the pathogenesis of disease caused by

uropathogenic strains of *E. coli*. Enterotoxins are important virulent factors of *E. coli*. Three distinct types of *E. coli* enterotoxins have been recognized. These include (a) Shiga toxins (Stx-1, Stx-2), (b) heat-stable toxins (STa and STb), and (c) heat-labile toxins (LT-I and LT-II).

**Shiga toxins:** Shiga toxin (Stx) is so named because it is similar to the *Shigella dysenteriae* type 1 toxin in its physical, antigenic, and biological properties. The toxin is also named verocytotoxin or verotoxin (VT) because the toxin was first detected by its cytotoxic effect on Vero cells. Shiga toxins are of two types: Stx-1 and Stx-2. Both toxins are encoded by lysogenic bacteriophages. Both have one A subunit and five B subunits. Subunit B binds to a specific glycolipid (globotriaosylceramide, Gb3) present on the host cell. Both the toxins, although show same biological activity, are antigenically different. Stx-2 is not neutralized by the antibodies produced against Stx, unlike Stx-1. Shiga toxins demonstrate cytotoxicity activities in vero or HeLa cells. The toxin also shows enterotoxicity in rabbit ileal loops and paralytic lethality in mouse.

**Heat-stable toxin:** Heat-stable toxins (ST) are low-molecular-weight proteins and are of two types: STa and STb. STa is associated with disease in humans. STa is a small, methanol soluble, monomeric toxin that acts by activation of cyclic guanosine monophosphate (cGMP) in the intestine. STa binds to guanylate cyclase leading to an increase in the level of cGMP and subsequent increased secretion of fluids. The toxin acts very rapidly and causes accumulation of fluid in the intestines of infant mice within 4 hours of intragastric administration; hence infant mouse is a frequently used animal model for demonstration of STa. The toxin also causes accumulation of fluid in the intestine of neonatal but not weaned piglets.

STb is not associated with human diseases. STb unlike STa is not methanol soluble. The exact mode of action of STb is not known. The toxin causes accumulation of fluid in ligated intestinal loops of young piglets up to 9 weeks' old but not in infant mice.

**Heat-labile toxin:** Heat-labile toxin (LT) is a heat-labile protein. The toxin was first demonstrated by De and colleagues in 1956 in *E. coli* isolated from cases of adult diarrhea in adults in Kolkata. They demonstrated the toxin in the bacteria by the rabbit ileal loop method, the method used for detection of the cholera enterotoxin. LT is of two types: LT-I and LT-II. LT-I but not LT-II is associated with human diseases. LT-I is structurally and antigenically similar to cholera toxin. The LT-I toxin consists of one A subunit of molecular weight of 25,000 Da and five identical B subunits, each subunit measuring 11,500 Da. The B subunits bind to the GM1 gangliosides, same receptor as cholera toxin, as well as other surface glycoproteins on epithelial cells in the small intestine. This binding facilitates entry of subunit A into the cell by endocytosis. The A subunit has ADP (adenosine diphosphate)-ribosyl transferase activity by which it interacts with a membrane protein (Gs) that regulates adenylate cyclase. This results in an increase in cyclic adenosine monophosphate (cAMP) levels leading to an increased secretion of chloride and a decreased absorption of sodium and chloride. This ends in watery diarrhea due to hypersecretion of fluid into the lumen of the gut. The toxin also stimulates secretion of prostaglandin and production of inflammatory cytokines, resulting in further fluid loss. Genes for LT-I and STa are present on I transferable plasmid, which can also carry the genes for adhesins (CFA/I, CFA/II, CFA/III).

### ► Pathogenesis of *E. coli* infections

Most infections, such as UTIs and sepsis, are endogenous and are caused by the *E. coli* present in large numbers in the gastrointestinal tract of the same host. Other *E. coli* infections, such as gastroenteritis and neonatal meningitis, are caused by exogenous infections, i.e., acquired from outside.

**Urinary tract infections:** *E. coli* serotypes that are normally found in the feces are commonly responsible for urinary tract infections. UTI is an ascending infection in which the

bacteria that originate from the intestinal tract contaminate the urethra, ascend into the bladder, and may spread to the kidney or prostate.

**Nephritogenic strains:** Although most strains of *E. coli* can cause UTI, disease is more common with certain specific *E. coli* serogroups. These serogroups that cause UTI are known as nephritogenic strains, these include *E. coli* serotypes O1, O2, O4, O6, O7, O18, etc. These serotypes cause UTI, particularly because of their ability to produce adhesins (primarily P pili, AAF/I, AAF/III, and Dr), which bind to cells lining the bladder and upper urinary tract. This prevents elimination of the bacteria in voided urine. Only one serotype is usually isolated from urine at a time, though recurrences may be due to different serotypes. They also produce hemolysin HlyA, which lyses erythrocytes and also other cells, leading to release of cytokines and stimulation of an inflammatory response.

**Gastroenteritis:** Gastroenteritis is caused by exogenous infections acquired from water, food, or vegetables contaminated with fecal *E. coli*. The strains of *E. coli* that cause gastroenteritis are classified into the following six groups: (a) enteropathogenic *E. coli* (EPEC), (b) enterotoxigenic *E. coli* (ETEC), (c) enteroinvasive *E. coli* (EIEC), (d) enterohemorrhagic *E. coli* (EHEC), (e) enteroaggregative *E. coli* (EAEC), and (f) diffusely adherent *E. coli* (DAEC) (Table 31-6).

**Enteropathogenic *E. coli*:** EPEC is the major cause of infant diarrhea in tropical countries. Disease is rare in older children and adults. EPEC strains include O26, O55, O86, O111, O114, O119, O125, O126, O12, O128, and O142. EPEC causes infection by adhering to epithelial cells of the small intestine followed by destruction of the microvillus. The bacteria initially form microcolonies on the epithelial cell surface, in which the bacteria are attached to the host cells with help of cup-like pedestals. This attachment is facilitated by Bfp. This is followed by secretion of proteins by the bacterial type III secretion system into the host epithelial cell. Translocated intimin receptor is inserted into the epithelial cell membrane and

TABLE 31-6

Summary of gastroenteritis caused by *Escherichia coli*

Disease	Site and mechanisms of action	Causative organism
Traveler's diarrhea	Heat stable/heat labile toxin Acts on small intestine	Enterotoxigenic <i>Escherichia coli</i> (ETEC)
Infant diarrhea	Acts on small intestine	Enteropathogenic <i>Escherichia coli</i> (EPEC)
Dysentery	Invasion and destruction of epithelial cells Acts on large intestine	Enteroinvasive <i>Escherichia coli</i> (EIEC)
Hemorrhagic colitis (HC)	Shiga toxin	Enterohemorrhagic <i>Escherichia coli</i> (EHEC)
Hemolytic uremic syndrome (HUS)	Acts on large intestine	
Infant diarrhea	Adhesion Acts on small intestine	Enteroaggregative <i>Escherichia coli</i> (EAEC)
Infant diarrhea	Adhesion Acts on small intestine	Diffuse aggregative <i>Escherichia coli</i> (DAEC)
Chronic diarrheal disease	Acts on small intestine	Enteroaggregative <i>Escherichia coli</i> (EAEC)



serves as a receptor for intimin, an outer membrane bacterial adhesin of *E. coli*. Subsequently, the attached bacteria multiply and cause microvilli destruction, resulting in diarrhea due to malabsorption.

**Enterotoxigenic *E. coli*:** Diarrhea caused by ETEC is endemic in the developing countries, among all age groups of the population. This is also responsible for causing traveler's diarrhea in which individuals from developed countries visiting endemic areas often suffer from ETEC diarrhea. The disease is caused by consumption of fecally contaminated food or water. Person-to-person spread does not occur. Although plasmids with enterotoxin genes may be present in any strain of *E. coli*, diarrhea is caused by certain specific ETEC serogroups (O6, O8, O15, O25, O27, O167). These serotypes cause diarrhea because of their ability to produce heat-labile enterotoxins (LT-I, LT-II). LT-I, which is structurally similar to cholera toxin, produces cholera-like diarrhea in patients. The disease process is facilitated further by the presence of adhesins (primarily P pili, AAF/I, AAF/III, and Dr), which bind to intestinal mucosa.

**Enteroinvasive *E. coli*:** EIEC strains closely resemble shigellae in many ways: (a) EIEC strains are nonmotile, (b) they do not ferment lactose or ferment late with production of acid only, and (c) they do not decarboxylate lysine decarboxylase. These strains show cross-reactivity with O antigen of shigellae. These "atypical" *E. coli* strains were named earlier *Shigella alkalescens* under the "Alkalescens-Dispar Group" (resembling *Shigella flexneri* except in fermenting dulcitol and forming alkali in litmus milk) and *Shigella dispar* (late lactose fermenter like *Shigella sonnei* but indole positive). Currently, these have been renamed EIEC because they have the capacity to invade interstitial epithelial cells and also penetrate HeLa cells in tissue culture. The EIEC strains have the ability to invade and destroy the colonic epithelium, producing a disease characterized initially by watery diarrhea. This ability of *E. coli* to invade cells is determined by a large plasmid, which codes for outer membrane antigens called the "virulence marker antigens" (VMA). The bacteria lyse the phagocytes and multiply in the cell cytoplasm. This continuous process of epithelial cell destruction with inflammatory infiltration leads to the development of ulcers in intestine. Specific serogroups commonly associated with outbreaks of EIEC include O28 ac, O112 ac, O124, O136, O143, O114, O152, and O154.

**Enterohemorrhagic *E. coli*:** EHEC strains are the most common cause of gastrointestinal infections in the developed countries. These strains produce diarrheal disease, ranging in severity from mild uncomplicated diarrhea to fatal hemorrhagic colitis. Hemolytic uremic syndrome is a serious life-threatening complication in 10% of infected children below 10 years. The ingestion of as few as 100 bacilli can cause the disease. EHEC disease is most common in children below 5 years and in summer months. The condition occurs as a result of ingestion of water, unpasteurized milk or fruit juices, uncooked vegetables, and fruits contaminated with human or animal feces. The disease also occurs on consumption of undercooked ground beef or other meat products.

Serotypes O157:H7 and O26:H1 are the EHEC strains that commonly cause the disease. These strains produce Shiga toxins (i.e., Stx-1, Stx-2, or both), which are primarily responsible for the diarrheal diseases. Stx-2 is most commonly associated with HUS, a disorder characterized by acute renal failure, thrombocytopenia, and microangiopathic hemolytic anemia. Stx-2 causes destruction of glomerular endothelial cells, resulting in reduced glomerular filtration and acute renal failure. The toxins also stimulate production of tumor necrosis factor- $\alpha$  and interleukin-6, which contribute further to the disease process.

**Enteroaggregative *E. coli*:** EAEC strains are so called because they show a typical "stacked brick" arrangement on Hep-2 cells or glass due to their autoagglutination. Bundle-forming fimbriae of the bacteria (such as AAF/I and AAF/II), which are carried on a plasmid, mediate this process. These EAEC strains secrete a low-molecular-weight, heat-stable enterotoxin called enteroaggregative heat-stable enterotoxin-1 (EAST-1). EAEC increases mucus secretion, which forms a layer overlying the epithelium of the small intestine. This layer of biofilm traps the bacteria in epithelium of the small intestine. In animal experiments, they cause shortening of the microvilli, mononuclear infiltration, and hemorrhage. These strains are associated with persistent, watery diarrhea with dehydration in infants, especially in developing countries.

**Diffusely adherent *E. coli*:** DAEC strains cause watery diarrhea found primarily in children between 1 and 5 years of age. These strains are identified by their ability to adhere to cultured cells. They cause elongation of the microvilli with the bacteria trapped in the cell membrane.

**Septicemia:** Invasion of blood stream by *E. coli* may lead to septicemia. Septicemia is caused by *E. coli* strains associated with UTIs or intra-abdominal infections, such as peritonitis and abscesses following intestinal perforation. The mortality due to *E. coli* septicemia is high for patients with immunocompromised status, or for patients in whom the primary infection is in the abdomen or central nervous system (CNS).

**Neonatal meningitis:** *E. coli* along with group B streptococci are the major causes of infection of the CNS in infants of age 1 month. The disease is caused by *E. coli* strains that possess the KI capsular antigen, which are commonly present in the gastrointestinal tracts of pregnant women and newborn infants.

### ► Host immunity

Disease caused by EPEC is rare in older children and adults, presumably because they have developed protective immunity. Immunity develops to ETEC surface antigens in local adult populations; hence disease is confined to immunologically naïve travelers and weaning infants.

## Clinical Syndromes

*E. coli* causes (a) urinary tract infections, (b) gastroenteritis, (c) septicemia, (d) neonatal meningitis, and (e) other infections.

## ► Urinary tract infections

*E. coli* is the most common bacteria responsible for causing more than 80% of all community-acquired UTI. *E. coli* cause a wide range of UTIs, including uncomplicated urethritis or cystitis, symptomatic cystitis, pyelonephritis, acute prostatitis, prostatic abscess, or urosepsis. Uncomplicated cystitis occurs primarily in sexually active females who are colonized by uropathogenic strains of *E. coli*. Subsequently, the periurethral region is colonized by *E. coli* due to fecal contamination, and the bacteria reach the urinary bladder during sexual intercourse.

## ► Gastroenteritis

Different *E. coli* subtypes cause diarrheal illnesses of various types as follows:

- EPEC, EAEC, and DAEC cause watery diarrhea and dysentery. These conditions occur most often in developing countries. EPEC primarily affects infants and children. These strains cause acute watery diarrhea, which may cause dehydration or become chronic and lead to failure to thrive. EAEC and DAEC also cause diarrhea similar to that caused by EPEC.
- ETEC is distributed widely in areas with poor sanitation and is a ubiquitous contaminant of food and water sources. Hence, ETEC is the primary cause of traveler's diarrhea and the major cause of infantile diarrhea in underdeveloped countries. This is because immunity develops to ETEC surface antigens in local adult populations; hence disease is confined to immunologically naïve travelers and weaning infants. Incubation period is short, varies from 1 to 3 days. The condition manifests by the sudden onset of watery diarrhea without blood, mucus, or fecal leukocytes. Vomiting may be present, but most patients typically have no fever. This is a self-limiting condition and persists for less than 5 days.
- EIEC produces diarrhea and dysentery, disease similar to that caused by *Shigella* species. These strains cause watery diarrhea, dysentery, fever, vomiting, painful abdominal cramps, and tenesmus. Stools often contain blood and leukocytes.
- EHEC is an important cause of food-borne illness, particularly in developed countries, such as the United States and Canada. EHEC is a common microbiological flora of the intestine of cattle. Therefore, cattle are the primary reservoir of the EHEC strains that produce diarrhea in humans. The infection is acquired by ingestion of beef products or foods contaminated with cattle feces containing EHEC strains.

EHEC cause two distinctive syndromes: hemorrhagic colitis and hemolytic uremic syndrome (HUS) by producing two Shiga toxins. The Stx is responsible for the systemic complication and manifestations of the infection.

**Hemorrhagic colitis:** Incubation period varies from 1 to 5 days. The condition manifests as watery diarrhea to severe hemorrhagic colitis. Watery diarrhea is often accompanied by abdominal cramping and vomiting. In most patients, diarrhea becomes bloody in 1–2 days, but is usually not associated with fecal leukocytes. Fever is present in about a third of cases.

The infection typically lasts for 4–10 days. *E. coli* O157:H7, the most common strain causing EHEC diarrhea, has a small infective dose (around 100 bacilli) and spreads easily from child to child by the fecal–oral route. Gastroenteritis caused by *E. coli* is summarized in Table 31-6.

## Key Points

### *Hemolytic uremic syndrome (HUS)*

- Serious life-threatening complication, seen in 10–15% of children with EHEC diarrhea.
- Important manifestations include (i) microangiopathic hemolytic anemia, (ii) thrombocytopenia, and (iii) renal insufficiency.
- Typically develops in the second week of illness, after recovery from diarrhea.
- Presents with anemia, weakness, irritability, and oliguria or anuria.
- Chronic renal failure may develop in 10% of patients with HUS.
- Mortality rate—nearly 3–5%.
- Stool culture for EHEC is always negative in patients with HUS.

## ► Septicemia

*E. coli* causes septicemia, which is usually associated with UTI, especially in cases of urinary obstruction of any cause. The endotoxin or LPSs of the bacteria cause a systemic reaction that can lead to disseminated intravascular coagulation and even death. Mortality and morbidity associated with *E. coli* septicemia are same as that for other aerobic Gram-negative bacilli.

## ► Neonatal meningitis

*E. coli* is an important cause of meningitis in neonates. In adults, it occurs following neurosurgical procedures, CNS trauma, or complicating *Strongyloides stercoralis* hyperinfection involving the CNS. Neonatal meningitis has a high mortality rate of 8%.

## ► Other infections

These include intra-abdominal infections due to *E. coli*, often resulting from a perforated appendix, diverticulum, or due to intra-abdominal abscess, cholecystitis, and ascending cholangitis. Septic arthritis, endophthalmitis, sinusitis, osteomyelitis, endocarditis, or skin and soft tissue infections are the other pyogenic infections caused by *E. coli*.

## Epidemiology

### ► Geographical distribution

Many strains of diarrheagenic *E. coli* primarily affect populations in developing countries. There is a wide variation in the prevalence of these strains worldwide. EPEC, EAEC, and DAEC have been reported to occur most often in developing countries. ETEC is the primary cause of traveler's diarrhea and is the major cause of infantile diarrhea in poor and developing

countries. ETEC causes nearly more than 600 million cases of diarrhea every year and 700,000 deaths in children below 5 years. EHEC is an emerging cause of food-borne disease, particularly in the northern United States and Canada. Outbreaks of HUS in children that caused fatalities have also been documented in these countries.

### ► Habitat

Most strains of *E. coli* causing diseases in humans inhabit the human intestine. Few strains, such as EHEC, inhabit the cattle intestine also.

### ► Reservoir, source, and transmission of infection

Most *E. coli* infections with the exception of neonatal meningitis and gastroenteritis are endogenous. The infection is caused by the *E. coli* that constitute the patient's normal microbial flora. These bacteria cause infections, such as UTI, due to poor personal hygiene or when the patient's defenses are compromised. Diarrhea caused by *E. coli* is widespread in areas with poor sanitation, and infections are exogenous. Food and water contaminated with human or cattle feces are important sources of diarrheagenic *E. coli*. Ground beef, apple juice, and alfalfa sprouts contaminated with cattle feces are important sources of infection caused by enterohemorrhagic *E. coli* (e.g., O157:H7). Infection is acquired by ingestion of contaminated food or water. The usual source of *E. coli* in neonatal infections is the intestinal tract of the mother. The bacteria may also be acquired nosocomially, particularly in infants who are premature or who require mechanical ventilation. Humans and also cattle (for *E. coli* O157:H7) are reservoirs of infection.

## Laboratory Diagnosis

Laboratory diagnosis of *E. coli* infections is based on

1. Isolation of *E. coli* by culture.
2. Demonstration of toxins of diarrheagenic *E. coli*.

### ► Specimens

Urine is the specimen of choice for diagnosis of UTI caused by uropathogenic *E. coli*. Clean-voided midstream samples of urine are usually employed for culture. Catheterized urine and urine collected by suprapubic aspiration are also used in certain situations. Urine is a good medium for the growth of coliforms and other urinary pathogens, hence should be sent immediately to microbiology laboratory for processing the specimen. If delay of more than 1–2 hours is unavoidable, the specimen should be refrigerated. Other specimens include feces or rectal swabs for gastroenteritis, blood for septicemia, cerebrospinal fluid (CSF) for meningitis, sputum for pneumonia, or other body fluids, such as pus from wound, biliary and peritoneal abscesses caused by *E. coli*.

### ► Culture

Definitive diagnosis is based on the isolation of *E. coli* from various clinical specimens by culture. Urine culture is a very useful procedure for diagnosis of UTI. Stool culture is widely used to

isolate diarrheagenic *E. coli*. Culture of blood, CSF, and other specimens is also carried out depending on the clinical diseases caused by *E. coli*, as mentioned earlier.

**Urine culture:** Semiquantitative culture of urine for *E. coli* and other Gram-negative bacteria is the method most commonly used in a microbiology laboratory for identification of the bacteria from urine. In this method, a predetermined quantity of urine is inoculated on MacConkey and blood agar with a standardized inoculating loop. The loop is calibrated to deliver 0.05 mL of urine; hence 200 loopfuls of urine will deliver 1 mL of urine. The number of colonies that are obtained after overnight incubation of inoculated plates multiplied with 200 will be the approximate number of bacteria per milliliter of urine. For example, if the number of colonies on a MacConkey agar after overnight incubation is 500, the viable bacterial count/mL of urine will be  $(500 \times 200) 100,000$  or  $10^5$ . This forms the basis of significant bacteriuria suggested by Kass.

After incubation overnight at 37°C, pink, flat colonies of *E. coli* on the MacConkey agar and beta-hemolytic colonies on blood agar are identified by various biochemical tests (Box 31-1).

**Significant bacteriuria** concept suggested by Kass is based on the fact that a colony count exceeding 100,000 ( $10^5$ ) bacteria/mL of urine denotes significant bacteriuria and is suggestive of active UTI. Counts of 10,000 bacteria or less per milliliter are of no significance and are due to contamination of urine during voiding. Bacterial counts between 10,000 ( $10^4$ ) and 100,000 ( $10^5$ ) are infrequent when the sample is collected properly and processed promptly. Such results are considered equivocal and the culture is repeated.

## Key Points

- The concept of significant bacteriuria is applicable only for *E. coli* and other Gram-negative bacteria and for midstream urine specimen.
- It is not applicable for the urine specimens collected directly from urinary bladder by cystoscopy, and also for Gram-positive bacteria, such as *Staphylococcus aureus*, in which even low counts may be significant.

Interpretation of bacteriuria, however, requires caution and should always be with reference to clinical condition of the patient. Because UTI is a common problem and culture facilities are not available everywhere, several simple methods have been introduced for the presumptive diagnosis of

### Box 31-1

## Identifying features of *Escherichia coli*

1. Forms lactose fermenting pink colonies on MacConkey medium.
2. Produce a zone of hemolysis around colonies on blood agar.
3. Mostly motile (except EIEC).
4. Ferments lactose, glucose, and other sugars with production of acid and gas (except sucrose).
5. IMViC reaction (+ + - -).
6. Oxidase negative.

significant bacteriuria. These methods have been described in detail in Chapter 77.

After incubation overnight at 37°C, pink, flat colonies of *E. coli* on the MacConkey agar and beta-hemolytic colonies on blood agar are identified by various biochemical tests (Box 31-1).

**Other specimens for culture:** CSF culture positive for *E. coli* establishes the diagnosis of *E. coli* meningitis. Isolation of the organism from blood, pus, and other specimens is definitive for diagnosis of infections caused by *E. coli*.

### ► Demonstration of toxins of diarrheagenic *E. coli*

Laboratory diagnosis of diarrhea caused by diarrheagenic *E. coli* can be made by demonstration of the bacilli in feces by culture. The feces is collected from the patient in a sterile container and sent immediately to the laboratory. The fecal samples are inoculated directly on MacConkey and blood agar media. The plates are incubated at 37°C overnight and looked for the characteristic lactose-fermenting colonies on MacConkey and beta-hemolytic colonies on blood agar as described earlier.

Since *E. coli* is present as commensals in the intestine—hence is detected even in normal stool—it is essential to perform various diagnostic tests in order to consider it as diarrheagenic pathogenic *E. coli* strain. These strains are identified by (a) serotyping, (b) animal inoculation, (c) cytopathic effects in cell cultures, or (d) molecular methods.

**Identification of EPEC:** Specific serogroups of *E. coli* (O26, O55, O86, O111, O114, O119, O125, O126, O12, O128, and O142) are commonly associated with outbreaks of EPEC. Therefore, *E. coli* colonies isolated from feces on MacConkey agar are identified by agglutination tests with specific polyvalent and monovalent antisera. In this method, a saline suspension of *E. coli* colonies is made on the slide and mixed with a drop of specific polyvalent and monovalent antisera against EPEC serogroups. At least 10 colonies per plate should be tested. If isolated colonies are negative, the confluent growth is emulsified and tested. In a positive test, if *E. coli* colonies show agglutination with a specific serogroup (for example, O111) then the isolate is identified as *E. coli* of that serogroup (O111).

**Identification of ETEC:** Diagnosis of ETEC diarrhea depends on the demonstration of enterotoxin in *E. coli* isolates from stool, because toxin production is not associated with specific serogroups of *E. coli*. A strain of ETEC may produce either LT or ST, or both. Many tests are available for demonstration of the LT or ST produced by ETEC. These tests, therefore, are used for detection and identification of *E. coli* isolates from stool as ETEC (Table 31-7).

- The presence of LT in isolates of *E. coli* can be demonstrated by:
  - Showing fluid accumulation in rabbit ileal loop method.
  - Showing vascular permeability factor of the toxin in adult rabbit skin method.
  - Tissue culture tests (rounding of Y1 mouse adrenal cells and elongation of Chinese hamster ovary cells [CHO] cells due to intracellular increase of cAMP concentration).
  - Serological tests (agar gel diffusion, reverse passive hemagglutination, and enzyme-linked immunosorbent assay).
  - Genetic probes. These are available for detection of LT in *E. coli* isolates from stool cultures, or directly in feces.
- The presence of ST in isolates of *E. coli* can be demonstrated by:
  - Infant mouse test—it is still widely employed for detection of ST in isolates of *E. coli*.
  - Genetic probes—for detection of ST in *E. coli* isolates from stool cultures, or directly in feces.

**Identification of EIEC:** Many of the EIEC strains are atypical *E. coli* strains. They are nonmotile and do not ferment lactose, or ferment it late with production of acid, but without producing any gas. They also do not decarboxylate lysine. EIEC are identified by:

**Sereny test:** The test is carried out in guinea pigs by instillation of isolated EIEC into the conjunctival sac of guinea pigs. The animal is examined after 72 hours for mucopurulent conjunctivitis and severe keratitis.

**Cell culture test:** The toxin can be demonstrated in HeLa or HEP-2 cells. The bacterial suspension is added to a monolayer

TABLE 31-7

Methods of detection of LT and ST of *Escherichia coli*

Type of toxin of <i>Escherichia coli</i>	<i>In vivo</i> tests	<i>In vitro</i> tests
<b>Heat labile toxin (LT)</b>	Injection into closed ligated rabbit ileal loops produces outpouring of fluid and ballooning of the loops Increases skin capillary permeability in adult rabbit skin (vascular permeability factor)	Causes rounding and steroid production from Y1 mouse adrenal cells Causes elongation of Chinese Hamster ovary cells ELISA DNA probes
<b>Heat stable toxin (ST)</b>	Induces fluid accumulation in the intestines of infant mice within 4 hours of intragastric administration. Induces fluid accumulation in the intestinal loops of neonates but not weaned piglets	ST – ELISA DNA probes

of the cells. The cells are then examined for the presence of intracellular *E. coli* because EIEC, if present, penetrate these cells and replicate inside the cells.

**VMA enzyme-linked immunosorbent assay:** This is a serological test used to detect the plasmid, which codes for outer membrane antigens called the VMA, in stool isolates of EIEC.

**Identification of EHEC:** *E. coli* O157:H7 is the most common serotype associated with the clinical disease caused by EHEC strains. The strain typically does not ferment sorbitol; hence sorbitol MacConkey medium is frequently used for isolation of the strain from stool by culture. Identification of EHEC strains is by:

- Demonstrating cytotoxic effects of EHEC on Vero or HeLa cells.
- Using DNA probes for VT1 and VT2 genes in EHEC directly in feces or in culture isolates.

**Identification of other strains:** EAEC strains are identified by agglutination tests with specific antisera. Most of them are not typed by O antisera, but by specific H antisera.

## Treatment

*E. coli* isolated from community-acquired infections are usually sensitive to commonly used antibiotics except penicillins. Hospital-acquired *E. coli* isolates, however, show multidrug resistance. Majority of *E. coli* infections are best treated based on antibiotics susceptibility testing results. UTI and neonatal sepsis are treated with appropriate antibiotic therapy. Treatment of bacterial gastroenteritis is primarily supportive. Antibiotic therapy is rarely indicated and is deferred until culture results are available. Presumptive therapy is not given due to the potential risks associated with antibiotic treatment for diarrhea caused by *E. coli* O157:H7. Third-generation cephalosporins, such as ceftriaxone, are recommended for meningitis and pneumonia caused by *E. coli*.

## Prevention and Control

Availability of safe drinking water, proper food hygiene, and sanitary disposal of excreta are the most cost-effective strategies for reducing the incidence of enteric infections caused by *E. coli*. Cooking ground beef thoroughly is the most effective way to prevent hemorrhagic colitis caused by *E. coli* O157:H7.

## Edwardsiella

The genus *Edwardsiella* differs from the genus *Escherichia* by its ability to produce hydrogen sulfide. The genus *Edwardsiella* includes *Edwardsiella tarda*, the only pathogenic species for humans. *E. tarda* inhabits the intestines of snakes and other cold-blooded animals. The name *tarda* refers to slow or weak fermentation of sugars by the bacteria. *E. tarda* is a Gram-negative, noncapsulated, motile bacillus with weak fermentative powers.

It ferments only glucose and maltose with production of acid and some gas. It is indole, H<sub>2</sub>S, and citrate positive, and it decarboxylates lysine and ornithine.

*E. tarda* is an occasional human pathogen isolated from wounds, blood, and CSF in cases of fatal meningitis. The bacteria have also been isolated from stool of normal healthy people and that of patients with diarrhea. Nevertheless, the pathogenic role of the bacteria in causation of diarrhea is yet to be established.

## Citrobacter

*Citrobacter* is a normal inhabitant of the intestine of humans. The genus *Citrobacter* consists of three species, namely, *Citrobacter freundii*, *Citrobacter amalonaticus*, and *Citrobacter koseri* (formerly *C. diversus*). They grow well on nutrient agar and other ordinary media producing smooth and convex colonies. The colonies are not pigmented. On MacConkey and DCA media, they produce pale colonies. *Citrobacter* spp. are motile, H<sub>2</sub>S positive, MR positive, citrate positive, and indole variable. They do not decarboxylate lysine, but most strains decarboxylate ornithine. They ferment lactose late or do not ferment at all. Differences between three species in their biochemical characteristics are summarized in Table 31-8. They show extensive antigenic sharing with salmonellae, hence may be mistaken for salmonellae. Certain strains possess a Vi antigen, closely related to the antigen of *Salmonella* Typhi and *Salmonella* Paratyphi. *Citrobacter* spp. may cause infections of the urinary tract, gall bladder, and middle ear and meninges. *C. koseri* may occasionally cause meningitis in neonates.

## Klebsiella

The genus *Klebsiella* belongs to the tribe Klebsielleae in the family Enterobacteriaceae. The bacteria are named after Edwin Klebs, who demonstrated the bacteria for the first time. Members of the genus *Klebsiella* are Gram-negative, rod-shaped, nonmotile bacteria, with a prominent polysaccharide capsule. The classification of *Klebsiella* has undergone various modifications. Earlier, the genus *Klebsiella*, based on biochemical reactions, was classified into three main species. Currently,

TABLE 31-8

Important properties used for differentiation of *Citrobacter* species

Properties	<i>Citrobacter freundii</i>	<i>Citrobacter koseri</i>	<i>Citrobacter amalonaticus</i>
Indole	—	+	+
H <sub>2</sub> S production	+	—	—
Acid from salicin	—	+	+
Acid from malonate	—	+	—
Acid from adonitol	—	+	—

based on DNA homology, they have been divided into seven species, namely: (a) *Klebsiella pneumoniae*, (b) *Klebsiella ozaenae*, (c) *Klebsiella rhinoscleromatis*, (d) *Klebsiella oxytoca*, (e) *Klebsiella planticola*, (f) *Klebsiella terrigena*, and (g) *Klebsiella ornithinolytica*.

In recent years, Klebsiellae organisms are emerging as important agents of nosocomial infections. *K. pneumoniae* is the most important species of the group to cause infections in humans. *K. oxytoca* and *K. rhinoscleromatis* have also been occasionally associated with human infections.

## ***Klebsiella pneumoniae***

*K. pneumoniae*, also known as *Friedlander's bacillus*, was first isolated by Friedlander in 1883, from fatal cases of pneumonia. *K. pneumoniae* are Gram-negative, short and straight rods measuring about  $1-2 \times 0.5-0.8 \mu\text{m}$  in size. They are nonmotile and nonsporing. They are arranged singly or in pairs. Freshly isolated strains show a well-defined polysaccharide capsule. The capsule is often prominent and can be made out even in Gram-stained smears as haloes around the bacilli, and is produced well when grown in media enriched with carbohydrates. The capsule can also be demonstrated by India ink preparation and Quellung's reaction. Accumulation of extracellular polysaccharides as a loose slime gives mucoid appearance to *Klebsiella* colonies. They are fimbriated, and most strains possess one or more of three types of fimbriae: types 1, 3, and 6. They are nonmotile and nonsporing. They are lactose-fermenting, urease-positive, and indole-negative organisms; however, some strains of *K. pneumoniae* and *K. oxytoca* are exceptions. They do not produce hydrogen sulphide, and they are both VP and MR tests positive. They grow well on ordinary media, such as nutrient agar and MacConkey agar at  $37^\circ\text{C}$ , forming large, dome-shaped, mucoid colonies. They produce lactose-fermenting red colonies on MacConkey agar. *Klebsiella* possesses 77 capsular polysaccharides (K antigens) and 8 somatic LPSs (O antigens). The members of Klebsiellae have been classified into over 80 serotypes based on the capsular K antigens and somatic O antigens. All serotypes are of the same virulence. Klebsiellae consists of invasive bacteria. They possess many virulence factors:

1. **Capsule** is the main virulence factor. The capsule prevents the bacteria from phagocytosis by polymorphonuclear granulocytes. The capsule also prevents bacterial death caused by bactericidal serum factors by inhibiting the activation or uptake of complement components, especially C3b.
2. **Multiple adhesins** are other virulence factors. These adhesins help the bacteria to adhere to host cells, which is crucial to initiate the disease process.
3. **LPS** is another factor that prevents membrane damage and death of bacteria. The LPS of the bacteria activates the complement, which causes selective deposition of C3b onto LPS molecules at sites away from cell membrane of the bacteria. This inhibits the formation of the membrane attack complex (C5b-C9), which is responsible for cell death of the bacteria.

Klebsiellae organisms cause a variety of clinical syndromes in humans. These are (a) community-acquired pneumonia, (b) UTI, (c) nosocomial infection, and (d) bacteremia and sepsis.

1. **Community-acquired pneumonia** is a very serious condition with a rapid onset and often fatal outcome despite early and appropriate antimicrobial treatment. Lobar pneumonia characteristically is associated with massive mucoid inflammatory exudate of lobar or lobular distribution, involving one or more lobes of the lung. Necrosis and abscess formation are more frequent than in pneumococcal pneumonia. *K. pneumoniae* serotypes 1, 2, and 3 are usually associated with the condition. Patients present with an acute onset of high fever and chills, flu-like symptoms, and productive cough with abundant, thick, tenacious, and blood-tinged sputum. Blood culture is positive in about 25% of the cases.
2. **UTI** caused by *K. pneumoniae* is a common problem in patients with indwelling catheters. UTIs caused by *K. pneumoniae* cannot be distinguished clinically from those caused by *E. coli* and other common bacteria.
3. *K. pneumoniae* are emerging as important agents of **nosocomial infections** in hospitals. The presence of invasive devices, contamination of respiratory support equipment, use of urinary catheters, and use of antibiotics greatly increases the likelihood of nosocomial infections in hospitalized patients. In addition, poor health status and treatment in an intensive care unit or nursing home are other factors. UTI, pneumonia, bacteremia, wound infection, cholecystitis, and catheter-associated bacteriuria are the common nosocomial infections associated with *K. pneumoniae*. Other rare nosocomial infections include cholangitis, meningitis, endocarditis, and bacterial endophthalmitis.
4. *Klebsiella* **bacteremia and sepsis** produce clinical manifestations similar to those caused by *E. coli* and other Gram-negative enteric organisms. In neonatal units, outbreaks of infection caused by extended-spectrum beta-lactamase (ESBL)-producing *Klebsiella* strains present a more serious problem and may be associated with high mortality.

ESBL strains of *Klebsiella* show the following features: (a) these are highly virulent, (b) they possess capsular type K55 antigen, and (c) they have an extraordinary ability to spread.

Diagnosis of *K. pneumoniae* infection is made by isolation of bacteria from clinical specimens obtained from possible sites (e.g., wounds, peripheral or central intravenous access sites, urinary catheters, respiratory support equipment) and by culture (Fig. 31-4, Color Photo 32). *Klebsiella* organisms may also be isolated from urine, blood, pleural fluid, and wounds. Serological tests are not useful for the detection of infection with *K. pneumoniae*.

The choice of a specific antimicrobial agent depends on antibiotics susceptibility patterns of isolated strains. A wide range of beta-lactams, aminoglycosides, quinolones, and other antibiotics are useful for treatment of *Klebsiella* infections. Cephalosporins are widely used as monotherapy and

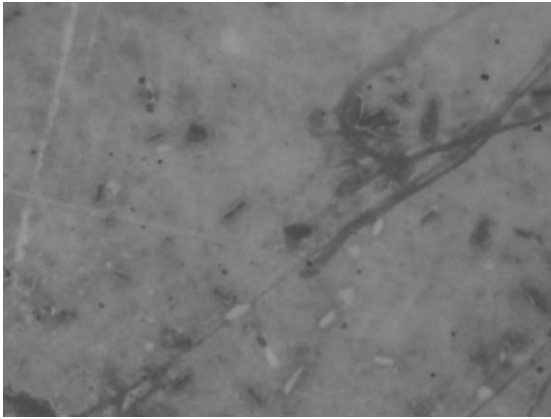

**FIG. 31-4.** Gram-stained smear showing capsulated *Klebsiella pneumoniae* ( $\times 1000$ ).

in combination with aminoglycosides. Cephalosporins are not used for ESBL strains of *K. pneumoniae*. The carbapenems, especially imipenem, are effective against such ESBL strains. Aztreonam and quinolones are recommended for patients allergic to penicillin.

Hand washing holds the key to prevent transmission from patient to patient via medical personnel. Contact isolation is useful for patients colonized or infected with highly antibiotic-resistant *Klebsiella* strains, such as ESBL-*K. pneumoniae*.

## Key Points

Susceptibility of isolated ESBL-producing *K. pneumoniae* is determined by various methods:

- Disk diffusion test is performed using cefotaxime and ceftazidime disks and those containing a combination of clavulanic acid with these antibiotics. These discs are placed on Mueller–Hinton agar. A 5 mm or greater increase in the size of the zone diameter for either cefotaxime or ceftazidime tested in combination with clavulanic acid versus the zone for either antibiotic tested alone indicates a positive test.
- E-test is another method performed to evaluate third-generation cephalosporins with and without a beta-lactamase inhibitor.

## *Klebsiella rhinoscleromatis*

Rhinoscleroma caused by *K. rhinoscleromatis* is a chronic inflammatory disease involving the nasopharynx. Infection with *K. rhinoscleromatis* has a worldwide distribution and is usually observed in areas of southeastern Europe, Central America, and India. Patients present with a purulent nasal discharge with formation of crusts and nodules that may lead to respiratory obstruction. The bacilli are seen intracellularly in lesions, which can be isolated and identified by biochemical reactions. Diagnosis is by positive blood culture supplemented with histology. Rifampin has been used for treatment of rhinoscleroma.

## *Klebsiella ozaenae*

Ozena, caused by *K. ozaenae*, is a chronic atrophic rhinitis characterized by necrosis of nasal mucosa and mucopurulent nasal discharge. It often occurs in elderly persons. Nasal congestion and a constant nasal bad smell are the common symptoms. However, unlike rhinoscleroma, nasal congestion is not a prominent feature. Patients may also complain of headache and symptoms attributable to chronic sinusitis. Identification of *K. ozaenae* is difficult due to wide variations in the biochemical reactions of isolated strains. Trimethoprim and sulfamethoxazole are used for treatment of ozena.

## *Klebsiella oxytoca*

*K. oxytoca* may be rarely isolated from clinical specimens. It is being increasingly isolated from patients with neonatal septicemia. The bacteria have also been associated with neonatal bacteremia, especially among premature infants and in neonatal intensive care units. The biochemical reactions of different *Klebsiella* species are summarized in Table 31-9.

## Enterobacter

The genus *Enterobacter* includes 12 species, of which *Enterobacter cloacae* and *Enterobacter aerogenes*, followed by *Enterobacter sakazakii* are the most frequently isolated species causing human infections. Other species rarely associated with human infections include *Enterobacter asburiae*, *Enterobacter gergoviae*, *Enterobacter taylorae*, and *Enterobacter hormaechei*. *E. cloacae* and *E. aerogenes* are two most important *Enterobacter* species responsible for a variety of nosocomial infections. Differences between *E. cloacae* and *E. aerogenes* are summarized in Table 31-10.

TABLE 31-9

Important properties used for differentiation of *Klebsiella* species

Properties	<i>Klebsiella pneumoniae</i>	<i>Klebsiella ozaenae</i>	<i>Klebsiella rhinoscleromatis</i>	<i>Klebsiella oxytoca</i>
Indole	—	—	—	+
Urease	+	—	—	+
Citrate	+	V	—	+
ONPG	+	+	—	+
Malonate	+	—	+	+
Lysine decarboxylase	+	V (40%)	—	+
Ornithine decarboxylase	—	—	—	—
MR	—	+	+	V (20%)
VP	+	—	—	+

TABLE 31-10

Differentiation of *Enterobacter* species

Properties	<i>Enterobacter aerogenes</i>	<i>Enterobacter cloacae</i>
Gas from glycerol	+	–
Aesculin hydrolysis	+	–
Arginine dihydrolase	+	–
Lysine decarboxylase	+	–

*Enterobacter* are Gram-negative bacilli, which belong to the tribe Klebsielleae, and are aerobic and facultatively anaerobic. On sheep blood agar, *Enterobacter* produces large, gray, and dry or mucoid colonies; on MacConkey agar, lactose-fermenting pink colonies. The bacteria ferment glucose with production of acid. They differ from *Klebsiella* by being motile, urease-negative, and ornithine decarboxylase-positive. Endotoxin of the bacteria is known to play a major role in the pathogenesis of sepsis and its complications.

*Enterobacter* species rarely cause disease in otherwise healthy people. These are opportunistic pathogens. The patients who stay in hospital, especially in the ICU, for prolonged periods are at high risk to acquire *Enterobacter* infections. The patients treated earlier with antimicrobial agents and those with serious underlying conditions (e.g., diabetes, malignancies, burns, mechanical ventilation), with foreign devices (e.g., such as intravenous catheters), and with immunosuppression are also at increased risk of infection by the bacteria.

In these patients, they cause frequent and severe nosocomial infections, such as UTIs, lower respiratory tract infections, skin and soft tissue infections, bacteremia, endocarditis, intra-abdominal infections, septic arthritis, and osteomyelitis. These infections are associated with:

- prolonged hospitalization,
- use of a variety of different surgical and nonsurgical procedures, and
- use of recent and expensive antimicrobial agents.

These bacteria cause significant morbidity and mortality, and infection management is complicated by multiple antibiotic resistances shown by the bacteria. These bacteria possess inducible beta-lactamases, which are not detectable *in vitro*, but are responsible for resistance during treatment. The sources of infection may be endogenous or exogenous.

- The endogenous *Enterobacter* infections originate from the skin, gastrointestinal tract, or urinary tract colonized by the bacteria.
- The hands of medical personnel, intravenous solutions, endoscopes, blood products, devices for monitoring intra-arterial pressure, and stethoscopes are the frequently reported sources for exogenous infections caused by *Enterobacter*.

Diagnosis is made by repeated culture from appropriate clinical specimens. Blood culture is useful in isolation of the bacteria from bacteremia patients.

Carbapenems, fourth-generation cephalosporins, aminoglycosides, new quinolones, and trimethoprim-sulfamethoxazole (TMP-SMX) are the most frequently used antibiotics against *Enterobacter* infections.

Third-generation cephalosporins frequently show good *in vitro* activity against these organisms, but are associated with an increased risk of developing full resistance during therapy.

Carbapenems show the best activity against *E. cloacae*, *E. aerogenes*, and other species.

First-generation and second-generation cephalosporins are not used against infections caused by *Enterobacter*.

### Hafnia

*Hafnia alvei* is the only species of the genus *Hafnia*. It is found in human and animal feces, sewage, soil, and water. *H. alvei* is motile. It does not ferment lactose, raffinose, sucrose, adonitol, dulcitol, and inositol. It is indole and MR negative, and VP and citrate positive. Biochemical reactions are better read on incubation at 22°C than at 37°C. The bacteria have been isolated from abscesses, wounds, sputum, urine, blood, and from other sites, but often with other bacteria. The pathogenic role of *H. alvei* is yet to be established.

### Serratia

*Serratia* are Gram-negative bacteria classified in the tribe Klebsielleae. *Serratia marcescens* is the only pathogenic species causing human infection. *S. marcescens*—as a causative agent of a bloody discoloration in a cornmeal mush called polenta—was first identified by Bartolomeo Bizio, a pharmacist from Padua, Italy, in 1819. The bacterium was named *Serratia* in honor of an Italian physicist named Serrati, who invented the steamboat. The species name *marcescens* is derived from the Latin word meaning decaying due to fast-deteriorating nature of the bloody pigment produced by the bacteria. Since the 1960s, *S. marcescens* been recognized as an opportunistic pathogen causing infection in humans. Some strains of *S. marcescens* typically produce a nondiffusible pigment called prodigiosin, which varies in color from dark red to pink or magenta, depending on the age of the colonies. *S. marcescens* usually grows on starchy foodstuffs, where the production of pigmented colonies is easily mistaken for drops of blood. *S. marcescens* are pleomorphic with minute coccobacillary and normal bacillary forms.

In the hospital, *Serratia* usually colonizes the respiratory and urinary tracts of adult patients. The bacteria is responsible for nearly 2% of nosocomial infections of the urinary tract, lower respiratory tract, surgical wounds, blood, and skin and soft tissues of these patients. *S. marcescens* has been associated with outbreaks of meningitis, wound infections, and arthritis in pediatric wards, and in the intensive care units. The bacteria also causes endocarditis and osteomyelitis in people addicted to intravenous drugs, such as heroin. Older people, patients



with previous antibiotic treatment and chronic or debilitating diseases are at increased risks for severe infections with *Serratia*.

*S. marcescens* is sensitive to amikacin and quinolones but is resistant to gentamicin and tobramycin. The bacteria are naturally resistant to ampicillin, macrolides, and first-generation cephalosporins. Therefore, treatment of *S. marcescens* is based on the results of antibiotics susceptibility testing.

## Proteus

The genus *Proteus* along with two other genera *Morganella* and *Providencia* belongs to the tribe Proteeae. The name “*Proteus*” (after the Greek god Proteus who could assume any shape) refers to their property of pleomorphism. All the members of the tribe Proteeae with few exceptions are Gram negative, noncapsulated, pleomorphic, and motile bacilli. Most of these bacteria, except for some strains of *Providencia*, produce the enzyme urease which rapidly hydrolyses urea to form ammonia and carbon dioxide. They are MR positive and VP negative, degrade tyrosine, and grow in the presence of KCN. They do not decarboxylate amino acids, such as arginine or lysine or dehydrogenase ornithine. They do not ferment lactose or dulcitol, and do not utilize malonate. The formation of the enzyme phenyl alanine deaminase, which converts phenyl alanine to phenyl pyruvic acid (PPA reaction), is the characteristic feature of the tribe Proteeae by which they are differentiated from other members of the family Enterobacteriaceae. The differentiating features of different genera in the tribe Proteeae are summarized in Table 31-11.

The genus *Proteus* has four species: *Proteus mirabilis*, *Proteus vulgaris*, *Proteus penneri*, and *Proteus myxofaciens*. *P. mirabilis* is the most important species, which causes 90% of *Proteus* infections and is associated with community-acquired urinary tract and wound infection. *P. vulgaris* and *P. penneri* are usually associated with hospital-acquired infections. They are isolated from patients with chronic debilitating diseases and from those who are immunocompromised.

## Properties of the Bacteria

### ► Morphology

*Proteus* shows following features:

- Proteeae organisms are Gram-negative and noncapsulated coccobacilli measuring  $1-3 \times 0.6 \mu\text{m}$  in size.
- They are arranged as single, in pairs, or in short chains.
- Many of them form long, curved, and filamentous forms in young cultures.
- Most of them, with few exceptions, are motile due to the presence of peritrichous flagella.
- They are fimbriated.

### ► Culture

Proteeae organisms are aerobic bacteria, which grow well on ordinary media, such as nutrient agar. *Proteus* colonies on the medium emit a characteristic putrefactive (“fishy” or “seminal”) odor.

**Swarming:** *P. mirabilis* and *P. vulgaris* typically spread or swarm on surface of the medium. They spread on the surface of the plate in successive waves to form a thin filmy layer in concentric circles. This is known as swarming (Fig. 31-5, Color Photo 33). The exact mechanism responsible for swarming shown by *Proteus* species is not known. Swarming, shown by *Proteus*, is a problem when mixed growth on a solid medium is obtained in which *Proteus* bacilli are present with other bacteria. Hence, several methods are available to inhibit swarming; these include the use of increased concentration of agar in the medium from 1–2% to 6%, and the use of chloral hydrate (1:500), sodium azide (1:500), alcohol (56%), sulfonamide, surface active agents, or boric acid (1:1000). Swarming does not occur on MacConkey medium, on which *Proteus* produces colorless non-lactose-fermenting colonies. It is because bile salts present in the MacConkey medium inhibit the swarming.

### ► Biochemical properties

*Proteus* shows following reactions:

- *Proteus* species ferment glucose with production of acid only.
- They are urease and PPA positive.

TABLE 31-11

Differentiation of genera of the Tribe Proteeae

Biochemical properties	<i>Proteus mirabilis</i>	<i>Proteus vulgaris</i>	<i>Morganella morganii</i>	<i>Providencia stuartii</i>	<i>Providencia rettgeri</i>
Indole	–	+	+	+	+
H <sub>2</sub> S	+	+	– (20%)	–	–
Citrate	+(65%)	V (15%)	–	+	+
Fermentation of sucrose	–	+	–	V (50%)	–
Fermentation of maltose	–	+	–	–	–
Fermentation of mannitol	–	–	–	–	+
Fermentation of trehalose	+	V (30%)	–	+	–
Ornithine decarboxylase	+	–	+	–	–

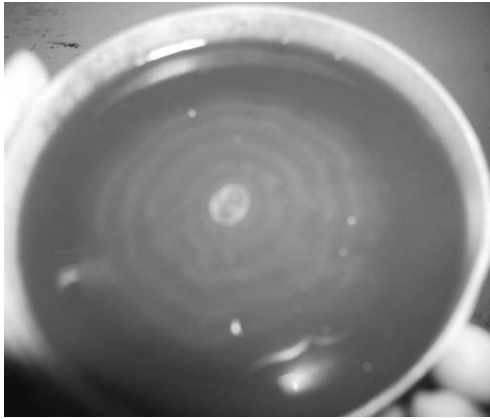

FIG. 31-5. *Proteus* spp. showing swarming on the blood agar.

- They do not ferment lactose, mannitol, mannose, inositol, adonitol, dulcitol, sorbitol, raffinose, and arabinose.
- They reduce nitrate to nitrite but do not utilize malonate.
- They do not decarboxylate amino acids, such as lysine or arginine.
- *Proteus* species show variable reactions in the production of hydrogen sulfide and indole. *P. mirabilis* is indole negative, while *P. vulgaris* is indole positive.

Biochemical characteristics of *Proteus* species are summarized in Table 31-11.

### Cell Wall Components and Antigenic Properties

Motile *Proteus* strains possess somatic O and flagellar H antigens. Somatic O antigens are heat-stable proteins, which are resistant to heating at 100 °C. They are also resistant to treatment with ethanol and dilute hydrochloric acid. Thirty two different O antigens are found in *P. mirabilis*, 22 in *P. vulgaris*, and five in *P. penneri* and *P. myxofaciens*.

- The O antigen contains both alkali-labile and alkali-stable fractions. The alkali-stable component is polysaccharide in nature and shows cross-reactivity with certain rickettsial antigens. The sharing of antigens with rickettsial antigens was first observed by Weil and Felix. They observed that certain nonmotile strains of *P. vulgaris* called the “X strains” were agglutinated by sera from typhus fever patients. This heterophilic agglutination by certain *Proteus* strains formed the basis of the Weil–Felix reaction for the diagnosis of some rickettsial infections. Three nonmotile *Proteus* strains OX19 (*P. vulgaris* serotype O1), OX2 (*P. vulgaris* serotype O2), and OXK (*P. mirabilis*) are used in the Weil–Felix agglutination test.
- Flagellar antigens are heat-labile proteins sensitive to ethanol and to dilute hydrochloric acid.

On the basis of their O antigens, *P. mirabilis* and *P. vulgaris* have been classified into 54 O groups. These O groups are further subdivided into a large number of O types depending on their flagellar or H antigens.

### Pathogenesis and Immunity

*Proteus* organisms are invasive bacteria.

#### ► Virulence factors

*Proteus* possesses following virulence factors:

**Pili:** Fimbriae or pili are the important virulence factors that facilitate adherence of *P. mirabilis* bacteria to host tissue sites, such as the urinary tract epithelium.

**LPS or endotoxin:** This causes a series of host inflammatory responses and is responsible for Gram-negative endotoxin-induced sepsis caused by *Proteus* species.

**Urease production:** The ability of *Proteus* organisms to produce urease is an important factor in pathogenesis of UTI caused by *Proteus* species.

Hydrolysis of urea to ammonia makes the urine alkaline, which provides a suitable environment for *Proteus* to survive. Subsequently, alkalization of urine leads to precipitation of organic and inorganic compounds, which in turn leads to formation of stones in renal calculi. These stones are composed of a combination of magnesium ammonium phosphate (struvite) and calcium carbonate–apatite.

#### ► Pathogenesis of UTI

Pathogenesis of *Proteus* infection depends on the interaction between the bacteria and the host defense mechanisms. Adherence of the bacteria to host tissue mediated by fimbriae is the first step in the disease process. The attachment of *Proteus* species to uroepithelial cells causes secretion of interleukin-6 and interleukin-8. *Proteus* also induces apoptosis and desquamation of epithelial cells. The infection of the urinary tract is facilitated further by production of the enzyme urease and also motility of the bacteria. Urease splits urea into ammonia and carbon dioxide. The ammonia/ammonium buffer pair has a pH of 9.0, leading to excretion of highly alkaline urine, rich in ammonia. The alkalinity of urine contributes to production of renal stones, which is characteristically observed in patients suffering from UTI due to *Proteus* species.

### Clinical Syndromes

Patients with multiple antibiotic treatments, urinary tract obstruction, or infection developing after catheterization or instrumentation frequently become infected with *Proteus* spp. or other bacteria, such as *Enterobacter* spp., *Klebsiella* spp., *Serratia* spp., and *Acinetobacter* spp. *Proteus* species cause (a) urinary tract infections, (b) hospital-acquired infections, and (c) other miscellaneous infections.

#### ► Urinary tract infections

UTIs are the most common clinical manifestation of *Proteus* infections. *Proteus* is responsible for nearly 1–2% of UTIs in healthy women and 5% of hospital-acquired UTIs. It is responsible for 20–45% of UTIs associated with catheterization. Patients with UTI may present with urethritis, cystitis,

prostatitis, or pyelonephritis. Chronic UTI is associated with chronic, recurring stones. Urine sediments show multiple magnesium ammonium phosphate crystals.

### ► Hospital-acquired infections

Hospital-acquired infections are usually transmitted from attending doctors or other healthcare workers and are caused by interruption of the closed sterile system by hospital staff.

### ► Miscellaneous infections

*Proteus* species is an important agent of wound infections. The species also causes infection of the umbilical stump in neonates, which often leads to sepsis neonatorum, bacteremia, and meningitis. *Proteus* spp. also causes nonclostridial anaerobic myonecrosis, a condition which involves subcutaneous tissue, fascia, and muscle. This condition usually occurs in association with other aerobic Gram-negative bacilli (*E. coli*, *Klebsiella* spp., or *Enterobacter* spp.) and anaerobes. *Proteus* organisms like that of *Pseudomonas* can cause Gram-negative endotoxin-induced sepsis, resulting in systemic inflammatory response syndrome, which has a mortality rate of 20–50%.

## Epidemiology

*Proteus* infections are found worldwide. They are opportunistic pathogens, responsible for urinary and hospital-acquired infections. *Proteus* is widely distributed as saprophytes in nature. They are commonly found in sewage, in manure soil, in human and animal feces, and in decomposing animal products. *Proteus* species are most commonly found as part of normal human intestinal flora, along with *E. coli* and *Klebsiella* species. They are also present on the moist areas of the skin. In hospital settings, they most commonly colonize the skin and oral mucosa of patients and hospital personnel. Infection to patients primarily occurs from these reservoirs.

### ► Typing

*Proteus* species can be typed by (a) serotyping, (b) phage typing, (c) bacteriocin (proticin) typing, and (d) Dienes typing. Proticin typing is frequently carried out by using 12 standard proticin-producing strains, and most of the *Proteus* strains are typeable by this method.

## Key Points

### *Dienes typing*

It is used to determine the identity or nonidentity of strains of *Proteus*. This is based on the observations that when two identical strains of *Proteus* are inoculated at two different sites on a solid agar that does not inhibit swarming, then those two strains show swarming, which coalesce together without any demarcation. However, if the strains are not identical, then the swarming strains do not coalesce together, instead are separated from each other with a clearly visible furrow between swarming of the two. This is known as Dienes phenomenon.

## Laboratory Diagnosis

Urine is the specimen of choice for diagnosis of UTIs. Urine is collected in the same way as described earlier for UTI caused by *E. coli*. Other specimens are collected depending on the nature of infections. These include pus for wound infections, blood for septicemia, CSF for meningitis, etc. Definitive diagnosis is based on the isolation of *Proteus* spp. from various clinical specimens by culture. Urine culture is carried out in the same way as described earlier for *E. coli* and other Gram-negative bacteria. After incubation overnight at 37°C, pale, nonlactose-fermenting colonies of *Proteus* on the MacConkey agar and those on blood agar are identified by various biochemical tests and agglutination reactions (Table 31-11). Culture of blood, CSF, and other specimens is also carried out depending on the clinical diseases caused by *Proteus*.

## Treatment

The choice of a specific antimicrobial agent depends on antimicrobials susceptibility patterns of isolated strains. *P. mirabilis* is susceptible to nearly all antimicrobials except tetracycline. *P. mirabilis* is sensitive to ampicillin; broad-spectrum penicillins, such as ticarcillin, piperacillin; first-, second-, and third-generation cephalosporins; imipenem; and aztreonam. Resistance to these antibiotics is not a significant problem; only 10–20% of strains develop resistance to ampicillin and first-generation cephalosporins. Development of resistance to extended-spectrum beta-lactams is uncommon.

*P. vulgaris* and *P. penneri* are sensitive to trimethoprim and sulfamethoxazole, quinolones, imipenem, aminoglycosides, and fourth-generation cephalosporins. They are resistant to ampicillin and first-generation cephalosporins. The resistance is mediated by activation of an inducible chromosomal beta-lactamase occurring in up to 30% of these strains.

## Prevention and Control

Hand washing holds the key to prevent transmission from patient to patient via medical personnel. A vaccine derived from purified mannose-resistant/*Proteus*-like (MR/P) fimbriae proteins has been evaluated to prevent infection in experimental mouse models and is still under clinical research. The vaccine is yet to be evaluated in humans.

## *Morganella*

The genus *Morganella* belongs to the tribe Proteeae. The genus *Morganella* has only one species, *Morganella morganii* with two subspecies, *morganii* and *sibonii*. *M. morganii* was classified earlier under the genus *Proteus* as *Proteus morganii*. *M. morganii* are small, Gram-negative, motile bacilli, but unlike *Proteus* species do not produce swarming on the solid media. They are facultatively anaerobic and nonencapsulated. They grow on blood agar or on MacConkey agar. They are oxidase negative and catalase and indole positive. *M. morganii* ferments glucose and mannose

but not lactose. The bacteria decarboxylate ornithine, hydrolyze urease, and reduce nitrates. They do not liquefy gelatin and do not produce hydrogen sulfide. *M. morganii* is commonly found in human and animal feces and rarely causes severe invasive diseases. It is most often found as an opportunistic pathogen in patients who are hospitalized, particularly those on prolonged antibiotic therapy. *M. morganii* causes UTIs, which are often associated with an alkaline urine pH. The bacteria have also been occasionally reported to cause sepsis, pneumonia, wound infections, pericarditis, chorioamnionitis, endophthalmitis, empyema, spontaneous bacterial peritonitis, and CNS infections. Nosocomial *M. morganii* strains are usually susceptible to cefepime, imipenem, meropenem, piperacillin, aminoglycosides, and fluoroquinolones. These have also shown resistance to ceftazidime and other third-generation cephalosporins. ESBL-producing strains of *M. morganii* have been reported recently.

## Providencia

The genus *Providencia* consists of five species: *Providencia stuartii*, *Providencia rettgeri*, *Providencia alcalifaciens*, *Providencia rustigianii*, and *Providencia heimbachae*. *Providencia* spp. are Gram-negative, motile bacilli but do not show swarming on solid media. They produce a fruity smell and on DCA form yellow to orange colonies. All the species typically deaminate phenylalanine; only *P. rettgeri* hydrolyses urea consistently. Other biochemical properties of *Providencia* are summarized in Table 31-11. *Providencia* species have been isolated from urine, stool, and blood, as well as from the throat, perineum, axilla, and wounds from humans.

*P. stuartii* is the most common species causing infection in humans. *P. stuartii* and, to a lesser extent, *P. rettgeri* are commonly found in patients with long-term indwelling urinary catheters. Older people are at higher risk of infection by *P. stuartii* or *P. rettgeri*, because these infections are associated with the use of

urinary catheters, and the use of such catheters is much more common in the older people. *P. stuartii* constitutes nearly 60% of all bacterial pathogens isolated from urine of these patients. *P. stuartii* possesses an adhesin, mannose-resistant/*Klebsiella*-like (MR/K) hemagglutinin protein, which allows it to adhere to the urinary catheter. From urine, *P. stuartii* may invade to blood, causing infection of the blood stream, which is common in elderly patients and in immunocompromised patients.

*P. alcalifaciens*, *P. rettgeri*, and *P. stuartii* also may cause invasive diarrhea. These species are emerging as important causes of traveler's diarrhea in adults.

Diagnosis of UTI and diarrhea is made by routine urine and feces culture. Blood culture is useful for diagnosis of suspected blood stream infections. Antibiotics susceptibility testing is useful for treatment with suitable antibiotics, because many *Providencia* species show resistance to multiple antibiotics.

*P. stuartii* is the most resistant species of all *Providencia* species. It is resistant to tetracyclines, older penicillins, cephalosporins, fluoroquinolones, aminoglycosides, and TMP-SMX. It is susceptible to late-generation cephalosporins, aztreonam, and carbapenems.

*P. alcalifaciens* and *P. rustigianii* are usually susceptible to antibiotics. They usually are susceptible to fluoroquinolones, aminoglycosides, late-generation cephalosporins, aztreonam, carbapenems and TMP-SMX. They are resistant to tetracyclines, older penicillins, and cephalosporins.

## Erwinia

*Erwinia* organisms are usually found in soils and they cause infection in plants. *Erwinia herbicola* is the only species that has occasionally been isolated from respiratory and urinary infections in chronic debilitated patients and in hospitalized patients.

### CASE STUDY

A 19-year-old female medical student visited medicine OPD complaining of a burning sensation when passing urine and increased frequency of passing urine. The consultant advised for a culture of urine before prescribing any antibiotics.

- What is the infection?
- What is the best urine specimen to be collected for culture?
- What is significant bacteriuria?
- List the common agents causing this condition.

# Salmonella

## Introduction

Salmonellae are ubiquitous human and animal pathogens. They colonize virtually all animals including poultry, birds, livestock, reptiles, rodents, domesticated animals, and humans.

*Salmonella* infections in humans typically produce one of three clinical syndromes, such as gastroenteritis, enteric fever, or focal disease. In addition, *Salmonella* infection in animals causes substantial losses of livestock.

## Salmonella

*Salmonella* spp. include Gram-negative, flagellated, and facultative anaerobic bacilli characterized by the presence of O, H, and Vi antigens. The taxonomic classification of the genus *Salmonella* is complex and problematic:

- Based on DNA homology and host range, the genus *Salmonella* is classified into two species: *Salmonella* Enterica and *Salmonella* Bongori. *S. Enterica* is further subdivided into six subspecies I, II, IIa, IIIb, IV, and VI.
- Most of the salmonellae that are pathogenic to human beings belong to the subgroup I of *S. Enterica* subsp. *enterica*. This includes the typhoid and paratyphoid bacilli and most other serotypes responsible for diseases in mammals.
- Additionally, each of the *Salmonella* isolates is serotyped according to the presence of particular somatic O, flagellar H, and surface Vi antigens. Presently more than 2400 serotypes are described.
- The *salmonella* serotype is unique in the sense that each *Salmonella* serotype is considered as a species.

Salmonellae serotypes are named as, for example, *S. Enterica* subsp. *enterica* serotype Enteritidis. However, for the sake of convenience, it is abbreviated as *S. Enteritidis* (this chapter follows the same system) or just Enteritidis for use in clinical situations. In addition, serotypes are not mentioned in italic but in Roman. Human infections caused by *Salmonella* spp. are summarized in Table 32-1.

## Properties of the Bacteria

### ► Morphology

Salmonellae are Gram-negative bacilli measuring 1–3  $\mu\text{m}$  in size. They are motile with the presence of peritrichous flagella (*Salmonella* Gallinarum and *Salmonella* Pullorum are exceptions,

TABLE 32-1

### Human infections caused by *Salmonella* spp.

Bacteria	Diseases
<i>Salmonella</i> Typhi	Typhoid fever, <i>Salmonella</i> bacteremia
<i>Salmonella</i> Paratyphi A, B, and C	Paratyphoid fever, <i>Salmonella</i> bacteremia
<i>Salmonella</i> Cholerasuis	<i>Salmonella</i> bacteremia
<i>Salmonella</i> Typhimurium	<i>Salmonella</i> gastroenteritis
<i>Salmonella</i> Enteritidis	<i>Salmonella</i> gastroenteritis
<i>Salmonella</i> Hadar	<i>Salmonella</i> gastroenteritis
<i>Salmonella</i> Heidelberg	<i>Salmonella</i> gastroenteritis
<i>Salmonella</i> Agona	<i>Salmonella</i> gastroenteritis
<i>Salmonella</i> Virchow	<i>Salmonella</i> gastroenteritis
<i>Salmonella</i> Seftenberg	<i>Salmonella</i> gastroenteritis
<i>Salmonella</i> Indiana	<i>Salmonella</i> gastroenteritis
<i>Salmonella</i> Newport	<i>Salmonella</i> gastroenteritis
<i>Salmonella</i> Anatum	<i>Salmonella</i> gastroenteritis

which are nonmotile). They do not form spores and capsules. Some strains of salmonellae may produce fimbriae, but most strains of *Salmonella* Paratyphi A and few strains of *Salmonella* Paratyphi B, *Salmonella* Typhi, and *Salmonella* Typhimurium are nonfimbriated.

### ► Culture

They are aerobic and facultatively anaerobic; they grow at an optimum temperature of 37°C in a pH of 6–8 on a variety of nonselective (Mueller–Hinton agar) and selective (Wilson and Blair’s bismuth sulfite medium) media.

1. **Nonselective solid media:** On *nutrient agar* and *blood agar*, *Salmonella* spp. produce gray white moist colonies with smooth convex surface after 18–24 hours of incubation. Rough strains produce opaque and granular colonies with irregular surface. Some strains of *S. Paratyphi* B produce large mucoid colonies due to the production of loose polysaccharide slime. On *MacConkey agar*, they produce pale colorless colonies because they do not ferment lactose. *S. Typhi* do not grow on this medium. The colonies on *deoxycholate citrate agar* are similar to those produced on MacConkey agar. Sometimes after incubation of 48 hours or more, they produce colonies with a black center.
2. **Selective solid media:** *Wilson and Blair’s bismuth sulfite agar* is the medium of choice for *Salmonella* spp., especially

*S. Typhi*. The growth of *Shigella* spp., *Proteus* spp., and coliforms is inhibited on this medium. On this medium, salmonellae produce jet black colonies surrounded by a metallic sheen due to production of hydrogen sulphide. *S. Paratyphi A* and other species, which do not produce  $H_2S$ , form green colonies. **XLD (xylose, lysine deoxycholate agar)** is another selective medium used for isolation of *Salmonella* spp. On this medium, *Salmonella* spp. produce pink colonies with black centers as a result of  $H_2S$  production.  $H_2S$ -negative *Salmonella* serotypes produce red colonies without black centers.

■ **Liquid media:** Selenite F and tetrathionate broth are commonly used enrichment media. **Selenite F broth** is frequently used for enrichment of *Salmonella* spp. from clinical specimens. However, sometimes this medium inhibits growth of some salmonellae, such as *S. Paratyphi B* and *Salmonella Choleraesuis*. **Tetrathionate broth**, although is used for salmonellae but at times the broth allows the growth of *Shigella* spp. and also that of *Proteus* spp. Tetrathionate broth with brilliant green, although inhibits the growth of *Proteus* spp., sometimes is inhibitory to *Salmonella* spp.

### ► Biochemical reactions

Salmonellae show following reactions:

1. Salmonellae ferment glucose, mannitol, and maltose, forming acid and gas. *S. Typhi* is an exception, which does not ferment the sugars.
2. They do not ferment lactose, sucrose, or salicin.
3. They do not produce indole.
4. Most salmonellae except *S. Paratyphi A*, *S. Choleraesuis*, and some other species produce  $H_2S$ .
5. They do not hydrolyze urea. They are MR positive and VP negative and citrate positive. *S. Typhi* and *S. Paratyphi*,

however, do not grow in Simmon's citrate media as they need tryptophan as the growth factor.

6. Salmonellae decarboxylate lysine, ornithine, and arginine, but not glutamic acids. However, *S. Typhi* do not decarboxylate ornithine and *S. Paratyphi A* does not decarboxylate lysine.
7. Salmonellae are catalase positive and oxidase negative.

The biochemical characteristics are useful for distinguishing different *Salmonella* spp. (Table 32-2).

### ► Other properties

**Susceptibility to physical and chemical agents:** The bacilli are killed at a temperature of  $55^\circ C$  in 1 hour or at  $60^\circ C$  in 15 minutes. They are also killed by 0.2% mercuric chloride or 5% phenol in 5 minutes. Boiling, chlorination of water, and pasteurization of milk kill the bacteria. They survive for weeks in polluted water and soil, and for months in ice. Cultures may be viable for years if prevented from drying.

## Cell Wall Components and Antigenic Structure

### ► Lipopolysaccharide (LPS)

The cell wall of salmonellae like any other Gram-negative bacilli contains a complex lipopolysaccharide (LPS) structure. The LPS is liberated during lysis of the cell and to some extent during culture. The LPS moiety functions as an endotoxin and is an important component of the virulence of the bacteria. The LPS complex consists of three components: (i) an outer O polysaccharide coat, (ii) a middle portion (the R core), and (iii) inner lipid A coat. The LPS of salmonellae is important because of the following reasons:

TABLE 32-2

Biochemical reactions of common *Salmonella* spp.

	<i>Salmonella Typhi</i>	<i>Salmonella Paratyphi A</i>	<i>Salmonella Paratyphi B</i>	<i>Salmonella Paratyphi C</i>
Glucose	A	AG	AG	AG
Mannitol	A	AG	AG	AG
Lactose	—	—	—	—
Sucrose	—	—	—	—
Indole	—	—	—	—
Citrate	—	—	+	+
MR	+	+	+	+
VP	—	—	—	—
$H_2S$	+	—	+	+
Xylose	d	—	AG	AG
D-Tartrate	A	—	—	AG
Mucate	d	—	AG	—

A, acid; AG, acid and gas; d, delayed.

1. The repeating sugar units in the outer O polysaccharide chain are responsible for O-antigen specificity. This also helps to determine virulence of the bacteria. *Salmonella* strains lacking the complete sequence of O sugar repeat units are known as rough strains. They are so called because of rough appearance of the colonies. The rough strains are less virulent or avirulent than the smooth strains, which have a full complement of “O” sugar repeat unit.
2. The endotoxin component of the cell wall is important in the pathogenesis of *Salmonella* infections. Endotoxins cause fever, activate the serum complement kinin and clotting systems, and depresses myocardial functions. The circulatory endotoxin is also responsible in part for development of septic shock that can occur in systemic infection.
3. Antibodies produced against R core (common enterobacterial antigen) are protective against infection caused by wide variety of Gram-negative bacteria due to sharing of common core structure. In some situations, the antibodies against R core mediate the lethal effects of Gram-negative bacteria.

### ► Antigenic properties

*Salmonella* possess three major antigens:

1. H or flagellar antigen
2. O or somatic antigen
3. Surface antigens (Vi antigen, M and N antigen, and F antigens)

**H or flagellar antigen:** This antigen is present on the flagella and is heat and alcohol labile. The antigens are destroyed by boiling or by treatment with alcohols and acid, but they are preserved in 0.2–0.4% formaldehyde. The H antigens of *Salmonella* are genus specific and are not shared by other enterobacteria. The antigens are destroyed by boiling or by treatment with alcohols and acid but they are preserved in 0.2–0.4% formaldehyde. The H antigen is strongly immunogenic and is associated with the formation of antibodies following infection or immunization. H antigen may occur in either or both the forms called phase I and phase II. The organisms tend to change from one phase to another. The complete identification of serotype depends on detection of serological structure in both the phases.

**O or somatic antigen:** O antigens occur on the surface of the outer membranes and are determined by specific sugar sequences on the cell surface. O antigen is an LPS complex and is an integral part of the cell wall. It is heat stable, resistant to boiling up to 2 hours and 30 minutes. It is also alcohol stable, resistant to treatment with 96% ethanol at 37°C for 4 hours and is also resistant to 0.2% formaldehyde. This antigen can be extracted from cell wall by treatment with trichloroacetic acid. Treatment with phenol removes the antigenicity but retains the toxicity of the bacteria. Antigen is less immunogenic than H antigen. Generally, the O antibody titer produced after infection or immunization is lower than that of H antibodies. The O antigen is not a single factor but a mosaic of two or more antigenic factors. *Salmonella* are classified based on the presence of characteristic O antigen on the bacterial surface.

Till now, 67 “O” antigens have been described. On the basis of the somatic antigens, *Salmonella* has been classified into 46 “O” serogroups.

**Surface antigens:** These include (a) Vi antigen, (b) M and N antigens, and (c) F antigens, and are discussed below.

**Vi antigen:** Vi antigen is a surface antigen overlying the “O” antigen. Felix and Pitt, who first described this antigen, believed that it was related to virulence and gave it the name ‘Vi antigen.’ It is analogous to the K antigens of coliforms. The antigen is present only in few serotypes, the most important being *S. Typhi*. This antigen is also present in some strains of *Salmonella* Paratyphi C, *Salmonella* Dublin, and *Citrobacter freundii*. The presence of this antigen on the surface renders these bacteria inagglutinable by their specific O antiserum but agglutinable by Vi antisera. The Vi antigen is heat labile and is destroyed by boiling within 1 hour. Vi antigen is also destroyed by treatment with phenol hydrochloric acid and 0.5 sodium hydroxide, but the antigen remains unaffected by 0.25% formaldehyde or alcohol. The Vi antigen is lost on serial subculture.

### Key Points

#### Vi antigen

- Poorly immunogenic and is associated with production of low titer of antibodies during infection.
- Antibody disappears early in convalescence. Its persistence indicates development of carrier state.
- Complete absence of Vi antibody in a proven case of typhoid fever indicates poor prognosis.
- Phenolized vaccines do not induce Vi antibodies formation in serum, but alcoholized vaccines induce low titer of Vi antibodies.
- Demonstration of the Vi antibody is not useful for the diagnosis of cases of typhoid; hence, Vi antigen is not tested in Widal test.

**M and N antigens:** These antigens are present on the surface of bacteria and are polysaccharide in nature. These antigens prevent agglutination by O antiserum. Boiling for two and half hours destroys these antigens. The presence of M antigen is responsible for mucoid nature of *Salmonella* colonies.

**F antigen:** These antigens are present on the fimbriae. They occur in two phases: one with F antigen and the other without F antigen.

### ► Antigenic variation

*Salmonellae* antigens undergo phenotypic and genotypic variations as follows:

1. OH–O variation
2. V–W variation
3. S–R variation
4. Phase variation
5. Variations in O antigens

**OH–O variation:** Flagellated salmonellae (OH) sometimes give rise to nonflagellated (O) strains. This variation known as

OH-O variation is associated with the loss of flagella. When salmonellae are grown on agar containing phenol (1:800), flagella are not formed. This change is phenotypic and temporary because flagella reappear when the strain is subcultured on media without phenol. The loss of flagella is usually not total but there is only a decrease in the number of flagella and the quantity of the H antigen. Flagellated bacteria are also found in small numbers in such cultures. Subculture in Craigie's tube (Fig. 32-1) is used to obtain a population of flagellated bacteria from such cultures. In Craigie's tube method (Fig. 32-2), a wide tube containing semisolid agar (0.2%) is used. A short, narrow tube, open at both ends, is placed into the agar of the tube in such a way that the upper end of the tube projects well above the agar. The bacterial strain is inoculated into the inner tube, and after 8–16 hours of incubation, subcultures made from top of the agar outside the central tube yield a population of motile cells.

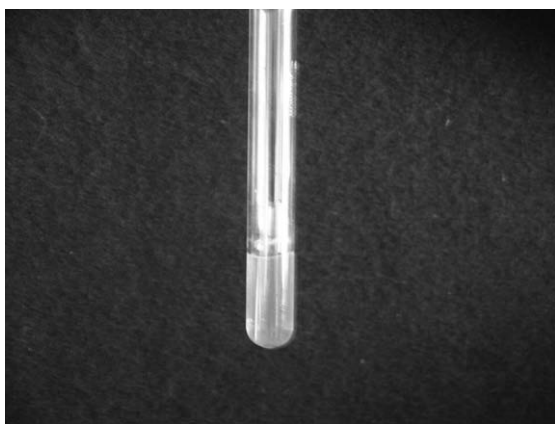

FIG. 32-1. Craigie's tube.

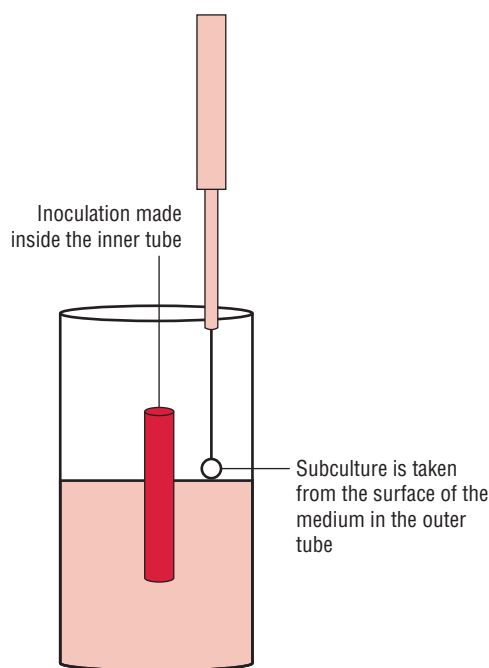

FIG. 32-2. Craigie's tube method.

A U-tube of soft agar instead of Craigie's tube may be used for the purpose, in which inoculation is made into one limb and subculture is taken from the other.

Rarely, salmonellae may lose their flagella by mutation. *S. Typhi* 901-O strain is an example of a stable nonmotile mutant, which is used for the preparation of O-agglutinable bacterial antigen suspensions for use in Widal test and other serological tests.

**V-W variation:** Almost all freshly isolated strains of *S. Typhi* carry a surface layer of Vi antigen that completely masks the O antigen. When fully expressed, such bacilli are agglutinable with Vi antiserum but not with the O antiserum. This is called the V form. After a number of subcultures, the Vi antigen is completely lost. Such cultures are inagglutinable with the Vi antiserum but readily agglutinable with the O antiserum. This is called the W form. With partial loss of the Vi antigen, the bacillus is agglutinable with both Vi and O antisera; such forms are called "VW forms". Vi antigens, however, do not completely mask the O antigen in *S. Paratyphi C* and *S. Dublin*.

**S-R variation:** The smooth-to-rough (S-R) variation occurs due to mutation and is associated with the (i) change in the colony morphology from smooth to rough, (ii) loss of the O antigen, and (iii) loss of virulence. The rough colonies become large, rough, and irregular and are autoagglutinable in saline. These colonies show a defective capacity to synthesize O antigen. Conversion into rough forms occurs rarely in nature but is common in laboratory strains maintained by serial subculture on ordinary media. The smooth S-R variation may be prevented to some extent by maintaining cultures on Dorset's egg media or by lyophilization.

**Phase variation:** The flagellar or H antigens of most salmonellae occur in two alternate phases: phase 1 and phase 2. **Phase 1 antigens** are either specific for a serotype or shared by a few species only, hence known as the "specific" or species phase. A large number of flagellar antigens, more than 80, have been found in this phase. These are designated as small letters of alphabets a-z except j and subsequently z1-z68. The presumptive identification of serotype is based on the identification of the antigen in phase 1. **Phase 2 antigens** are widely shared, hence known as the "nonspecific" or "group" phase. Phase 2 antigens are far fewer and are designated by Arabic numerals from 1 to 12 (1, 2, and 3 ... up to 12).

*Salmonella* strains that occur in both phases are called biphasic, while the strains that occur in one phase only are called monophasic (e.g., *S. Typhi*, *S. Paratyphi A*, etc.).

A culture contains cells with the flagellar or H antigens of both phases but generally one or the other phase predominates so that the culture is agglutinated only by one of the phase antisera. For definite identification of *Salmonella* isolates by serotyping, it is necessary to identify the H antigens of both phases.

Conversion of isolates from one phase to another is achieved by using Craigie's tube method. In this method, a culture in phase 1 is converted to phase 2 by passing it through the Craigie's tube containing specific phase 1 antiserum, and the reverse conversion is achieved by using phase 2 antiserum.



**Variations in O antigen:** Changes in the structural formulae of the O antigen may be brought about by lysogenization with some converting phages, resulting in the alteration of bacterial serotypes. Thus, *Salmonella* Anatum (serotype 3,10:e,h:1,6) is converted by phage 15 into *Salmonella* Newington (serotype 3,15:e,h:1,6) by one phage and the latter into *Salmonella* Minneapolis (serotype 3,15,34:e,h:1,6) by phage 34. Serotypes Newington and Minneapolis are designated as anatum var. 15+ and anatum var. 15+, 34+, respectively.

## Pathogenesis and Immunity

*S. Typhi* is an invasive bacterium. It colonizes the human intestine and, under specific conditions, directly invades the intestinal mucosa or multiplies for several days within the mononuclear phagocytic cells in the liver, spleen, lymph nodes, and Peyer patches of the ileum before invasion. The bacteria subsequently enter the blood stream and cause the disease manifestations.

### ► Virulence factors

Virulence factors of salmonellae are complex (Table 32-3). These are encoded both on the organism's chromosome and on large (34–120 kDa) plasmids.

**Type III secretion systems:** Type III secretion systems (TTSS) consist of nearly 20 proteins, which facilitate secretion of virulence factors of *Salmonella* into host cells. These are encoded by several *Salmonella* pathogenicity islands, such as *Salmonella* pathogenicity-island 1 (SPI-1) and *Salmonella* pathogenicity-island 2 (SPI-2), *phoP/phoQ*. Absence of these pathogenicity islands renders the organism avirulent. TTSS mediate uptake of the bacteria into epithelial cells. SPI-1 mediates nonphagocytic cell invasion and SPI-2 facilitates survival and replication of *Salmonella* within macrophages.

**Endotoxin:** Endotoxin is responsible for many of the systemic manifestations of the disease caused by *Salmonella* spp.

**Fimbriae:** The species-specific fimbriae mediate binding of *Salmonella* to M (microfold) cells present in Peyer patches of

the terminal part of the small intestine. These M cells typically transport foreign antigens, such as bacteria to the underlying macrophages for clearance.

**Acid tolerance response gene:** The acid tolerance response (ATR) gene protects *Salmonella* spp. from stomach acids and the acidic pH of the phagosome, thereby facilitating survival of bacteria in phagosomes by an ATR gene.

**Enzymes:** Catalase and superoxide dismutase are the enzymes that protect the bacteria from intracellular killing in macrophages.

### ► Pathogenesis of enteric fever

The severity of disease in individuals infected with salmonellae is dependent on the virulence factors of the infecting strain as well as on the human host.

**Infective dose:** The infection is acquired by ingestion of food or water contaminated with salmonellae (Fig. 32-3). The infective dose ( $ID_{50}$ ) in human volunteer experiments has been found to be about  $10^3$ – $10^6$  bacilli. Although the infectious dose varies among strains, a large inoculum is necessary to overcome stomach acidity and to compete with normal intestinal flora. Large inocula are also associated with higher rates of illness and shorter incubation periods. However, lower infectious doses may be adequate to cause infection if:

- these organisms are coingested with foods that rapidly transit the stomach (e.g., liquids) or that increase gastric pH (e.g., cheese, milk);
- antacids are used concomitantly; or
- these bacteria are ingested by individuals with defective immune systems.

On reaching the intestine, the salmonellae attach themselves by fimbriae or pili to cells lining the ileal mucosa. The bacteria selectively attach to specialized epithelial cells (M cells) of the Peyer patches. *Salmonella* TTSS mediate the initial invasion of *S. Typhi* into the intestinal mucosa. SPI-1 introduces *Salmonella*-secreted invasion proteins (Sips or Ssps) into the M cells resulting in membrane ruffling. The ruffled membranes surround and swallow salmonellae, leading to intracellular replication in the phagosome with subsequent death of host cells and spread to adjacent epithelial cells and lymphoid tissue. An ATR gene also protects *Salmonella* spp. from stomach acids and the acidic pH of the phagosome. Catalase and superoxide dismutase are other factors that protect the bacteria from intracellular killing. The bacteria are then transported within phagosomes to the lamina propria, where they are released. In the lamina propria, typhoidal strains of salmonellae induce production of macrophages, while nontyphoidal strains induce production of neutrophils (nontyphoidal strains). Subsequently, *S. Typhi* and other virulent *Salmonella* strains invade deeper tissues via lymphatics and capillaries and elicit a major immune response. The organisms travel from the submucosa to the mesenteric lymph nodes, multiply, and then enter the blood stream via the thoracic duct (transient primary bacteremia) to spread to other tissues.

TABLE 32-3

Virulence factors of *Salmonella* spp.

Virulence factors	Biological functions
Endotoxin	Causes many systemic manifestations of salmonellosis
Type III secretion systems	Mediate secretion of virulence factors of <i>Salmonella</i> into host cells
Fimbriae	Mediate binding of <i>Salmonella</i> to M (microfold) cells present in Peyer patches of the terminal part of the small intestine
Acid tolerance response (ATR) gene	Protects <i>Salmonella</i> spp. from stomach acids and the acid pH of the phagosome
Catalase	Protects the bacteria from intracellular killing in macrophages
Superoxide dismutase	Protects the bacteria from intracellular killing in macrophages

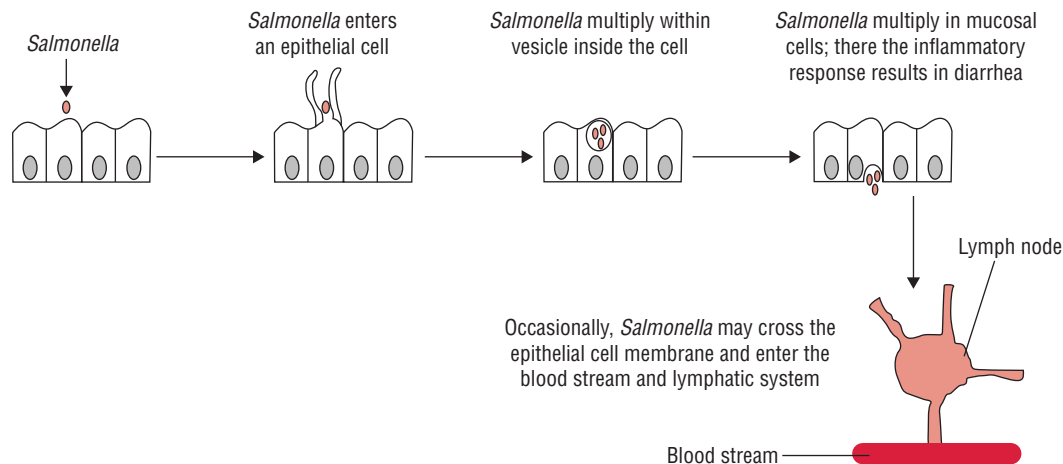

FIG. 32-3. Pathogenesis of *Salmonella* infection.

During this bacteremic phase, the bacteria may invade any organ but most commonly are found in reticuloendothelial tissues of the liver, spleen, bone marrow, gallbladder, and Peyer patches in the terminal ileum. The gallbladder is infected via the liver, and the resultant cholecystitis usually is subclinical. The infected bile renders stool cultures positive. Preexisting gallbladder disease predisposes to chronic biliary infection, leading to long-term fecal carriage.

Invasion of Peyer patches occurs during either the primary intestinal infection or secondary bacteremia, and further spread of bacteria occurs through infected bile. The Peyer patches become hyperplastic with infiltration of chronically inflamed cells, which may lead to necrosis of the superficial layer and ulcer formation, with potential hemorrhage from blood vessel erosion or peritonitis from transmural perforation.

The pathogenesis of the prolonged fever and toxemia of the enteric fever is not well-understood. Pyrogens and mediators produced at the sites of inflammation have been suggested as factors responsible for the prolonged fever.

### ► Host immunity

*Salmonella* spp. are primarily intracellular pathogens, hence cell-mediated immunity (CMI) rather than humoral antibodies play more important role in protection against the disease. CMI develops during the course of the disease and appears to be common in populations in areas endemic for typhoid fever. Individuals with depressed CMI appear to be more susceptible to *S. Typhi* infections. In acute infection, O antibody appears first, rising progressively, later falling, and often disappearing within a few months; H antibody appears slightly later but persists longer. Rising or high O antibody titers generally indicate acute infection, whereas elevated levels of H antibody help to identify the type of enteric fever.

### Clinical Syndromes

*S. Typhi* causes typhoid fever, while *S. Paratyphi A*, *Salmonella* Schottmuelleri (formerly *S. Paratyphi B*), and *Salmonella* Hirschfeldii (formerly *S. Paratyphi C*) cause a mild form of this disease referred

to as paratyphoid fever. The term enteric fever includes both typhoid and paratyphoid fever caused by these *Salmonella* spp.

### ► Enteric fever

Enteric fever is generally an acute illness manifested by fever, headache, and abdominal symptoms. The incubation period is usually from 7 to 14 days, but may range from 3 to 56 days.

Onset of the disease is usually gradual, with headache, malaise, anorexia, a coated tongue, and abdominal discomfort with either constipation or diarrhea. A step-ladder pyrexia with relative bradycardia and toxemia is the typical feature. The condition is associated with a soft, palpable spleen and an enlarged liver. These symptoms are present for a week or more and are followed by gastrointestinal symptoms. This phase corresponds to an initial bacteremic phase, which is followed by colonization of gallbladder and then reinfection of the intestines.

Intestinal perforation, severe hemorrhage, and circulatory collapse are most important complications. Toxic encephalopathy, cerebral thrombosis, hepatitis, pancreatitis, arthritis, and myocarditis are other complications. Convalescence is slow.

Relapse is common after initial recovery in 10–20% of patients treated with antibiotics. A relapse typically occurs approximately 1 week after the therapy is discontinued, but relapse even after 2 months has been reported. A relapse generally is milder and shorter than the initial disease. Rarely, second or even third relapses may occur. The blood culture and serum H, O, and Vi antibodies are again positive in cases of relapse.

Paratyphoid fever caused by *S. Paratyphi A* and *B* resembles typhoid fever but is generally milder. *S. Paratyphi C* may also cause paratyphoid fever, but more often it leads to a frank septicemia with suppurative complications.

### Epidemiology

#### ► Geographical distribution

Enteric fever is endemic in many developing countries of the world and is primarily found in those countries of the developing world where sanitary conditions are poor.

Typhoid fevers are endemic in the Indian subcontinent, Southeast and Far East Asia, the Middle East, Africa, Central America, and South America. Approximately, 12–13 million cases of typhoid fever occur globally each year with 600,000 deaths. Enteric fever is endemic in all parts of India. Typhoid fever has been virtually eliminated in the developed countries due to improvements in water supply and sanitation during last many decades.

Paratyphoid fever still continues to be health problem in both developing and developed countries. *S. Paratyphi A* is prevalent in India and other Asian countries, Eastern Europe, and South America; *S. Paratyphi B* in North America, Britain, and Western Europe; and *S. Paratyphi C* in Eastern Europe and Guyana.

### ► Habitat

*S. Typhi* and *S. Paratyphi* (A, B, and C) are strict human pathogens. They are not found in any other animal hosts. They colonize the small intestine, especially ileac mucosa in infected human hosts. Asymptomatic long-term colonization occurs commonly in infected hosts.

Other salmonellae are parasitic in various domestic animals, rodents, reptiles, and birds. *S. Typhimurium* have a wide host range affecting animals, birds, and humans, while *Salmonella Abortus-equi* is found only in horses, *Salmonella Abortus-oris* in sheep, and *S. Gallinarum* in poultry.

### ► Reservoir, source, and transmission of infection

The infected patient and, more frequently, carriers are important reservoirs of infection for enteric fever.

#### Key Points

- **Convalescent carriers:** Patients who continue to excrete typhoid bacilli in feces for 3 weeks to 3 months after clinical cure.
- **Temporary carriers:** Those who shed the bacilli for > 3 months but < 1 year.
- **Chronic carriers:** Those who excrete the bacilli for > 1 year are called.

About 2–4% of patients become chronic carriers. The bacilli persist in the gallbladder and are excreted in feces (*fecal carrier*) or persist in the kidney and are secreted in the urine (*urinary carrier*). Urinary carriers are less frequent than the fecal carriers and usually present with some urinary lesion, such as calculus or schistosomiasis.

The carrier state is more common in women than in men and in the older people (over 40 years) than in young people.

Food handlers or cooks who become carriers are potentially dangerous to the community. Mary Mallon (Typhoid Mary), a New York cook was a classical case of such carrier who, over a period of 15 years, caused at least seven outbreaks affecting more than 200 persons.

Carrier stage also occurs with *S. Paratyphi* infections. *S. Paratyphi A* infection occurs only in humans, while *S. Paratyphi B* infection occurs in animals, such as dogs or cows.

Food, vegetables, and water contaminated with human feces infected by *S. Typhi* are the common sources of infection.

- *S. Typhi* infections occur when food or water contaminated by infected food handlers or due to poor personal hygiene is ingested.
- The infectious dose for *S. Typhi* infections is low, so person-to-person spread is common.
- The infectious dose is still lower for people at high risk for disease because of age, immunosuppression, or underlying disease (leukemia, lymphoma, sickle cell disease), or reduced gastric acidity.

There is no animal reservoir for typhoidal salmonellae. Animal-to-human zoonotic transmission is common in only nontyphoidal salmonellae. Poultry, livestock, reptiles, and pets are the principal reservoirs for nontyphoidal *Salmonella* organisms. Ingestion of improperly cooked fruits, vegetables, foods of animal origin, including poultry, red meats, unpasteurized milk, and eggs that have been contaminated by infected animals or an infected human is the mode of transmission. Contact with infected reptiles, such as iguanas, pet turtles, and tortoises, and ingestion of contaminated water are other modes of transmission.

### ► Classification and typing of *Salmonella*

1. **Kauffmann–White scheme:** Kauffmann–White scheme is a method of classification of *Salmonella* strains based on structural formulae of the O and H antigens of the strains, which are identified by agglutination with specific antisera. Salmonellae are classified into different O serogroups, based on the presence of distinctive O antigen factors. Each serogroup contains a number of serotypes possessing a common O factor not found in other serogroups. These O factors are now designated 1, 2, 3, 4, etc.; these were originally designated by capital letters A–Z and afterward by numbers 51–67. Some serogroups were subdivided into subserogroups (e.g., C1–C4; E1–E4). It seems logical to name each serogroup by its characteristic O antigen factor numbers, rather than by letters. Hence, it is now being proposed to designate group A as 2, B as 4, C1 as 7, C2 as 8, D as 9, and so on.

Within each O serogroup, the different serotypes are identified by the presence of phase 1 and phase 2 of flagellar antigens. The antigenic structure of a *Salmonella* serotype is designated by an antigenic formula, which has three components describing the O antigens, the phase 1 H antigen, and phase 2 H antigen in that order. Three parts are separated by colons and the component antigens in each part by commas.

The Kauffmann–White scheme designates each serotype as a species (Table 32-4). Currently, more than 2400 serotypes have been described by Kauffmann–White scheme.

2. **Bacteriophage typing:** Bacteriophage typing is the intra-species classification of *S. Typhi*, first developed by Craigie and Yen (1937). They observed that bacteriophage acting

on the Vi antigen of *S. Typhi* (Vi phage II) is highly adaptable. The parent phage is known as phage A. It could be made specific for a particular strain of *S. Typhi* by serial propagation in the strain. Such adaptation was obtained by phenotypic or genotypic variation.

The phage typing is carried out by determining the sensitivity of the cultures to a series of variants of Vi phage. However, most other types are sensitive to only one or a few related adaptations. As phage typing of *S. Typhi* depends on the presence of Vi antigens, a proportion of strains (Vi negative) will be untypable. At present, 97 Vi II phage types of *S. Typhi* are recognized. *S. Typhi* phage types E1, O, and A are most common in India.

To make phage typing more useful and more discriminative, additional markers have been used for the subdivision of strains belonging to a phage type. These include (a) Nicolle's complementary phage typing, (b) Kristensen's biotyping, (c) production of tetrathionate reductase, (d) production of bacteriocin, and (e) antibiogram. The phage typing is useful in (i) tracing the source of epidemics and (ii) providing information on the trends and patterns of typhoid epidemiology at the local, national, and international levels. Phage typing schemes have also been applied to *S. Paratyphi* A and B, *S. Typhimurium*, *S. Enteritidis*, *S. Dublin*, and other serotypes. Phage typing in India is carried out at the National Phage Typing Centres located at the Lady Hardinge Medical College, New Delhi.

3. **Biotyping:** Biotyping is a useful method to classify different *Salmonella* strains of a particular serotype into a number of biotypes by their biochemical characteristics.

On the basis of 15 different biochemical characteristics, Duguid et al. in 1975 differentiated *S. Typhimurium* into 144 different biotypes. The same biochemical characteristics have also been used to biotype *S. Paratyphi* B, *Salmonella* Montevideo, and *S. Agona*. *S. Typhi* has been differentiated into different biotypes on the basis of fermentation of arabinose, dulcitol, and xylose.

Biotyping is useful to supplement phage typing because it subdivides further a large number of untypable strains or members of common phage types. Conversely, strains of the same biotype may be reorganized into different phage types. Therefore, a combination of phage typing and biotyping provides a better discrimination of *Salmonella* strains than either method used alone.

4. **Molecular methods:** Currently, genotyping methods like plasmid fingerprinting, multilocus enzyme electrophoresis, IS-200 profiling, and random amplified polymorphic DNA analysis have been employed as more discriminating methods for epidemiological characterization of *Salmonella* in advanced centers.

The National Salmonella Reference Centre in India is located at the Central Research Institute, Kasauli (Himachal Pradesh). The reference center for salmonellae of animal origin is at the Indian Veterinary Research Institute, Izatnagar (UP). These reference centers provide services for identification of unusual serotypes and reconfirmation of other serotypes of salmonellae.

## Laboratory Diagnosis

Laboratory diagnosis of enteric fever is based on the following methods:

1. Isolation of *Salmonella* spp. by culture,
2. Serodiagnosis by demonstration *Salmonella* antibodies and antigens, and
3. Molecular diagnosis by DNA probes and PCR.

## Specimens

Blood, blood clot, bone marrow, and stool are common specimens used for isolation of typhoidal bacilli for culture. Other specimens include the cerebrospinal fluid, peritoneal fluid, mesenteric lymph nodes, resected intestine, pharynx, tonsils, abscess, bone, and urine.

TABLE 32-4

Kauffmann–White classification of *Salmonella*

O serogroup		Serotype	O antigens (and Vi)	H antigens	
New	Old			Phase 1	Phase 2
2	A	<i>Salmonella</i> Paratyphi A	1,2,12	a	—
4	B	<i>Salmonella</i> Paratyphi B	1,4,5,12	b	1,2
		<i>Salmonella</i> Typhimurium	1,4,5,12	1	1,2
		<i>Salmonella</i> Stanley	4,5,12	d	1,2
7	C1	<i>Salmonella</i> Paratyphi C	6,7 (Vi)	c	1,5
		<i>Salmonella</i> Choleraesuis	6,7	c	1,5
8	C2	<i>Salmonella</i> Muenchen	6,8,20	e,h	1,2
9	D	<i>Salmonella</i> Typhi	9,12 (Vi)	d	—
		<i>Salmonella</i> Enteritidis	4,9,12	g,m	—
		<i>Salmonella</i> Gallinarum	1,9,12	—	—
		<i>Salmonella</i> Pullorum	1,9,12	—	—
3,10	E1	<i>Salmonella</i> Anatum	3,10	e,h	1,6

## ► Culture

**Blood culture:** Blood culture is a very useful procedure for diagnosis of enteric fever. It is positive in approximately 90% of cases in the first week of fever, 75% of cases in the second week, 60% in the third week, and 25% thereafter till the subsidence of pyrexia. Blood cultures, however, rapidly become negative on treatment with antibiotics.

In this method, approximately 5–10 mL of blood is collected aseptically by venepuncture and inoculated into a culture bottle containing 50–100 mL of 0.5% bile broth. This 10-fold dilution of blood is achieved by adding 5–10 mL of blood to 50–100 mL of bile broth which is carried out to neutralize the bactericidal action of many substances that are present in the blood. The addition of liquid (sodium polyanethol sulfonate) further counteracts the bactericidal action of blood. Blood culture bottle is incubated at 37°C for up to 7 days. After incubation overnight at 37°C, the bile broth is subcultured on MacConkey agar.

Blood culture is positive in approximately 90% of cases in the first week of fever, 75% of cases in the 2nd week, 60% in the 3rd week, and 25% thereafter till the subsidence of pyrexia. Blood cultures, however, rapidly become negative on treatment with antibiotics.

**Castañeda's biphasic method of blood culture:** It is a better method of culture to reduce the risk of contamination during repeated subcultures. The method has additional advantage of being more safe and economical. In this method, the culture bottle has an agar slant in one side, which is flooded with bile broth. After inoculation of blood, the bottle is incubated in the upright position so that surface of the agar remains free without any broth covering the slant. Broth remains only in the lower part of the agar slope. For subculture, the bottle is simply tilted so that the broth flows over the surface of the agar slant and is reincubated in the upright position. If salmonellae are present, colonies appear on the agar slant (Color Photo 34).

**Clot culture:** Clot culture is a more sensitive method than the blood culture, because certain inhibitory substances that are found in the serum are absent in the clot proper. Another advantage of this method is that serum eluted from the blood during process of clotting can be used for demonstration of *Salmonella* antigens or antibodies.

In this method, 5 mL of blood is collected under strict aseptic conditions, from the patient, into a sterile test tube and allowed to clot. The serum is pipetted off and used for serological tests. The clot is broken up with a sterile glass rod and added to a bottle of bile broth containing streptokinase (100 units/mL). Streptokinase facilitates lysis of the clot with release of bacteria trapped inside the clot. The bile broth is incubated and subcultured on media in the same way as described for blood culture earlier.

**Bone marrow culture:** Bone marrow culture is a most sensitive method. It is positive in most cases even when blood cultures are negative. It is also positive even if patients have been taking antibiotics for several days, regardless of how long they have been suffering from enteric fever. This test is recommended for patients whose initial blood culture results are negative, possibly due to prior antibiotic therapy.

**Feces culture:** Feces culture is also useful because salmonellae are excreted in feces throughout the disease and even during convalescence with varying frequency. The feces is collected from the patient in a sterile container and sent immediately to the laboratory. If delay is anticipated, the stool specimens may be collected in a buffered glycerol saline transport medium. The fecal samples are inoculated directly on MacConkey, DCA, and Wilson–Blair media. Relatively, a heavy inoculation of stool is made on the Wilson–Blair media because it is highly selective. For enrichment, one tube each of selenite and tetrathionate broth is inoculated and incubated at for 12–18 hours before subculture onto selective media. The plates are incubated at 37°C overnight. *S. Typhi* produces large black colonies, with a metallic sheen on the Wilson–Blair medium. On this medium, *S. Paratyphi A* produces green colonies due to the absence of H<sub>2</sub>S production. Salmonellae form pale nonlactose fermenting colonies on MacConkey and DCA media. The colonies are identified by tests as mentioned earlier (Box 32-1). If no growth is observed after 7 days, then the culture is declared negative.

**Other specimens for culture:** Salmonellae may be isolated from several specimens by culture, but they are not usually employed. These specimens include urine, bile, rose spots, pus from suppurative lesions, CSF, and sputum. Cultures may be obtained from the gallbladder, liver, spleen, and mesenteric lymph nodes at autopsy. Isolation of the organism from blood, blood clot, or bone marrow is definitive for diagnosis of enteric fever. Fecal cultures are useful, but a positive fecal culture may occur in carriers as well as in patients. Bile culture is useful for detection of carriers.

## ► Identification of bacteria

Colonies are identified by carrying out motility test, biochemical tests, and slide agglutination with specific *Salmonella* antisera (Box 32-1).

**Slide agglutination test:** The test is performed with a loopful of growth from nutrient agar plate or slope emulsified in two drops of saline on a clean slide. If *S. Typhi* is suspected, that is, when no gas is formed from glucose, a loopful of typhoid O antiserum (factor 9/group D) is added to one drop of bacterial emulsion on the slide. The slide is rocked gently. Development

### Box 32-1

### Identifying features of *Salmonella Typhi*

1. Produces non-lactose-fermenting pale colonies on MacConkey agar.
2. Produces jet black colonies surrounded by a metallic sheen on Wilson and Blair's bismuth sulfite agar.
3. Anaerogenic; ferments glucose, mannitol, and maltose, forming acid only, but no gas.
4. Do not decarboxylate ornithine.
5. Catalase positive and oxidase negative.
6. Motile.
7. H<sub>2</sub>S positive, catalase positive, indole negative, and oxidase negative.
8. Agglutination with typhoid O antiserum (factor 9/group D) is positive.

of immediate agglutination suggests that *Salmonella* strain tested belongs to *Salmonella* group D.

Identity of *S. Typhi* is established by agglutination with the flagellar antiserum (anti-d serum). Sometimes, fresh isolates of *S. Typhi* occur in the V form and do not agglutinate with the O antiserum. Such strains may be tested for agglutination against anti-Vi serum. Alternatively, the growth scraped off in a small amount of saline is tested for agglutination with the O antiserum after boiling for 20 minutes. If the isolate is a non-typhoidal *Salmonella*, producing gas from sugars, it is tested for agglutination with O and H antisera for groups A, B, C, etc.

### ► Serodiagnosis

Serodiagnosis of enteric fever is based on detection of specific *Salmonella* antibodies in the serum, or antigen in the serum and also in urine by various serological tests.

#### Demonstration of serum antibodies

**Widal test:** Widal test is the traditional serologic test used for the diagnosis of typhoid fever. The test measures agglutinating antibodies against flagellar (H) and somatic (O) antigens of *S. Typhi* for typhoid and paratyphoid bacilli in the patient's sera. This is a tube agglutination test in which Dreyer's narrow agglutination tube with a conical bottom is used for H agglutination, and Felix's short round bottomed tube for O agglutination. The H and O antigens of *S. Typhi* and the H antigens of *S. Paratyphi A* and *B* are used in the test. The paratyphi O antigens are not used because they cross-react with the typhoid O antigen due to their sharing of antigenic factor 12. H antigens of *S. Typhi* and *S. Paratyphi A* and *B* are used individually because H antigens of these bacteria do not show any cross-reactivity with each other. *S. Typhi* 901, 'O' and 'H' strains are used for preparation of antigen.

The O antigen is prepared by culture of *S. Typhi* on phenol agar (1:800) and harvesting the growth in a small volume of saline. The saline bacterial suspension is then mixed with 20 times its volume of absolute alcohol, heated at 40–50°C for 30 minutes, centrifuged, and the deposit is resuspended in saline to the appropriate density. Chloroform is used as a preservative. It is always essential to use standard smooth strains obtained from reference centers for antigen preparation. After preparation of antigen, each batch of antigen is always compared with a standard. The H antigens are prepared by adding 0.1% formalin to a 24-hour broth culture or saline suspension of an agar culture.

The test is performed by taking equal volumes (0.4 mL) of serial dilutions of the serum (from 1/20 to 1/640) and H antigen of *S. Typhi* (TH), *S. Paratyphi A* (AH), *S. Paratyphi B* (BH) and O antigens of *S. Typhi* (TO) and mixing in Dreyer's tubes and Felix's tubes, respectively. The tubes are then incubated in a water bath at 37°C overnight. Some recommend incubation at 37°C for 4 hours, followed by overnight incubation at 4°C. Control tubes containing the antigen and normal saline are used to check for autoagglutination. The agglutination titers of the serum are read. H agglutination is characterized by the formation of loose, cotton woolly clumps, while O

agglutination by a disc-like pattern at the bottom of the tube. The supernatant fluid remains clear in both types of agglutinations. The highest dilution of the serum showing agglutination with H or O antigens suggests the antibody titer of the patient's serum. The results of the Widal test should be interpreted, taking into account the following:

1. Antibodies against H and O antigens usually appear by 7th–10th day of the illness and increase steadily till the third or the fourth week, after which it declines gradually. Hence, the blood collected before 7–10 days will be negative for antibodies.
2. Demonstration of a fourfold or more rise in titer of antibodies in a paired sample, one sample collected in the first week and second sample is collected in the third week, is more useful than demonstration of antibodies in a single serum.
3. A titer of 1/100 or more for O antibodies and 1/200 or more for H antibodies is usually suggestive of enteric fever. However, the results of a single test should be interpreted with caution. Moreover, it is necessary to obtain basal antibody titer levels in "normal sera" in different areas, before arriving at a cut off diagnostic titer for H and O antibodies.
4. An elevated level of antibodies may be present in sera of patients suffering from enteric fever in past and in sera of individuals with inapparent infection or vaccination against the enteric fever. Therefore, the mere demonstration of antibodies in the Widal test should need not be considered to be suggestive of the enteric fever.
5. Serum from an individual vaccinated with TAB vaccine may show high titers of antibodies to *S. Typhi* and *S. Paratyphi A* and *B*. However, in case of infection, high titers of antibodies will be seen only against the infecting species. H antibodies persist for many months after vaccination, but O antibodies disappear earlier within 6 months. However, in case of infection, high titres of antibodies will be seen only against the infecting species.
6. Individuals who had suffered from enteric infections in past or who have been immunized may develop an anamnestic response during an unrelated fever, such as malaria, influenza, etc. The anamnestic response shows only a transient rise of antibodies, while the antibody rise is sustained in enteric fever.
7. Patients treated early with antibiotics, such as chloramphenicol, may show a poor antibody response.

The sensitivity, specificity, and predictive values of the Widal test have been shown to vary dramatically among laboratories. This wide variation is caused by differences in antigens, techniques, and patient population. The Widal test is positive in enteric fever in only 40–60% of patients at the time of admission.

**Other serological tests:** Indirect hemagglutination, counter-current immunoelectrophoresis, indirect fluorescent Vi antibody, and indirect enzyme-linked immunosorbent assay (ELISA) for immunoglobulin M (IgM) and IgG antibodies to *S. Typhi* polysaccharide are available for diagnosis of typhoid fever with varying sensitivity and specificity. Monoclonal antibodies against *S. Typhi* flagellin have been evaluated to increase specificity of the ELISA for antibodies.

### Demonstration of serum antigens

In typhoid fever, circulating *S. Typhi* antigen is present in the serum as well as in the urine, but absent in serum of a cured case of typhoid. Hence, demonstration of serum antigen always indicates an active or recent typhoid fever. Counter-current immunoelectrophoresis, co-agglutination test, and ELISA are frequently employed for detection of circulating antigen in the serum and also in urine for diagnosis of typhoid fever with varying sensitivity and specificity.



### Molecular Diagnosis

Currently, DNA probes and polymerase chain reaction (PCR) are being increasingly evaluated for the diagnosis of typhoid fever. DNA probes, although not commercially available, have been developed for identifying *S. Typhi* from bacterial culture isolates and directly from blood. PCR is still in experimental stage.

### Treatment

Chloramphenicol was the antibiotic of choice for treatment of enteric fever since its introduction in 1948. It acts by binding to 50S bacterial-ribosomal subunits and inhibits bacterial growth by inhibiting protein synthesis. Because of low cost, for sensitive *S. Typhi* strains, chloramphenicol is still used to treat typhoid fever.

### Key Points

#### Chloramphenicol-resistant *S. Typhi*

Chloramphenicol-resistant *S. Typhi* causing an epidemic with high mortality appeared in Mexico in 1972, spreading to North America and Europe. In India the epidemics of multidrug-resistant *S. Typhi* first appeared in Calicut (Kerala) in 1972. It became endemic and was confined to Kerala till 1978. Subsequently such resistant strains appeared in many other parts of India. These resistant strains were also resistant to streptomycin, sulfadiazine, and tetracycline; it was due to a transmissible plasmid carrying resistant determinants to these antibiotics. These resistant strains were initially sensitive to ampicillin, amoxicillin, cotrimoxazole, and furazolidone, which were used for treatment. By late 1980s, *S. Typhi* strains resistant to many or all of these drugs began to appear from many parts of India.

At present, the fluoroquinolones (e.g., ciprofloxacin, pefloxacin, norfloxacin) and the third-generation cephalosporins (e.g., ceftazidime, ceftriaxone, cefotaxime) are the antibiotics of choice for treatment of multidrug-resistant *S. Typhi*. They are increasingly used for typhoid fever because of their efficacy and low relapse and low carrier rates associated with their use.

Cefotaxime prevents bacterial cell wall synthesis, which inhibits bacterial growth. The antibiotic shows excellent *in vitro* activity against *S. Typhi* and other salmonellae, and has acceptable efficacy in typhoid fever. Recently, emergence of domestically acquired ceftriaxone-resistant *Salmonella*

infections has been described. The cost and need for intravenous administration are the noted disadvantages of third-generation cephalosporins, particularly in developing countries.

A 14-day course of chloramphenicol, ampicillin, or trimethoprim and sulfamethoxazole is indicated for *S. Typhi* infection.

### Prevention and Control

Availability of safe drinking water, proper food hygiene, and sanitary disposal of excreta are the most cost-effective strategies for reducing the incidence of typhoid fever in endemic countries. These measures not only reduce the incidence of typhoid fever but also reduce other enteric infections, which are a major cause of morbidity and mortality in those areas.

#### Immunization

Immunization with typhoid vaccines at regular intervals also considerably reduces the incidence of typhoidal *Salmonella* infections. Routine typhoid vaccination is indicated for (i) persons with intimate exposure (e.g., household contact) to *S. Typhi* cases or carrier; (ii) travelers to countries associated with an increased risk of exposure to *S. Typhi*; and (iii) microbiology laboratory personnel working with *S. Typhi*. The following two types of typhoid vaccines, killed and oral, are used:

#### Killed vaccines

**TAB vaccine:** The TAB vaccine is a killed whole cell vaccine that contains heat-killed and 0.5% phenol-preserved *S. Typhi*, 1000 million/mL, and *S. Paratyphi* A and B, 750 million each per mL. The vaccine has been used for many years in India and in other countries, endemic for enteric fever. The vaccine is given subcutaneously in two doses of 0.5 mL each at an interval of 4–6 weeks, followed by a booster dose every 3 years. Field trials have shown overall efficacy of 70–90% in typhoid fever for a period of 3–7 years. Fever and pain at the site of injection are the side effects. Injection of a large volume of antigen is also another concern. Therefore, in India, divalent typhoid-paratyphoid A vaccine without *S. Paratyphi* B is used instead of the trivalent TAB vaccine, because *S. Paratyphi* B infection is not that common in the country.

**Vi capsular polysaccharide antigen vaccine (ViCPS):** The ViCPS antigen vaccine is composed of purified Vi antigen, the capsular polysaccharide produced by *S. Typhi* isolated from blood cultures. Primary vaccination with ViCPS is carried out by a single parenteral dose of 0.5 mL (25 µg IM). Booster doses are needed every 2 years to maintain protection, if continued or renewed exposure to *S. Typhi* is expected. Two field trials showed overall protection rates of 50–64% in South Africa and 72% in Nepal, the areas endemic for the disease. Fever, headache, erythema, and induration are some of the side effects. The vaccine is not recommended for children below 2 years.

**Acetone-inactivated parenteral vaccine:** This vaccine is currently available only in the United States only for military use. The vaccine has shown an efficacy of 75–94%. Booster doses are given every 3 years, if continued or renewed exposure is expected.

## Vaccine

### Oral vaccines

**Ty21a oral vaccine:** This is an oral vaccine containing live attenuated *S. Typhi* Ty21a strains in an enteric-coated capsule. *S. Typhi* Ty21a strain is a stable mutant lacking the enzyme UDP-galactose-4-epimerase. On ingestion, the strain initiates infection, but after four or five cell divisions causes self-destruction, hence lacks the capability to cause any illness. Although the mechanism is unknown, the vaccine appears to stimulate both serum and intestinal antibodies and cell-mediated immune responses.

Primary vaccination with Ty21a consists of one enteric-coated capsule, taken on alternate days, with a total of four capsules. Booster doses are needed every 5 years to maintain protection if continued or renewed exposure is expected. It is essential to store the capsules in a refrigerator at 4°C and to take all four doses to achieve maximum efficacy.

Abdominal discomfort, nausea, vomiting, fever, headache, and rash or urticaria are rare but observed side effects following vaccination.

A significant decrease in the incidence of typhoid fever occurred among persons receiving four doses of vaccine compared to those receiving two doses ( $P < 0.001$ ) or three doses ( $P = 0.002$ ) in a field trial, carried out in Chile. However, an efficacy rate of only 42% was recorded in Indonesia, suggesting that the vaccine may not be effective in areas where exposure to *S. Typhi* is intense.

The vaccine is not recommended for immunocompromised persons, including those known to be infected with HIV and for children below 6 years.

grow inside. Droppings of rats, lizards, or other small animals may also cause food contamination. Improperly prepared fruits, vegetables, dairy products, and shellfish may cause infection if contaminated through manure or by unhygienic handling.

The incubation period is 6–72 hours. Nausea, vomiting, and loose watery stools are the common symptoms. Fever, abdominal cramps, myalgias, and headache are also common. Fever, which rarely exceeds 39°C, occurs in approximately one-half of infected patients. Symptoms usually resolve spontaneously in 2–7 days.

**Laboratory diagnosis** is made by isolating the salmonellae from the feces by culture. In outbreaks of food poisoning, isolation of salmonellae from the food confirms the diagnosis.

**Treatment** of uncomplicated, noninvasive salmonellosis is symptomatic. Antimicrobial therapy is not indicated because it does not shorten the duration of illness. But for the serious invasive cases, antibiotic treatment is recommended. Treatment with antibiotics is recommended for:

- *Salmonella* gastroenteritis in infants below 3 months and in infants below 12 months with high fever and unknown blood culture results; and
- patients with hemoglobinopathies, HIV infection or other causes of immunosuppression, neoplasms, or chronic GI illnesses.

Ampicillin, amoxicillin, trimethoprim-sulfamethoxazole, cefotaxime, and ceftriaxone are effective for the treatment of the condition.

**Prevention** of food contamination at various levels, from natural infection in the animal or bird, is important for prevention of *Salmonella* gastroenteritis. Proper cooking of food is useful to destroy salmonellae contaminating the food preparations.

## Salmonella Gastroenteritis

*Salmonella* gastroenteritis is the most common form of salmonellosis. *Salmonella* gastroenteritis or food poisoning is generally a zoonotic disease, caused by certain species of nontyphoidal salmonellae, which are primarily animal pathogens. *S. Typhimurium* is the most common species causing the disease in many parts of the world. Some other common species include *S. Enteritidis*, *Salmonella* Hadar, *Salmonella* Heidelberg, *S. Agona*, *Salmonella* Virchow, *Salmonella* Seftenberg, *Salmonella* Indiana, *Salmonella* Newport, and *S. Anatum*.

Human infection usually occurs by consumption of contaminated foods. The most common sources of salmonellae are milk and milk products, meat, poultry, and eggs. Of great concern are eggs and egg products. Salmonellae can enter through the shell if eggs are left on contaminated chicken feed or feces and

## Salmonella Bacteremia

All *Salmonella* spp. can cause bacteremia. However, *S. Choleraesuis*, *S. Paratyphi*, and *S. Typhi* more commonly cause a bacteremic disease. Pediatric and geriatric patients as well as patients with AIDS are increasingly susceptible to suffer from *Salmonella* bacteremia.

The clinical presentations of *Salmonella* bacteremia are like that of other Gram-negative bacteremias. However, localized suppurative infections, such as osteomyelitis, deep abscesses, endocarditis, arthritis, and meningitis can occur in as many as 10% of patients. The case fatality may be as high as 25%.

Diagnosis of the condition is made by isolation of salmonellae from the blood or from the pus from the suppurative lesion and rarely from feces.

## CASE STUDY

A 35-year-old adult was admitted to hospital with high fever ( $>101^{\circ}\text{F}$ ), headache, and abdominal symptoms for last 10 days. He gave a history of abdominal discomfort with diarrhea. A local doctor had examined the patient 4 days back and had given a course of chloroquine for treatment of malaria, but the patient did not show any sign of improvement. A battery of tests was carried out to rule out typhoid fever.

- Describe the virulence factors of the bacteria responsible for typhoid fever.
- Describe the laboratory tests employed for diagnosis of typhoid fever.
- What are the vaccines available against the typhoid fever?
- Does the bacteria causing typhoid fever show any resistance to antibiotics? Discuss about that.



# Shigella

## Introduction

*Shigella* is the most common cause of bacillary dysentery, which occurs worldwide. The disease is spread through fecal–oral transmission, and humans are the only natural reservoir of the bacteria. Human infections caused by *Shigella* species are summarized in Table 33-1.

## Shigella

Based on a combination of biochemical and serological characteristics, shigellae are classified into four species or subgroups, consisting of more than 45 O antigen-based serogroups and each species consisting of different serotypes.

***Shigella dysenteriae* (group A):** This is subdivided into 12 serotypes. Each serotype is characterized by the presence of a different type of antigen. *S. dysenteriae* serotype 1 is the bacillus originally described by Shiga, hence known as Shiga's bacillus. *S. dysenteriae* serotypes 3–7 were described by Large and Sachs in India, and hence were known as the Large–Sachs group.

***Shigella flexneri* (group B):** This group is named after Flexner (1900), who described the first of the mannitol-fermenting shigellae from Philippines. *S. flexneri*, based on type-specific (I–VI) and group-specific (1–8) antigens, have been classified into six serotypes (1–6) and several subtypes (1a, 1b; 2a, 2b; 3a, 3b, 3c; 4a, 4b; 5a, 5b).

***Shigella boydii* (group C):** This group is named after Boyd, who first described these strains from India (1931). A total of 19 serotypes have been identified in this group. Members of *S. boydii* group resemble biochemically, but not antigenically, with those of *S. flexneri*.

***Shigella sonnei* (group D):** This group is named after Sonne, who first described these strains from Denmark (1915). *S. sonnei* have been divided into 26 colicin types by using 33 indicator strains.

## Properties of the Bacteria

### ► Morphology

*Shigella* shows following features:

- *Shigella* are short, Gram-negative rods, about  $0.5 \times 1\text{--}3 \mu\text{m}$  in size.
- They are nonmotile, nonsporing, and noncapsulated.
- *Shigella* species with exceptions of *S. flexneri*, serotype 6, and some strains of other serotypes possess fimbriae.

TABLE 33-1

### Human infections caused by *Shigella* species

Bacteria	Diseases
<i>Shigella</i> species	Shigellosis, bacillary dysentery, asymptomatic carriage, and hemolytic uremic syndrome

### ► Culture

*Shigella* are aerobes and facultative anaerobes. They grow at a temperature range of 10–40°C with an optimum temperature of 37°C and pH 7.4.

**1. Nutrient agar:** They grow on ordinary media, such as nutrient agar or Mueller–Hinton agar. *Shigella* colonies on nutrient agar, after overnight incubation, are small, circular, convex, smooth, and translucent. Occasionally on primary isolation and frequently in subcultures, a proportion of the colonies may be of the rough type.

**2. MacConkey agar:** *Shigella* spp. on MacConkey agar produce nonlactose-fermenting pale, colorless colonies. However, *S. sonnei* (which ferments lactose late) forms pale pink colonies on prolonged incubation.

**3. Selective media:** Deoxycholate citrate agar (DCA), xylose lysine deoxycholate (XLD) agar, Salmonella–Shigella (SS) agar, and Hektoen enteric (HE) agar are frequently used selective media for isolation of *Shigella* species. DCA is a useful selective medium for isolation of *Shigella* spp. from feces. On this medium, *Shigella* spp. produce small colonies, which on prolonged incubation produce lactose-fermenting pink colonies. XLD agar is another selective medium, which is less inhibitory to *S. dysenteriae* and *S. flexneri*. *Shigella* spp. forms red colonies on this medium. *Shigella* spp. on SS agar form colorless colonies. *Shigella* spp. on HE agar forms green colonies.

**4. Liquid media:** Selenite F and Gram-negative (GN) broth are commonly used enrichment media. Enrichment of feces in GN broth for 4–6 hours followed by subculture on XLD or HE medium is useful for isolation of *Shigella* from clinical specimens.

### ► Biochemical reactions

*Shigella* shows following reactions:

- *Shigella* ferments mannitol, forming acid but no gas. Mannitol fermentation test is an important biochemical test, which is used to classify shigellae into mannitol-fermenting and nonfermenting species. *S. flexneri*, *S. boydii*, and *S. sonnei* are mannitol-fermenting species, while *S. dysenteriae* is mannitol-nonfermenting species. However, exceptions are not that uncommon.

- *Shigella* also ferments glucose, producing acid but without gas. Newcastle and Manchester biotypes of *S. flexneri* type 6, and some strains of *S. boydii* types 13 and 14 are exceptions, which do not ferment glucose.
- They do not ferment lactose, sucrose, salicin, adonitol, or inositol. However, *S. sonnei* ferments lactose and sucrose late.
- They reduce nitrates to nitrites and do not form H<sub>2</sub>S.
- They are MR positive, citrate negative, and oxidase negative.
- They are catalase positive with exception of *S. dysenteriae* type 1, which is catalase negative.

The biochemical characteristics that are useful for distinguishing different *Shigella* species are listed in Table 33-2.

### ► Other properties

**Susceptibility to physical and chemical agents:** Shigellae are killed at a temperature of 55°C in 1 hour or by 1% phenol in 30 minutes. In feces, they die within a few hours due to acidity produced by the growth of intestinal bacteria. They remain viable in moist environments for days, but die rapidly on drying. *S. sonnei* is in general more resistant to unfavorable environmental conditions than the other *Shigella* species.

## Cell Wall Components and Antigenic Structure

The cell wall of shigellae, like other Gram-negative bacilli, contains a lipopolysaccharide (LPS) structure. The LPS is

liberated during lysis of the cell and, to some extent, during culture. The LPS moiety functions as an endotoxin and is an important component of the virulence of the bacteria.

### ► Antigenic structure

The antigenic structure of shigellae is simple, unlike the complex antigenic structure of salmonellae. Shigellae possess somatic O antigens and certain strains possess K antigens. *Shigella* K antigens, when present, may sometimes interfere with agglutination by O antisera. Shigellae strains also possess fimbrial antigens. Common fimbrial antigens are also found particularly in *S. flexneri*.

*S. flexneri* is biochemically heterogeneous and antigenically the most complex among shigellae. *S. flexneri*, based on type-specific (I–VI) and group-specific (1–8) antigens, have been classified into six serotypes (1–6) and several subtypes (1a, 1b; 2a, 2b; 3a, 3b, 3c; 4a, 4b; 5a, 5b) (Table 33-3). Two antigenic variants, called X and Y, which lack the type specific antigens are also recognized in addition to this. *S. flexneri* serotype 6 is always indole negative and is classified into three biotypes: Boyd 88, Manchester, and Newcastle (Table 33-4).

*S. sonnei* is antigenically homogeneous but may occur in two forms: phase I and phase II. Phase I strains produce smooth colonies, while phase II colonies form large, flat, and more irregular colonies. Cultures contain a mixture of both forms. Usually, phase II strains are isolated more frequently from convalescing cases and from carriers than from patients.

## Pathogenesis and Immunity

### ► Virulence factors

Virulence in *Shigella* species involves both chromosomal- and plasmid-coded genes, which express for many virulence factors (Table 33-5).

**Endotoxins:** The LPS moiety functions as an endotoxin and is an important component of the virulence of the bacteria. The endotoxin plays an important role in resistance of *Shigella* to nonspecific host defense encountered during tissue invasion. The toxin helps in invasion, multiplication, and resistance of *Shigella* to phagocytosis by tissue macrophages. The endotoxin increases the cytotoxic activity of Shiga toxin on human vascular endothelial cells. The endotoxin is expressed by chromosomal genes of the bacteria.

**Intestinal adherence factor:** Intestinal adherence factor is a 97-kDa outer membrane protein encoded by each gene on

TABLE 33-2 Differentiation of *Shigella* species

Characteristics	<i>Shigella dysenteriae</i>	<i>Shigella flexneri</i>	<i>Shigella boydii</i>	<i>Shigella sonnei</i>
Number of serotypes	12	6 + 2 variants	18	2 Phases; 26 colicin types
Lactose	–	–	–	–
Sucrose	–	–	–	–
Mannitol	–	+	+	+
Dulcitol	–	–	✓	–
Xylose	–	–	✓	✓
Indole	✓	✓	✓	–
Lysine decarboxylase	–	–	–	–
Ornithine decarboxylase	–	–	–	+

TABLE 33-3 Antigens of various serotypes of *Shigella flexneri*

Serotype	1		2		3			4		5		6	X variant	Y variant
Subserotype	1a	1b	2a	2b	3a	3b	3c	4a	4b	5a	5b			
Type antigen	I	I	II	II	III	III	III	IV	IV	V	V	VI	–	–
Group antigens	1, 2, 4	1, 2, 4, 6	1, 3, 4	1, 7, 8	1, 6, 7, 8	1, 3, 4, 6, 7, 8	1, 6	1, 3, 4	1, 3, 4, 6	1, 3, 4	1, 7, 8	1, 2, 4	1, 7, 8	1, 3, 4

chromosomes. This mediates colonization of *Shigella* spp. in infected human hosts and in animal models.

**Shiga toxin:** Shiga toxin is an exotoxin produced by *S. dysenteriae*. It is a heat-labile protein and acts as enterotoxin and neurotoxin. Shiga toxin (Stx) is a group of cytotoxins that contain two major immunologically non-cross-reactive groups called Stx1 and Stx2. Both Stx1 and Stx2 groups are encoded by a bacteriophage inserted into the chromosome of the bacteria. Shiga toxins have one A subunit and five B subunits:

- The main function of B subunit is to bind toxins to host cell glycolipid (Gb3) surface receptor, present on the brush border of epithelial cell of the intestines. It also mediates transfer of the A subunit into the cell.
- Subunit A is a 32-kDa polypeptide. It cleaves the 28S rRNA in the 60S ribosomal subunit, thereby preventing the binding of aminoacyl-transfer RNA and disrupting protein synthesis.

The Shiga toxin shows three types of toxic activities:

1. **Neurotoxic activity:** This activity is demonstrable by paralysis and death of experimental animal following injection with the toxin. Although called neurotoxin, the primary site of its action is not the neural tissue but is the blood vessels, neurological manifestations being secondary.

TABLE 33-4

**Biotypes of *Shigella flexneri* serotype 6**

Biochemical properties	Boyd 88	Manchester	Newcastle
Indole	–	–	–
Glucose	⊥	+	⊥ or +
Mannitol	⊥	+	–

⊥, Acid only; +, acid and gas.

TABLE 33-5

**Virulence factors of *Shigella* species**

Virulence factors	Biological functions
Endotoxins	Invasion, multiplication, and resistance of <i>Shigella</i> to phagocytosis by tissue macrophages
Intestinal adherence factor	Colonization of <i>Shigella</i>
Shiga toxin	Disrupts protein synthesis and produces endothelial damage

2. **Enterotoxic activity:** These toxins are enterotoxic for ligated rabbit intestinal segments with induction of fluid accumulation in ligated rabbit ileal loop. Two new *Shigella* enterotoxins, designated as S. ET-1 and S. ET-2—the former confined to *S. flexneri* 2a and the latter more widespread—have been identified.
3. **Cytotoxic activity:** This is demonstrated by cytotoxicity of toxin for vero, HeLa, and some selected endothelial cells, such as human renal vascular endothelial cells. This appears to be the same as vero toxin 1 (or Shiga-like toxin) produced by certain strains of *Escherichia coli* (VTEe).

The primary manifestation of Shiga toxin is damage to the intestinal epithelium of the infected host, causing diarrhea and dysentery. However, in a small number of patients, Shiga toxin can mediate damage to the glomerular endothelial cells, resulting in hemolytic urinary syndrome.

### ▶ Pathogenesis of bacillary dysentery

*Shigella* spp. produce a serious disease known as bacillary dysentery. Infection occurs by ingestion. The infectivity dose (ID) is extremely low. As few as 10 *S. dysenteriae* bacilli can cause clinical disease, whereas 100–200 bacilli are needed for *S. sonnei* or *S. flexneri* infection.

*Shigella* spp. cause disease by invading and replicating in cells lining the intestinal mucosa of the colon. Structural proteins, such as intestinal adhesion factor, endotoxin, and exotoxin mediate the adherence of the bacteria to the cells as well as their invasion, intracellular replication, and cell-to-cell spread. The bacilli infect the epithelial cells of the villi in the large intestine and multiply inside them. Subsequently, bacteria spread laterally to involve adjacent cells and penetrate into the lamina propria (Fig. 33-1). *Shigellae* lyse the phagocytic vacuole and multiply in the host cell cytoplasm. *Shigellae* survive phagocytosis by inducing programmed cell death or apoptosis. This mechanism also leads to the release of interleukin-1 $\beta$  resulting in the attraction of polymorphonuclear leukocytes into the infected tissues. This in turn alters the integrity of the intestinal wall and allows the bacteria to reach the deeper epithelial cells. Shiga toxin produced by the bacteria also plays an important role in progression of mucosal lesions after invasion of the colonic cells. The toxin also induces vascular damage in the colonic mucosa.

Mucosal edema, erythema, friability, superficial ulceration, and focal mucosal hemorrhage involving the rectosigmoid junction are the typical pathological features primarily observed in the condition.

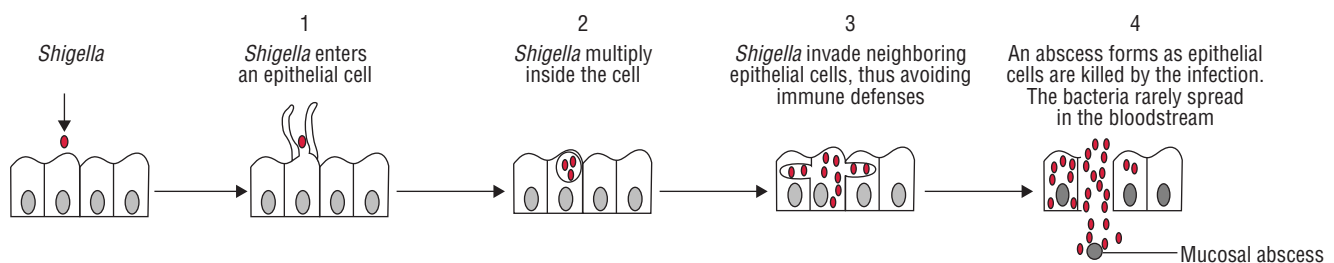

FIG. 33-1. Schematic diagram showing pathogenesis of bacillary dysentery.

## Clinical Syndromes

*Shigella* spp. cause shigellosis, a clinical syndrome encompassing the whole spectrum of disease caused by the bacteria. Bacillary dysentery is a severe clinical form of the shigellosis.

**Bacillary dysentery:** It is an acute gastrointestinal illness manifested by fever, vomiting, abdominal cramps, and tenesmus. Incubation period is usually short. It lasts from 12 hours to 7 days, usually 48 hours, and is inversely related to the load of ingested bacilli. The condition manifests with a sudden onset of high-grade fever along with abdominal cramp, tenesmus, urgency, and passage of loose, scanty feces containing frank blood and mucus.

Infection is usually self-limiting. In a small number of patients, asymptomatic colonization of shigellae occurs in the colon, which makes the patient a persistent reservoir for infection. Complications are most often associated with *S. dysenteriae* type 1 infection. These include:

- Arthritis, toxic neuritis, conjunctivitis, and, in children, intussusception.
- Hemolytic uremic syndrome may also occur following infection with *S. dysenteriae* because of vasculopathy mediated by Shiga toxin.
- Reiter syndrome (arthritis, urethritis, conjunctivitis) is usually observed in adults with HLA-B27 histocompatibility antigen.
- *Shigella* septicemia is rare, except in malnourished children with *S. dysenteriae* infection.
- Disseminated intravascular coagulation, bronchopneumonia, and multiple organ failure may occur in lethal cases of *Shigella* septicemia.

In patients with HIV infection, shigellosis is often a protracted, chronic, relapsing disease, even when treated with antibiotics and may be complicated by bacteremia.

*S. sonnei* causes the mildest form of bacillary dysentery in many patients; the species may cause only a mild diarrhea. *S. flexneri* and *S. boydii* causes more severe illness than that caused by *S. sonnei*.

## Epidemiology

Shigellosis occurs worldwide. Estimated 150 million cases occur annually worldwide. The incidence of shigellosis in developing countries is nearly 20 times more than in developed countries.

- It is estimated that 30% of these infections are caused by *S. dysenteriae*.
- *S. flexneri* is the most common cause of shigellosis in developing countries.
- *S. sonnei* is the most common cause in the industrial world.

## Geographical distribution

Shigellosis is worldwide in distribution but shows a lot of variations epidemiologically between the nature and extent of the infection in the industrially advanced and in the developing and poor countries. Endemic shigellosis is found in all age groups and is caused by all species in developing countries

where environmental sanitation is poor. In India, *S. flexneri* is the major species and constitutes 50–85% of all *Shigella* isolates followed by *S. dysenteriae* (8–25%), *S. sonnei* (2–24%), and *S. boydii* (0–8%).

## Habitat

*Shigella* species are strict human pathogens. They are found in the large intestine of infected human hosts. They are not found in any other animal hosts.

## Reservoir, source, and transmission of infection

Infected patients or, less often, carriers are reservoirs of infections for shigellosis. Chronic carriage is rare, because the bacilli are not excreted in feces within a few weeks, except in some malnourished children or in patients with AIDS. Shigellosis is transmitted by:

- **Fecal–oral route** by hand-to-mouth infection through contaminated fingers. Because as few as 10–200 bacilli can cause disease, shigellosis spreads rapidly in areas where sanitary standards and the level of personal hygiene are low.
- **Contaminated food and water:** Food and water contaminated with human feces containing *Shigella* spp. is the main source of infection.
- **Fomites** such as door handles, water taps, lavatory seats.
- **Flies**, which may transmit the infection as mechanical vectors.
- **Sexually** among young male homosexuals due to oro-anal contact.

Shigellosis is primarily a disease of children. Nearly, 70% of all infections occur in children younger than 15 years. Patients at highest risk for disease are malnourished children, young children in daycare centers, nurseries, and custodial institutions; siblings and parents of these children. *Shigella* infection in malnourished children often causes a vicious cycle of further impaired nutrition, recurrent infection, and further growth retardation. Endemic disease in adults is common in household contacts of infected children and in male homosexuals.

## Typing of *Shigella*

For epidemiological purposes, *Shigella* species have been classified into many colicin types, depending upon the biochemical characteristics of the microorganisms.

## Laboratory Diagnosis

### Specimens

Stool is the specimen of choice. Diagnosis of shigellosis is made by isolating *Shigella* spp. from feces. Fresh feces are inoculated without delay or transported in a suitable medium, such as Sachs' buffered glycerol saline, pH 7.0–7.4. Also, rectal swabs may be taken from the site of ulcer by sigmoidoscopy. However, rectal swabs that do not contain copious volume of stool or mucus are not satisfactory.

## ► Microscopy

Routine microscopy of stool may reveal clumps of polymorphonuclear leukocytes. Fecal blood or leukocytes are detectable in the stool in approximately 70% of cases of shigellosis.

## ► Culture

A sample for stool is obtained in all suspected cases of shigellosis for culture. Usually, more than one stool or rectal swab is collected and inoculated immediately on at least two different culture media, such as MacConkey, XLD, DCA, or eosin-methylene blue agars. For enrichment, one tube each of selenite F and GN broth are inoculated and incubated at 37°C for 12–18 hours before subculture onto selective media. After overnight incubation, *Shigella* produces pale nonlactose-fermenting colonies on MacConkey and DCA media and red colonies on XLD medium and colorless colonies on SS agar.

## ► Identification of bacteria

Pale non-lactose-fermenting colonies on MacConkey agar are identified by carrying out motility test, biochemical tests, and slide agglutination test with specific *Shigella* antisera (polyvalent and monovalent sera) (Box 33-1).

## ► Serodiagnosis

Serological tests are not useful in the diagnosis of shigellosis.

## Treatment

Uncomplicated shigellosis is a self-limited condition and patients usually recover spontaneously in a few days. Hence, no antibiotics are recommended for these cases. The dehydration observed in acute cases, particularly in infants and young children, needs adequate replacement of fluids and electrolytes by oral fluid and salts. Antibiotic treatment for *Shigella* infection is recommended (*i*) for severe or toxic cases and (*ii*) for the very young, debilitated, and the aged individuals. Antibiotic treatment is recommended to decrease the duration of illness, person-to-person spread, and cases in household contacts.

In developing countries, treatment in malnourished children is likely to reduce the risk of worsening malnutrition morbidity

### Box 33-1 Identifying features of *Shigella* species

1. Produces nonlactose-fermenting pale colonies on MacConkey agar, DCA agar, and SS agar; red colonies on XLD agar, and green colonies on HE agar.
2. Nonmotile.
3. Ferments glucose with exception of some strains producing acid only, but no gas.
4. Mannitol fermentation test is used to classify shigellae into mannitol-fermenting and -nonfermenting species.
5. Do not ferment lactose, sucrose, salicin, adonitol, or inositol.
6. Catalase positive with exception of *S. dysenteriae* type 1.
7. H<sub>2</sub>S negative, urease positive, citrate negative, and oxidase negative.

following shigellosis. Prophylactic antibiotics are not recommended for contacts.

Trimethoprim-sulfamethoxazole, ampicillin, tetracycline, and the quinolones, such as nalidixic acid and ciprofloxacin, are frequently used antibiotics. Trimethoprim-sulfamethoxazole is very effective for shigellosis. The antibiotics act against *Shigella* by producing a sequential blockade in folic acid synthesis. This is the drug of choice when antibiotic susceptibility of the bacteria is not known. However, ampicillin is still the drug of choice if *Shigella* isolate is susceptible to this drug.

**Antibiotics-resistant *Shigella*:** Multiple-antibiotics-resistant plasmids are widely prevalent in shigellae and were first documented in Japan during early 1950s. Most of these strains were resistant to streptomycin, chloramphenicol, and sulfonamides. Indiscriminate use of the antibiotics has worsened the problem. Hence, it is essential to treat the cases of shigellosis with the results of *in vitro* antibiotic susceptibility testing of *Shigella*.

## Prevention and Control

In developed countries, person-to-person transmission is the most common source of infection. Water contaminated with human excreta is the most common source of infection. Therefore, control consists essentially in improving personal and environmental sanitation. Antibiotics are not used in prophylaxis. No effective vaccine is available.

### CASE STUDY

A 7-year-old child was admitted to the causality for treatment of bloody diarrhea and abdominal pain for 48 hours. Her mother gave a history of her child vomiting few times and mentioned that the child developed these symptoms after she took food at a fast food counter. Sigmoidoscopy showed mucosal erythema, petechiae with pus, but no ulcer.

- List the causative bacterial agent for the disease.
- List virulence factors of the bacteria.
- Describe the epidemiology of the disease caused by the bacteria.
- Discuss the treatment of the condition.

# Yersinia

## Introduction

The genus *Yersinia* is now assigned to the family Enterobacteriaceae. Earlier, the plague bacillus and many other Gram-negative, short bacilli that are primary pathogens of rodents were included in the genus *Pasteurella*. Now, this group has been divided into three genera: *Yersinia*, *Pasteurella*, and *Francisella*. The genus *Yersinia* is now included in the tribe Yersinieae in the family Enterobacteriaceae and includes 11 species, three of which are pathogenic in humans. Human infections caused by *Yersinia* species are summarized in Table 34-1.

- *Yersinia pestis* is the most important species that causes plague, an acute and contagious, febrile illness transmitted to humans by the bite of an infected rat flea. *Yersinia enterocolitica* is other species, which causes mesenteric lymphadenitis especially in children.
- *Yersinia pseudotuberculosis* causes mesenteric adenitis.

## Yersinia pestis

Plague, caused by *Y. pestis*, was one of the most devastating diseases in history. Plague has caused large-scale epidemics, thereby changing the course of history in many nations. It has been estimated that up to 200 million people have died from this disease. In the early 20th century, plague epidemics were responsible for about 10 million deaths in India.

## Properties of the Bacteria

### ► Morphology

*Y. pestis* shows the following features:

- *Y. pestis* is a Gram-negative coccobacillus that measures 1.5–3.0–7 μm in size, with rounded ends and convex sides.
- The bacilli are arranged in single, in pairs, or in short chains. Pleomorphism is very common. Involution forms, such as coccoid, club-shaped, and filamentous forms are seen in old cultures or when grown on an unfavorable medium, such as nutrient agar containing 3% NaCl.
- Giemsa or methylene blue stained smears of clinical specimens show characteristic bipolar staining (*safety pin appearance*) with both ends densely stained and a clear central area of the bacteria.
- *Y. pestis* is a nonmotile, nonsporing, and non-acid fast but capsulated bacterium.

### ► Culture

*Y. pestis* is aerobic and facultatively anaerobic. It grows at a temperature range of 2–45°C with an optimum temperature of 27°C (unlike most bacteria), but it grows better at 37°C in culture. The bacteria grow at a wide range of pH (5–9.6), with an optimum pH of 7.2.

**Solid media:** *Y. pestis* can grow on a variety of media including Mueller–Hinton agar, nutrient agar, blood agar, and MacConkey agar. On nutrient agar, *Y. pestis* produces small, delicate, and transparent colonies becoming opaque on prolonged incubation. Blood agar containing sodium azide

TABLE 34-1

Human infections caused by *Yersinia* species

Bacteria	Diseases
<i>Yersinia pestis</i>	Plague (bubonic, pneumonic, and septicemic)
<i>Yersinia enterocolitica</i>	Enterocolitis primarily in young children Lymphadenitis with terminal ileitis (pseudoappendicitis syndrome) Extraintestinal infections (cellulitis, conjunctivitis, meningitis, osteomyelitis, pharyngitis, pneumonia, and urinary tract infection): rare
<i>Yersinia pseudotuberculosis</i>	Gastroenteritis (mesenteric lymphadenitis simulating acute appendicitis) Izumi fever Far East scarlatinoid fever Other manifestations (erythema nodosum, arthralgias, reactive arthritis, ankylosing spondylitis; terminal ileitis and intussusception, especially in children)

(7 µg/mL) is a selective medium for *Y. pestis*. Colonies on blood agar are dark brown due to the absorption of the hemin pigment. The bacteria grow poorly on MacConkey agar and deoxycholate citrate agar, producing pinpoint reddish colonies after 24 hours of incubation.

**Liquid media:** In broth, *Y. pestis* produces a flocculent growth with granular deposit at the bottom and along the sides of the tube, with little or no turbidity. On prolonged incubation, a delicate pellicle may form at the surface. *Y. pestis* produces a characteristic growth when grown in a flask of broth with oil or *ghee* (clarified butter) floated on top (*ghee* broth). The growth in the medium appears to hang down into the broth from the surface, resembling stalactites (*stalactite growth*).

### ► Biochemical reactions

*Y. pestis* shows following:

- *Y. pestis* is catalase positive, aesculin positive, and MR positive.
- It is coagulase positive.
- It ferments glucose, maltose, and mannitol with production of acid but no gas. Lactose, sucrose, or rhamnose are not fermented.
- It is oxidase negative, urease negative, and citrate negative.
- It does not reduce nitrate and does not liquefy gelatin. Indole is not produced.

### ► Other properties

**Susceptibility to physical and chemical agents:** *Y. pestis* is sensitive to heat, sunlight, drying, and chemical disinfectants. The bacilli are killed at a temperature of 55°C in 30 minutes. They are also killed rapidly by disinfectants, such as 0.5% phenol in 15 minutes. The bacilli remain viable for long periods in sealed agar slopes, in frozen tissue, and in cold and moist environments, such as in the soil of rodent burrows. All strains are lysed by a specific antiplague bacteriophage at 22°C.

## Cell Wall Components and Antigenic Structure

The cell wall of *Y. pestis* contains a lipopolysaccharide that functions as an endotoxin and is an important component of the virulence of the bacteria.

### ► Antigenic Structure

*Y. pestis* is antigenically homologous; hence no serotypes are present. The antigenic structure of the bacteria is complex and contains about 20 different antigens. *Y. pestis* possess following major antigens, which are of importance in the pathogenesis of disease:

**V and W antigens:** These two antigens are always present together. V antigen is a protein of molecular weight 90 kDa, while W antigen is an acidic 145 kDa lipoprotein. These two proteins are produced by virulent strains of *Y. pestis* when grown at 37°C in the presence of low concentration of calcium. Production of V and W antigens is mediated by plasmid.

**F1 envelope antigen:** F1 envelope antigen (fraction I or F-I antigen) is a heat-labile envelope protein generally present only in virulent strains. The antigen is formed *in vivo* and *in vitro* in culture of virulent strains at 37°C. Production of F-I antigen is mediated by plasmid. The antibody to F-I antigen is protective in mice.

## Pathogenesis and Immunity

*Y. pestis* is a highly virulent bacterium, which causes plague with a high mortality rate. The ability of *Yersinia* species to resist phagocytic killing is the hallmark of pathogenesis of plague. Serum resistance and the ability of the bacilli to absorb organic iron as a result of a siderophore-independent mechanism further contributes to the pathogenesis of the disease.

### ► Virulence factors

*Y. pestis* produces many toxins and enzymes, all of which contribute to pathogenesis of the diseases. Virulence factors of *Y. pestis* like that of *Salmonella* are complex. These are encoded both on the organism's chromosome and on large plasmids (Table 34-2).

**Plague toxin:** The term “plague toxins” refers to a complex of at least two different types of toxins: (a) endotoxin and (b) murine toxin, found in culture filtrates or in cell lysates.

- A. The endotoxin is a lipopolysaccharide found in the cell wall and is responsible for many of the systemic manifestations of the disease caused by *Y. pestis*.

TABLE 34-2

Virulent factors of *Yersinia pestis*

Virulence factors	Biological functions
Plague toxin	Causes systemic manifestations of plague
F1 envelope antigen	Inhibits phagocytosis
V and W antigens	Inhibit phagocytosis and intracellular killing of the plague bacillus inside macrophages
Type III secretion systems	Facilitate secretion of virulence factors of <i>Y. pestis</i> into host cells Prevent phagocytic killing of the pathogenic <i>Yersinia</i> species
Plasminogen activator (pla) protease	Degrades C3b and C5a components of the complement Also degrades fibrin clots
Yersinia Outer Membrane Proteins(YOPs)	Cell surface adhesion, iron acquisition, inhibition of phagocytosis and intracellular killing.

**B.** Murine toxins exhibit some properties of both exotoxins and endotoxins.

- (i) It is a heat-labile protein. The toxins may be toxoided but do not diffuse freely into the medium and are released only by the lysis of the cell.
- (ii) The toxin is pathogenic in rats and mice but not in guinea pigs and rabbits and in humans and other primates. The murine toxins produce local edema and necrosis with systemic effects on the peripheral vascular system and liver in experimental animal infections. The role of murine toxins in the pathogenesis of plague in humans is not known.

**F1 envelope antigen:** F1 envelope antigen is a major virulence factor, which inhibits phagocytosis and plays an important role in conferring protective immunity in humans and in mice.

**V and W antigens:** These two antigens inhibit phagocytosis and intracellular killing of the bacillus inside macrophages.

**Type III secretion systems:** Type III secretion systems (TTSS) consist of many proteins, which facilitate secretion of virulence factors of *Y. pestis* into host cells. The ability of the pathogenic *Yersinia* species to resist phagocytic killing is mediated by the TTSS. The bacteria on coming in contact with phagocytic cells in infected hosts secrete a variety of proteins, which prevent phagocytic killing of the bacteria. Firstly, the proteins secreted into the phagocyte dephosphorylate several proteins required for phagocytosis (YopH gene product) and then induce cytotoxicity by disrupting actin filaments (YopE gene product). Subsequently, proteins initiate apoptosis in macrophages (YopJ/P gene product). The TTSS also inhibits production of cytokines, which in turn reduces the inflammatory immune response to infection.

**Other virulence factors:** *Yersinia* produces the enzymes, such as coagulase, fibrinolysin, and plasminogen activator (pIa) protease, which contributes to virulence of the bacterium. For example, enzyme plasminogen activator (pIa) protease degrades C3b and C5a components of the complement, thereby preventing opsonization and phagocytic migration, respectively. The enzyme also degrades fibrin clots, thereby facilitating *Y. pestis* to spread rapidly. The virulence of the bacterium is enhanced further by its ability to absorb organic iron as a result of a siderophore-independent mechanism.

### ► Pathogenesis of plague

Plague in humans can occur either by the bite of a vector, by close contact with infected tissue or body fluids, or by direct inhalation of the bacterium.

**Bubonic plague:** It is a zoonotic disease transmitted by rat flea *Xenopsylla cheopis* from animals to humans. *Y. pestis* is a natural parasite of rodents; infection is transmitted and maintained among them by rat fleas. The fleas acquire the infection by feeding on infected rodents. When rat flea bites an infected and diseased rat, it sucks nearly 0.5 mL of blood per feed containing nearly 5000–50,000 plague bacilli. In the stomach of the flea, the bacilli multiply to such an extent that they block the proventriculus and thereby prevent food entry into the stomach. The interval between the ingestion of infected blood

and blocking in the proventriculus is referred to as extrinsic incubation period, which varies from 2 to 3 weeks in *X. cheopis*.

The blocked flea, to overcome starvation, begins a blood-sucking rampage by biting other rodents. Between its attempts to swallow, the distended bacillus-packed stomach recoils, depositing the bacilli into the victim's skin, thereby transmitting the infection. When the diseased rat dies, the fleas leave the carcass and in the absence of another rat, may bite human, causing bubonic plague.

The bubonic plague is characterized by the pathognomonic “bubo”. The disease occurs following the bite of rat flea, depositing thousands of bacilli into the host's skin during blood meals. The bacilli migrate to the regional lymph nodes, where they are phagocytosed by the polymorphonuclear cells and mononuclear phagocytes, and multiply intracellularly.

The bacilli invade the nearby lymphoid tissue producing the characteristic—an inflamed, necrotic, and hemorrhagic—lymph node known as *bubo* (bubon meaning groin), as demonstrated in bubonic plague. Infected lymph nodes show large number of plague bacilli, destruction of the normal architecture, and medullary necrosis.

Subsequent spread of bacteria occurs along the lymphatic channels towards the thoracic duct, with eventual distribution of the bacteria in circulation leading to bacteremia and septicemia. The bacteria, in the absence of specific therapy, potentially infect every organ, including the lungs, liver, spleen, kidneys, and rarely even the meninges.

**Pneumonic plague:** It is transmitted from humans to humans. It occurs following direct inhalation of the bacilli by droplet infection due to close contact with infected hosts or by inhalation of aerosolized bacteria, such as may occur if used as a biological weapon. The bacilli spread through the lungs, producing a severe and rapidly progressive multilobar bronchopneumonia, subsequently leading to bacteremia and septicemia. It is not a zoonotic disease.

**Septicemic plague:** It is usually the terminal stage of the bubonic or pneumonic plague. It may sometimes occur primarily. Primary septicemic plague may occur when the plague bacilli are deposited directly in the circulation, bypassing the lymphatics. Early dissemination with sepsis occurs, but without the formation of a bubo. This usually is observed in individuals bitten by the rat flea in the oral, tonsillar, and pharyngeal area and is due to the vascularity of the tissue and short lymphatic distance to the thoracic duct.

### ► Host immunity

An attack of plague provides a long-lasting immunity to infected humans.

## Clinical Syndromes

*Y. pestis* causes plague, which occurs in three forms: (a) bubonic plague, (b) pneumonic plague, and (c) septicemic plague.

### ► Bubonic plague

Bubonic plague is the most common clinical form of the disease. The incubation period varies from 2 to 6 days. The



condition is associated with a sudden onset of high fever, chills, and headache, and also body aches, extreme exhaustion, abdominal pain, and diarrhea. Presence of painful, swollen lymph glands (*buboes*), usually in the groin, axilla, or neck, is the characteristic manifestation. The buboes are unilateral, oval, and extremely painful. They measure 2–10 cm in size. Inguinal lymph nodes are most commonly involved. Enlargement of the buboes may cause rupture and discharge of foul-smelling pus. Hepatomegaly and splenomegaly may occur causing tenderness. Mortality rate for untreated plague is 40–70%.

### ► Pneumonic plague

Abrupt onset of fever and chills, lymphadenopathy, chest pain, dyspnea, purulent sputum, or hemoptysis are the manifestations of pneumonic plague. Buboes may or may not be present in pneumonic plague. Pneumonic plague is highly infectious and transmitted by aerosol droplets. The condition if untreated is invariably fatal.

### ► Septicemic plague

Septicemic plague is usually the terminal event in the bubonic or pneumonic plague, but may sometimes occur primarily in elderly patients. The condition is associated with a rapid onset of symptoms, such as nausea, vomiting, abdominal pain, and diarrhea. Diarrhea may be the predominant symptom. Patients have a toxic appearance due to an overwhelming infection with the plague bacillus and may present with tachycardia, tachypnea, and hypotension. Hypothermia is common. Generalized purpura leading to necrosis and gangrene of the distal extremities may be observed. Buboes are not demonstrated in septicemic plague. Septicemic plague is associated with a high mortality rate, and patients usually die due to a high level of bacteremia.

## Epidemiology

Plague is worldwide in distribution with most of the human cases reported from developing countries.

### ► Geographical distribution

Most cases of plague occur in the developing countries of Africa and Asia, including Vietnam and India. India is one of the few countries that have been worst hit by the pandemics of plague. Plague first appeared in Bombay in 1896 and spread all over the country, causing more than 10 million deaths by 1918. Thereafter, it gradually receded, though occasional cases continued to occur in endemic foci till 1967.

Thereafter, no cases of plague were seen in India till August 1994, during which outbreaks of bubonic plague were reported from Beed district of Maharashtra. One month later, in September 1994, outbreak of pneumonic plague was reported in Surat and adjoining areas of Gujarat and Maharashtra. Nearly, 6000 suspected plague cases and 60 deaths were reported in these outbreaks, which subsided in 2 months. Four fatal cases of plague were reported during an outbreak of plague near Shimla (Himachal Pradesh) in February 2002.

In India, at least four natural foci of plague are known, which have contributed to survival of the plague bacilli. These include:

- The place near Kolar at the tri junction of Tamil Nadu, Andhra Pradesh, and Karnataka;
- Beed-Latur belt in Maharashtra from where the Surat epidemic started;
- Rhoru in Himachal Pradesh where the 2002 outbreak originated; and
- A small pocket in Uttaranchal.

### ► Habitat

*Y. pestis* inhabit infected lymph nodes—most commonly inguinal lymph nodes in bubonic plague, lower respiratory tract in pneumonic plague, and the blood circulation in septicemic plague.

### ► Reservoir, source, and transmission of infection

Plague is a zoonotic infection transmitted to humans by the bite of an infected rat flea. Infection may also be transferred by contamination of the bite wound with the feces of infected rat fleas. Human-to-human transmission is rare except during epidemics of pneumonic plague. There are two natural cycles of plague: the urban plague and the wild plague (Fig. 34-1).

**Urban or domestic plague:** Urban plague is maintained in rat populations and is transmitted among rats or between rats and humans by infected rat fleas. In India during earlier years, plague produced epizootics first in sewer rat, *Rattus norvegicus*. When their number decreased, the disease spread to the domestic rat, *Rattus rattus*. Domestic rat is the important reservoir of urban plague from which the infection spreads to human beings. The rat flea is the usual vector. Thirty different flea species have been identified as vectors, the most important being *Xenopsylla cheopis*, *Xenopsylla astia*, and *Ceratophyllus fasciatus*. *X. cheopis* is the predominant species in north India, while *X. astia* is in the south India.

Cool and humid seasons favor the multiplication of fleas, leading to a high “flea index” (mean number of fleas per rat). Hence, plague epidemics occur during the cold season more frequently than in the hot, dry weather, in which fleas do not thrive and the transmission of infection is interrupted.

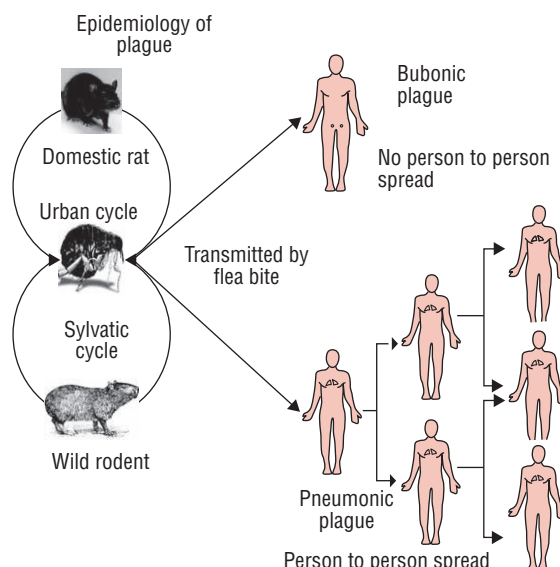

FIG. 34-1. Epidemiology of plague.

**Wild or sylvatic plague:** This occurs between animals and wild rodents independent of human beings. More than 200 different animal species have been identified as hosts. These include domestic cats and dogs, squirrels, chipmunks, marmots, deer mice, rabbits, hares, rock squirrels, camels, and sheep. In India, the gerbil (*Tatera indica*) and the bandicoot are reservoirs for sylvatic plague.

A sylvatic stage occurs when humans are infected from these wild animals. Human infection may occur during handling of dead carcasses of infected wild animals and through the ingestion of meat of infected animals. Human infection from inhalation of respiratory droplets from infected cats has also been documented.

In enzootic foci, infected fleas may survive for over a year. The bacilli remain alive and even multiply in the soil of unused rodent burrows. Plague bacilli infect new rodents that live in such burrows. This contributes for the long period of quiescence and subsequent reemergence of plague.

Sylvatic plague is difficult to eliminate because the mammalian reservoirs and flea vectors are widespread. Human-to-human spread occurs only in pneumonic plague. Pneumonic plague is spread by droplet infection and may be seen during epidemics of bubonic plague. Rarely, primary pneumonic plague may occur in epidemic form, as observed in Manchuria during 1910–1912, causing nearly 60,000 deaths.

### ► Typing

Based on the fermentation of glycerol and reduction of nitrate, *Y. pestis* has been typed to three distinct types: *Y. pestis* var. *orientalis*, *Y. pestis* var. *antiqua*, and *Y. pestis* var. *medievalis* (Table 34-3). These biotypes show different geographical distributions. Primary foci of *Y. pestis* var. *orientalis* are India, Myanmar, and China. This biotype is also responsible for wild plague in Western USA, South America, and South Africa. *Y. pestis* var. *antiqua* is distributed in Mongolia, Manchuria, and Transbaikalia. *Y. pestis* var. *medievalis* is restricted to Southeast Russia.

## Laboratory Diagnosis

### ► Specimens

These include bubo aspirates (in bubonic plague), sputum (in pneumonic plague), and blood and cerebrospinal fluid (CSF) (in septicemic plague).

### ► Microscopy

Bubo aspirates is collected by injecting 1 mL of sterile saline into the bubo with a 20-G needle. The fluid is aspirated thereafter by withdrawing several times. The bubo aspirate smears

are stained with Gram, Wright, Wayson, or Giemsa stain for demonstration of the typical bipolar (safety pin) morphology of *Y. pestis*. Blood and CSF of patients who are septicemic can also be stained to reveal the bacteria.

### Key Points

- Gram stain of the aspirate of the fluid from the inguinal lymph nodes shows Gram-negative coccobacilli with a characteristic bipolar appearance that resembles a closed safety pin and also shows polymorphonuclear leukocytes.
- Wayson stain of the aspirate smear shows *Y. pestis* as light-blue bacilli with dark-blue polar bodies. A direct fluorescent antibody test employing monoclonal antibodies is a rapid diagnostic method to demonstrate *Y. pestis* F1 antigen in blood or sputum samples. A positive fluorescence antibody test on smears or cultures is presumptive evidence of infection.

### ► Culture

Isolation of *Y. pestis* by culture confirms the diagnosis of plague. The organism can be isolated from blood, CSF, sputum, and bubo aspirates, depending on the clinical presentation, whether it is bubonic, pneumonic, or septicemic. *Y. pestis* is slow growing, but it does not require any special growth media. Clinical specimens are inoculated on blood or nutrient agar and on specialized selective media for isolation of *Y. pestis*. Selective medium, such as blood agar with sodium azide is used for selective isolation of *Y. pestis* from sputum and bubo aspirates containing numerous other bacteria.

### ► Identification of colonies

Dark-brown colonies on blood agar and pinpoint colonies on MacConkey agar are the characteristic features of colonies of *Y. pestis*. The identifying features of *Y. pestis* colonies are summarized in Box 34-1.

### ► Animal inoculation

*Y. pestis* can be isolated from bubo aspirate or sputum by inoculating in guinea pigs or white rats. The bubo aspirate is injected subcutaneously into the animal. *Y. pestis* causes death of the animal within 2–5 days. Postmortem of the dead animal shows necrosis and edema at the site of inoculation. Draining lymph nodes are enlarged, congested and show grayish white patches. Gram- and methylene blue-stained smears of lymph nodes, spleen, and heart blood reveal typical bipolar stained Gram-negative bacilli.

### Box 34-1

### Identifying features of *Yersinia pestis*

1. Gram-stained smear shows typical bipolar (*safety pin*) morphology of *Y. pestis*.
2. Dark-brown colonies on blood agar.
3. Pinpoint colorless colonies on MacConkey agar.
4. Motile at 22°C.
5. Produces indole.
6. Ferments glucose, maltose, and mannitol with production of acid and gas.

TABLE 34-3

Differentiation between biotypes of *Yersinia pestis*

	Nitrate reduction	Glycerol fermentation
<i>Yersinia pestis</i> var. <i>orientalis</i>	+	–
<i>Yersinia pestis</i> var. <i>antiqua</i>	+	–
<i>Yersinia pestis</i> var. <i>medievalis</i>	–	+

Sputum collected from suspected cases of pneumonic plague is inoculated by applying them over the shaven skin or to the nasal mucosa of a guinea pig. The bacteria present in the specimen penetrate the skin through minute abrasions. Bacilli are demonstrated in the sputum and in the blood from the heart of the guinea pig, which dies 2–3 days after inoculation.

### ► Serodiagnosis

Serological tests usually supplement diagnosis of plague. Enzyme-linked immunosorbent assay (ELISA) and indirect hemagglutination (IHA) tests are employed to detect specific antibodies in acute and convalescent sera. A fourfold or greater difference in antibody titer between acute and convalescent sera collected 10 days apart, demonstrated by ELISA or IHA, suggests plague infection. A single positive ELISA or IHA test in a patient who has not received plague vaccine nor has had previous plague is also presumptive of infection.



### Molecular Diagnosis

Polymerase chain reaction (PCR) has been evaluated for detection of *Y. pestis* genome in bubo aspirates. Though not yet widely available, it shows promise.

### Treatment

Treatment of a suspected case of plague with antibiotics should be started as early as possible, without waiting for laboratory confirmation. Immediate treatment with antibiotics has dramatically reduced mortality due to the disease. Streptomycin, doxycycline, and chloramphenicol are used effectively for treatment of plague. Treatment with antibiotics is usually given for a duration of 10 days. A two-drug regimen should be used in severe cases. Streptomycin is the drug of choice to treat plague. Doxycycline is given in patients who are allergic to streptomycin or who cannot tolerate streptomycin. Chloramphenicol is the drug of choice in septicemic plague or for patients with hypotension. In patients with hypotension, intramuscularly administered streptomycin may be poorly absorbed. Resistance of *Y. pestis* to streptomycin, gentamicin, doxycycline, and chloramphenicol is very rare.

### Prevention and Control

These include immunoprophylaxis by plague vaccine, chemoprophylaxis by antibiotic therapy, and environmental sanitation.



### Vaccines

A killed vaccine for plague is available in India. It is a whole culture antigen prepared at the Haffkine Institute, Mumbai. A virulent strain of *Y. pestis* is cultured in casein hydrolysate broth for 2–4 weeks at 32°C, followed by inactivation with 0.05% formaldehyde and preservation in phenyl mercuric nitrate. The vaccine contains 2000 millions of plague bacilli/mL. A series of three injections of 0.5 mL of vaccine is given subcutaneously. Two doses are given at an interval of 1–3 months, followed by a third dose at the sixth month. The vaccine confers protection only for 6 months against bubonic plague. The vaccine is recommended for:

- Laboratory and field workers who come in contact with the plague bacillus or
- Individuals residing in endemic areas who cannot avoid exposure to rodents or fleas.

The vaccine is not effective against the pneumonic plague.

### ► Prophylactic antibiotic therapy

Prophylactic antibiotic therapy includes prophylaxis with tetracycline or streptomycin. Trimethoprim–sulfamethoxazole has also been effective for prophylaxis. Prophylactic antibiotic therapy is recommended for:

- Contacts of pneumonic plague victims.
- People who have been exposed to the bites of rodent fleas during a plague outbreak.
- Persons who have handled an animal known to be infected with the plague bacilli.

Antibiotic prophylaxis is not recommended for contacts with bubonic or septicemic plague.

### ► Environmental sanitation

Identifying the source of infection is the key component in preventing outbreaks of plague. Rodent control forms the mainstay of prevention of plague in urban area. Trained professionals should apply chemicals to kill fleas and rodents. Education of public in rural plague-endemic areas to avoid handling sick or dead rats and to avoid places where wild animals live is important.

### *Yersinia enterocolitica*

*Y. enterocolitica* is a well-recognized enteric bacterium that causes distinctive clinical manifestations, ranging from asymptomatic infections to life-threatening sepsis, especially in children. Schleifstein and Coleman were first to describe *Y. enterocolitica* in 1939. *Y. enterocolitica* is a Gram-negative coccobacillus that is motile at 22°C but not at 37°C. This bacillus resembles *Y. pseudotuberculosis* in being motile at 22°C, but differs from it in fermenting sucrose and cellobiose and decarboxylating ornithine. Many strains of *Y. enterocolitica* are VP and indole positive. They do not ferment rhamnose or melibiose. They are oxidase negative and nonlactose fermenting.

*Y. enterocolitica* are aerobes and grow at an optimum temperature of 22–29°C. *Y. enterocolitica* grows well at a pH of 5–9; hence the increased incidence of *Y. enterocolitica* infection is seen in patients who take antacids and H<sub>2</sub> blockers. The bacteria require iron to survive; hence *Yersinia* sepsis has been reported in children following accidental iron overdose and in hemochromatosis, clinical states of iron overload.

They grow well on commonly used basic enteric media. On MacConkey agar, they produce pinpoint colorless colonies after 24 hours of incubation. On blood agar, they form nonhemolytic smooth and translucent colonies measuring 2–3 mm in diameter after 2 days of incubation at 22°C. Cefsulodin-irgasan-novobiocin (CIN) agar is a frequently used selective medium for *Y. enterocolitica*.

The antigenic structure of *Y. enterocolitica* is distinct. *Y. enterocolitica* possesses 34 different O antigen factors and 19 H factors. On the basis of these antigens, more than 60 O serotypes have been reported. Most human isolates belong to serotypes O:3, O:5, 27; O:8 and represent the most virulent worldwide causes of human yersiniosis.

Virulence of *Y. enterocolitica* is chromosomal or plasmid mediated.

Humans acquire infection by ingestion of food or water contaminated with the bacteria. On ingestion, the bacteria adhere to the mucosa of terminal ileum, penetrate, and multiply in Peyer patches. The bacteria induce an inflammatory infiltrate in the lamina propria. The outer membrane protein is an important virulence factor that mediates adherence and invasion of the organism.

The bacteria may then spread to the mesenteric lymph nodes and may cause bacteremia, or form abscesses and pain in the right lower quadrant that simulate appendicitis. Although *Y. enterocolitica* produce a heat-stable enterotoxin similar to that of *Escherichia coli*, the enterotoxin does not contribute to the pathogenesis of the disease.

*Y. enterocolitica* causes enterocolitis primarily in young children, pseudoappendicitis syndrome, and extraintestinal infections.

- Enterocolitis is the most common clinical form of the disease, which occurs primarily in young children, with a mean age of 24 months. The incubation period is short, varies from 4 to 6 days. The condition manifests as watery, mucoid diarrhea in majority of patients; fever, colicky abdominal pain, bloody stools; and leukocytes in the stool. Diarrhea usually lasts from 1 day to 3 weeks. Most cases are self-limited.
- *Y. enterocolitica* infection causes mesenteric lymphadenitis with terminal ileitis. The condition, known as pseudoappendicitis syndrome, is more common in older children and young adults, and mimics appendicitis. It is characterized by fever, abdominal pain, tenderness in the right lower quadrant, and leukocytosis. The pseudoappendicitis syndrome is also caused by infection with *Y. pseudotuberculosis*.

- Extraintestinal infections, such as cellulitis, conjunctivitis, meningitis, osteomyelitis, pharyngitis, pneumonia, and urinary tract infection caused by *Y. pseudotuberculosis* are rare.

Laboratory diagnosis is made by isolation of *Y. enterocolitica* from stool by culture. Stool culture is positive within 2 weeks of onset of disease. Tube agglutination, ELISA, and radioimmunoassays are frequently used tests to detect antibodies in sera for diagnosis of the condition. Antibody titers rise 1 week after onset of illness and reach maximal levels at 2 weeks; raised antibody levels can be found for years after infection. Antibody titers more than 1:128 are suggestive of a previous infection with *Y. enterocolitica*.

Good nutrition and hydration are the mainstays of treatment. The role of antibiotic therapy in uncomplicated acute colitis and mesenteric adenitis is not established. Antibiotic therapy is indicated only for patients (a) with septicemia, (b) with focal extraintestinal manifestations, and (c) with enterocolitis who are immunocompromised. Tetracycline, aminoglycosides, and trimethoprim-sulfamethoxazole are the antibiotics of choice.

### ***Yersinia pseudotuberculosis***

*Y. pseudotuberculosis* is the least common of the three main *Yersinia* species to cause human infections. The bacillus was first described in 1889; first it was named as *Pasteurella* and then *Shigella pseudotuberculosis*. In 1960s, it was given the current name *Y. pseudotuberculosis*. Znamenskiy, a Russian worker, demonstrated the pathogenicity of the bacteria through self-inoculation.

*Y. pseudotuberculosis* is a small, ovoid, and bipolar stained Gram-negative bacillus. It is nonsporing, noncapsulated, and slightly acid fast. It is motile at 22°C but not at 37°C. The bacterium is oxidase negative, catalase positive, and urease positive. It is non-lactose-fermenting coccobacillus that is differentiated from other species, such as *Y. enterocolitica*, by its fermentation of sorbitol, ornithine decarboxylase activity, and other tests (Table 34-4).

TABLE 34-4

Differentiating features of *Yersinia* species

Properties	<i>Yersinia pestis</i>	<i>Yersinia pseudotuberculosis</i>	<i>Yersinia enterocolitica</i>
Growth on MacConkey agar	+	+	+
Motility at 22°C	–	+	+
Oxidase test	–	–	+
Urease test	–	+	+
Indole test	+	–	+
Acid from sucrose	+	–	+
Acid from maltose	–	+	+
Acid from rhamnose	–	+	–
Acid from melibiose	–	+	–
Ornithine decarboxylase test	–	–	+

*Y. pseudotuberculosis* is both aerobic and facultatively anaerobic; and optimum growth occurs on MacConkey or eosin-methylene blue (EMB) agar medium at 20–35°C. The growth of the bacteria is enhanced noticeably at lower temperatures (e.g., 4°C cold enrichment in buffered saline). The bacteria grow slowly on blood and chocolate agar plates, forming small colonies, gray and translucent colonies, at 24–72 hours of incubation.

*Y. pseudotuberculosis* has been classified into 6 serotypes (I–VI) and a number of subtypes, of which the O group, types I and II, are mainly responsible for human diseases. Approximately, 80% of human diseases are caused by type I serotypes. The bacteria show antigenic cross-reactivity with *Y. pestis* as well as salmonellae.

*Y. pseudotuberculosis* in experimentally infected guinea pigs produces multiple nodules in the lungs, spleen, and liver, resembling tuberculous lesions, hence named pseudotuberculosis.

Humans acquire infections primarily through the ingestion of contaminated food products. An inoculum of 10<sup>9</sup> organisms is the infective dose. *Y. pseudotuberculosis* causes a variety of clinical diseases, such as mesenteric lymphadenitis, granulomatous disease, and dissemination with sepsis. Patients with advanced liver disease and evidence of cirrhosis are more likely to develop a septic disease.

*Y. pseudotuberculosis* primarily causes gastroenteritis. The incubation period varies from 5 to 10 days. Gastroenteritis is characterized by a self-limited mesenteric lymphadenitis simulating acute appendicitis. Fever, abdominal pain (often right lower quadrant location), and rash are a major triad of *Y. pseudotuberculosis* infection. Diarrhea is not common. Erythema nodosum and reactive arthritis are the noted late complications of the infection.

- **Izumi fever**, a syndrome, is caused by *Y. pseudotuberculosis*. The condition is characterized by scarlatiniform rash, systemic symptoms, and coronary artery aneurysms.
- The **Far East scarlatinoid fever** is another syndrome caused by the bacteria. Presence of a scarlatinoid-appearing rash on the head and neck, erythema on the upper and lower extremity, mucous membrane enanthem, and strawberry tongue are characteristic features of the syndrome.

Erythema nodosum, arthralgias, reactive arthritis, and ankylosing spondylitis and terminal ileitis and intussusceptions, especially in children, are the other clinical manifestations of *Y. pseudotuberculosis* infection.

*Y. pseudotuberculosis* infection is distributed worldwide. Most cases occur in winter months, because a cold temperature favors the growth and multiplication of the bacteria. Most cases have been reported in Europe. Nevertheless, large-scale outbreaks have also been documented in the Aomori region of Japan in the early 1990s, and in children consuming untreated drinking water in Okayama, Japan, in 1991. Cases of septicemia are less; less than 30 cases of septicemia have been reported in the world literature.

*Y. pseudotuberculosis* is primarily a zoonotic infection. The animal reservoirs include many mammalian and avian hosts, such as horses, cattle, dogs, deer, cats, rabbits, rodents, and birds (e.g., geese, turkey, ducks, canaries, cockatoos). Butchers working in abattoirs slaughtering swine are at an increased risk to *Y. pseudotuberculosis* infection.

The laboratory diagnosis of *Y. pseudotuberculosis* infection is made by the following methods:

- Isolation of the bacteria by culture from stool, blood, CSF, peritoneal fluid, synovial fluid, or other organ-based biopsy (e.g., intestinal tissue, skin).
  - Isolation of bacteria from stool is difficult, given the slow growth pattern and overgrowth of normal fecal flora. However, stool culture may be facilitated by cold enrichment, using special culture media, such as CIN agar, or by alkali treatment.
- Histological examination of specific tissue, such as mesenteric lymph nodes, may show both pathologic and microbiologic presence of organism.
- ELISA and agglutination tests are employed for demonstration of serum antibodies, which may appear soon after the onset of illness but decrease over a period of 2–6 months. A rise in agglutinating antibodies in paired serum samples, collected after 2 weeks, is suggestive of the diagnosis. However, the test shows false positive reactions in sera from patients infected with *Yersinia*, *Vibrio*, *Salmonella*, *Brucella*, and *Rickettsia* species due to the presence of cross-reactive antibodies.

Antibiotic therapy is indicated only for younger patients with critical illness, and in the immunocompromised patients. Tetracycline, aminopenicillins, and aminoglycosides are the antibiotics frequently used for treatment of the condition.



## CASE STUDY

A 35-year-old man was admitted to the hospital with a sudden onset of high fever, chills, and headache, and also body aches, extreme exhaustion, abdominal pain, and diarrhea. Physical examination revealed the presence of painful, swollen lymph glands in the groin. Aspirate from the bubo on Gram staining showed pleomorphic Gram-negative coccobacilli. *Y. pestis* was isolated from the specimen by culture. The case was diagnosed to be bubonic plague.

- What is the other rapid method for demonstration of *Y. pestis* in bubonic aspirate?
- What are the serological tests available for diagnosis of the condition?
- What is the biotype of *Y. pestis* found in India?
- What are the foci of *Y. pestis* infection in India?
- What is the vaccine available for prevention of plague? Describe the vaccines available against the disease.

# *Vibrio*, *Aeromonas*, and *Plesiomonas*

## Introduction

Members of the family Vibrionaceae are aerobes and facultative anaerobes, nonsporing, catalase and oxidase positive. They reduce nitrates to nitrites and can grow on ordinary media. The family Vibrionaceae includes the genera *Vibrio*, *Plesiomonas*, and *Aeromonas*.

*Vibrio* species are oxidase-positive, Gram-negative curved bacilli that are motile by presence of polar flagellum. The name “vibrio” is derived from the characteristic vibratory motility (from *vibrare*, meaning to vibrate). They are asporogenous and noncapsulated. Vibrios are natural inhabitants of sea water but are also found in fresh water worldwide.

The genus *Vibrio* consists of at least 33 species of curved bacilli, of which 12 species have been implicated in human infections. *Vibrio cholerae*, *Vibrio parahaemolyticus*, and *Vibrio vulnificus* are the most prominent species causing human infections (Table 35-1).

## *Vibrio cholerae*

*V. cholerae* is the most important species that causes cholera, the most feared epidemic diarrheal disease. Dehydration and death can occur rapidly within a matter of hours of infection.

## Properties of the Bacteria

### ► Morphology

*V. cholerae* shows following features:

- *V. cholerae* are Gram-negative bacilli with rounded or slightly pointed ends. They measure 1–3  $\mu\text{m}$  in length and 0.5–0.8  $\mu\text{m}$  in diameter.

TABLE 35-1

### Human infections caused by *Vibrio* species

Bacteria	Diseases
<i>Vibrio cholerae</i>	Diarrhea
<i>Vibrio parahaemolyticus</i>	Gastroenteritis and wound infections
<i>Vibrio vulnificus</i>	Gastroenteritis and wound infections
<i>Vibrio hollisae</i>	Gastroenteritis and wound infections
<i>Vibrio mimicus</i>	Gastroenteritis and wound infections
<i>Vibrio metschnikovii</i>	Bacteremia
<i>Vibrio alginolyticus</i>	Wound infections and otitis externa

- The bacteria are typically comma shaped (Fig. 35-1). S-shaped or spiral forms may be seen due to two or more cells lying end to end.
- They are frequently pleomorphic in old cultures. In a stained film of mucous flakes from a case of cholera, the vibrios are typically arranged in parallel rows, described by Koch as the “fish in stream” appearance.
- They are actively motile by the presence of a single polar flagellum. They show typical darting type motility and appear as a “swarm of gnats” when examined under the microscope.
- It is nonsporing, noncapsulated, and nonacid fast.

### ► Culture

*V. cholerae* is strongly aerobic and grows best under aerobic conditions, whereas growth is scanty and slow under anaerobic conditions. It grows within a temperature range of 16–40°C (optimum 37°C).

It grows better in an alkaline medium, the range of pH being 7.4–9.6 (optimum 8.2). Sodium chloride (0.5–1%) is required for optimal growth, though high concentrations (5% and above) are inhibitory for growth of the bacteria. Unlike other halophilic bacteria, *V. cholerae* can grow in the absence of salt.

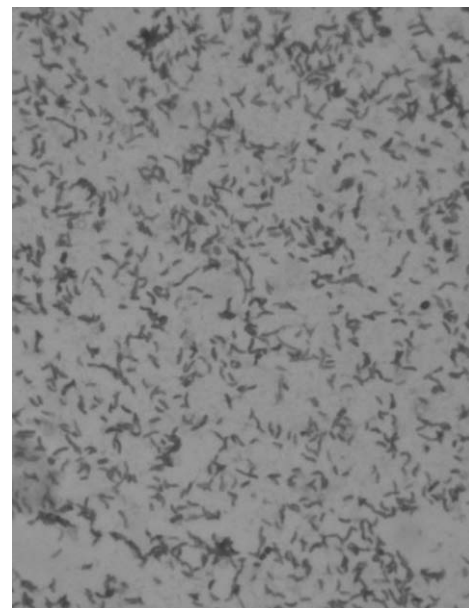

FIG. 35-1. Comma-shaped *Vibrio cholerae* in Gram-stained smear ( $\times 1000$ ).

*V. cholerae* grows well on a wide variety of media including nonselective media (e.g., nutrient agar, MacConkey agar, blood agar, gelatin agar, and peptone water) and special media (transport media, enrichment media, and selective media).

**1. Nonselective media:** *On nutrient agar*, *V. cholerae* after overnight incubation produces moist, translucent colonies with a bluish or greenish tinge. The colonies measure about 1–2 mm in diameter. The colonies emit a distinctive odor. The colonies *on MacConkey agar* are initially colorless after overnight incubation, but become reddish on prolonged incubation due to the late fermentation of lactose. *On blood agar*, *V. cholerae* biotype Eltor produces hemolytic colonies. Biotype Classical strains, however, produce greenish discoloration around the colonies, which later becomes clear due to hemodigestion. *In gelatin stab culture*, *V. cholerae* produces infundibuliform (*funnel-shaped*) or napiform (*turnip-shaped*) liquefaction after 3 days of incubation at 22°C. *In peptone water*, growth of bacteria forms a fine surface pellicle in about 6–9 hours of incubation.

**2. Transport media:** Transport media are used to transport stool samples in case of delay in processing the specimens in laboratory. These help in maintaining viability of *V. cholerae* and prevent the bacteria from being inhibited by normal intestinal bacterial flora present in stool specimens. Venkatraman–Ramakrishnan (VR) medium and Cary–Blair medium are two frequently used transport media.

- **VR medium:** This is a simple liquid medium prepared by dissolving 20 g crude sea salt and 5 g peptone in 1L of distilled water. It is an alkaline medium with a pH of 8.6–8.8. The medium is dispensed in screw-capped bottles in volumes of 10–15 mL amounts. About 1–3 mL stool is to be added to each bottle.
- **Cary–Blair medium:** This is a solid medium. It consists of buffered solution of sodium chloride, sodium thioglycollate, disodium hydrogen phosphate, calcium chloride, and agar with an alkaline pH of 8. It is a suitable transport medium for *Vibrio* spp. as well as for *Salmonella* and *Shigella* spp.

**3. Enrichment media:** The enrichment media for *V. cholerae* are liquid media with a high pH. The high pH of the media suppresses growth of many commensal intestinal bacteria but favors the growth of *V. cholerae*. Alkaline peptone water (APW) and Monsur's taurocholate tellurite peptone water are two examples of transport media used for *V. cholerae*.

- **APW:** It is a frequently used medium for enrichment of stool specimens from patients convalescing from cholera, excreting few bacteria in their stool. The pH of APW is 8.6. Nearly 1 g of stool or rectal swab is inoculated into 10 mL of APW in a screw-capped tube and is transported to the laboratory. The APW is incubated at 37°C for 3–6 hours, and afterwards the subculture is made on the selective media.
- **Monsur's taurocholate tellurite peptone water:** Potassium tellurite solution is added to the medium to make it more selective for *V. cholerae*. pH of the medium is 9.0. Stool or rectal swab is inoculated into the medium and incubated at 37°C for 3–6 hours, and afterwards the subculture is made on the selective media.

**4. Selective media:** These media are useful for isolation of *V. cholerae* and other vibrios from feces. These include (a) thiosulfate citrate bile salt sucrose (TCBS) medium, (b) Monsur's gelatin taurocholate trypticase tellurite agar (GTTA) medium, and (c) alkaline bile salt agar (BSA). All these media characteristically have a high pH, which suppresses growth of other intestinal bacteria but favors growth of vibrios.

- **TCBS medium (pH 8.6):** This medium contains thiosulfate, citrate, bile salts, sucrose, and bromothymol blue (indicator). *V. cholerae* produces large, yellow convex colonies on this medium (Color Photo 35). This is due to fermentation of sucrose by the bacteria, leading to production of acid. Accumulation of acid reduces pH of the medium, and so the color of the bromothymol blue indicator becomes yellow, thus making *V. cholerae* colonies yellow. Nonsucrose-fermenting *V. parahaemolyticus* produces blue green colonies.
- **Monsur's GTTA medium (pH 8.5):** High pH of the medium and presence of potassium tellurite in this medium inhibits most of Gram-positive bacteria and enteric bacteria with exception of *Proteus* species. Hence, the GTTA medium is used for isolation of *V. cholerae* and other vibrios from feces. *V. cholerae* produces small, translucent colonies with grayish black center and a turbid halo after 24 hours of incubation. The colonies become larger (3–4 mm in size) after a prolonged incubation of 48 hours.
- **Alkaline BSA (pH 8.2):** This is another selective medium used for *V. cholerae*. The colonies on BSA are similar to those on nutrient agar.

## ► Biochemical reactions

*V. cholerae* shows following features:

- It is catalase positive and oxidase positive.
- *V. cholerae* ferments sugars with production of acid only (no gas). It ferments glucose, sucrose, maltose, mannitol, and mannose. It is a late lactose fermenter ferments lactose on incubation for several days.
- It does not ferment arabinose, inositol, and dulcitol.
- It forms indole and reduces nitrates to nitrites.
- *V. cholerae* shows positive cholera red reaction by producing a reddish pink color in the peptone water due to formation of nitroso indole. The two properties of formation of indole and reduction of nitrates to nitrites form the basis of cholera red reaction. This reaction is tested by adding a few drops of concentrated sulfuric acid to a 24-hour peptone water culture at 37°C.
- It is methyl red positive and urease test negative.
- It liquefies gelatin and decarboxylates lysine and ornithine, but not arginine.

*V. cholerae* biotypes Classical and Eltor show variable Voges–Proskauer reaction, hemolysis of sheep RBCs, and hemagglutination of chick RBCs. The differences between Classical and Eltor biotypes of *V. cholerae* are summarized in Table 35-2.

TABLE 35-2

**Differential characteristics of *Vibrio cholerae* biotypes**

Properties	<i>Vibrio cholerae</i> biotype	
	Classical	Eltor
Hemolysis of sheep RBCs	–	+
Agglutination of chick erythrocytes	–	+
Voges-Proskauer test	–	+
Polymixin B sensitivity	+	–
<b>Susceptibility to</b>		
Mukerjee Group IV Phage	+	–
Eltor phage 5	–	+
Vibriostatic (O/129) agent	+	–

**Other properties**

**Susceptibility to physical and chemical agents:** *V. cholerae* is most susceptible to heat, drying, acids, and common disinfectants. *V. cholerae* are killed by heating at 56°C for 30 minutes, killed in a few minutes in gastric juice of normal acidity. They are resistant to high alkalinity. They remain viable for 1–2 weeks in fresh sea water. They survive in pure tap water for up to 30 days. On fruits, they survive for 1–5 days at room temperature and for a week in the refrigerator. However, vibrios do not survive longer in grossly contaminated water, such as river Ganga water in India—most possible due to the presence of large number of bacteriophages in this water. They survive for several days in untreated excreta of humans.

**Cell Wall Components and Antigenic Structure**

*V. cholerae* like that of Gram-negative bacilli also possesses the lipopolysaccharide (LPS). The LPS has no role in the pathogenesis of cholera but is responsible for the immunity produced by killed *V. cholerae* vaccine. *V. cholerae* possesses two antigens:

- Somatic O antigen is present in the cell wall of the bacteria. It is a group-specific antigen.
- Flagellar H antigen is a heat-labile antigen present in the flagella and is shared by all strains of *V. cholerae*.

**Serological classification**

*V. cholerae* has been classified according to somatic carbohydrate O antigen into many serotypes. This serological classification was suggested by Gardner and Venkatraman (1935). More than 200 serotypes have been described, which have been classified broadly into two groups—*V. cholerae* O1 and non-O1 *V. cholerae*:

- *V. cholerae* O1 agglutinate with antisera to the O1 group and are called cholera vibrios or agglutinable vibrios. *V. cholerae* O1 is subdivided into two biotypes—Eltor and Classical, on the basis of their biochemical parameters. Each biotype has been divided further into three subtypes—Ogawa, Inaba, and Hikojima (Table 35-3). This classification is based on the differences in minor O antigens, such as A, B, C. Serotype

TABLE 35-3

**Serotypes of *Vibrio cholerae* O1**

Serotype	O antigens
Ogawa	AB
Inaba	AC
Hikojima	ABC

Ogawa contains A and B antigens, Inaba contains A and C antigens, and Hikojima contains all three antigens A, B, and C. Hence, Hikojima strains are agglutinated by both Ogawa and Inaba antisera, whereas Ogawa and Inaba strains are agglutinated by their own specific antisera only.

- Non-O1 *V. cholerae*, which do not agglutinate with O1 group antisera, are designated as noncholera vibrios or nonagglutinating vibrios (Fig. 35-2). Noncholera vibrios are classified into 138 serotypes designated from O2 to O139. Of these serotypes, only *V. cholerae* O139 causes cholera in humans. Rest of the serotypes (O2–O138) do not cause any disease in humans.

**Phage typing**

*V. cholerae* O1 biotype Classical has been divided into five types on the basis of four phages (I, II, III, and IV). All these phages lyse biotype Classical but not Eltor strains. On the basis of these four phages and an additional fifth phage, *V. cholerae* biotype Eltor can also be divided into six types.

**Biotyping**

On the basis of fermentation of mannose, sucrose, and arabinose, Vibrios have been classified by Heiberg (1934) into six groups (I, II, III, IV, V, and VI); subsequently, two more groups have been added. *V. cholerae* belongs to group I.

**Pathogenesis and Immunity**

Cholera is a toxin-mediated disease. Cholera toxin (CTx) produced by *V. cholerae* is the key virulence factor of the bacteria.

**Virulence factors**

Virulence factors of *V. cholerae* include (i) cholera toxin, (ii) toxin coregulated pilus (TCP), (iii) adhesin factor (ACF), (iv) hemagglutination-protease (hap; mucinase), (v) neuraminidase, and (vi) siderophores (Table 35-4). Most of these virulence factors are expressed by multiple chromosomal genes present

**Key Points****Cholera toxin**

An exotoxin and the most important virulence factor produced by *V. cholerae*.

- Also known as cholera toxin or cholera enterotoxin; it is structurally and functionally similar to the heat-labile enterotoxin of *Escherichia coli*. It is a heat-labile protein of



molecular weight 85,600 kDa, and is destroyed by heating at 56°C for 30 minutes.

- Contains two subunits—A and B. The genes CTx A and CTx B are responsible for expression of these two subunits of cholera toxin.
- Consists of a single A subunit of molecular weight 27,215 kDa and five B subunits each of molecular weight 11,677 kDa.
- The A (active) subunit is responsible for the biological activity of the toxin. Subunit A consists of two fragments—A1 and A2, which remain covalently connected by a single disulfide bond. The A2 fragment is responsible for linking active A fragment to the B subunit.

in *V. cholerae*. These genes include the genes for cholera toxin (CTx A and CTx B), TCP, ACF, hap, and neuraminidase.

A1 fragment is responsible for the biological activity of the toxin. The A1 subunit stimulates cell-bound cyclic adenosine monophosphate (cAMP), which in turn converts ATP to cAMP in the intestines of epithelial cells of the gut. Cholera toxin has the following biological functions:

- This inhibits the absorption capacity and activates the excretory chloride transport in the intestinal enterocytes, eventually leading to loss of sodium chloride in the intestinal lumen. The osmolality in the intestinal lumen is balanced by secretion of large quantities of water, which eventually overcomes the absorptive capacity and leads to diarrhea. The diarrheic fluid is isotonic in nature but contains much more of potassium and bicarbonate.
- It also inhibits absorption of sodium and chloride in the intestine.

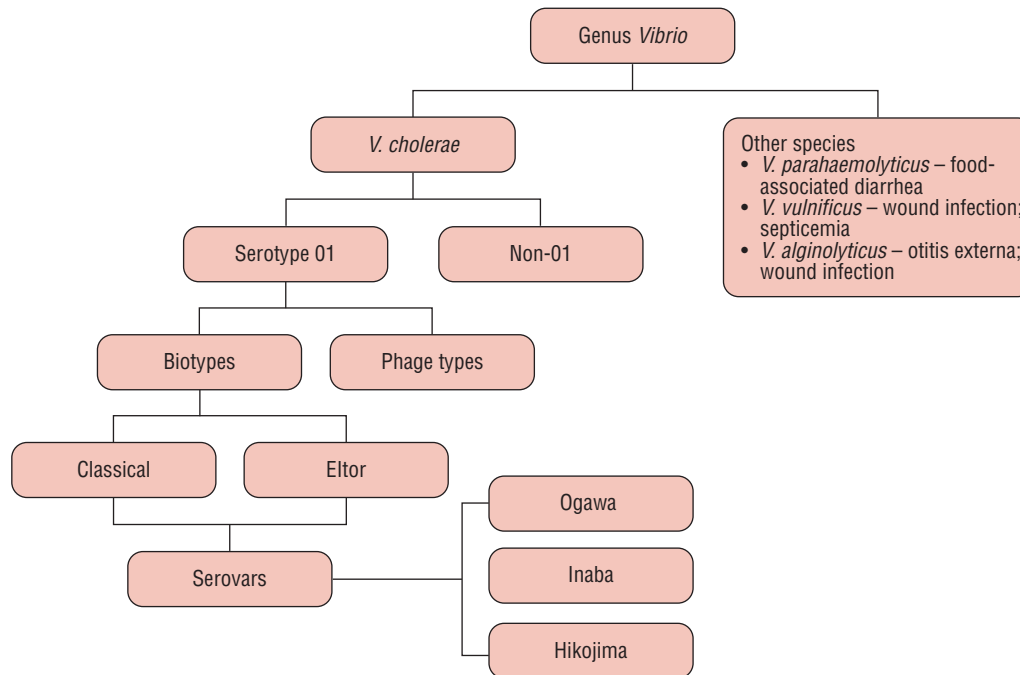

FIG. 35-2. A schematic diagram showing classification of the genus *Vibrio*.

TABLE 35-4

Virulence factors of *Vibrio cholerae*

Virulence factors	Biological functions
Cholera toxin	The toxin inhibits absorption of sodium and chloride in the intestine; causes hypersecretion of large volumes of water and electrolytes. Activation of adenylate cyclase and overproduction of cAMP.
Toxin coregulated pilus	Helps in adherence of <i>Vibrio cholerae</i> to mucosal cells of the intestine
Accessory colonization	Helps in adhesion of bacteria to the intestinal mucosa
Hemagglutination-protease (mucinase)	Induces intestinal inflammation and also helps in releasing free vibrios from the bound mucosa to the intestinal lumen
Neuraminidase	Increases toxin receptors for <i>Vibrio cholerae</i>
Siderophores	Causes sequestration of iron

■ It also increases skin capillary permeability. Hence, it is also called as a permeability factor. The permeability factor can be detected by skin bluing test. In this test, cholera toxin is injected intradermally in rabbits or guinea pigs, followed by intravenous injection of Evans blue. In a positive test, the skin at the site of injection becomes blue due to increased capillary permeability.

The cholera toxin can be demonstrated by the following tests:

1. Rabbit ileal loop test was one of the classical methods developed by De and Chatterjee in 1952. It is a widely used method in which injection of *V. cholerae* culture or culture filtrate into the ligated ileal loop causes accumulation of fluid, leading to ballooning of the ileal loop.
2. ELISA and RIF (rapid immunofluorescence) tests.
3. Chemical estimation of cAMP in tumor cells that have been treated with the toxin.
4. Demonstration of histological changes in adrenal tumor (Y1) cells, elongation of Chinese hamster ovary cells, and activation of lipolysis in rat testicular tissue.

**Toxin coregulated pilus:** The pili help in adherence of *V. cholerae* to mucosal cells of the intestines.

**Accessory colonization:** These also help in adhesion of bacteria to the intestinal mucosa.

**Hemagglutination-protease (mucinase):** This enzyme, formerly known as cholera lectin, is both agglutinin- and zinc-dependent protease. The enzyme splits mucin and fibronectin as well as subunit of the cholera toxin. It induces intestinal inflammation and also helps in releasing free vibrios from the bound mucosa to the intestinal lumen.

**Neuraminidase:** The enzyme destroys neuraminic acid, thereby increasing toxin receptors for the *V. cholerae*.

**Siderophores:** It is responsible for sequestration of iron.

## ► Pathogenesis of Cholera

*V. cholerae* usually enters the body orally through contaminated water and food (Fig. 35-3). Gastric acidity is the first line of defense against infection caused by *V. cholerae*, because vibrios are highly susceptible to the acidity of stomach. The conditions that reduce acidity of the stomach to pH above 5 make the host more susceptible to infection by cholera vibrios.

On reaching the small intestine by using its own mechanisms, such as motility, chemokines, and production of enzymes (hemagglutinin and protease), *V. cholerae* reaches the mucous layer of the small intestine. Hemagglutinin and protease break mucin and fibronectin of the mucosa. Subsequently, bacteria adhere to the intestinal wall facilitated by TCP. This synchronous action of CTx, TCP, and a few other virulence factors is regulated by Tox R gene products, which is known as the *master switch*.

Vibrios, once adhered to the intestinal wall, produce cholera toxin. The toxin activates cAMP, which inhibits the absorption

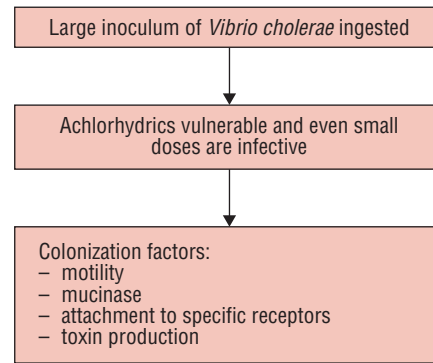

FIG. 35-3. Colonization of *Vibrio cholerae* in the intestine.

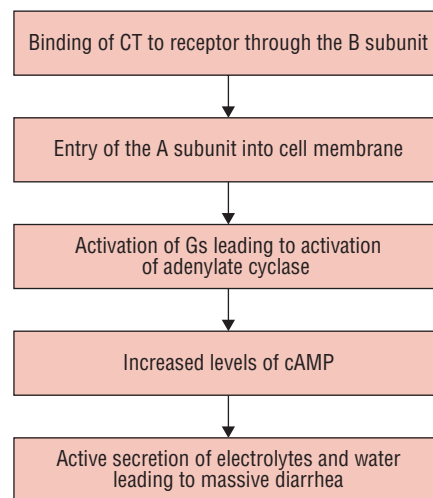

FIG. 35-4. Pathogenesis of diarrhea caused by cholera toxin.

of sodium transport and activates the excretory chloride transport in the intestinal epithelial cells. This leads to an accumulation of sodium chloride in the lumen of intestine. The high osmolarity of the intestinal fluid is balanced by large secretion of water, which overcomes the absorptive capacity of the lumen, eventually causing diarrhea (Fig. 35-4).

*V. cholerae* O139 strain shows a similar pathogenic mechanism to that of *V. cholerae* O1 except that it produces a unique O139 LPS and an immunologically related O antigen capsule. These two virulence factors enhance virulence of this organism. These are also responsible for increase in its resistance to human serum *in vitro* and development of bacteremia occasionally seen during the infection caused by the bacteria.

## ► Host immunity

Immunity in cholera may be produced against the cholera toxin or against the bacteria. Natural infections in cholera induce some degree of immunity for a short duration of 6–12 months. Reinfection occurs in the same person after this period. Vaccination with killed cholera vaccine confers a short-lived

protection. Live oral vaccines induce local immunity by production of IgA antibodies in the gut. The immunity induced by these oral vaccines is also short lived. An infection by *V. cholerae* biotype Classical usually protects against the infection caused by *V. cholerae* biotype Classical as well as Eltor strains. But infection by *V. cholerae* biotype Eltor does not confer protection against biotype Classical.

## Clinical Syndromes

*V. cholerae* causes cholera (an acute diarrheal disease), which may be rapidly fatal, if not treated immediately.

### ► Cholera

The incubation period is short and varies from 2 to 3 days after ingestion of the bacteria. The condition shows an abrupt onset of watery diarrhea and vomiting. Profuse watery diarrhea is the most important manifestation of cholera. The volume of diarrheic stool excreted in cholera is much more than that of diarrhea caused by any other infectious pathogen. In a severe condition, patients may excrete as high as 250 mL of stool per kg body weight in a day. The cholera stool:

- is profusely watery that is colorless and odorless, free of proteins and speckled with mucous and often is described as rice water stool (in color and consistency, stool resembles water that has been washed off from cooked rice);
- contains few leukocytes, but no erythrocytes because *V. cholerae* does not stimulate any inflammatory response in the intestinal mucosa; and
- is a bicarbonate-rich electrolyte fluid, which contains little protein.

Severe abdominal cramp, possibly caused by distension of the small intestine due to excretion of larger volumes of intestinal fluid, is also seen in these patients. Vomiting is another important manifestation of cholera and occurs in early stage of the disease. This is caused by decreased gastric and intestinal motility.

Cholera if left untreated can lead to severe loss of fluid and electrolytes due to diarrhea and vomiting. This could lead to isotonic dehydration, metabolic acidosis, hypokalemia, and hypovolemic shock.

Dehydration in cholera characteristically develops very fast, within hours after the onset of symptoms. This rapid development of dehydration is not seen with diarrheal diseases caused by any other enteropathogen. In patients with severe disease, diarrhea leads to vascular prolapse and shock, and patients may die of cardiac arrhythmia and renal failure. Other complications include electrolyte imbalance and hypoglycemia.

In untreated patients, case fatality rate has been estimated to vary from 25% to 50%. In patients treated well with replacement of lost fluid and electrolytes, the case fatality is usually less than 1%.

*V. cholerae* O139 causes cholera, which can be as severe as that caused by *V. cholerae* O1. *V. cholerae* O139 may occasionally cause invasive disease producing bacteremia.

## Epidemiology

*V. cholerae* are found naturally in estuary and marine environment worldwide.

### ► Geographical distribution

Cholera continues to be a major health problem in many parts of the world including Indian subcontinent and sub-Saharan in Africa. The condition is rare in the developed and industrious nations for the last many decades. A large number of cases of cholera have been reported in the year 2004 from a total of 56 countries from different parts of the world. A total of 101,338 cases and 2345 deaths were reported from these countries. Majority of cases were reported from Africa and Asia. Cholera occurs as an endemic, epidemic, or a pandemic disease.

**Cholera pandemics:** A total of six pandemics of cholera occurred in the nineteenth century, affecting Europe and the United States, causing more than 115,000 deaths in 1832 and 50,000 deaths in 1856. The seventh pandemic of cholera appeared first in the twentieth century starting in 1961 and affected five continents by 1991. Unlike six earlier pandemics, which were caused by *V. cholerae* biotype Classical, the seventh pandemic was caused by *V. cholerae* biotype Eltor. The latter originated in Asia in the 1960s, reached Africa in the early 1970s, and was responsible for epidemic cholera. In 1991, the pandemic reached Peru and subsequently spread rapidly through many countries of South and Central America as well as in the United States and Canada. By mid-1995, more than 1 million cases and 10,000 deaths due to the disease were reported in the United States. The seventh pandemic of cholera was different from previous pandemics of cholera in the following ways:

1. It was the first pandemic to be originated from outside Indian subcontinent. It was originated from Sulawesi (Celebes), Indonesia. From here, it spread to Hong Kong and Philippines and entered India in 1964. By 1966, it entered and spread throughout the Indian subcontinent and West Asia. The pandemic then spread to Africa and parts of Southern Europe in 1970s.
2. It was the first pandemic to be caused by *V. cholerae* biotype Eltor in contrast to earlier six pandemics caused by *V. cholerae* biotype Classical.
3. *V. cholerae* biotype Eltor, responsible for seventh pandemic, caused a less severe illness with a large proportion of mild and asymptomatic infections. Mortality rate was low, but characteristically carrier rate was high.
4. *V. cholerae* biotype Eltor has nearly replaced the *V. cholerae* biotype Classical strain following this pandemic spread. Hence, in countries like India, *V. cholerae* Classical strains are rarely encountered, but in Bangladesh, there has been a resurgence of cholera caused by *V. cholerae* Classical strains.

In 1992, a new epidemic strain *V. cholerae* O139 has emerged as a cause of epidemic cholera in India. This new epidemic strain

was first reported from an outbreak of cholera in Chennai in the year 1992, followed by similar outbreaks of cholera from different parts of India. The new strain entered Bangladesh and spread across the country, causing epidemics of cholera by January 1993.

## Key Points

### *V. cholerae* O139

- The first noncholera *Vibrio* or noncholera strain that is associated with epidemics of cholera.
- Also responsible for producing disease in individuals previously infected with *V. cholerae* O1 strains.

## ► Habitat

*V. cholerae* is a salt water bacterium. Marine ecosystem in association with plankton is the primary habitat of the bacteria. The bacteria can multiply freely in the water. The number of bacteria in contaminated water increases during the warm and hot months of the year. *V. cholerae* is never found in normal humans. In infected humans, *V. cholerae* inhabits the small intestine.

## ► Reservoir, source, and transmission of the infection

Humans and water are the two main reservoirs of infection for cholera. Both chronic and convalescent carriers play an important role as reservoirs in the transmission of infection. These chronic carriers continue to excrete vibrios in their stool intermittently for several years.

Animals do not play any role in transmission of the disease. The infection is transmitted to humans by ingestion of contaminated food or water. Hence, the infection rate is highest in the areas where community hygienic standards are low and potable water is not available. The infective dose of *V. cholerae* is usually high, more than  $10^6$  organisms/mL, because most organisms are killed by high acidity in the stomach. *V. cholerae* fails to survive in acidic environment. Therefore, any condition (e.g., achlorhydria) that reduces production of gastric acid makes the person highly susceptible to infection. Transmission of infection by direct contact from person-to-person is rare. People of all ages are susceptible to infection by *V. cholerae*. Infants, however, are protected due to maternal antibodies transmitted during breast-feeding.

## Laboratory Diagnosis

### ► Specimens

Fresh stool specimen collected before administration of antibiotics is the specimen of choice. The stool may be collected by introducing a sterile soft rubber catheter (No: 24–26), or the liquid stool may be collected directly in a screw-capped container. Collection of stool from bed pan is not recommended due to the risk of contamination or the presence of disinfectants. Rectal swabs may also be used for collection

of specimens. They are particularly useful in collecting stool specimens from convalescent patients who no longer excrete watery stool. Vomitus is not a useful specimen. The collected stool or rectal swab specimen should be sent to laboratory for immediate culture:

- If delay is anticipated, the specimens may be preserved at 4°C in a refrigerator or in transport media used for *V. cholerae*.
- The specimen may be transported in enrichment media, such as alkaline peptone water or Monsur's taurocholate transport media and sent to laboratory for processing within few hours.
- In case of a longer delay in transport, the stool samples may be preserved in Cary–Blair medium or in VR fluid for long duration.
- In case of nonavailability of transport media, the watery stool can be soaked in a strip of thick blotting paper and sent to the laboratory—packed in a plastic envelope.

## ► Microscopy

Dark-field microscopy is a useful method for demonstrating characteristic motility of the bacilli and its inhibition by antisera. This is a rapid method of examination of stool collected from cases or after enrichment for 6 hours. Direct immunofluorescence is another rapid method used for demonstration of vibrios in the stool. However, microscopic examination of a Gram-stained stool smear is not recommended for diagnosis of cholera.

## ► Culture

The specimen collected in holding media is inoculated first in the enrichment media and incubated for 6–8 hours before being inoculated on selective (TCBS or GTTA) and nonselective media (BSA, MacConkey agar, and blood agar). The specimen may also be plated directly into these media before enrichment. The specimens collected in transport media are incubated for 6–8 hours including the transit time before inoculation into the suitable media. The inoculated plates are incubated at 37°C overnight. *V. cholerae* produces characteristic yellow colonies on TCBS and nonlactose-fermenting colonies on MacConkey agar.

## ► Identification of bacteria

Colonies on media are identified by performing a series of biochemical tests (Box 35-1). These include oxidase test (Fig. 35-5), utilization of amino acids, such as lysine, ornithine, and arginine (Color Photo 36); fermentation of sugars; sheep cell hemolysis; chick cell agglutination; VP test; polymyxin B sensitivity; etc. and serotyping using specific polyvalent antisera (Box 35-1).

**Serotyping:** Suspected *V. cholerae* are tested by slide agglutination, using specific *V. cholerae* O1 antisera. In this test, the colonies are picked up with a straight wire and mixed with a drop of antisera on the slide. Agglutination of the bacteria shows that the test is positive for *V. cholerae* O1. If positive, agglutination of bacteria is repeated using specific Inaba and Ogawa sera for serotyping. Hikojima strains agglutinate well with both Inaba and Ogawa sera. If agglutination is negative, the test is repeated

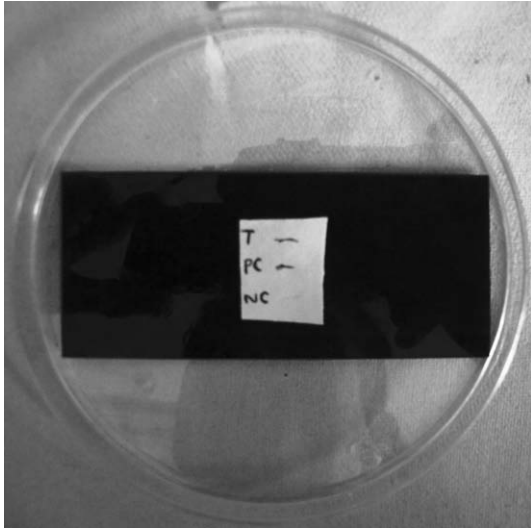

FIG. 35-5. Oxidase test.

### Box 35-1 Identifying features of *Vibrio cholerae*

1. Gram-stained smear shows typically comma-shaped Gram-negative bacilli with rounded or slightly pointed ends.
2. They show typical darting type motility.
3. The bacteria ferment sugars with production of acid only but no gas. They ferment glucose, sucrose, maltose, mannitol, and mannose.
4. The bacteria are positive for cholera red reaction, form indole, and reduce nitrates to nitrites.
5. The bacteria are catalase positive and oxidase positive.
6. *Vibrio cholerae* utilizes amino acids, such as lysine and ornithine, but does not utilize arginine.
7. Serotyping using specific polyvalent antisera—*Vibrio cholerae* O1 agglutinate with antisera to the O1 group and are called cholera vibrios or agglutinable vibrios.
8. Non-O1 *V. cholerae* do not agglutinate with O1 group antisera and are designated as noncholera vibrios or nonagglutinating vibrios.
9. *V. cholerae* O1 is identified as biotype Classical or Eltor depending on their biochemical reactions (Table 35-2).

with at least five more colonies, as both O1 and non-O1 vibrios may coexist in the same specimen.

**Biotyping:** If the slide agglutination is positive and the colony is identified as *V. cholerae* O1, then it is tested by various tests to determine whether isolated *V. cholerae* O1 is Classical or Eltor. These tests include hemolysis of sheep RBCs, agglutination of chick RBCs, sensitivity to polymyxin B, VP test, and sensitivity to bacteriophages (Table 35-2).

*Vibrio* colonies that are not agglutinated with *V. cholerae* O1 antisera are usually tested with antisera to the H antigen. *Vibrio* isolates that are agglutinated by H antisera but not by O1 antisera are identified as non-O1 cholera vibrio. Such noncholera vibrios are tested for O139 by using specific antisera against O139 antigen.

The isolated strains of *V. cholerae* O1 for phage typing may be sent to the international reference center for *Vibrio* phage typing at the National Institute of Cholera and Enteric Diseases (NICED) at Kolkata, West Bengal.

### ► Diagnosis of carriers

Repeated culture of stool is essential for isolation of *V. cholerae* from carriers because vibrios are known to be excreted intermittently in their stool. Collection of stool after using a purgative (such as mannitol or magnesium sulphate) or examination of bile collected by duodenal intubation are frequently useful for diagnosis of carriers.

### ► Serodiagnosis

The complement-dependent vibriocidal antibody assay and antitoxin assay using live or killed vibrio suspensions are useful for demonstration of vibrio antibodies in the serum. These tests are useful for seroepidemiological studies, but are of little value in the diagnosis of cases.

### Treatment

Treatment of cholera includes (a) replacement of fluid and electrolytes and (b) antibiotic therapy.

### ► Replacement of fluid and electrolytes

Treatment of cholera is primarily based on prompt and adequate replacement of fluid and electrolytes, before the resultant massive loss of fluid leads to hypovolemic shock. Replacement of fluid by oral administration of fluid containing glucose and electrolytes is the most successful and highly effective method for treatment of cholera. The oral rehydration therapy (ORT) solution consisting of glucose, sodium chloride, potassium chloride, and sodium citrate is widely used. The glucose facilitates absorption of sodium in the small intestine, and salts present in the ORT restore the electrolyte balance and thereby reverse acidosis.

The ORT is highly cost-effective and is simple to use; hence it is widely used with tremendous success in developing countries endemic for cholera. Cereal-based preparation, such as thoroughly cooked and salted rice soup, is also equally effective for treatment of dehydration in cases of cholera. Immediate intravenous fluid therapy is usually recommended for more serious cases of dehydration.

### ► Antibiotic therapy

Antibiotic therapy is of secondary importance and is a supplement to fluid therapy. Treatment with antibiotics diminishes the duration and volume of fluid loss. It also hastens clearance of the *Vibrio* organisms from the intestine. *V. cholerae* are uniformly sensitive to tetracycline, ciprofloxacin, and erythromycin. Tetracycline or doxycycline is the drug of choice for adults and trimethoprim-sulfamethoxazole for children. Pyrazolidone is the usually recommended treatment for pregnant females suffering from cholera. Of late, strains resistant to ciprofloxacin have been documented from Kolkata, India.

### Prevention and Control

The preventive measures against cholera include general preventive measures and cholera vaccination.

## ► General preventive measures

These include early identification and case management, improved water supply and sanitation, improved personal hygiene, and health education.

### Vaccines

**Killed cholera vaccines:** This is the traditional vaccine used against cholera. This vaccine is a suspension of 8000 million *V. cholerae* per mL, consisting of equal numbers of Inaba and Ogawa serotypes. This vaccine is given either subcutaneously or intramuscularly in two doses at an interval of 4 weeks. This vaccine confers about 60% protection for a short duration of 3–6 months. The rate of protection in endemic areas increases with age. A single dose of vaccine is not effective in children younger than 5 years but is effective in adults. In order to improve the antigenic stimulus, the number of organisms in the vaccine has been increased to 12,000 million/mL.

**Nonliving oral B subunit whole cell vaccine (WC/rBS vaccine):** WC/rBS vaccine is a nonliving oral B subunit whole cell vaccine. It consists of heat-killed whole cell *V. cholerae* O1 ( $2.5 \times 10^{10}$ ) in combination with the purified recombinant B subunit of cholera toxin (WC/rBS). This vaccine is administered in two doses at an interval of 1 week. This vaccine is currently available in Sweden and Latin America. Clinical trials carried out in Bangladesh, Peru, and Sweden have shown that vaccine is safe and confers 85–90% protection during 6 months in all age groups after administration of two doses.

**Live oral cholera vaccine (CVD 103-Hg R vaccine):** CVD 103-Hg R vaccine is an oral cholera vaccine. It consists of an attenuated live oral genetically modified *V. cholerae* O1 strain (CVD 103-Hg R). This cholera vaccine developed by the Swiss Sera and Vaccine Institute is available in Europe, Latin America, and Canada. The vaccine is extremely immunogenic and highly protective against moderate and severe cases of cholera. The vaccine trials in adult volunteers in the United States have shown that a single dose confers high protection (95%) against *V. cholerae* Classical and 65% protection against *V. cholerae* Eltor following a booster dose given after 3 months.

### Noncholera Vibrios

*V. cholerae* serotypes from O2 to O139 are known as noncholera vibrios, nonagglutinable vibrios, or *V. cholerae* non-O1 vibrios. They are similar to *V. cholerae* O1 biochemically and genetically. *V. cholerae* O139 is only example of noncholera vibrios that causes cholera as mentioned earlier. Noncholera vibrios other than *V. cholerae* O139 are widely found in the aquatic environments. In humans, they may cause mild to severe diarrheal disease resembling cholera. Occasionally, they may also cause wound infections, septicemia, and other extraintestinal infections.

### *Vibrio mimicus*

*V. mimicus* has been associated with many sporadic cases of diarrheal disease on the gulf coast of the United States.

*V. mimicus* is so named because it resembles *V. cholerae* in its biochemical reactions. *V. mimicus*, unlike *V. cholerae*, does not ferment sucrose, but like *V. cholerae* it grows well at a 0.5–1% concentrated sodium chloride. Infection is acquired by eating seafood, especially oysters. The organisms cause a gastrointestinal disease, which is usually self-limited.

### Halophilic Vibrios

Vibrios that require a higher concentration of sodium chloride are known as halophilic vibrios. They are natural inhabitants of sea water and marine life. *V. parahaemolyticus*, *Vibrio alginolyticus*, and *V. vulnificus* are three important halophilic vibrios species known to cause infection in humans.

### *Vibrio parahaemolyticus*

*V. parahaemolyticus* is now recognized as an important cause of seafood-associated gastroenteritis throughout the world. *V. parahaemolyticus* is a curved Gram-negative bacillus that resembles *V. cholerae*. However, it differs from *V. cholerae* by having a capsule showing bipolar staining and pleomorphism. It shows pleomorphism especially in cold cultures or when grown on 3% salt agar. Like other vibrios, it has polar flagella when grown in liquid culture, but shows peritrichous flagella when grown on solid media.

It has simple nutritional requirement, but requires salt for growth. The organism fails to grow in the medium in the absence of sodium chloride. It can grow well in salt concentration up to 8% and at an optimum salt concentration of 2–4%.

On MacConkey agar, it produces colorless nonlactose-fermenting colonies; on blood agar, it forms beta-hemolytic colonies. The colonies on TCBS agar are nonsucrose-fermenting green colonies with an opaque and raised center and translucent periphery.

*V. parahaemolyticus* is oxidase, catalase, indole, and citrate positive. It reduces nitrates to nitrites. It is a fermenter ferments glucose, mannose, maltose, mannitol, and arabinose with production of acid only. It does not ferment sucrose, lactose, and salicin. It decarboxylates lysine and ornithine but not arginine. It is VP positive.

*V. parahaemolyticus* is a heat-labile bacterium, readily destroyed at 60°C in 15 minutes. It is susceptible to drying, distilled water, and vinegar in which it dies within a few minutes. The organism, however, can remain viable on freezing and refrigeration.

*V. parahaemolyticus* contains three antigens: somatic O antigens, flagellar H antigens, and capsular K antigen. Serotyping is based on O and K antigen.

- Thermostable direct hemolysin is the key virulence factor of *V. parahaemolyticus*. This virulence factor is found only in strains that are pathogenic to human beings.
- Strains isolated from humans possess this toxin, hence are pathogenic, while strains isolated from environment source, such as water, crabs, oysters, or fish do not possess this thermostable toxin, hence are nonpathogenic.

## Key Points

### Kanagawa phenomenon

In this test, the pathogenic strains of *V. parahaemolyticus* when grown on a special high-salt mannitol medium (Wagatsuma agar) show hemolysis on blood agar. This hemolysis is caused by a thermostable hemotoxin released by pathogenic strains, which are known as Kanagawa-positive strains. Nonpathogenic strains isolated from environment that do not cause any hemolysis on the blood agar are called Kanagawa-negative strains.

*V. parahaemolyticus* is widely distributed in estuary and marine environments. Seafood, such as fish, crabs, or oysters, is the main source and reservoir of infection. The infection is acquired on consumption of contaminated seafood.

*V. parahaemolyticus* in humans causes gastroenteritis. The severity of the condition can vary from mild self-limited diarrhea to an acute illness. After an incubation period of 5–72 hours, the patients with gastroenteritis manifest as eosinophilic watery diarrhea. The condition is associated with nausea, vomiting, abdominal pain, and low-grade fever, which may be present for 3 days. Stool usually does not contain any blood or mucus, but contains cellular exudates. The patient usually recovers within 3 days.

*V. parahaemolyticus* also causes extraintestinal infections, such as wound infections and ear and eye infections in individuals exposed to contaminated sea water.

*V. parahaemolyticus*, although widely found in sea fish in some parts of India, is relatively less common in human infections.

### *Vibrio alginolyticus*

*V. alginolyticus* is another halophilic vibrio. It shows a high salt tolerance and can grow even in the presence of 10% sodium chloride. On TCBS agar, it forms large yellow sucrose-fermenting colonies. It shows swarming on the surface of nonselective medium, such as blood agar. *V. alginolyticus* is widely distributed in sea water and seafood. *V. alginolyticus* is associated with infections of superficial wounds exposed to contaminated sea water. It also has been associated with infections of the gastrointestinal tract, ear, and eye. Differentiating features of *V. parahaemolyticus* and *V. alginolyticus* are summarized in Table 35-5.

### *Vibrio vulnificus*

*V. vulnificus* is a halophilic vibrio, formerly known as L+ vibrio, or *Benekea vulnificus*. Like *V. parahaemolyticus*, *V. vulnificus* is a Gram-negative bacillus and facultative anaerobe that requires salt for growth. It also produces green nonsucrose-fermenting colonies on TCBS medium. It differs from *V. parahaemolyticus* and other *Vibrio* species by its ability to ferment lactose. Relatively, *V. vulnificus* is a more virulent bacterium than *V. parahaemolyticus*. Presence of capsule and production of hydrolytic enzymes, such as cytolysins, proteases, and collagenases

TABLE 35-5

Differentiating features of *Vibrio parahaemolyticus* and *Vibrio alginolyticus*

Properties	<i>Vibrio parahaemolyticus</i>	<i>Vibrio alginolyticus</i>
Growth in 10% agar	–	+
Presence of swarming	–	+
Fermentation of sucrose	–	+
VP test	–	+

are responsible for virulence of the bacteria. These organisms are also resistant to complement- and antibody-mediated lysis.

*V. vulnificus* is a natural inhabitant of sea water. *V. vulnificus* infections are usually food-borne diseases and are largely associated with (a) ingestion of raw or undercooked seafood and (b) exposure of wound to contaminated sea water.

*V. vulnificus* infection in humans produces two types of illness: (a) wound infection and (b) gastroenteritis rapidly progressing to septicemia. Wound infection caused by contaminated sea water has a short incubation period of 3–24 hours. These wounds are usually present on the fingers, palms, or soles of the feet. The condition rapidly progresses to necrosis, gangrene, or necrotizing fasciitis. The wound infection in patients with cirrhosis or malignancies may progress very rapidly with development of hemorrhagic bullae and extensive soft tissue necrosis.

Gastroenteritis rapidly progressing to septicemia occurs following the consumption of raw seafood on exposure of broken skin to warm sea water after a short incubation period of 12–48 hours. The bacteria on ingestion penetrate the intestinal mucosa, but do not cause any gastrointestinal manifestations and enter blood stream rapidly, causing septicemia. The condition manifests as multiple hemorrhagic bullae and extensive ecchymosis distributed mainly on the lower extremities. Patients frequently become hypotensive and develop oliguria and noncardiogenic pulmonary edema. This condition is associated with mortality rate as high as 50%.

Diagnosis of the condition is made by isolation of the bacteria from wounds and blood.

Since *V. vulnificus* produces life-threatening illness, immediate and prompt treatment with antibiotics is essential. Tetracyclines or aminoglycosides are the antibiotics of choice for treatment of the condition. The condition is prevented by avoidance of raw and undercooked seafood.

### Other *Vibrio* Species

Other *Vibrio* species associated with occasional human infection include *Vibrio fluvialis*, *Vibrio furnissii*, *Vibrio damsela*, and *Vibrio hollisae*. These species are associated with gastroenteritis, wound infections, and bacteremia. Rare infections of bacteremia by *Vibrio metschnikovii* have also been documented (Table 35-1).

TABLE 35-6

### Differentiating features of *Vibrio*, *Aeromonas*, and *Plesiomonas* based on utilization of amino acids

Utilization of amino acids	<i>Vibrio</i>	<i>Aeromonas</i>	<i>Plesiomonas</i>
Lysine decarboxylation	+	–	+
Ornithine decarboxylation	+	–	+
Arginine Dihydrolase	–	+	–

## Aeromonas

The members of the genus *Aeromonas* are Gram-negative facultative anaerobic bacilli that morphologically resemble other members of the family Vibrionaceae. At least 16 species of *Aeromonas* have been described, of which 11 species are associated with human disease. *Aeromonas hydrophila*, *Aeromonas caviae*, *Aeromonas veronii*, *Aeromonas schubertii*, and *Aeromonas jandaii* are most important species. *Aeromonas* spp. are Gram-negative motile bacilli with the presence of polar flagella. Few strains are nonmotile. They are catalase positive, oxidase positive, and nitrate positive. They ferment sugars with production of both acid and gas. They grow at an optimum temperature of 32°C and at a pH of 7.

*Aeromonas* spp. are widely distributed in brackish water and in soil. *Aeromonas* species produce many virulence factors, such as enterotoxin, endotoxins, hemolysin, protease, siderophores, and adherence factors. However, the exact role of these virulence factors in the pathogenesis of illness is not known. *Aeromonas* spp. in humans cause gastroenteritis and wound infections.

- Gastroenteritis occurs following ingestion of contaminated food or water. The condition in adults manifests as chronic diarrhea, while in children it presents as acute and severe illness manifested by dysentery with presence of blood and mucus in the stool. Acute diarrhea is a self-limiting condition.
- Wound infection is caused by exposure of the broken skin to contaminated water. *Aeromonas* spp. also cause opportunistic skin diseases in immunocompromised patients, such as patients with malignancy or hepatobiliary disease.

*Aeromonas* species are known to colonize intestinal tract of humans in approximately 3% of individuals. Therefore,

isolation of the bacteria from stool by culture does not indicate disease by *Aeromonas* species. It needs careful interpretation by taking into consideration clinical presentation of the illness.

*Aeromonas* species are susceptible to chloramphenicol, gentamicin, and trimethoprim-sulfamethoxazole. They are resistant to penicillins, most cephalosporins, and erythromycin.

## Plesiomonas

*Plesiomonas* species are oxidase-positive, Gram-negative, and facultative anaerobes that are differentiated from genera *Aeromonas* and *Vibrio* of the family Vibrionaceae by some biochemical reactions (Table 35-6).

*Plesiomonas shigelloides* is the only species described in the genus *Plesiomonas*. It is serologically related to *Shigella sonnei* and hence shows agglutination with *S. sonnei* antiserum. But it differs from *Shigella* by being oxidase positive and motile by the presence of polar flagella.

*P. shigelloides* is motile and Gram-negative rod with rounded ends and measures 0.8–1 μm. It is facultative anaerobe and grows well at 37°C. The bacterium produces nonlactose colorless colonies on MacConkey agar and nonhemolytic colonies on blood agar. It does not grow on TCBS agar. The bacterium ferments inositol with production of acid only, but does not ferment sucrose or starch.

The organisms are ubiquitous in fresh water and brackish water. The bacteria are frequently isolated from dogs, cats, goats, sheep, and other animals, such as frogs, snakes, turtles, and lizards. Humans acquire infection by ingestion of contaminated seafood or contact with amphibians or reptiles.

*P. shigelloides* in humans causes gastroenteritis. The condition occurs after 48 hours of ingestion of the organism. The condition manifests as mild and watery diarrhea with absence of mucus or blood in the stool. This is a self-limiting disease. The bacteria are also associated with uncommon extraintestinal infections, such as cellulitis, septic arthritis, septicemia, neonatal meningitis, etc.

*P. shigelloides* is resistant to ampicillin, erythromycin, and carbenicillin but is susceptible to trimethoprim-sulfamethoxazole, chloramphenicol, cephalosporins, imipenem, and fluoroquinolones.



## CASE STUDY

There was an outbreak of diarrhea during a major festival in which a large number of people participated. More than 20 people were admitted to the local hospital with history of severe watery diarrhea. Most of the patients were dehydrated. They were treated with fluid and electrolytes to maintain fluid balance. All the patients recovered. The stool was positive for *Vibrio cholerae* by culture, and the strain was found to be *V. cholerae* O1 by serotyping.

- What tests will you perform to know whether the isolated strain is Classical or Eltor?
- How does *V. cholerae* cause diarrhea?
- What are the vaccines available against cholera?
- What are the sources and reservoirs of cholera?



# Campylobacter and Helicobacter

## Introduction

The family Campylobacteriaceae consists of two genera of medical importance: *Campylobacter* and *Helicobacter*. The genera belonging to this family are Gram-negative, spiral bacilli with a low DNA guanosine and cytosine base rate. They are microaerophilic and grow only in the presence of a reduced oxygen concentration. They lack the capacity to oxidize or ferment sugars.

## Campylobacter

*Campylobacter* infections are one of the most common bacterial infections in humans. They cause both diarrheal and other systemic diseases. The generic name *Campylobacter* is derived from the Greek word *Kampylos* meaning curved rod. The genus *Campylobacter* resembles the genus *Vibrio* in being motile by means of polar flagella and in being curved Gram-negative bacilli and oxidase positive. They, however, differ from vibrios (a) in being microaerophilic, (b) not fermenting carbohydrates and (c) having a lower guanosine and cytosine content of DNA. The genus *Campylobacter* consists of 18 species and subspecies, of which 11 species are known to cause infections in humans. These species cause both intestinal and extraintestinal diseases (Table 36-1). *Campylobacter jejuni* and *Campylobacter fetus* are the two most important species that cause most of the *Campylobacter* infections in humans.

## Properties of the Bacteria

### ► Morphology

*Campylobacter* spp. shows following morphological features:

- *Campylobacter* are small, comma-shaped, Gram-negative rods. They vary in width from 0.2 to 0.5  $\mu\text{m}$ .
- They show a rapid darting motility in cork screw fashion by means of a single polar flagellum at one or both poles (*monotrichous/amphitrichous*).
- They are nonsporing bacteria.

### ► Culture

*Campylobacter* spp. grow more slowly than other enteric bacteria. *Campylobacter* are microaerophilic, requiring an atmosphere

TABLE 36-1

### Human infections caused by *Campylobacter* species

Bacteria	Diseases
<i>Campylobacter jejuni</i>	Gastroenteritis, septicemia, meningitis, proctitis, and Guillain-Barre syndrome
<i>Campylobacter jejuni</i> subsp. <i>doyle</i>	Gastroenteritis, gastritis, and septicemia
<i>Campylobacter fetus</i>	Gastroenteritis, septicemia, meningitis, and proctitis
<i>Campylobacter fetus</i> subsp. <i>venerealis</i>	Septicemia
<i>Campylobacter coli</i>	Gastroenteritis, septicemia, meningitis, and spontaneous abortion
<i>Campylobacter upsaliensis</i>	Gastroenteritis, septicemia, and abscesses
<i>Campylobacter hyointestinalis</i>	Gastroenteritis
<i>Campylobacter showae</i>	Periodontal disease
<i>Campylobacter curvus</i>	Periodontal disease
<i>Campylobacter rectus</i>	Periodontal disease
<i>Campylobacter concisus</i>	Periodontal disease and gastroenteritis
<i>Campylobacter lari</i>	Gastroenteritis and septicemia

with decreased oxygen concentration (5%) and increased carbon dioxide concentration (5–10%) for their growth. Most species including *C. jejuni*, *Campylobacter coli*, *Campylobacter lari*, and *Campylobacter hyointestinalis* grow well at 42°C, hence are called thermophilic bacilli.

Selective media for *Campylobacter* species are blood-based and antibiotics-containing media, such as Skirrow's, Butzler, and Campy-BAP selective media. *Campylobacter* on these media produce well-formed colonies after 48 hours of incubation.

*C. jejuni* produces moist, gray or colorless, flat, and non-hemolytic colonies on this medium. Other *Campylobacter* species produce circular and convex colonies.

### ► Biochemical reactions

*Campylobacter* spp. show following reactions:

- *Campylobacter* are relatively biochemically inert.
- They do not produce indole.
- They are oxidase positive, catalase positive (*C. jejuni* subsp. *doyle* is an exception), and nitrate positive.
- *C. jejuni* is the only species that hydrolyzes sodium hippurate.

## ► Other properties

**Susceptibility to physical and chemical agents:** *Campylobacter* spp. survive at 4°C in Cary–Blair transport medium for many weeks. *Campylobacter* spp. are sensitive to hydrochloric acid in the stomach, and so conditions that decrease or neutralize gastric acid secretion reduce the amount of inoculum needed to cause disease.

## Pathogenesis and Immunity

*Campylobacter* species are invasive bacteria. In humans, they cause primarily two types of infections: intestinal and extraintestinal. The prototype species for intestinal infections is *C. jejuni* and for extraintestinal infections is *C. fetus*.

## ► Virulence factors

*C. jejuni* possesses many virulence factors, such as enterotoxins, lipopolysaccharide (LPS), adhesins, and cytotoxic enzymes (Table 36-2). However, specific role of these virulence factors in the pathogenesis of disease is not well-known.

## ► Pathogenesis of disease caused by *C. jejuni*

Human infection follows ingestion of 1000–10,000 bacteria, but the illness is infrequent with a dose of less than 10,000 bacteria. Following three mechanisms have been postulated in the pathogenesis of intestinal disease caused by *C. jejuni*:

- 1. Adherence and production of heat-labile enterotoxins:** *C. jejuni* adheres to the jejunum, ileum, and colon. Adherence to epithelial cells or mucus at these sites is possibly facilitated by flagella. LPS or other outer membrane components are also believed to contribute to adhesion. PEB1 is a superficial antigen that has been found to be a major adhesion protein, which is found among *C. jejuni* strains. Furthermore, *C. jejuni* enterotoxin is a heat-labile cholera-like enterotoxin, which is responsible for diarrhea observed during infections.
- 2. Invasion and proliferation of bacteria within the intestinal epithelium:** *C. jejuni* causes characteristic histologic

damage in the mucosal surface of the jejunum, ileum, and colon. The organism produces diffuse, bloody, edematous, and exudative enteritis. Infiltration of lamina propria occurs with neutrophils, mononuclear cells, and eosinophils. It is also associated with crypt abscesses in the epithelial glands and ulceration of the mucosal epithelium. Precise role of enterotoxins and cytopathic toxins in causation of intestinal pathology is not known.

- 3. Invasion of intestinal mucosa and proliferation:** *C. jejuni* invades intestinal mucosa and multiplies in the lamina propria and mesenteric lymph nodes. This results in extraintestinal infections, such as cholecystitis, mesenteric adenitis, urinary tract infection, and meningitis.

*C. jejuni* infection in a small number of cases is associated with Guillain–Barre syndrome, hemolytic uremic syndrome, and thrombotic thrombocytopenic purpura.

## ► Pathogenesis of disease caused by *C. fetus*

*C. fetus* is more frequently associated with systemic infections, such as bacteremia. A single protein, namely, S protein, found in *C. fetus* is the major virulence factor. It inhibits C3b binding responsible for both the serum and phagocytic resistance of the bacteria. Hence, it makes the bacteria resistant to the bactericidal effects of serum.

## ► Host immunity

Acute infection caused by *C. jejuni* confers immunity with development of specific IgG, IgM, and IgA antibody in the serum and also IgA antibodies in intestinal secretions. Both humoral and cell-mediated immunity are important in prevention and termination of *C. jejuni* infections.

## Clinical Syndrome

*Campylobacter* spp. infections in humans can be broadly classified into two major groups: (a) enteric infections and (b) extraintestinal infections.

## ► Enteric infections

*C. jejuni* is the most important species associated with human enteric infections. Other *Campylobacter* species are also associated with enteric infections; these are listed in Table 36-1. The clinical manifestations of enteric infections caused by all the *Campylobacter* species including *C. jejuni* are similar. Watery diarrhea is the main manifestation and occurs in approximately 10% of children. The condition is also associated with abdominal pain, malaise, myalgia, headache, and vomiting. The condition is self-limiting. *C. fetus* may cause intermittent diarrhea and nonspecific abdominal pain. *C. lari* has also been reported to cause recurrent mild diarrhea in children. *Campylobacter upsaliensis* may also cause diarrhea.

## ► Extraintestinal infections

**Bacteremia:** Bacteremia is the most important extraintestinal manifestation. Bacteremia caused by *C. jejuni* is uncommon

TABLE 36-2

Virulence factors of *Campylobacter* species

Virulence factors	Biological functions
Enterotoxins	Facilitate adherence to the jejunum, ileum, and colon
Lipopolysaccharide	Adhesion
PEB1	Superficial antigen that has been found to be a major adhesion protein
Adhesion proteins	Adhesion
Cytotoxic enzymes	Cytotoxicity action
S protein	Found exclusively in <i>Campylobacter fetus</i> and is the major virulence factor. Inhibits C3b binding responsible for both the serum and phagocytic resistance of the bacteria

and occurs in patients with immunodeficiency, chronic disease, and in old individuals. Blood stream infections and bacteremia by *C. fetus* are rare.

**Perinatal infection:** *C. fetus* is the most important *Campylobacter* species known to cause perinatal infection because of its affinity for the genital tract and due to its tropism for fetal tissue. Abortion, stillbirth, and premature labor are the common manifestations. Premature babies show signs and symptoms of sepsis. *C. jejuni* is rarely associated with perinatal infection. *C. hyointestinalis* causes occasional bacteremia in immunocompromised hosts. Guillain–Barre syndrome, reactive arthritis, hemolytic uremic syndrome, and Reiter’s syndrome are some of the noted complications associated with *Campylobacter* infection. Reactive arthritis is another condition seen in patients positive for HLA-B27 and is commonly seen in young patients.

- **Guillain–Barre syndrome:** It is an autoimmune disease believed to be due to molecular mimicry of terminal tetrasaccharide of LPS of *C. jejuni* and glycosphingolipid present on the surface of peripheral nerve. This is a disease of peripheral nerves and is characterized by ascending paralysis. A rare serotype of *C. jejuni* called Penner (LPS type O: 19) is associated with this condition.

## Epidemiology

*Campylobacter* infections are extremely common worldwide.

### ► Geographical distribution

The true incidence of *Campylobacter* infections is not known, because they are non-notifiable diseases. In the United States, an estimated 2 million cases of *Campylobacter* enteritis occur every year, which constitute 57% of cases of gastroenteritis. Average incidence of *Campylobacter* bacteremia in developed countries is estimated to be 1.5/1000 patients with enteritis. In developing countries, although exact figures are not available, *C. jejuni* is frequently isolated from stool of healthy children during 5 years of life. Isolation rates in children ranges from 8% to 45% with an annual incidence as high as 2.1 episodes of *Campylobacter*-associated diarrhea per child.

### ► Habitat

In infected humans, *C. jejuni* inhabits the duodenum, jejunum, and colon. *C. fetus* inhabits the genital tract of infected mothers.

### ► Reservoir, source, and transmission of infection

*Campylobacter* infections are zoonotic. Infected animals are the main reservoir of the infection. The animal reservoirs are the dogs, cats, and other pets that carry the organism in their gastrointestinal tract. Infected animal food products are the source of infection. Transmission of *C. jejuni* to humans occurs by the following methods:

1. Transmission occurs most commonly from infected animals and their food products. Most human infections occur by ingestion of contaminated and improperly cooked

poultry meat products. Infected chickens may account for 50–70% of the infection. The infection also occurs by drinking contaminated raw milk or unpasteurized milk.

2. The infection may also be transmitted from infected animals and humans by feco-oral route on ingestion of food and water contaminated with human or animal feces.
3. The infection may be transmitted from person to person by sexual contact.

*Campylobacter* infection occurs in all age groups. In developing countries, *Campylobacter* enteritis is very common in children younger than 5 years. In contrast, *Campylobacter* bacteremia occurs in patients older than 65 years. *Campylobacter* enteritis is much frequently seen in (a) individuals handling cattle, sheep, and other farm animals, (b) homosexual men, and (c) laboratory workers. *Campylobacter* bacteremia is seen in (a) persons with immunocompromised state (hypogammaglobulinemia, HIV infection, malignancies, etc.), (b) persons with diabetes mellitus and alcoholism, and (c) pregnant ladies.

## Laboratory Diagnosis

The diagnosis of *Campylobacter* infection is confirmed by demonstrating the bacteria by direct examination of feces or isolation of the bacteria by culture.

### ► Specimens

Diarrheic fresh stool is the specimen of choice for enteric infections. Rectal swab may also be used. Other specimens include blood, body fluids, and tissues for diagnosis of extraintestinal infections. In case of delay, feces or rectal swab are transported in Cary–Blair transport medium. *Campylobacter* spp. survive for 1–2 weeks at 4°C in this medium.

### ► Microscopy

Presumptive diagnosis is made by examination of wet mount of stool by dark-field microscopy or phase contrast microscopy. The bacteria are identified by their characteristic darting motility. Gram staining of the stool shows typical Gram-negative, curved rods with a sensitivity of 50–75%. Fecal leukocytes and erythrocytes can also be detected in Gram-stained smear of the stool in approximately 75% patients with *Campylobacter* enteritis.

### ► Culture

Definitive diagnosis of *Campylobacter* enteric infection is best done on isolation of the organism by stool culture. Culture of *C. jejuni* from stool requires special selective media—Butzler medium, Skirrow’s medium, Preston’s *Campylobacter* selective medium, and Blaser’s medium (Campy-BAP). The selective media contain antibiotics that inhibit growth of the other fecal bacteria. Fresh stool specimens collected within 24 hours are inoculated directly on their media. But old stool specimens are first enriched in an enrichment medium, such as Preston *campylobacter* enrichment broth for at least 24 hours at 4°C (cold enrichment) before inoculating on the selective media.

Inoculated media are incubated in 5% O<sub>2</sub> and 10% CO<sub>2</sub> at 42°C for 48 hours. If *C. fetus* or other unusual *Campylobacter* species are suspected, stool specimens are inoculated on media without antibiotics and are incubated at 37°C. Other extraintestinal specimens, such as blood, body fluids, and tissue, can be inoculated on routine media for isolation of *Campylobacter* species.

### ► Identification of bacteria

Preliminary identification of colonies is made by typical Gram-staining features, darting motility, and oxidase test. Definitive identification is made by biochemical tests (Box 36-1).

### ► Histology

Examination by sigmoidoscopy shows widening or proctocolitis in up to 80% of patients with *Campylobacter* enteritis. The histopathological changes include fecal mucosal edema and hyperemia with crypt abscess formation.

### ► Serodiagnosis

ELISA is available for demonstration of specific antibodies in the serum, and a high titer of antibodies is usually seen after the symptoms are resolved. Serology may not be useful for routine diagnosis, but is useful for epidemiological studies.

### Molecular Diagnosis

DNA probes and PCR (polymerase chain reaction) are used for detection of enteric *Campylobacter* infection. These tests, however, continue to be research tools and are not routinely used.

### Treatment

Most *C. jejuni* infections are mild and self-limited. Therefore, they do not require antibiotic therapy. Supportive treatment is adequate. Treatment with antibiotics is recommended only for persons:

- with fever, bloody diarrhea, or
- with symptoms persisting for more than 7 days, and
- for immunocompromised host.

### Box 36-1 Identifying features of *Campylobacter* species

1. Gram-stained smear shows typical Gram-negative curved rods.
2. Shows characteristic darting motility.
3. *Campylobacter jejuni* produce moist, gray or colorless, flat, and nonhemolytic colonies on Skirrow's, Butzler, and Campy-BAP selective media.
4. Biochemically inert; they do not produce indole.
5. Nitrate positive.
6. *C. jejuni* is the only species that hydrolyzes sodium hippurate.
7. Oxidase positive and catalase positive.

Erythromycin is the antibiotic of choice. Ciprofloxacin and tetracycline are the alternative antibiotics, but are not recommended for use in young children. Recently, reports of erythromycin and ciprofloxacin resistant strains have increasingly been documented from many parts of the world.

### Prevention and Control

Thorough cooking of all poultry products and strict personal hygiene (such as washing hands with soap before and after handling raw foods of animal origin) are some of the measures for preventing *Campylobacter* infections.

### *Helicobacter*

*Helicobacter* are *Campylobacter*-like bacteria with a spiral or helical morphology. They are motile by means of sheathed flagella. *Helicobacter* spp. inhabit stomach of humans and many other mammals, such as monkeys, dogs, cats, ferrets, mice, etc. The genus *Helicobacter* consists of many species, which are associated with human diseases (Table 36-3). Of these, *Helicobacter pylori*, *Helicobacter cinaedi*, and *Helicobacter fennelliae* are three important species that cause human infections.

### *Helicobacter pylori*

The association of *H. pylori* with gastritis, peptic ulcer, gastric adenocarcinoma and gastric mucosa-associated lymphoid type (MALT), and B-cell lymphoma is recognized worldwide.

### Properties of the Bacteria

#### ► Morphology

*H. pylori* shows following morphological features:

- *H. pylori* is a curved, spiral, or S-shaped Gram-negative bacillus measuring 3 μm in length and 0.5–0.9 μm in breadth.
- The organism is highly motile and shows cork screw motility due to presence of a unipolar tuft of lophotrichous flagella.
- It is nonsporling.

TABLE 36-3

### Human infections caused by *Helicobacter* species

Bacteria	Diseases
<i>Helicobacter pylori</i>	Peptic ulcer, gastritis, and gastric adenocarcinoma
<i>Helicobacter cinaedi</i>	Gastroenteritis, septicemia, and proctocolitis
<i>Helicobacter fennelliae</i>	Gastroenteritis, septicemia, and proctocolitis
<i>Helicobacter canis</i>	Gastroenteritis
<i>Helicobacter rappini</i>	Gastroenteritis
<i>Helicobacter canadensis</i>	Gastroenteritis
<i>Helicobacter pullorum</i>	Gastroenteritis
<i>Helicobacter heilmannii</i>	Gastritis

► **Culture**

*H. pylori* is microaerophilic and grows in the presence of decreased oxygen concentration (5%) and increased carbon dioxide concentration (10%) in a temperature range between 30 and 37°C. The bacteria do not grow anaerobically, grow poorly at 42°C, and do not grow at all at 25°C. *H. pylori* grows well on freshly prepared chocolate agar and Skirrow’s campylobacter media. *H. pylori* produces circular, convex, and translucent colonies on these media, after incubation of 3–5 days.

► **Biochemical reactions**

*H. pylori* shows following biochemical reactions:

- *H. pylori* produces the enzyme urease, which is almost 100 times more active than that produced by *Proteus vulgaris*. Urease production is the most important feature of *H. pylori*.
- *H. pylori* is catalase and oxidase positive.
- These are biochemically inactive and do not ferment or oxidize sugars, although they can metabolize amino acids by fermentative pathways.

**Pathogenesis and Immunity**

*H. pylori* characteristically cause (a) alteration of gastric acid production, (b) gastric inflammation, and (c) tissue destruction.

► **Virulence factors**

*H. pylori* produces several virulence factors that contribute to the pathogenesis of disease (Table 36-4).

**1. Urease:** The enzyme urease is a very important factor for colonization of *H. pylori* in the gastric mucosa. The enzyme produces ammonia from urea, which in turn increases the pH of the gastric mucosa in the immediate vicinity of the bacterial cell. It helps, therefore, to neutralize gastric acidity and also in colonization of the organism in gastric mucosa. The enzyme also stimulates monocytes and neutrophil chemotaxis and stimulates production of cytokines.

**2. Flagella:** Flagella are also very important for colonization of *H. pylori*. These help the organism to penetrate into gastric mucous layer; hence, it is protected from acidic environment of the stomach.

**3. Adhesins:** These include hemagglutinin, sialic acid-binding adhesins, and Lewis blood group adhesins. All these factors facilitate binding of *H. pylori* to gastric mucosa.

**4. Enzymes:** *H. pylori* produces many enzymes, such as mucinase, phospholipases, superoxide dismutase, and catalase. Both mucinase and phospholipase break down gastric mucus, while superoxide dismutase and catalase prevent phagocytic killing of the bacteria.

**5. Heat shock protein (Hsp-B):** The heat shock protein facilitates expression of the enzyme urease.

**6. Acid inhibitory protein:** This protein causes hypochlorhydria by blocking secretions of acid from parietal cells.

**7. Cytotoxin:** This causes vacuolation in epithelial cells of the host.

► **Pathogenesis of *H. pylori* infection**

*H. pylori* infection begins by colonization of gastric mucosa, which is facilitated by many virulence factors. *H. pylori* blocks the production of acid by its acid-inhibitory protein and also neutralizes the gastric acidity by production of ammonia by splitting urea by the enzyme urease. The biological activity of urease is enhanced further by heat shock proteins. Subsequently, *Helicobacter* through their active cork screw motility pass through gastric mucosa and adhere to epithelial cells. The adhesion is mediated by many adhesin proteins, such as hemagglutinin, sialic acid-binding adhesin, and Lewis blood group adhesin. *H. pylori* are protected from phagocytosis and intracellular killing by enzymes, such as elastases and superoxide dismutase. After adhesion, damage to the epithelial cells is caused by multiple factors, such as mucinases, phospholipases, and vacuolating aflatoxin and by products of urease. Finally, *Helicobacter* infection causes atrophic and even metaplastic changes in the stomach.

TABLE 36-4

**Virulence factors of *Helicobacter* species**

Virulence factors	Biological functions
Urease	Helps in colonization of the organism in gastric mucosa; the enzyme also stimulates monocytes and neutrophil chemotaxis and stimulates production of cytokines
Flagella	It helps the organism to penetrate into gastric mucous layer, hence protects the bacteria from acid environment of the stomach
Adhesins	Facilitate binding of <i>H. pylori</i> to gastric mucosa
Enzymes	Both mucinase and phospholipase break down gastric mucus, while superoxide dismutase and catalase prevent phagocytic killing of the bacteria
Heat shock protein (Hsp-B)	The protein facilitates expression of the enzyme urease
Acid inhibitory protein	The protein causes hypochlorhydria by blocking secretions of acid from parietal cells
Cytotoxin	This causes vacuolation in epithelial cells of the host
Vacuolating toxin (VacA)	Causes vacuolation along with cytotoxin-associated gene protein (CagA)

### ► Host immunity

*H. pylori* infection induces the production of IgM, IgG, and IgA antibodies and also cellular immunity, but they do not appear to confer any protection against the disease.

### Clinical Syndrome

*H. pylori* in humans causes (a) peptic ulcer disease and (b) chronic atrophic gastritis.

### ► Peptic ulcer disease

*H. pylori* is now accepted to be the infective pathogen that causes most of the gastric and duodenal ulcers. Treatment of *H. pylori* infection by specific antibiotics, and thereby the elimination of organism from the stomach, results in healing of these ulcers and in marked reduction in the recurrence of ulcers.

### ► Chronic atrophic gastritis

*H. pylori* infection causes chronic atrophic gastritis during later stage of the illness.

### Key Points

Chronic gastritis is now being recognized as a risk factor for many gastric malignancies:

- **Gastric adenocarcinoma**—the most important complication of *H. pylori* infection;
- **Gastric mucosa-associated lymphoid type (MALT) lymphomas**—this condition shows a better prognosis than gastric adenocarcinoma and is found to regress after elimination of *H. pylori* by treatment; and
- **Squamous cell esopharyngeal cancer**.

### Epidemiology

*H. pylori* is ubiquitous, found worldwide. *H. pylori* infection occurs more frequently in developing countries than in the developed countries.

### ► Geographical distribution

More than 50% of the people are infected worldwide, but the actual incidence of *H. pylori* infection is unknown because exact data are not available from developing countries.

### ► Habitat

*H. pylori* colonize gastric mucosa of healthy persons as well as the persons suffering from peptic ulcer diseases.

### ► Reservoir, source, and transmission of infection

Humans are the primary reservoirs of infection. The prevalence rate of *H. pylori* infection may differ based on geographical area and race. The prevalence rate is approximately 60% in Hispanic persons, 54% in African American persons, and 20% in White persons. Poor hygiene, overcrowding, and poverty facilitate

transmission. The most likely route of *H. pylori* infection is either fecal-to-oral infection (from stool to mouth) or oral-to-oral (stomach contents transmitted from mouth to mouth) contact.

### Laboratory Diagnosis

### ► Specimens

These include stool samples and gastric biopsy specimen.

### ► Microscopy

*H. pylori* is demonstrated by microscopic examination of gastric biopsy specimen stained with Gram, Giemsa, Warthin Starry silver, and hematoxylin–eosin stains. All these stains show organisms of *H. pylori* adhered to gastric mucosa. These methods are highly specific.

### ► Culture

Diagnosis of *H. pylori* infection is made by culture of clinical specimens on freshly prepared chocolate agar and Skirrow's campylobacter selective media followed by incubation at 35–37°C in a microaerophilic environment (5% O<sub>2</sub>, 10% CO<sub>2</sub>, and 85% N<sub>2</sub>) for 3–5 days. *H. pylori* produces convex, circular, and large colonies on these selective media.

### ► Identification of bacteria

Identification of bacterial isolates is made on the basis of typical growth characteristics of *H. pylori* on selective medium; morphology; and oxidase, catalase, and urease test (Box 36-2).

### ► Serology

ELISA is used for demonstration of serum antibodies to *H. pylori* in the patient serum. But since the antibody titers continue to remain elevated a long time after *H. pylori* eradication, antibody-based test cannot distinguish between recent and old infection. ELISA shows a high sensitivity and specificity.

### ► Fecal antigen test

This is an immunochromatographic test, which uses monoclonal antibody for direct detection of *H. pylori* antigen in stool samples. This test is very sensitive (94%) and specific (98%).

### Box 36-2 Identifying features of *Helicobacter pylori*

1. Stained smear shows typical curved, spiral, or S-shaped Gram-negative bacillus.
2. Shows characteristic corkscrew motility.
3. *Helicobacter pylori* produce circular, convex, and translucent colonies on freshly prepared chocolate agar and Skirrow's campylobacter media.
4. Biochemically inert; does not ferment or oxidize sugars.
5. *H. pylori* produce the enzyme urease, which is almost 100 times more active than that produced by *Proteus vulgaris*. Urease production is the most important feature of *H. pylori*.
6. Oxidase positive and catalase positive.

► Urease test

The urease test is the most rapid test, which can be demonstrated directly in the biopsy specimen. In this test, the biopsy tissues are put in a urease indicator medium (0.5 mL urea solution with an indicator) and incubated at 37°C. If *H. pylori* is present, the color of the medium changes due to change of pH of the medium within a few minutes to 2 hours due to the production of ammonia. The test is highly specific (100%), but sensitivity varies from 75% to 95% (Fig. 36-1, Color Photo 37).

► Rapid urea breath test

This test is based on detection of the products of urea degraded by *H. pylori*. In this method, patients drink a beverage that contains urea labeled with a carbon isotope, such as carbon 13 or carbon 14. After a short period of time, the concentration of labeled carbon is measured in the breath. The concentration is high only when urease present in *H. pylori* found in the stomach breaks down the urea. In normal human host, the concentration of the labeled carbon in breath would not be high because the human stomach does not contain any urease. Positive urea breath test indicates *H. pylori* infection. The breath test is a very selective test. Disadvantages of the test are that it may show false positive results in:

- infections with coccoid forms of *H. pylori* that do not produce more urease enzymes and
- patients receiving antibiotics, such as bismuth and histamine-2 blockers.

Treatment

*H. pylori* is sensitive to several antibiotics and to bismuth salts. Use of a single antibiotic or an antibiotic contained with bismuth is not effective. More success has been achieved for treatment of gastric or peptic ulcer by using a combination of bismuth, a proton pump inhibitor (e.g., omeprazole), and one or more antibiotics (ampicillin, metronidazole, clarithromycin, tetracycline). The combination of three types of drug is known as **triple therapy** and is usually given for either 10 or 14 days.

Recently, *H. pylori* strains resistant to macrolides have been reported. Also, some strains resistant to clarithromycin have been documented in children.

Prevention and Control

Improved personal hygiene is important in prevention of the disease.

Other *Helicobacter* Species

*H. fennelliae* (formerly known as *Campylobacter fennelliae*) and *H. cinaedi* (formerly known as *Campylobacter cinaedi*) have been isolated from homosexual men with concurrent HIV and tuberculosis infection suffering from proctitis, proctocolitis, or enteritis. *Helicobacter*-like organisms have been described in the last decade. *Helicobacter mustelae* was first described in ferrets and subsequently, *Helicobacter hepaticus* has been detected in Syrian hamsters by using specific PCR tests. These *Helicobacter*-like organisms do not cause any infection in humans but are suggested as useful animal model for studying *H. pylori* infections. Differences between important *Campylobacter* and *Helicobacter* species are summarized in Table 36-5.

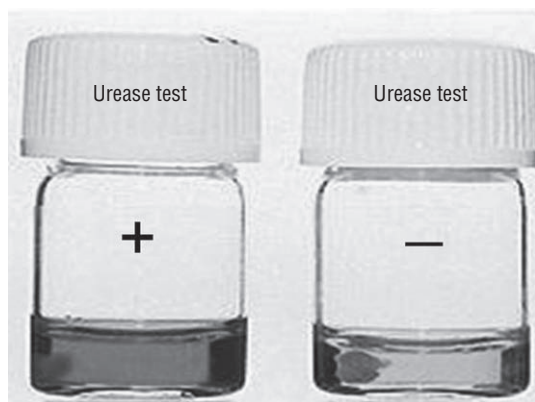

FIG. 36-1. Positive rapid urease test shown by *Helicobacter pylori*.

TABLE 36-5

Differences between growth and biochemical properties of important *Campylobacter* and *Helicobacter* species

	Growth			Hydrolysis		Nitrate reduction	Urease	Growth in 1% glycine
	25°C	37°C	42°C	Hippurate	Indoxyl acetate			
<i>Campylobacter jejuni</i>	-	+	+	+	+	+	-	+
<i>Campylobacter coli</i>	-	+	+	-	+	+	-	+
<i>Campylobacter upsaliensis</i>	-	+	+	-	+	+	-	V
<i>Campylobacter fetus</i>	+	+	-	-	-	+	-	+
<i>Helicobacter pylori</i>	-	+	-	-	-	-	+	-
<i>Helicobacter cinaedi</i>	-	+	-	-	-	+	-	+
<i>Helicobacter fennelliae</i>	-	+	-	-	+	-	-	+

V means variable.

CASE  
STUDY

A 5-year-old child attended OPD of a hospital with his mother complaining of diarrhea associated with abdominal cramp for the last 2 days. The child is restless with a low-grade fever and has been passing the stool mixed with blood. The child had consumed a lunch consisting of boiled rice, green salads, vegetables, and tomato soup. The stool sample was sent to microbiology laboratory for culture. *Campylobacter jejuni* was isolated from the stool through culture.

- Describe the methods for stool culture for isolation of *C. jejuni*.
- List three other *Campylobacter* species known to cause gastroenteritis.
- How will you treat this condition?
- Suggest method for prevention of the condition.



# *Pseudomonas*, *Burkholderia*, and *Moraxella*

## Introduction

*Pseudomonas* and related bacteria are obligatory aerobic non-fermentative and mostly oxidase-positive bacteria. Most of them are motile by presence of one or two flagella. They are ubiquitous bacteria, primarily saprophytic, and are found in soil, water, and in other moist environment. All these bacteria belong to family Pseudomonadaceae, which contains over 200 species. Most of them are pathogenic to plants, insects, and reptiles.

A few species cause disease in humans. These are *Pseudomonas aeruginosa*, *Pseudomonas fluorescens*, *Pseudomonas putida*, *Pseudomonas stutzeri*, *Burkholderia cepacia*, *Burkholderia mallei*, *Burkholderia pseudomallei*, *Stenotrophomonas maltophilia*, *Acinetobacter baumannii*, and *Moraxella catarrhalis* (Table 37-1).

## *Pseudomonas*

*Pseudomonas* are ubiquitous and are found worldwide. They are found in soil, vegetations, water, plants, and animals with a predilection to moist environments. They are also commonly found in hospital environment. They are opportunistic pathogens often causing hospital or nosocomial infections. These

organisms are notorious because of the potency to develop innate resistance to many antibiotics.

## *Pseudomonas aeruginosa*

*P. aeruginosa* is the most important species associated with human infection. It is a most common human saprophyte, but it rarely causes disease in healthy individuals. *P. aeruginosa* causes most of human infections in immunocompromised human host.

## Properties of the Bacteria

### ► Morphology

*P. aeruginosa* shows the following morphological features:

- *P. aeruginosa* is a straight or slightly curved, Gram-negative bacillus measuring  $0.5\text{--}1.0 \times 1.5\text{--}5.0 \mu\text{m}$  in size arranged singly, in pairs, or in short chains.
- It is motile by the presence of a polar flagellum. Occasionally, strains may possess two or three polar flagella.
- *Pseudomonas* spp. is noncapsulated. Although the bacteria are noncapsulated, many strains appear mucoid by production of an abundant of extracellular polysaccharide composed of

TABLE 37-1

Human infections caused by *Pseudomonas* and other genera of the family pseudomonadaceae

Bacteria	Diseases
<i>Pseudomonas aeruginosa</i>	Respiratory tract infections, skin infections, urinary tract infections, ear infections, eye infections, bacteremia, and endocarditis
<i>Pseudomonas fluorescens</i>	Opportunistic infections
<i>Pseudomonas putida</i>	Opportunistic infections
<i>Pseudomonas stutzeri</i>	Opportunistic infections and urinary tract infections
<i>Burkholderia cepacia</i>	Opportunistic respiratory infections in patients with cystic fibrosis or chronic granulomatous disease and urinary tract infections in patients with indwelling catheters
<i>Burkholderia mallei</i>	Acute or chronic infection with infection localized to the skin, subcutaneous tissue, or respiratory tract
<i>Burkholderia pseudomallei</i>	Melioidosis
<i>Stenotrophomonas maltophilia</i>	Nosocomial infections (pneumonia, meningitis, wound infection, etc.)
<i>Acinetobacter baumannii</i>	Nosocomial pathogen of respiratory tract, urinary tract, and wound
<i>Moraxella catarrhalis</i>	Bronchitis and bronchopneumonia seen in patients with chronic pulmonary disease and in elderly patients

alginate polymers. This slime layer forms a loose capsule or glycocalyx around the bacillus. These strains are particularly isolated from patients with cystic fibrosis.

- *Pseudomonas* spp. is nonsporing and fimbriated.

### ► Culture

*Pseudomonas* spp. are strictly aerobic bacteria. *P. aeruginosa* grows over a wide range of temperatures (5–32°C), the optimum temperature being 37°C. *P. aeruginosa* grows on commonly used routine media including nutrient agar, blood agar, MacConkey agar, and deoxycholate citrate agar (DCA).

1. **Nutrient agar:** *P. aeruginosa* after incubation for 24 hours at 37°C on nutrient agar produces large (2–3 mm in diameter), opaque, translucent, and irregularly round colonies. These colonies emit a characteristic musty to fruity odor due to production of aminoacetophenone from the amino acid tryptophan. It produces hemolytic colonies on blood agar.
2. **MacConkey agar:** The organism produces colorless non-lactose-fermenting colonies on MacConkey media.
3. **Cetrimide agar:** Cetrimide agar is a selective medium for culture of *P. aeruginosa*.
4. **Nutrient broth:** In nutrient broth, it produces a dense turbidity with surface pellicle.

*P. aeruginosa* produces different types of pigments, such as (a) pyocyanin, (b) pyoverdin, (c) pyorubin, and (d) pyomelanin. However, some strains of *Pseudomonas* are not pigmented.

- **Pyocyanin** is specifically produced by *P. aeruginosa*, which diffuses into the surrounding medium (Fig. 37-1). The pigment is soluble in chloroform and water.
- **Pyoverdin**, or fluorescein, is produced by *P. aeruginosa* as well as by many other *Pseudomonas* species. These pigments give a yellow tinge to the colonies of bacteria and are best demonstrated in microscope using ultraviolet source of light. Fluorescein is soluble in water, but insoluble in chloroform.

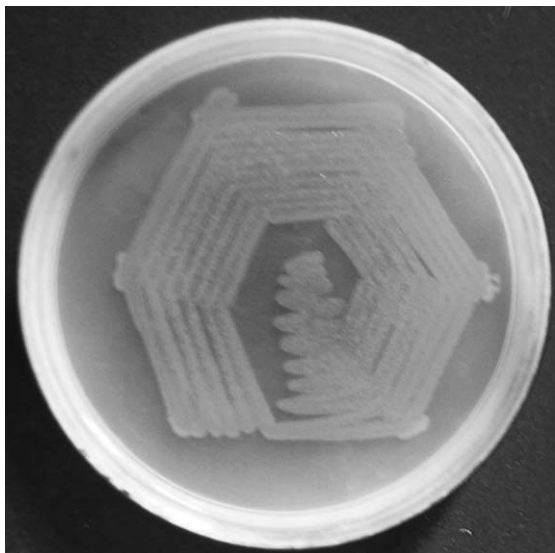

**FIG. 37-1.** *Pseudomonas aeruginosa* showing pigmented colonies on the nutrient agar.

- **Pyorubin** is a red pigment, which is soluble in water but insoluble in alcohol.
- **Pyomelanin** is a brown pigment.

### ► Biochemical reactions

- They are oxidase positive. Oxidase test is an important test for identification of *P. aeruginosa*. All the strains are oxidase positive within 30 seconds of performing the test.
- They are nonfermentative bacteria. They utilize sugars by an oxidase metabolism, with oxygen as the terminal electron acceptor. Special media, such as oxidation-fermentation (OF) media, are used to demonstrate the low quantity of acid produced during oxidative breakdown of sugars. *P. aeruginosa* utilizes glucose, forming acid only (Color Photo 38).
- They do not utilize lactose and maltose.
- They reduce nitrates to nitrite, which is further broken down to gaseous nitrogens.
- They are catalase positive.
- They are arginine dihydrolase positive.
- They are indole, MR, VP, and H<sub>2</sub>S negative.

### ► Other properties

**Susceptibility to physical and chemicals agents:** *P. aeruginosa* is heat-labile bacterium, readily killed at 55°C in 1 hour. It is also highly susceptible to acid, silver salts, 2% alkaline, glutaraldehyde, and disinfectants (such as Dettol and cetrimide). However, *P. aeruginosa* is very strongly resistant to common antiseptics and disinfectants, such as chloroxylenol, hexachlorophene, and quaternary ammonium compounds.

## Cell Wall Components and Antigenic Structure

These include pili, slime layer capsule, lipopolysaccharide, and pyocyanin as described in Table 37-2.

**Pili:** Pili of *P. aeruginosa* are similar to those present in *Neisseria gonorrhoeae*. They are important in mediating adhesion of the bacteria to the epithelial cells.

**Slime layer:** *P. aeruginosa* cell wall is surrounded by loose slime layer. The loose slime layer, also known as alginate coat or glycocalyx, protects the bacteria from phagocytosis and against activity of many antibiotics, such as aminoglycosides. The production of the mucoid slime layer is mediated by genes. These genes are activated in patients suffering from chronic respiratory disease or in those with cystic fibrosis and when colonized.

**Lipopolysaccharide:** The cell wall of *P. aeruginosa* like that of other Gram-negative bacteria contains LPS. The LPS are endotoxins, which constitute a major component of the cell wall and contribute to the sepsis caused by the bacteria.

**Pyocyanin:** Pyocyanin is a pigment that catalyzes the production of superoxide and hydrogen peroxide, and causes tissue damage. This pigment also contributes to inflammation associated with the disease.

TABLE 37-2

Virulence factors of *Pseudomonas aeruginosa*

Virulence factors	Biological functions
<b>Toxins</b>	
Exotoxin A	Acts by prevention of synthesis of proteins in eukaryotic cells; causes tissue damage in chronic pulmonary infection, dermatonecrosis in burns wound, and destruction of cornea in ocular infection; causes immunosuppression
Exoenzymes S and T	These toxins show adenosine diphosphate ribosyl transferase activity, inhibit protein synthesis, and cause immunosuppression
<b>Enzymes</b>	
Elastase	Destroys elastin present in elastin-containing tissues (skin, lung tissue, blood vessels, etc.), immunoglobulins, and complement factors
Alkaline protease	Tissue destruction, inactivation of interferon
Phospholipase C	Causes tissue destruction by breaking down lipids and lecithin
Rhamnolipid	Breaks down lecithin-containing tissues
<b>Cell wall components</b>	
Pili	Adhesion of the bacteria to the epithelial cells
Capsule	Inhibits antibiotics killing of the bacteria
Lipopolysaccharide	Endotoxic activity, sepsis
Pyocyanin	Causes tissue damage, inflammation
Alginate-like exopolysaccharide	Responsible for mucoid phenotype

### ► Antigenic structure

*P. aeruginosa* consists of O and H antigens.

**O antigen:** Somatic or O antigens are the group-specific antigens. *P. aeruginosa* possesses 19 distinct group-specific O antigens, on the basis of which the organism has been classified into 19 serogroups. O antigens are heat stable and can be extracted with acid or formamide. The O antigen can be detected by precipitation reaction-in-gel or by tube or slide agglutination tests using specific antisera produced against these antigens. Some of the O antigens, such as serogroup O2 and O5 show cross-reactivity. *P. aeruginosa* serogroups O6 and O11 are isolated from majority of the clinical specimens. Serogroup O11 has been associated with most of the hospital-acquired infection caused by *P. aeruginosa*.

**H antigen:** Flagella or H antigens are found in the flagella of *P. aeruginosa*. These antigens are heat labile. Two types of H antigens have been demonstrated by slide agglutination tests by using specific antibodies against these antigens.

### Pathogenesis and Immunity

*P. aeruginosa* is an invasive pathogen.

### ► Virulence factors

*P. aeruginosa* invasion is mediated by many virulence factors including toxins, enzymes, and structure of the cell wall (Table 37-2) as follows:

1. **Toxins:** These include exotoxin A, and exotoxins S and T.

2. **Enzymes:** Elastase, alkaline protease, phospholipase C, and rhamnolipid.

3. **Cell wall components:** Pili, loose slime layer, LPS, and pyocyanin.

### Toxins

**Exotoxin A:** Exotoxin A is one of the most important virulence factor produced by *P. aeruginosa*. The toxin like that of the diphtheria toxin acts by preventing synthesis of proteins in eukaryotic cells. Exotoxin A, however, differs from exotoxin of *Corynebacterium diphtheriae* immunologically and structurally. Exotoxin A is less potent than diphtheria toxin. Exotoxin A is responsible for causing tissue damage in chronic pulmonary infection, dermatonecrosis in burns wound, and destruction of cornea in ocular infection. The toxin also causes suppression of immunity in the infected host.

**Exotoxins S and T:** Exotoxins S and T are the toxins produced by *P. aeruginosa*. These toxins show adenosine diphosphate ribosyl transferase activity. These toxins are believed to facilitate spread of bacteria and invasion of tissues followed by necrosis by causing damage in the epithelial cells.

### Enzymes

**Elastase:** The enzyme elastase is of two types: serine protease (LasA) and zinc metalloprotease (LasB). These two enzymes act in combination to destroy elastin present in elastin-containing tissues. These enzymes cause damage in parenchymal tissues of the lung and produce hemorrhagic lesions associated with spreading *P. aeruginosa* infections. These enzymes also facilitate

spread of infection and damage of tissues in acute infections by degrading several components of the complement and also by inhibiting chemotaxis activities of neutrophils. Chronic *P. aeruginosa* infection is associated with development of antibodies to both the enzymes, LasA and LasB, and deposition of immune complexes in the infected tissues.

**Alkaline protease:** Alkaline protease is also responsible for destruction of tissue and dissemination of *P. aeruginosa* infection. The enzyme also interferes with immune response of the host.

**Phospholipase C:** Phospholipase C is a heat-labile hemolysin. It contributes to tissue destruction by breaking down lipids and lecithin.

**Rhamnolipid:** Rhamnolipid is a heat-stable hemolysin. It also contributes to breaking down of lecithin-containing tissues.

### Cell wall

These include pili, loose slime layer, LPS, and pyocyanin as described earlier (Table 37-2).

## Clinical Syndromes

*P. aeruginosa* are opportunistic pathogens as well as true pathogens. *P. aeruginosa* as true pathogen cause infections of the respiratory tract in patients with underlying disease of the respiratory tract. They also cause infection of urinary tract in patients with catheterization. *P. aeruginosa* as opportunistic pathogens causes most of human infections in immunocompromised host. *P. aeruginosa* causes a wide variety of clinical syndromes as follows:

### ▶ Respiratory tract infections

*P. aeruginosa* infection of the lower respiratory tract occurs almost exclusively in patients with malignancies and immunodeficiencies. Primary nonbacteremic *Pseudomonas* pneumonia usually occurs in patients who have been colonized earlier with *P. aeruginosa*. This colonization is seen in patients with cystic fibrosis, other chronic disease, and in those with neutropenia. The condition manifests typically as a bilateral, diffuse bronchopneumonia often associated with pleural effusion. The condition is associated with a high mortality rate of 70%. The conditions that increase susceptibility of these patients to infection with *P. aeruginosa* include:

- Use of respiratory instruments during therapy, which may introduce these bacteria to the lower respiratory tract.
- Use of broad-spectrum antibiotics that inhibit normal microbial flora of the respiratory tract.

### ▶ Skin infections

*P. aeruginosa* can cause a variety of skin infections, such as infections of burn wound, chronic paronychia, infected toe web, pseudomonal folliculitis, and pseudomonal cellulitis. Infection of burn wounds is the most common recognized condition caused by *P. aeruginosa*. Pseudomonal wound infection is

characterized by the presence of dark brown eschar associated with edema and hemorrhagic necrosis.

*Pseudomonas* skin infections are commonly seen in patients who are exposed to moisture. Pseudomonal toe web infection is seen more commonly in children than in adults who are exposed to contaminated water in swimming pools, hot tubs, etc. *P. aeruginosa* causes paronychia (i.e., infection of the nail) in individuals whose hands are more exposed to water.

### ▶ Urinary tract infections

*P. aeruginosa* causes urinary tract infections in persons with indwelling urinary catheters and in persons undergoing instrumentation and surgery of urinary tract. These infections usually are hospital acquired and iatrogenic.

### ▶ Ear infections

*P. aeruginosa* is one of the common agents causing external otitis in patients with history of swimming. The species is also responsible for causing malignant external otitis, a virulent form of disease that occurs primarily in patients with diabetes or acquired immunodeficiency syndrome (AIDS) and in elderly patients.

### ▶ Eye infections

*P. aeruginosa* causes pseudomonal endophthalmitis. The condition may occur following trauma, intraocular surgery, or posterior perforation of corneal ulcer. Persons wearing contact lens are at increased risk of developing pseudomonal infection.

### ▶ Endocarditis

Cardiovascular infections, such as pseudomonal infectious endocarditis, are caused by involvement of both normal and abnormal valves (tricuspid, aortic, and mitral valve) on both sides of the heart. This condition leads to destruction of heart valves and subsequent heart failure. This condition is most commonly seen in patients who are intravenous drug abusers of pentazocine and triphenylamine.

### ▶ Nosocomial infections

Most infections caused by *P. aeruginosa* are opportunistic infections seen in immunocompromised host. Such immunocompromised hosts include:

- Persons with dysfunctional immune mechanisms, such as those occurring in AIDS, cystic fibrosis, neonates, complement deficiency, hypogammaglobulemia, and neutropenia.
- Patients with injury to the skin and mucocutaneous membrane that occurs during burn injuries and during use of urinary catheters, dialysis catheters, endotracheal tubes, and intravenous lines.

*P. aeruginosa* causes bacteremia—a condition clinically similar to Gram-negative bacteremia in immunocompromised patients. It also causes pseudomonal meningitis, which occurs in patients who are immunocompromised or have undergone neurosurgery.

## Epidemiology

*P. aeruginosa* are the opportunistic pathogens, causing infection, distributed worldwide.

### ► Geographical distribution

*P. aeruginosa* infection is ubiquitous in most environmental places in the hospital. The bacteria are specially found in the hospital environment, such as toilet, bath tubs, wash basins, respiratory and dialysis equipments, kitchens, and even in anti-septic or disinfectant solutions.

### ► Habitat

*P. aeruginosa* is a common human saprophyte present widely in the environment. In hospitalized patients, *P. aeruginosa* transiently colonizes the respiratory and gastrointestinal tract of the patients. The colonization is common in patients, particularly those hospitalized for a very long period, treated with broad-spectrum antibiotics over a long duration, and those exposed to respiratory therapy by instrumentation.

### ► Reservoir, source, and transmission of infection

Hospital environment is the most common source and reservoir of infection. Pseudomonal infections are transmitted through aerosols and by contact with infectious materials. *P. aeruginosa* is responsible for nearly 5–15% of hospital or nosocomial infections.

### ► Pyocin typing

Typing of *P. aeruginosa* based on the production of pyocin is the most commonly used method for typing *P. aeruginosa* strains. These are used in epidemiology studies. Pyocins are bacteriocins produced by *P. aeruginosa*. Three types of pyocins are produced. They are R, F, and S pyocins. The capability to produce these pyocins is observed in more than 90% of strains of *P. aeruginosa*. Those strains that produce pyocins are resistant to their own pyocins, but are sensitive to those produced by other strains.

## Laboratory Diagnosis

Laboratory diagnosis of pseudomonal infection is based on isolation of *P. aeruginosa* from feces or other clinical specimens containing mixed microbial flora by culture on selective medium, such as cetrinide agar. Since *P. aeruginosa* is frequently present as a contaminant in the clinical specimen, hence not a single isolation but repeated isolations are essential to confirm *P. aeruginosa* as the causative agent of condition.

### ► Identification of bacteria

Nonlactose-fermenting and beta-hemolytic green pigmented colonies (Color Photo 39), which are rapid oxidase positive, are identified by biochemical properties, production of pyocins, and susceptibility to phage typing, serotyping, and molecular typing (Box 37-1).

### Box 37-1 Identifying features of *Pseudomonas aeruginosa*

1. Gram-stained smear shows small Gram-negative bacilli.
2. Nonlactose-fermenting colorless colonies on MacConkey agar.
3. Beta-hemolytic green pigmented colonies on blood agar with typical odor.
4. Motile.
5. Nonfermenter.
6. Oxidase positive.

## Treatment

Treatment of *Pseudomonas* infection is by specific antimicrobial therapy. However, *P. aeruginosa* shows a considerable degree of resistance to many of the commonly used antibiotics. *Pseudomonas* are susceptible to cefotaxime, ceftazidime, gentamicin, tobramycin, carbenicillin, azlocillin, and ticarcillin. Ciprofloxacin is most frequently used antibiotic, because it is active against *P. aeruginosa* in most tissues. *Pseudomonas* infections are treated best with combination of at least two antipseudomonal antibiotics. A combination of aminoglycosides or quinolone with another antipseudomonal antibiotic is effective for most of the *Pseudomonas* infections.

Treatment with a combination of two antibiotics is usually not recommended for single urinary tract infection, local skin infection, or in febrile leukopenic patients.

### Key Points

Antimicrobial therapy of *P. aeruginosa* infection is frequently problematic due to the following reasons:

- Most strains are intrinsically resistant to most commonly used antimicrobial agents. They can become more resistant during therapy with antibiotics. The mutation of the genes encoding for outer membrane porin proteins is most commonly responsible for development of resistance.
- They also produce many beta-lactamases, which cause inactivation of many beta-lactam antibiotics such as penicillins, cephalosporins, carbapenems, etc.

Treatment with hyperimmune globulin and granulocytic transfusion may be useful. Treatment of underlying diseases and appropriate supportive therapy is also crucial for treatment of pseudomonal infections.

## Prevention and Control

Prevention of *Pseudomonas* infections, particularly in hospitals, is always difficult. It requires constant monitoring and strict attention to asepsis. The measures suggested for hospital infection control practices are based on:

1. Prevention of cross-infection of patients by attending medical and paramedical personnel.
2. Prevention of contamination of equipments, such as dialysis machine and respiratory instruments and restricting the use of broad-spectrum antibiotics. The latter suppresses

normal microbial flora and facilitates the overgrowth of resistant *Pseudomonas* organisms.

- Pseudomonas* vaccines have been evaluated in specialized situation, such as cases of cystic fibrosis that are highly susceptible to *Pseudomonas* infections.

### Other *Pseudomonas* Species

*P. stutzeri*, *P. putida*, *Pseudomonas maltophilia*, and *P. fluorescens* are also associated with opportunistic infections in humans. *P. stutzeri* is associated with occasional urinary tract infection. It is a motile bacterium with single polar flagellum, which produces light brown pigmented colonies in culture, and the pigment does not diffuse into the medium.

### *Burkholderia*

The genus *Burkholderia* includes four species, which were formerly classified as *Pseudomonas* species. These include *Burkholderia cepacia*, *Burkholderia pseudomallei*, *Burkholderia gladioli*, and *B. mallei*. *B. cepacia* and *B. pseudomallei* are human pathogens, whereas *B. gladioli* and *B. mallei* are not.

### *Burkholderia cepacia*

*B. cepacia*, previously known as *Pseudomonas cepacia*, was first described by Walter Burkholder in 1949. It is the causative agent for bacterial rots in onions. The bacteria were first reported as the causative agent of endocarditis in 1950s. Subsequently, the bacteria are being increasingly reported to be associated with urinary tract infections, catheter-associated bacteremias, and wound infections in humans.

*B. cepacia* is a Gram-negative, motile bacillus and stains irregularly with Gram staining. It is an aerobe, grows well on nutrient agar at 25–30°C. On nutrient agar, the bacteria produce nondiffusible reddish purple pigmented colonies on prolonged incubation. They grow on blood agar; on delayed incubation of 3–4 days, the colonies of *B. cepacia* die. The bacteria do not grow on DCA agar.

*B. cepacia* is oxidase positive. It utilizes glucose, lactose, maltose, and mannitol with production of acid only. It is ornithine decarboxylase and lysine decarboxylase positive. But arginine dihydrolase is negative. *B. cepacia* is a motile bacterium due to the presence of polar tuft of flagella.

*B. cepacia* is an opportunistic pathogen. It is found in moist environment surfaces and is associated with nosocomial or hospital-acquired infections. It causes respiratory infections in patients with cystic fibrosis or chronic granulomatous disease and also urinary tract infections in patients with indwelling catheters. It has also been reported to cause pneumonitis, osteomyelitis, wound infections, and septicemias in patients with contaminated intravenous catheter and endocarditis in drug addicts.

*B. cepacia* is susceptible to trimethoprim–sulfamethoxazole, chloramphenicol, and ceftazidime. But it is inherently resistant to aminoglycosides, polymyxin, penicillins, and cephalosporins.

### *Burkholderia mallei*

*B. mallei*, earlier known as *Pseudomonas mallei*, was first isolated by Loeffler and Scotch in 1882 from a horse suffering from glanders. The bacterium is known to cause glanders, which is a serious disease of equine animals, but capable of transmission to other animals (goats, dogs, and cats) and humans.

*B. mallei* is a slender, Gram-negative, small bacillus measuring 2.5 µm in length. It stains irregularly, often giving a beaded appearance. It is non-motile. It is an aerobe and facultative anaerobe, which can grow on ordinary culture media. It produces small and translucent colonies, which become yellowish on prolonged incubation. It is relatively biochemically inert, fermenting only glucose.

In animals (such as horses), *B. mallei* produces two types of clinical syndrome: glandular and farcy. *B. mallei* can be transmitted occasionally to humans from infected animals suffering from glanders. The infection is transmitted by inoculation of injured skin or the mucous membrane with contaminated discharges. The condition is mostly occupational, found among veterinarians and persons handling horses and other equine animals.

In humans, *B. mallei* may cause acute or chronic infection with that localized to the skin, subcutaneous tissue, or respiratory tract. Human cases of glanders are usually rare. Acute infection is characterized as an acute fulminant febrile disease with mucopurulent nasal discharge and severe prostration. Mortality rate is very high. Chronic infection produces localized abscesses in the skin or respiratory tract.

Glanders in animals may be diagnosed by a skin test known as **Mallein test**. The skin test is similar to the tuberculin test demonstrating a delayed hypersensitivity reaction to protein of *B. mallei*. The condition can also be diagnosed by intraperitoneal inoculation of clinical specimens into male adult guinea pigs. The positive test is demonstrated by appearance of swelling of the testes, inflammation of tunica vaginalis, and ulceration of scrotal skin in 2–3 days of inoculation. This reaction is known as **Strauss reaction**.

*B. mallei* infection is being documented frequently in parts of Asia, Africa, Middle East, Central America, and South America. *B. mallei* is usually sensitive to ciprofloxacin, streptomycin, novobiocin, gentamicin, imipenem, and sulfonamides. Treatment with these antibiotics is usually given for 1–2 months along with surgical drainage of pus from the affected site. *B. mallei* is usually resistant to chloramphenicol.

### *Burkholderia pseudomallei*

*B. pseudomallei* is also known as Whitmore's bacillus, *Malleomyces pseudomallei*, and *Loefflerella pseudomallei*. It is the causative agent of melioidosis (from Greek word, meaning resemblance to distemper of asses) in rodents. *B. pseudomallei* was first described by Whitmore and Krishnaswamy (1902) from a glanders-like disease in humans in Rangol. Subsequently, Whitmore (1913) isolated

the bacillus and gave the name *Bacillus pseudomallei*. Stantum and Felcher (1921, 1925) redesignated the bacteria as *Bacillus whitmore* responsible for melioidosis in humans. Subsequently, this bacterium was renamed as *Pseudomonas pseudomallei* and now it is known as *B. pseudomallei*. *B. pseudomallei* is saprophyte found in contaminated water, soil, and plants. *B. pseudomallei* resembles *B. mallei* but differs in being motile; also, it liquefies gelatin and forms acid from several sugars. *B. pseudomallei* causes melioidosis in humans. The condition shows different stages such as acute, local, and chronic infections. The incubation period is variable. It may range from as short as 2 days to as high as too many years.

**Acute melioidosis** is characterized by development of a nodule at the site of inoculation of the bacteria in the skin. The bacteria can subsequently spread, causing secondary lymphangitis, regional lymphangitis, fever, and myalgia. Acute melioidosis may progress rapidly to acute septicemia with high mortality rate. Acute blood stream infection is most commonly seen in patients with HIV, diabetes, renal failure, etc. The condition results in septic shock.

**Pulmonary infection** manifests as mild bronchitis to severe pneumonia. The condition is associated with high fever, headache, chest pain, anorexia, and general myalgia. Nonproductive or productive cough with normal sputum is typical manifestation of this condition.

**Chronic suppurative infection** is associated with multiple caseous or suppurative foci of infection in several organs including joints, skin, lymph nodes, spleen, lungs, liver, and brain. Bacteria remain as intracellular pathogens of the reticuloendothelial system, which contributes to long latency and reactivation of the infection.

Melioidosis caused by the bacteria is endemic in Southeast Asia. In India, most cases of malleiodiosis are reported from Kerala, Tamil Nadu, Maharashtra, Orissa, West Bengal, and Tripura. Diagnosis of the condition is made by:

## Key Points

- Melioidosis is primarily a disease of rats, but also occurs in guinea pigs and rabbits.
  - Humans acquire infection either by inhalation of infected aerosols, inoculation of contaminated material, or ingestion of food and water contaminated with excreta of infected animals.
  - The infection also may be transmitted by the bite of hematophagous insects.
  - Agricultural workers are highly susceptible to infection.
- Demonstration of Gram-negative bacilli in the Gram-stained smears; and also demonstration of typical bipolar safety pin appearance of the bacteria in the methylene blue staining of the clinical specimens, such as exudates.
  - Isolation of *B. pseudomallei* by culture of urine, sputum, pus, or blood confirms the diagnosis of *B. pseudomallei* infection.
  - Serology is frequently helpful for diagnosis of melioidosis, especially chronic melioidosis.
    - ELISA (enzyme linked immunosorbent assay) and IHA (indirect hemagglutination) are used to demonstrate

specific IgM and IgG antibodies in patients with melioidosis.

- PCR (polymerase chain reaction) which has also been evaluated to detect *B. pseudomallei* genome in pus, sputum, and other specimens.

*B. pseudomallei* is susceptible to ceftazidime, which is the drug of choice. Other antibiotics include tetracycline, cotrimoxazole, and chloramphenicol. Prolonged therapy with antibiotics is essential to treat the patient.

## Moraxella

Genus *Moraxella* consists of at least seven species, which can cause infections in humans. These are *Moraxella catarrhalis*, *Moraxella lacunata*, *Moraxella nonliquefaciens*, *Moraxella osloensis*, *Moraxella phenylpyruvica*, and *Moraxella atlanta*. *Moraxella* are Gram-negative cocci or short rods recognized on the basis of nucleic acid analysis. They are arranged mainly in pairs and may be confused with those of gonococci. They are nonmotile, noncapsulated, and nonflagellated bacteria. They are oxidase and catalase positive. They do not produce acid from carbohydrates. They are obligate aerobes and grow well at 32–36°C. They produce small colonies on blood agar after 24 hours of incubation but show poor or no growth on MacConkey agar.

*M. catarrhalis* is the most important human pathogen. It is found as a normal commensal in the respiratory tract of humans. It is a Gram-negative coccus measuring about 0.8 µm in diameter. It is arranged singly or in pairs with adjacent sides flattened. The bacteria are also found in groups of tetrads. They are aerobes. They grow well at optimum temperature of 36°C. Most strains grow on nutrient agar, blood agar, and chocolate agar. On blood agar, after 24 hours of incubation, they produce nonhemolytic, white or grayish, convex colonies with entire margins. On prolonged incubation at 4 hours, the colonies become large with elevated margins and a raised opaque center. The bacteria do not grow on the media selective for gonococci due to the presence of colistin to which it is sensitive. *M. catarrhalis* is:

- oxidase and catalase positive;
- differentiated from *Neisseria* species by positive DNase test and a positive tributyrin hydrolysis test;
- an opportunistic pathogen;
- a common cause of bronchitis and bronchopneumonia seen in patients with chronic pulmonary disease and in elderly patients;
- also associated with sinusitis and otitis, most commonly in healthy people;
- resistant to penicillins due to production of beta-lactamases; and
- susceptible to other antibiotics, such as trimethoprim-sulfamethoxazole, erythromycin, tetracyclines, and cephalosporins.

CASE  
STUDY

A 55-year-old man was admitted to a hospital with 65% burns following an accident in kitchen. The infected pus from the skin showed *Pseudomonas aeruginosa* by culture. The patient was treated for 7 days with broad-spectrum antibiotics. On eighth day of hospitalization, the patient experienced fever and chill. The blood cultures were repeatedly positive for *P. aeruginosa*. The patient succumbed to the infection and died after 15 days.

- What are the factors that increase susceptibility of the patient to *P. aeruginosa* infection?
- What are the virulence factors that make *P. aeruginosa* a serious pathogen?
- What are the mechanisms of antibiotic resistance demonstrated in *P. aeruginosa*?
- How will you prevent nosocomial infections caused by *P. aeruginosa*?



# Haemophilus, Pasteurella, and Actinobacillus

## Introduction

Members of the genus *Haemophilus*, *Pasteurella*, and *Actinobacillus* cause a variety of infections in humans. They require a complex media for their growth and isolation.

## Haemophilus

The members of the genus *Haemophilus* are small, sometimes pleomorphic, Gram-negative, nonmotile, and nonsporing organisms. They require one or both the accessory growth factors, namely, X and V present in the blood. Hence, the genus derived its name from its essential growth requirement of certain factors, such as X and V present in the blood (*haemophilus*: *haem*, blood; *philus*, loving). Koch in the year 1883 isolated *Haemophilus aegyptius*, first member of the genus from a case of conjunctivitis in Egypt.

*Haemophilus* spp. are obligate bacteria present in the mucous membranes of the humans and certain species of animals. *Haemophilus influenzae* and *Haemophilus ducreyi* are two major species associated with disease in humans.

*H. influenzae* causes meningitis, pneumonia, epiglottitis, bronchitis, and otitis media. *H. ducreyi* is the causative agent of sexually transmitted disease, soft chancre, or chancroid. *Haemophilus aphrophilus* is less frequent but an important cause of endocarditis. Other *Haemophilus* species are rarely pathogenic. They are responsible primarily for opportunistic infections (Table 38-1).

## Haemophilus influenzae

*H. influenzae* is the species most commonly associated with human disease. It is an important cause of meningitis in children and also of respiratory tract infection in children as well as in adults.

## Properties of the Bacteria

### ► Morphology

*H. influenzae* is a small, pleomorphic, Gram-negative bacillus. It measures  $1 \times 0.3 \mu\text{m}$ . In fresh cultures, the bacteria are usually coccobacilli, while in older cultures, long filamentous forms are seen. The bacteria are nonmotile, nonsporing, and nonacid fast. Some strains of *H. influenzae* possess polysaccharides capsule. The capsule can be detected by India ink preparation or by capsular swelling reaction using type-specific antiserum.

### ► Culture

*H. influenzae* is a fastidious bacterium. It is facultative anaerobe, grows better in anaerobic condition. The optimal temperature is  $35\text{--}37^\circ\text{C}$ . They do not grow below  $22^\circ\text{C}$ . Presence of 5–10%  $\text{CO}_2$  enhances the growth of the bacteria.

**Growth factors:** *H. influenzae* requires two erythrocytic growth factors, X factor and V factor. These factors are released following lysis of blood cells, thereby allowing growth of fastidious *H. influenzae* on the chocolate agar. *H. influenzae* cannot grow on nutrient agar, because it lacks these growth factors.

TABLE 38-1

Human infections caused by *Haemophilus* species

Bacteria	Diseases
<i>Haemophilus influenzae</i>	Meningitis, epiglottitis, cellulitis, pneumonia, otitis media, bronchitis and conjunctivitis
<i>Haemophilus ducreyi</i>	Soft sore or chancroid
<i>Haemophilus aphrophilus</i>	Subacute endocarditis, brain abscess, pneumonia, and sinusitis
<i>Haemophilus parainfluenzae</i>	Endocarditis, opportunistic infections
<i>Haemophilus aegyptius</i>	Conjunctivitis
<i>Haemophilus haemolyticus</i>	Occasional opportunistic infection
<i>Haemophilus parahaemolyticus</i>	Occasional opportunistic infection
<i>Haemophilus segnis</i>	Occasional opportunistic infection

**X factor:** It is a heat-stable factor present in blood. It is a protoporphyrin IX, hemin, or other iron-containing porphyrin. X factor is required for the synthesis of iron-containing bacterial enzymes, such as catalase, cytochrome oxidase, and peroxidase.

**V factor:** It is a heat-labile factor present in red blood cells and in other animal and plant cells. This factor is destroyed at 120°C in 30 minutes. This factor is also synthesized by *Staphylococcus aureus* and also by some fungi. Earlier this factor was thought to be a vitamin, hence was named V factor. This has now been identified as NAD or NADP coenzyme I. The V factor appears to act as hydrogen acceptor in oxidation–reduction process in a replicating bacterial cell. *H. influenzae* produces large colonies on the blood or chocolate agar by any of the following methods:

- **Chocolate agar:** V factor is released from erythrocytes by heating blood agar at 80–90°C in order to prepare chocolate agar. The released V factor from the erythrocytes supplements the growth of colonies.
- **By using *S. aureus* as source of V factor:** V factor is produced by staphylococci; hence growth on blood agar can be promoted by providing *S. aureus* as source of V factor. Blood agar with *S. aureus* streak is routinely used for culture and identification of *H. influenzae*. In this procedure, a suspected isolate of *H. influenzae* is streaked on a blood agar plate. Then *S. aureus* is streaked across the same blood agar plate and incubated at 37°C for 18–24 hours. After incubation, the colonies of *H. influenzae* nearer to the *S. aureus* are larger than those away from it. This phenomenon is known as **satellitism**. This demonstrates that V factor is available in increased concentration near the staphylococcal colony and in a lower concentration away from it (Fig. 38-1, Color Photo 40).

Fildes' agar or Levinthal's agar are clear and transparent media used for primary isolation and culture of *H. influenzae*. These are prepared by boiling and filtering a mixture of blood and nutrient broth (Levinthal's agar) or by adding a peptic digest of blood to nutrient agar (Fildes' agar).

The capsulated strains of *H. influenzae* produce larger, 1–3-mm diameter, high convex, and mucoid colonies on the media containing blood (chocolate agar, Fildes' agar, or Levinthal's agar) or supplemented with V factors (blood agar

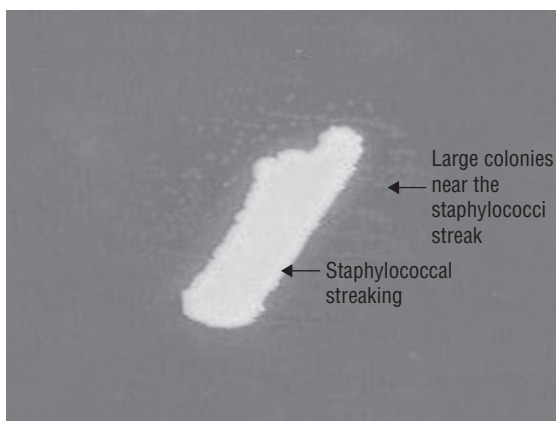

FIG. 38-1. *Haemophilus influenzae* showing satellitism.

showing satellitism). Capsulated strains of *H. influenzae* produce translucent colonies with a conspicuous iridescence on Levinthal's agar. Fildes' agar is used best for primary isolation of *H. influenzae*. In contrast, on these media, noncapsulated strains produce relatively smaller, low convex, smooth, and transparent colonies.

Chocolate agar containing penicillin and bacitracin is usually used for isolation of *H. influenzae* from clinical specimens, which consist of normal bacterial flora.

Growth of *H. influenzae* on ordinary blood agar is scanty and the colonies are small because the V factor is not freely available being found inside the red blood cells. *H. influenzae* does not produce any hemolysis on blood agar.

**Variations:** *H. influenzae* colonies show a smooth to rough variation associated with loss of capsular antigen and subsequent loss of virulence. The genetic characteristics of capsular antigen and antibiotic resistance can be transformed. Nonencapsulated strains of *H. influenzae* can become capsulated by transfer of genetic matter that codes for the capsule.

### ► Biochemical reactions

*H. influenzae* shows the following biochemical reactions:

- It is catalase and oxidase positive.
- It ferments glucose and galactose, but does not ferment lactose, sucrose, and mannitol.
- It reduces nitrates to nitrites.

### ► Other properties

**Susceptibility to physical and chemical agents:** *H. influenzae* is a delicate bacillus. It is readily killed within 30 minutes by moist heat at 55°C. It dies within a few days at 4°C as well as in culture plates and dies in less than 2 days in dried clinical secretions. Bacteria are sensitive to commonly used disinfectants and also to desiccation. Cultures are difficult to maintain due to autolysis. Cultures may be preserved by frequent subcultures on chocolate agar. Lyophilization is a good method for long-term preservation of *H. influenzae* culture.

## Cell Wall Structures and Antigenic Properties

The cell wall of *H. influenzae* is typical of other Gram-negative bacilli; lipopolysaccharide with endotoxin activities is present in the cell wall. Species-specific and strain-specific proteins are present in the outer membranes. Three major surface antigens are present in *H. influenzae*. They are (a) capsular polysaccharide antigen, (b) outer membrane protein (OMP), and (c) lipooligosaccharide.

### ► Capsular polysaccharide antigen

Capsular polysaccharide antigen is the major antigenic determinant of encapsulated *H. influenzae*. This antigen is present in the capsulated strain, which produces a capsule that is polysaccharide in nature. This antigen is not found in unencapsulated strains of *H. influenzae*. The polysaccharide antigen confers

type specificity to the organism and is the basis for grouping of organism into six antigenic serotypes. These six antigenic serotypes are designated as a, b, c, d, e, and f.

Type b capsular polysaccharide is a host-protective antigen, which contains polyribosyl ribitol phosphate (PRP), hence is used in a number of PRP vaccines and PRP-protein conjugate vaccines. These proteins induce IgG, IgM, and IgA antibodies which are bactericidal, opsonic, and protective. *H. influenzae* serotype b was responsible for more than 95% of all invasive *Haemophilus* infection before the introduction of *H. influenzae* type b (Hib) vaccines. But after the introduction of Hib vaccine, specifically directed against *H. influenzae* serotype b, most disease caused by this serotype has been reduced. After the vaccination era, serotypes c and f as well as nonencapsulated *H. influenzae* are responsible for most *H. influenzae* disease.

► **Outer membrane proteins**

The OMP antigens show considerable variations. The OMP antigens of Hib have been classified into 13 subtypes.

► **Lipooligosaccharide**

Lipooligosaccharide is antigenically complex.

**Pathogenesis and Immunity**

*Haemophilus* are the obligate bacteria present in the mucous membranes of humans and certain species of animals. The encapsulated strains, such as strain type b are usually associated with invasive conditions, such as pneumonia, meningitis, septicemia, cellulitis, septic arthritis, etc. The unencapsulated strains primarily cause infections at mucosal surfaces, including otitis media, conjunctivitis, bronchitis, and sinusitis.

► **Virulence factors**

*H. influenzae* produces following virulent factors (Table 38-2):  
**Capsular polysaccharide:** Capsular polysaccharide is the major virulence factor in Hib. This polysaccharide capsule, which contains ribose, ribitol, and phosphate, known as PRP, is antiphagocytic. It resists phagocytosis of the bacteria by leukocytes. Loss of capsule leads to loss of virulence of the bacteria. Antibodies against this capsule are protective. It promotes bacterial phagocytosis and complement-mediated bactericidal activities. These antibodies are produced during natural infection or on vaccination with purified PRP or passive transfer of maternal

antibodies from mother to children. The risk of meningitis and epiglottitis is much higher in patients with no anti-PRP antibodies or in patients with low level of complement.

**Lipid A lipopolysaccharide:** This has been suggested to be responsible for inducing meningococcal inflammation in humans as demonstrated in experimental animal models.

**IgA1 protease:** Both encapsulated and nonencapsulated *H. influenzae* produce IgA1 protease that specifically splits heavy chain of IgA1. Break down of immunoglobulin IgA facilitates colonization of *H. influenzae* on mucosal surface.

**Pili:** Pili help in adherence of *H. influenzae* to epithelial cells.

► **Pathogenesis of *H. influenzae* infection**

*H. influenzae* enters the human host by respiratory route. Pili and nonpilous adhesions of the bacteria mediate colonization of *H. influenzae* in the oropharynx or nasopharynx. Lipid A lipopolysaccharide impairs ciliary function, leading to damage of the respiratory mucosa. A large bacterial load or the presence of concomitant viral infection can potentiate the infection of the bacteria that invade the mucosa and enter the blood stream.

The presence of antibodies, complement components, and phagocytes determines the clearance of bacteremia. The absence of anti-PRP antibodies contributes to bacterial multiplication. Subsequent high-grade bacteremia leads to dissemination of bacteria to various sites including meninges, subcutaneous tissues, joints, and even pleura and pericardium.

Bacteremia usually precedes Hib meningitis and other invasive Hib diseases. Direct extension of infection from the sinuses or ears is rare. The magnitude and duration of bacteremia are the primary determinants of central nervous system (CNS) invasion, which occurs through the choroid plexus.

Meningitis occurs as a result of inflammation, edema, and increased cerebrospinal fluid (CSF) pressure. Brain parenchymal invasion is rare.

Noncapsulated or nontypable influenza strains, which colonize up to 80% of individuals, cause infection by direct extension from the colonized sites. Spread of bacteria by direct extension to sinuses causes sinusitis, to the Eustachian tube causes otitis media, and down the respiratory tract results in bronchitis and pneumonia.

► **Host immunity**

Antibodies directed against the PRP component of capsule play a primary role in conferring immunity. Newborns have a low

TABLE 38-2 Virulence factors of *Haemophilus influenzae*

Virulence factors	Biological functions
Capsular polysaccharide	Polyribosyl ribitol phosphate (PRP) of the capsule is antiphagocytic. It resists phagocytosis of the bacteria by leukocytes
Lipopolysaccharide	Causes meningococcal inflammation
IgA1 protease	Causes break down of IgA, facilitates colonization of <i>Haemophilus influenzae</i> on mucosal surface
Pili	Helps in adherence of <i>Haemophilus influenzae</i> to epithelial cells

risk of infection because of the passive transfer of maternal antibodies. By age of 5 years, most children have naturally acquired antibodies.

## Clinical Syndromes

The clinical syndromes caused by *H. influenzae* can be classified into two types as follows (Fig. 38-2):

1. Infections caused by encapsulated *H. influenzae*
2. Infections caused by nonencapsulated *H. influenzae*

### ► Infections caused by encapsulated *H. influenzae*

**Meningitis:** Meningitis is the most serious manifestation of Hib infection. It occurs primarily in children of 2 months to 2 years of age. Altered mental state and fever are most common symptoms. Headache and photophobia are usually present in older children. Mortality rate is above 90% in untreated children. Hib meningitis is rare in adults.

**Epiglottitis:** Epiglottitis is the second most common infection of *H. influenzae* and is a life-threatening emergency. This condition is seen in children of 3–18 months of age after Hib vaccine era. This condition is characterized by cellulites and obstructive laryngeal edema.

**Cellulitis:** *H. influenzae* causing cellulitis is typically seen in children. The buccal and periorbital regions are most commonly involved. Fever, indurations, and tender area in the head and neck particularly in the buccal and preseptal areas characterize the condition.

**Septic arthritis:** Septic arthritis in children is characterized by involvement of single large joint, such as knee, ankle, hip, or elbow. In adults, joint involvement can be monoarticular or polyarticular.

**Pneumonia:** Pneumonia typically occurs in infants and is clinically indistinguishable from other bacterial pneumonias.

**Suppurative lesions:** Hib can cause suppurative lesions, such as epiglottitis, pericarditis, and septic arthritis. Endophthalmitis, cervical adenitis, osteomyelitis, and endocarditis are less common invasive infections caused by Hib.

### ► Infections caused by nonencapsulated strains

The nontypable influenzae are the opportunistic bacteria causing infections of the upper and lower respiratory tract. These strains cause otitis media, bronchitis, pneumonia, and conjunctivitis. Nonencapsulated *H. influenzae* along with *Streptococcus pneumoniae* is the most common cause of otitis media. Nontypable *H. influenzae* is a major causative agent of conjunctivitis in older children, next only to *S. pneumoniae*. This is the most common cause of community-acquired bacterial pneumonia in adults.

### Key Points

Nontypable *H. influenzae* rarely causes invasive disease. Invasive disease by these strains is associated with malignancies, alcoholism, old age, congenital heart disease, and CNS signs. Nontypable *H. influenzae* infection with chronic obstructive pulmonary disease (COPD) and HIV leads to exacerbation of COPD.

## Epidemiology

### ► Geographical distribution

Hib was a leading cause of infections among children worldwide before Hib vaccines became available. After the availability of the Hib vaccine, the frequency of invasive Hib disease has reduced remarkably even in the developing countries. The frequency of Hib infection has come down to only 2–3 cases/100,000 children below 5 years. So, majority of Hib infection now occurs in (a) nonimmune children due to incomplete vaccination or poor antibody response to the vaccine and (b) in elderly people.

In the developed countries with successful implementation of Hib vaccination program, disease caused by other serotypes of encapsulated bacteria and by nontypable strains of *H. influenzae* is being increasingly recognized.

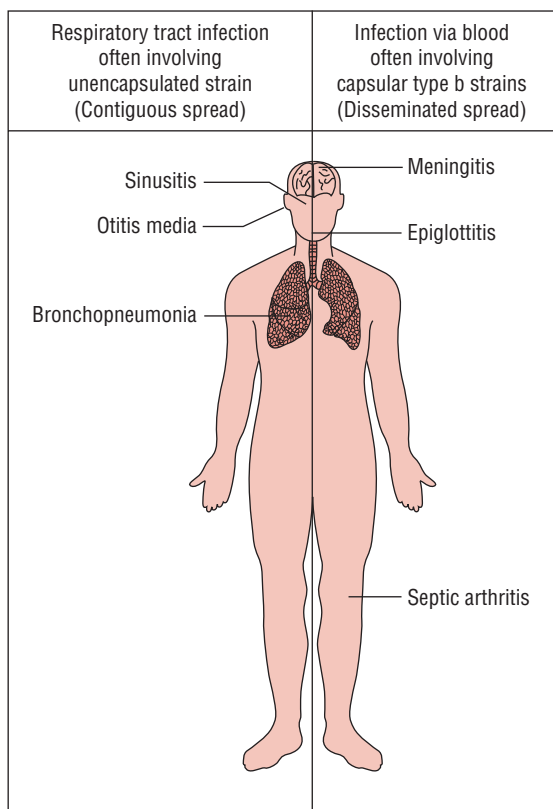

**FIG. 38-2.** Schematic diagram showing infections caused by *Haemophilus influenzae*.

## ► Habitat

*H. influenzae* is a strict human pathogen. Humans are the only natural hosts. Nonencapsulated strains are regular commensals of the nasopharyngeal mucosa and of the oropharynx. They colonize at the site in virtually all children within the first few months of life. In contrast, *H. influenzae* serotype b is rarely found in the upper respiratory tract or, if found, is present in few children (1–5% of cases).

## ► Reservoir, source, and transmission of infection

Human cases are important reservoir of infection. The infected nasopharyngeal mucosal secretion is the most common source of infection. Transmission is by inhalation of respiratory tract droplets or by direct contact. Transmission to neonates occurs through the maternal genital tract. Nontypable *H. influenzae* biotype 4 can colonize the genital tract and is a major cause of invasive disease in neonates.

## ► Biotyping

*H. influenzae* has been subdivided into eight biotypes on the basis of three biochemical reactions: (a) indole production, (b) urease activity, and (c) ornithine decarboxylase activity. Most of the clinical isolates belong to the biotypes I–III. Type b *H. influenzae* belongs to biotype I.

## ► Phage typing and other typing

*H. influenzae* is of four phage types. These are HP1, HP3, S2, and N3. Furthermore, Hib produces bacteriocin, which is known as “hemocin.” This bacteriocin is active against other serotypes of capsulated strains, other species of *Haemophilus*, and against *Escherichia coli*.

## Laboratory Diagnosis

### ► Specimens

CSF and blood are the specimens of choice for the diagnosis of meningitis. One to two milliliters of CSF is usually collected from the patients for performing various tests. In meningitis, the CSF shows pleocytosis (mean 4000–5000 WBC/mL) with a predominance of neutrophils. It shows decreased CSF glucose level and elevated CSF protein.

Blood is a frequently used specimen for culture for diagnosis of cellulitis, epiglottitis, arthritis, or pneumonia caused by Hib. Throat swab, pus, and aspirates from joints, middle ear, and sinuses are the other specimens collected depending on the lesions caused by *H. influenzae*.

All the specimens are collected under strict aseptic conditions in sterile containers. Since *H. influenzae* is very sensitive to low temperatures, the clinical specimens are never refrigerated but are kept in incubator at 37°C before transporting to the laboratory. The specimens are transported immediately to the laboratory for processing and better isolation of the pathogen.

## ► Microscopy

Gram-staining smear of the CSF shows small, Gram-negative coccobacilli in more than 80% of the CSF from cases of untreated meningitis (Fig. 38-3). Gram-stained smear is also useful as a rapid diagnostic method for demonstration of *H. influenzae* in lower respiratory tract disease and arthritis.

## ► Culture

Detection of *H. influenzae* in blood, CSF, or other body fluids by culture confirms the diagnosis of *H. influenzae* infection. CSF culture is useful in cases of meningitis. On chocolate agar or Levinthal’s agar, *H. influenzae* colonies appear as 1–2-mm, smooth, and opaque colonies after 24 hours of incubation. *H. influenzae* on blood agar can also be detected by satellitism as described earlier. Blood culture is useful in the cases of epiglottitis and pneumonia; 70–80% of persons with epiglottitis have positive blood culture result.

## ► Identification of bacteria

The colonies are identified by:

1. Typical colony morphology—1–2 mm, smooth, and opaque colonies after 24 hours’ incubation on chocolate agar.
2. Demonstration of requirements for X and V factors by satellitism (Fig. 38-1).
3. Specific biochemical properties (Box 38-1).

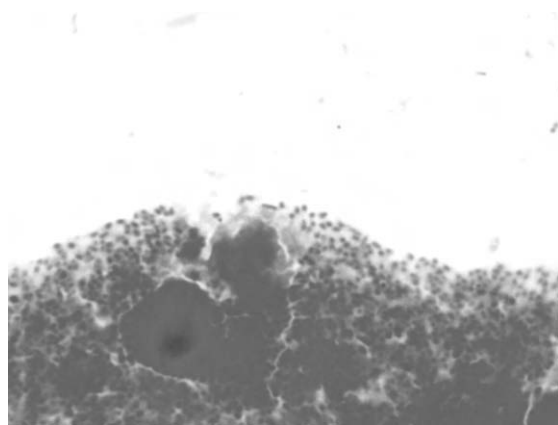

**FIG. 38-3.** Gram-stained smear showing Gram-negative coccobacilli of *Haemophilus influenzae* ( $\times 1000$ ).

### Box 38-1

### Identifying features of *Haemophilus influenzae*

1. Small, pleomorphic, Gram-negative coccobacilli.
2. Demonstrate satellitism on chocolate agar.
3. Ferment glucose and galactose, but do not ferment lactose, sucrose, and mannitol.
4. Catalase and oxidase positive.
5. The serotyping of encapsulated *H. influenzae* is carried out by Quellung reaction, coagglutination, or ELISA methods, and recently by using a DNA probe.

The serotyping of encapsulated *H. influenzae* is carried out by several methods including agglutination reaction, Quellung reaction, coagglutination, enzyme-linked immunosorbent assay (ELISA) methods, and recently by using a DNA probe.

Quellung reaction is carried out by using antisera prepared against type-specific polysaccharide. Fresh isolates from infected patients or primary isolates can be typed by this method. DNA probe is used currently for typing encapsulated *H. influenzae*. The probe hybridizes with a fragment to chromosomal DNA, which codes for the production of capsular antigen. However, noncapsulated strains cannot be typed, hence are called nontypable strains.

### ▶ Antigen detection

Latex agglutination (LAT), co-agglutination (Co-A), counter-current immunoelectrophoresis (CIEP), and ELISA are the tests that can be used to detect polysaccharide antigen b in body fluids.

### Key Points

Detection of *H. influenzae* PRP capsular antigen in the CSF and urine is a rapid and sensitive method for diagnosis of Hib disease. These antigens can be detected by CIEP, LAT, Co-A, and ELISA. The disadvantage of the antigen detection test is that it can detect only Hib infection, but not other capsular serotypes and nonencapsulated strains of *H. influenzae* (because all the strains lack capsule, they do not have capsular polysaccharide antigen).

### Treatment

Antibiotics are the mainstay of treatment of *H. influenzae* infections. *H. influenzae* is susceptible to sulfonamides, chloramphenicol, ciprofloxacin, ampicillin, cefotaxime, and ceftazidime. Cefotaxime and ceftriaxone are the initial drugs of choice of treatment of Hib meningitis. These antibiotics given parenterally to patients with uncomplicated meningitis for 7–14 days are effective. Penicillins are useful in the management of mucosal infections caused by nonencapsulated *H. influenzae*. As many as 25–50% of isolates produce beta-lactamase; therefore, they are resistant to this class of drugs. Beta-lactamase-producing oral antibiotics, with activity against *H. influenzae*, include trimethoprim-sulfamethoxazole, cefuroxime axetil, cefixime, clarithromycin, azithromycin, and ciprofloxacin. These drugs are given for 10 days in cases of otitis media and for at least 14 days for sinusitis.

### Prevention and Control

#### ▶ Vaccination

The Hib conjugate vaccine, now routinely given to infants and children, is highly effective. The vaccine has dramatically reduced the prevalence of invasive Hib disease. The vaccine elicits a protective antibody response and prevents Hib disease by

reducing pharyngeal colonization with Hib. The Hib conjugate vaccine, however, is not effective against disease caused by nontypable *H. influenzae*.

Originally, the Hib vaccine was an unconjugated polysaccharide vaccine, which consisted of the purified PRP capsular polysaccharide. This vaccine, however, was not effective because it induced a poor immune response, did not protect children fully, and did not provide any antibody protection for infants. This therefore led to the development of the conjugate Hib vaccines in which PRP is covalently linked to a protein.

### Hib vaccines

Currently, three types of Hib vaccines are available. These vary in (a) the protein carrier used, (b) the molecular size of the saccharide, and (c) the method of conjugating the protein to the saccharide. These vaccines are:

- (i) HbOC (mutant diphtheria toxin as the carrier protein)
- (ii) PRP-T (tetanus toxoid as the carrier protein)
- (iii) PRP-OMP (major OMP of *Neisseria meningitidis* serogroup B as the carrier protein)

The HbOC or PRP-T is injected in a three-dose regimen, while PRP-OMP is given in a two-dose regimen at 2-months' intervals and first dose is given at age of 2 months. Booster dose is given at the age of 12–15 months. These vaccines are well-tolerated. Occasionally, they cause redness and swelling at the site of vaccination in 10–15% of infants, especially after the first dose rather than after subsequent injections.

### ▶ Chemoprophylaxis

Chemoprophylaxis by rifampin is used to reduce the colonization of Hib disease in children with high risk. Such high-risk group includes children below 2 years in a family or daycare centre where systemic disease is reported.

### Other *Haemophilus* Species

#### *Haemophilus ducreyi*

*H. ducreyi* is an important causative agent of sexually transmitted disease called soft sore or chancroid in Asia and Africa. It is an obligate bacterium. *H. ducreyi* grows poorly on most media, requires X factor, but not V factor, and is biochemically inert. It produces very small colonies (0.5-mm diameter) on chocolate agar after prolonged incubation of 72 hours in the presence of CO<sub>2</sub>.

The chancroid is seen most commonly in men, and the condition remains asymptomatic in women. The incubation period varies from 5 to 7 days, after which a papule with an erythematous surface appears on the genitalia or on the perianal area. Subsequently, the lesion ulcerates and becomes painful. The condition is frequently associated with inguinal lymphadenopathy. Gram-stain smears from the ulcerative lesions show pleomorphic, Gram-negative bacilli. Sulfonamide and tetracycline are the drugs of choice.

## Haemophilus aphrophilus

*H. aphrophilus* is present as a commensal in the mouth and in the throat. On chocolate agar, it forms yellowish, high convex, large colonies (1.5-mm diameter) after 24 hours of incubation. It requires only X factor, but not V factor, and as the name suggests, it also requires high concentration of CO<sub>2</sub> for growth. *H. aphrophilus*, which is present as a commensal in the mouth, can spread to the blood stream and infect previously infected heart valve, causing subacute endocarditis. It can also cause brain abscess, pneumonia, and sinusitis.

## Haemophilus parainfluenzae

*H. parainfluenzae* is an opportunistic pathogen in the upper respiratory tract. Occasionally, the bacteria may cause endocarditis, conjunctivitis, and bronchopulmonary infection. It forms relatively bigger colonies than those of *H. influenzae* on chocolate agar, which are opaque and yellowish white. It differs from *H. influenzae* in requiring the V factor only and not the X factor, fermenting sucrose but not D-xylose.

## Haemophilus aegyptius

*H. aegyptius* was earlier known as Koch-Weeks bacillus. This was observed by Koch in 1883 in a case of acute conjunctivitis and subsequently was first cultured by Weeks in 1887. The organism causes highly contagious form of acute conjunctivitis. It closely resembles *H. influenzae*; however, it differs from *H. influenzae* by being nutritionally more exacting, not fermenting xylose and by not being present as a commensal in the nasopharynx of healthy people.

## Haemophilus haemolyticus

*H. haemolyticus* is present as a commensal in the upper respiratory tract. It is a nonpathogen and does not cause any human disease. On blood agar, it produces a zone of hemolysis around the colonies and may be mistaken for hemolytic streptococci. It requires both X and V factors.

## Pasteurella

*Pasteurella* are nonmotile Gram-negative coccobacilli and are aerobes and facultative anaerobes. They show a bipolar appearance in stained smears. They grow on blood agar and chocolate agar, but show variable growth on the MacConkey agar. They are commonly found as commensals in the oropharynx of healthy animals and cause septicemia in a variety of animals and birds. They are found rarely in the human oropharynx.

The genus *Pasteurella* consists of more than 17 species. *Pasteurella multocida* is the most common species causing infection in humans. Other species, which rarely cause human infections, include *Pasteurella canis*, *Pasteurella dagmatis*, *Pasteurella pneumotropica*, *Pasteurella aerogenes*, *Pasteurella haemolytica*, *Pasteurella caballi*, and *Pasteurella bettyae* (Table 38-3). Most human infections result from animal contact, such as animal scratches, bites, etc.

TABLE 38-3

### Human infections caused by *Pasteurella* species

Bacteria	Diseases
<i>Pasteurella multocida</i>	Cellulitis and adenitis at the site of cat- or dog-bite wound, exacerbation of respiratory tract infections, and systemic infection in immunocompromised patients
<i>Pasteurella canis</i>	Dog-bite wound infection
<i>Pasteurella dagmatis</i>	Dog-bite wound infection
<i>Pasteurella bettyae</i>	Rare opportunistic infection

## Pasteurella multocida

*P. multocida* is a nonmotile Gram-negative bacillus. The organism generally resembles *Yersinia*, but differs from it in being oxidase positive and producing indole. The bacterium grows well on blood and chocolate agars, but grows poorly on MacConkey agar. On blood agar, after overnight incubation, *P. multocida* produces large buttery colonies with a characteristic musty odor of the colonies due to production of indole.

*P. multocida* is present in the upper respiratory tract of dogs, cats, rats, cattle, and sheep. The bacteria sometimes are also present in the human upper respiratory tract. Human infection is rare but may occur following animal bites or trauma. After a bite or scratch by cats or dogs, a localized cellulitis and adenitis occurs at the site of bite. Patients with underlying pulmonary lesions may also show exacerbation of respiratory tract infections (such as pneumonia, bronchitis, sinusitis). *P. multocida* in immunocompromised patients may cause a systemic infection.

Penicillin is the antibiotic of choice. Tetracycline, cephalosporins, or fluoroquinolones are other antibiotics equally effective against the bacteria.

## Actinobacillus

*Actinobacillus* are small, nonmotile, and facultative anaerobic Gram-negative bacilli. The bacteria grow slowly on culture media requiring 2–3 days of incubation. *Actinobacillus* are present in the oropharynx of humans and animals and cause a variety of infections. The genus *Actinobacillus* consists of at least six species, and *Actinobacillus actinomycetemcomitans* is the most important human pathogen. Other species cause very rare human infections (Table 38-4).

## Actinobacillus actinomycetemcomitans

*A. actinomycetemcomitans* is a relatively uncommon agent of periodontitis, endocarditis, and opportunistic infections in humans. *A. actinomycetemcomitans* is so named because the organism is frequently associated with *actinomyces* (Latin word: *comitans* means accompanying). The bacteria in humans constitute the normal flora of the oral cavity, particularly in the gingival and supragingival cervices.

*A. actinomycetemcomitans* grows slowly on chocolate and blood agar producing demonstrable colonies after 2–3 days of incubation. On blood agar, the colonies are smooth, translucent, and nonhemolytic with irregular edges. It does not require X or V factors, but an increased concentration of CO<sub>2</sub> for better isolation of the colonies. It fails to grow on MacConkey agar.

*A. actinomycetemcomitans* is indole negative, urease negative, citrate negative, aesculin negative, and also lysine, ornithine, and arginine negative. It is catalase positive and nitrate reductase positive. It shows a variable oxidase reaction. It ferments glucose, but does not ferment lactose or sucrose.

*A. actinomycetemcomitans* can cause subacute bacterial endocarditis particularly in patients with preexisting valvular heart diseases and oral diseases, such as oral abscess, poor oral hygiene, periodontitis, etc. The bacteria invade oropharynx and blood stream, adhere to the damaged heart valves, and cause the disease. The bacteria are susceptible to aminoglycosides, third-generation cephalosporins, quinolones, chloramphenicol, and tetracyclines. Strains resistant to ampicillin are treated with cephalosporins or fluoroquinolones.

Differential features of important *Haemophilus*, *Pasteurella*, and *Actinobacillus* species are summarized in Table 38-5.

## HACEK Group of Bacteria

The acronym HACEK refers to a group of fastidious slow-growing Gram-negative bacilli—*Haemophilus* species (*H. parainfluenzae*, *H. aphrophilus*, and *H. paraphrophilus*),

*A. actinomycetemcomitans*, *Cardiobacterium hominis*, *Eikenella corrodens*, and *Kingella* species. These organisms are normally present in the oropharynx, which under certain conditions can cause severe infections, such as endocarditis. Since they are fastidious organisms to grow, they are usually incriminated as a frequent cause of culture-negative endocarditis. These organisms also cause a wide variety of diseases including otitis media, conjunctivitis, pneumonia, septic arthritis, osteomyelitis, urinary tract infections, wound infections, brain abscess, periodontal infections, etc. Infective endocarditis (IE) is a major clinical condition caused by HACEK group of organisms:

1. *Haemophilus* species is responsible for 0.5–1% of all cases of IE. Of these, majority (nearly 40%) are caused by *H. aphrophilus*, followed by *H. parainfluenzae*. *H. influenzae* rarely causes IE despite causing bacteremias. Nearly one-third of cases of *H. aphrophilus* IE are due to dental disease and one-fifth are due to sinusitis or otitis media.
2. *A. actinomycetemcomitans* is the causative agent of localized juvenile periodontitis, a presentation of early-onset periodontitis. The condition is characterized by gingivitis and severe periodontal attachment loss. The bacteria also cause IE, especially in patients with underlying heart disease and with infection of prosthetic valve, usually aortic.
3. *C. hominis* are Gram-negative or Gram-variable, pleomorphic bacilli with round swelling of both ends. They are characteristically arranged in chains, clusters, or rosettes. These organisms are present as part of the normal flora of the mouth and upper respiratory tract. These bacteria usually cause infections of the blood stream preceded by oral pathology. *C. hominis* causes endocarditis in majority (75%) of patients with underlying heart diseases. Arterial embolization is also observed in many patients.
4. *E. corrodens* are Gram-negative, pleomorphic, often coccobacillary. They are facultatively anaerobic. They are found as part of the normal oral flora and many other mucosal surfaces. *E. corrodens* is so named due to its ability to corrode the agar during growth in the culture.

*E. corrodens* is a well-known cause of cellulitis following human bites and clenched-fist injuries, soft-tissue infections, and endocarditis in drug addicts. This organism is also associated with a variety of respiratory tract infections including pneumonia, empyema, etc. They cause

TABLE 38-4

### Human infections caused by *Actinobacillus* species

Bacteria	Diseases
<i>Actinobacillus actinomycetemcomitans</i>	Subacute bacterial endocarditis particularly in patients with preexisting valvular heart diseases and oral diseases, such as oral abscess, poor oral hygiene, periodontitis, etc.
<i>Actinobacillus ureae</i>	Opportunistic infections
<i>Actinobacillus hominis</i>	Opportunistic infections
<i>Actinobacillus lignieresii</i>	Bite wound infection

TABLE 38-5

### Differential features of important *Haemophilus*, *Pasteurella*, and *Actinobacillus* species

Organism	Growth factor requirement		Requirement for CO <sub>2</sub>	Fermentation			Catalase
	X	V		Lactose	Glucose	Sucrose	
<i>Haemophilus influenzae</i>	+	+	–	–	+	–	+
<i>Haemophilus ducreyi</i>	+	–	–	–	–	–	–
<i>Pasteurella multocida</i>	–	–	–	–	+	+	+
<i>Actinobacillus actinomycetemcomitans</i>	–	–	+	–	+	–	+



endocarditis in most of the patients with underlying heart valve lesions.

5. *Kingella* species are small Gram-negative bacteria and vary in shapes from cocci to coccobacilli. The genus *Kingella* consists of three species: *Kingella kingae*, *Kingella denitrificans*, and *Kingella indologenes*. *K. kingae* usually causes endocarditis. The endocarditis caused by *K. kingae*, although rare, progresses very rapidly.

Laboratory diagnosis of IE caused by HACEK organisms depends on blood culture, followed by subculture on blood

agar and chocolate agar supplemented with vitamins and other nutrients. The media are incubated in a humid atmosphere of 5% carbon dioxide or anaerobically for 24–72 hours. Blood culture bottles are incubated for a minimum of 14 days, followed by terminal subculture before declaring it negative.

Antibiotics are the mainstay of treatment. Due to delay in blood culture, antibiotics are usually started empirically. Ceftriaxone is the drug of choice. Ampicillin combined with gentamicin is also equally useful. However, of late, resistance to beta-lactams has been reported among HACEK group of organisms.

### CASE STUDY

A 2-year-old child was brought to pediatric OPD with history of fever, headache, convulsions, and vomiting. Physical examination showed presence of neck rigidity and pus in the external auditory canal. Further enquiry revealed that the child had a bout of upper respiratory tract infection in previous week. Provisional diagnosis of bacterial meningitis was made. CSF protein was raised, but glucose was decreased. CSF was sent for Gram stain, culture and sensitivity, and biochemical analysis. Gram stain revealed presence of pus cells and pleomorphic Gram-negative coccobacilli. *Haemophilus influenzae* was isolated by culture.

- Describe the methods followed in a laboratory for isolation of the bacteria.
- Can meningitis caused by *H. influenzae* be prevented by vaccination? Discuss the recent vaccines with their advantages and disadvantages.
- List other infections caused by this organism.
- Which is the antibiotic of choice to treat these bacteria?

# Bordetella and Francisella

## Introduction

Genus *Bordetella* includes the bacteria that are extremely small, strictly aerobic, nonfermentative, and Gram-negative coccobacilli. These are obligate respiratory tract pathogens of warm-blooded animals including birds. The genus *Francisella* includes the bacteria that are strictly aerobic and fastidious, hence cannot be cultured on common laboratory media.

## Bordetella

The genus *Bordetella* consists of seven recognized species; of which, three are responsible for human diseases (Table 39-1). These are *Bordetella pertussis*, agent responsible for whooping cough, or pertussis; *Bordetella parapertussis*, responsible for disease similar to pertussis but the disease is milder; and *Bordetella bronchiseptica*, responsible for pertussis-like symptoms in humans. *Bordetella avium* is a pathogen of birds, which causes infection in turkey poultry, but does not cause any infection in humans.

## Bordetella pertussis

*B. pertussis* (*pertussis*, Latin for intense cough) is the causative agent of whooping cough, an infectious bacterial illness that affects the respiratory tract. Whooping cough is one of many diseases that can be prevented by vaccine.

## Properties of the Bacteria

### Morphology

*B. pertussis* shows the following features:

- *B. pertussis* are extremely small ovoid coccobacilli measuring  $0.2\text{--}0.5 \times 1 \mu\text{m}$ .
- Characteristically, they demonstrate pleomorphism in their morphology.
- They are Gram negative, occurring in singles or in pairs, and are nonmotile and nonsporing.

TABLE 39-1

### Human infections caused by *Bordetella* species

Bacteria	Diseases
<i>Bordetella pertussis</i>	Whooping cough or pertussis
<i>Bordetella parapertussis</i>	Milder form of pertussis
<i>Bordetella bronchiseptica</i>	Pertussis-like symptoms in humans

- Toluidine blue staining of the bacteria demonstrates characteristic bipolar metachromatic granules.
- Freshly isolated strain of *B. pertussis* possesses a poorly defined capsule and also fimbriae.
- In culture smears, the bacilli are arranged in loose clumps with clear spaces in between, giving a thumbprint appearance.

### Culture

*B. pertussis* is a strict aerobe with an optimum temperature for growth  $35^{\circ}\text{C}$ . The bacteria are nutritionally fastidious. They do not grow on common laboratory media, such as blood agar and nutrient agar. Even on blood agar, the bacteria grow slowly and require 3–6 days to form pinpoint colonies.

The bacteria are usually grown on a rich medium supplemented with charcoal, starch, blood, albumin, and growth factors, such as nicotinamide. The latter is absolutely essential for the growth of the bacteria. Blood or albumin present in the medium is used apparently not to provide nutrition for the growth of bacteria but to neutralize toxic substances, such as fatty acids present in the agar.

Bordet–Gengou agar with 15–20% of blood is a common medium used for primary isolation of *B. pertussis*. This medium consists of glycerol, potato, agar, and 15–20% of blood. After 48–72 hours of incubation, *B. pertussis* produces small, smooth, opaque, grayish white refractile colonies resembling bisected pearls or mercury drops. A hazy zone of hemolysis is present around the colonies. Confluent growth of *B. pertussis* on the medium typically presents an aluminum paint appearance.

Charcoal agar with 10% blood has also been used for primary isolation of *B. pertussis*. The bacterium does not grow on MacConkey medium, but other *Bordetella* species grow on this medium.

### Biochemical reactions

*B. pertussis* shows the following biochemical reactions:

- It is oxidase positive and catalase positive but biochemically inert.
- The bacteria do not ferment carbohydrates.
- The bacteria also do not produce indole, do not reduce nitrate, do not split urea, and do not utilize citrate.

### Other properties

**Susceptibility to physical and chemical agents:** *B. pertussis* is killed by heating at  $55^{\circ}\text{C}$  for 30 minutes. It is also killed by drying and also by standard disinfectants. If left on culture plates, the bacteria die within few days, but they can survive in dry droplets for up to 5 days and for 3 days on cloth.

## Cell Wall Components and Antigenic Properties

*B. pertussis* is a Gram-negative bacterium that possesses lipopolysaccharide (LPS) in the outer membrane. The LPS of *B. pertussis* is unusual. It is heterogenous with two distinct types of LPSs, lipid A and lipid X. Both lipid A and lipid X can activate the alternative pathway of complement and stimulate the release of cytokines. The role of their unusual LPS in the pathogenesis of whooping cough is unknown.

*B. pertussis* possesses two types of antigens. These are genus-specific somatic O antigen and strain-specific capsular K antigen. The O antigen is protein in nature, heat-stable, and is of single antigenic type. It is present in most of the strains of *Bordetella*. The K antigen is heat labile. These K antigens are of different types and are used for differentiating *B. pertussis* isolates in epidemiological studies.

A total of 14 agglutinating factors or agglutinogens have been identified based on agglutinin absorption test. *B. pertussis* strains are classified into various types based on the presence of agglutinogens on their capsule. Factor 7 is found in all strains of *B. pertussis* (1–7, 13), *B. parapertussis* (7–10, 14), and *B. bronchiseptica* (7–13).

## Pathogenesis and Immunity

*B. pertussis* colonizes the cilia of mammalian respiratory epithelium. The organism usually does not invade the tissues. In addition, *B. pertussis* causes pertussis or whooping cough in two stages. The first stage is characterized by colonization, multiplication of bacteria, and production of localized tissue damage. The second stage of toxemia is characterized by manifestation of systemic toxicity produced by a myriad of toxins.

### Virulence factors

*B. pertussis* produces several virulence factors (Table 39-2). These include (a) filamentous hemagglutinin (FHA), (b) pertussis toxin, (c) invasive adenylate cyclase, (d) lethal toxin, and (e) tracheal cytotoxin.

**Filamentous hemagglutinin:** FHA is the most important virulence factor, which mediates the attachment of *B. pertussis* to the ciliated epithelial cells of the respiratory tract. It is a

large protein (220 kDa) that forms filamentous structures on the cell surface. FHA binds to galactose residues on a sulfated glycolipid called sulfatide, present on the surface of the ciliated cells. This adhesin also binds to CR3, a receptor present on the surface of polymorphonuclear leukocytes. The intracellular survival of the *B. pertussis* inside the leukocyte protects the bacterium from humoral antibodies against FHA.

Mutations in the FHA structural gene reduce the ability of *B. pertussis* to colonize. Recently, the structural gene for FHA has been cloned, thereby raising the possibility of the production for use in a vaccine.

**Pertussis toxin:** Pertussis toxin is also involved in adhesion of *B. pertussis* to tracheal epithelium. Pertussis toxin is a 105 kDa protein; it is secreted into extracellular fluid and is also bound to the cell wall. Pertussis toxin typically composed of two major units A and B consists of six subunits S1, S2, S3, S5, and two S4 subunits. Unit A is enzymatically active moiety and consists of one toxic subunit S1. The unit B is responsible for binding of toxin to epithelial cells and consists of five binding subunits (S2, S3, S5, and two S4 subunits). The S2 subunit binds to a glycolipid present on the ciliated epithelium. The S3 subunit binds to ganglioside receptor on the surface of phagocytic cells.

Antibodies against pertussis toxin component prevent colonization of the ciliated cells by the bacteria and provide protection against *B. pertussis* infection. Hence, pertussis toxin is a major virulent factor in the initial colonization of the bacteria. Following binding of the B subunit to the epithelial cells, the A subunit is inserted through the membrane and released into the cytoplasm. The A subunit by its enzymatic activity transfers the ADP ribosyl moiety of the NAD to the membrane-bound regulated protein G1, which normally inhibits the eukaryotic adenyl cyclase.

The gene for pertussis toxin has been cloned and sequenced. The toxin is toxoided for use in the component vaccines.

**Invasive adenylate cyclase or hemolysin:** Invasive adenylate cyclase or hemolysin is a 45 kDa protein, which is bound to cell or is also released into the medium. It is a bifunctional toxin with an enzymatic component, i.e., adenylate cyclase activity, and a binding component that mediates attachment to the host cell surface. This toxin is produced by all three *Bordetella* species causing human infections. The adenylate cyclase was originally identified as hemolysin, because it causes lysis of

TABLE 39-2

Virulence factors of *Bordetella pertussis*

Virulence factors	Biological functions
Filamentous hemagglutinin	Binds to galactose residues on a sulfated glycolipid called sulfatide, present on the surface of the ciliated cells; binds to CR3, a receptor on the surface of polymorphonuclear leukocytes; and mediates the attachment of <i>Bordetella pertussis</i> to ciliated epithelial cells of the respiratory tract
Pertussis toxin	Causes adhesion of <i>Bordetella pertussis</i> to tracheal epithelium; S2 subunit binds to glycolipid present on ciliated epithelium; S3 subunit binds to ganglioside receptor on the surface of phagocytic cells; and S1 subunit inhibits the eukaryotic adenyl cyclase, killing of phagocytes, and migration of monocytes
Invasive adenylate cyclase or hemolysin	It has adenylate cyclase activity and a binding component that mediates attachment to host cell surface
Lethal toxin	Causes inflammation and lethal necrosis around the site of adherence of the bacteria
Tracheal cytotoxin	Kills ciliated respiratory cells; also stimulates release of cytokine IL-1 and inhibits ciliary movement

blood cells. This enzyme in fact is responsible for producing zone of hemolysis around *B. pertussis* colonies on blood agar.

**Lethal toxin:** Lethal toxin was earlier known as dermonecrotic toxin. It is a heat-labile protein. It is a 102 kDa protein composed of four subunits: two with molecular weight of 24 kDa. The lethal toxin causes inflammation and lethal necrosis around the site of adherence of *B. pertussis*. The toxin is lethal in high doses in experimental infection of mice. The role of the toxin in the disease is unknown.

**Tracheal cytotoxin:** Tracheal cytotoxin is not a classical exotoxin, because it is not composed of protein, but is composed of a low-molecular-weight peptidoglycan fragment that kills ciliated respiratory cells. It also stimulates release of cytokine IL-1 and is responsible for fever. Tracheal cytotoxin is toxic for ciliated respiratory epithelium and is responsible for inhibition of ciliary movement. The toxin specifically interferes with DNA synthesis, thereby preventing regeneration of damaged cells.

**Other factors:** *B. pertussis* produces at least two other types of adhesins and pertactin, but their role in adherence and pathogenesis remains unknown.

### ► Pathogenesis of pertussis

Infection with *B. pertussis* is initiated by attachment of the bacteria to ciliated epithelial cells of the respiratory tract. The attachment is mediated primarily by two bacterial adhesions, FHA and pertussis toxin. The bacteria multiply at the site of infection, where they produce several toxins that paralyze the tiny cilia and cause inflammation of the respiratory tract (Fig. 39-1).

Pertussis toxin mediates both the colonization and toxemic stage of the disease. The increase in the cyclic AMP levels results in increased respiratory secretions and mucus

production, which characterizes the paroxysmal stage of whooping cough. The S1 subunit of pertussis toxin causes inflammation in the respiratory tract. Pertussis toxin plays an important role not only by mediating adherence to the ciliated epithelial cells but also by its enzymatic active unit, which contributes to the toxemic stage of the infection. The S2 subunit of the pertussis toxin binds to a glycolipid receptor on ciliated respiratory cells.

Further bacterial adherence is mediated by FHA and subsequent bacterial phagocytosis. Subsequently, many other toxins produced by *B. pertussis* also contribute to the pathogenesis of the disease. Adenylate cyclase toxin also inhibits leukocyte chemotaxis, phagocytosis, and killing of the bacteria.

### ► Host immunity

An attack of whooping cough gives lifelong immunity to a child. Secondary attack is extremely rare. The immunity is conferred by specific serum antibodies against *B. pertussis*.

## Clinical Syndromes

*B. pertussis* causes whooping cough, the most common vaccine-preventable disease among children.

### ► Whooping cough

Whooping cough is also known as pertussis. Incubation period varies from 7 to 10 days. The disease typically has three stages (Fig. 39-2): (a) catarrhal stage, (b) paroxysmal stage, and (c) convalescent stage.

**Catarrhal stage:** This is the first stage of whooping cough. This stage resembles that of upper respiratory tract infection with running nose, nasal congestion, sneezing, malaise, and

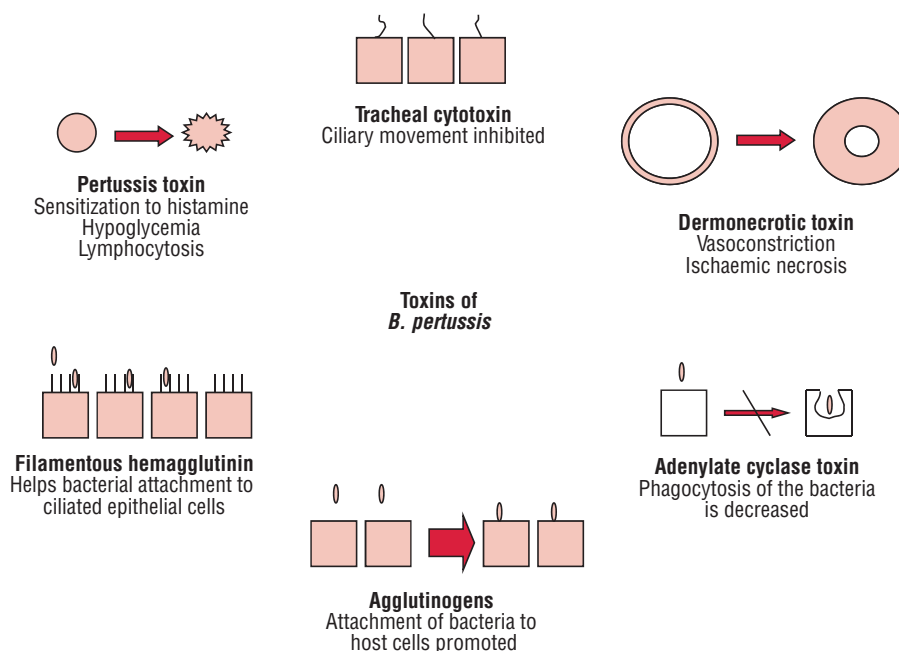

FIG. 39-1. Mechanisms of actions of various toxins produced by *Bordetella pertussis*.

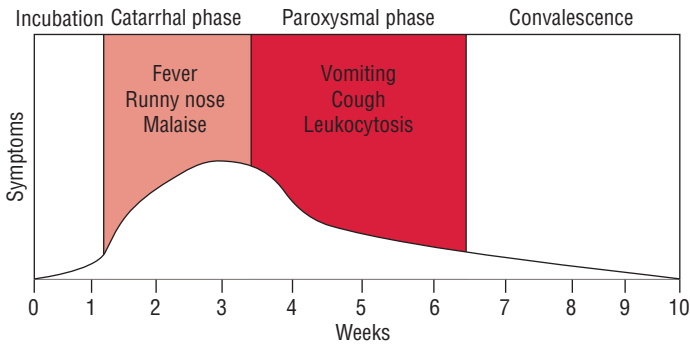

FIG. 39-2. Clinical stages of whooping cough.

occasional cough. A low-grade fever may also be seen. This phase typically lasts 1–2 weeks. This stage is highly infectious because of the production of large number of bacteria during this stage of the disease.

**Paroxysmal stage:** This is the second stage of the disease. This stage is characterized by classic whooping cough or paroxysms. Each paroxysm consists of a series of repetitive intense and drawn out bouts of cough followed by an inspiratory whoop. The attack is more frequent at night with an average 15 attacks in a period of 24 hours. The paroxysm may end frequently with vomiting and exhaustion. During this stage, production of mucus in the respiratory tract is much frequent and is partially responsible for causing obstruction of the respiratory tract. Duration of this stage is highly variable, lasting within 1–6 weeks up to 10 weeks.

**Convalescent stage:** This is the third stage of the disease, which may last for weeks or months. It is characterized by a chronic cough that becomes less paroxysmal. This stage is marked by many complications. These include subconjunctival hemorrhage, respiratory distress, secondary bacterial pneumonia, and neurological complications, such as convulsions. These neurological complications may result in permanent sequelae, such as epilepsy, paralysis, blindness, and deafness.

## Epidemiology

Whooping cough is predominantly a disease of childhood.

### Geographical distribution

Whooping cough is endemic worldwide and affects more than 600,000 million people annually. This is an important cause of mortality in children with estimated 51,000,000 cases and 600,000 deaths annually, particularly in the countries where vaccines are not used regularly.

### Habitat

*B. pertussis* colonizes the cilia of mammalian respiratory epithelium of infected children.

## Reservoir, source, and transmission of infection

Whooping cough is highly contagious. Humans are the only known reservoir of *B. pertussis* infection. An infected child, particularly during catarrhal stage of disease, is the important source of infection. The infection is transmitted primarily by inhalation of air-borne droplets coughed out by the infected patients. The infection is also transmitted by contact with hard surfaces recently contaminated with respiratory secretions or droplets from an infected child. Secondary attack rates are highest (75–100%) among unimmunized household contacts.

Initially, whooping cough was considered to be a disease of young children (<5 years), but now this disease is also seen in older children and adults. They contribute to 25% of cases of whooping cough. This is due to failing immunity over time in adults, even in those who are vaccinated.

## Laboratory Diagnosis

### Specimens

Nasopharyngeal aspirates are the specimen of choice for demonstration of bacteria by microscopy and culture. These samples should be collected during the first stage or early in the second stage of disease, because the organisms are most abundant in the respiratory secretions during these stages of disease. Also, the specimen for culture should be collected before administration of antibiotics. The culture becomes negative 5 days after treatment with antibiotics. The specimens are usually collected by using either calcium alginate or Dacron swabs but not by cotton swabs because the growth of bacteria is inhibited by certain fatty acids in the cotton, which are toxic to *B. pertussis*. The specimens for culture are collected by the following methods: (a) the pernasal swab, (b) cough plate method, and (c) West's postnasal swab.

**The pernasal swab:** In this method, a sterile swab on a flexible wire is passed gently along the floor of the nasal cavity, and the mucus and pus is collected by the swab.

**Cough plate method:** In this method, specimens are directly coughed out by the patient on a culture medium, during a bout of spontaneous or induced coughing in an infected child. The culture plate is held 10–15 cm in front of the patient's mouth. During the process of coughing by children, infected nasopharyngeal secretions are directly deposited on the medium.

**West's postnasal swab:** The West's postnasal swab is usually employed to collect posterior pharyngeal wall secretions through oral cavity. Contamination with saliva should be avoided for better results. The swab containing the mucus and pus is inoculated immediately on freshly prepared medium, such as Bordet–Gengou or charcoal horse blood agar, at the patient's bedside. In case of delay, they are transported in 0.2–0.5 mL casamino acid solution (pH 7.2) or in modified Stuart's transport medium or Regan–Lowe transport medium.

The transport media are transported immediately to laboratory for processing, because even in these media the bacteria cannot survive for long time.

### ► Microscopy

Microscopic diagnosis is made by a direct fluorescent antibody (DFA) technique for demonstration of *B. pertussis* in respiratory secretions. In this method, a smear is made from a specimen on a glass slide, air dried, and heat fixed. This smear is then stained with fluorescent labeled antibody against *B. pertussis*. DFA is a rapid and sensitive method. This method is positive in more than 75% of cases of whooping cough. This technique, however, may show occasional positive reaction in other bacterial infections.

### ► Culture

The specimens are cultured on freshly prepared Bordet–Gengou medium or charcoal horse blood agar medium and incubated in moist environment at 35°C. Incubation even up to 7 days is required, because the colonies are observed only after 3 or more days of incubation.

### ► Identification of bacteria

*B. pertussis* is identified by several characters (refer Box 39-1):

#### Box 39-1 Identifying features of *Bordetella pertussis*

1. Small, round Gram-negative coccobacilli.
2. Demonstrates bisected pearl or mercury drop colonies on Bordet–Gengou agar.
3. Biochemically inert, does not ferment carbohydrates.
4. Catalase and oxidase positive.
5. Bacteria demonstrated by direct fluorescent antibody testing.

### ► Serology

Indirect hemagglutination and ELISA are frequently used to demonstrate IgG and IgA antibodies against FHA and IgG antibodies against pertussis toxin in the patient's sera. A significant rise in the titer of antibodies between acute and convalescent serum in paired sera samples by these tests is suggestive of recent infection. ELISA for demonstration of specific secretory IgA antibodies in nasopharyngeal secretions is also useful, especially in culture-negative cases.

### Molecular Diagnosis

Polymerase chain reaction (PCR) is a new diagnostic method used for diagnosis of whooping cough. It shows a high sensitivity of 80–100%. However, this method is restricted to only a few laboratories.

### Treatment

Erythromycin is the drug of choice. Tetracycline, chloramphenicol, and ampicillin are also effective. These antibiotics

are effective (a) in eradicating the bacteria from the respiratory tract and (b) in reducing the duration of infectivity of the patients. Treatment of pertussis is, however, primarily supported by good nursing care.

## Prevention and Control

Vaccination of infants and children with pertussis vaccine is very effective. The vaccination is usually given for children below 7 years of age.

### ► Vaccines

Vaccines used against pertussis are of two types (refer to the box Vaccines):

1. Whole cell inactivated vaccine
2. Acellular vaccine

### Vaccines

**Whole cell inactivated vaccine:** This whooping cough vaccine has been used for the past five or more decades for protection among children against whooping cough. This vaccine is a merthiolate-killed bacterial cell suspension, which is administered as part of DTP (diphtheria, tetanus, and pertussis) or triple vaccine. These vaccines are effective in 80–85% of population in eliminating asymptomatic pertussis.

These vaccines are given in three doses intramuscularly at an interval of 4–6 weeks before the age of 6 months. This is followed by a booster at the end of first year. First dose is given at 6 weeks. Unfortunately, more than 20% of children who receive whole cell vaccines suffer from mild side effects. Convulsions occur on 0.1% of infants soon after receiving the vaccine. Encephalopathy may occur even in a very few number of cases.

**Acellular vaccines:** Several new multicomponent acellular vaccines have been developed from purified components of *B. pertussis*. The multicomponent vaccine contains FHA, pertussis toxin, fibrin agglutinin, and pertactin. These components are believed to confer protective immunity against whooping cough. This new acellular pertussis vaccine has been found to confer protective immunity similar to that conferred by whole cell vaccine, but the most important advantage is that these vaccines have very low side effects than the whole cell vaccines.

## *Bordetella parapertussis*

*B. parapertussis* is a less frequent cause of whooping cough. The bacteria are responsible for only about 5% of cases of whooping cough. They relatively cause mild disease. *B. parapertussis* organisms differ from *B. pertussis* by their ability to grow on nutrient agar and to produce larger colonies, but the former do not produce pigment (Table 39-3). They are antigenically different from those of *B. pertussis*. Pertussis vaccine does not confer any protection against *B. parapertussis*.

TABLE 39-3

Differential characteristics of *Bordetella* species

Characteristics	<i>Bordetella pertussis</i>	<i>Bordetella parapertussis</i>	<i>Bordetella bronchiseptica</i>
<b>Growth on:</b>			
MacConkey agar	–	+/-	+
Sheep blood agar	–	+	+
Bordet–Gengou medium	3–6 days	1–2 days	1 day
<b>Motility</b>	Nonmotile	Nonmotile	Motile
<b>Oxidase</b>	+	+	–
<b>Urease</b>	–	+	+
<b>Nitrate to nitrite</b>	–	–	+
<b>Citrate utilization</b>	–	+/-	+

### *Bordetella bronchiseptica*

*B. bronchiseptica* is a motile bacterium by virtue of presence of peritrichate flagella. The bacteria grow on nutrient agar and are antigenically related to *B. pertussis* and *Brucella abortus*. It differs from other *Bordetella* species in the biochemical and other properties (Table 39-3). *B. bronchiseptica* is responsible for causing very small proportion (0.1%) of cases of whooping cough.

### *Francisella tularensis*

*F. tularensis* causes tularemia, also known as glandular fever, rabbit fever, tick fever, and deerfly fever—an acute, febrile, granulomatous, infectious disease in humans and other mammals.

### Properties of the bacteria

#### ► Morphology

*F. tularensis* shows the following features:

- *F. tularensis* is a minute ( $0.2 \times 0.2$  to  $0.7 \mu\text{m}$ ) and poorly stained Gram-negative intracellular coccobacillus.
- The bacterium is capsulated and nonmotile.
- Like *Mycoplasma* organisms, this organism is filterable and multiplies, i.e., by filament formation and budding, besides binary fission.

#### ► Culture

Like *Bordetella*, the bacteria are strictly aerobic and fastidious, hence cannot be cultured on common laboratory media. The organism requires enriched media, such as Francis' blood dextrose cystine agar and a longer period of incubation of 3–5 days. *F. tularensis* produces minute transparent colonies on these media after incubation of 3–5 days. However, *F. tularensis* can grow on the chocolate agar if supplemented with cysteine and occasionally will grow on blood agar media.

#### ► Other properties

**Susceptibility to physical and chemical agents:** *F. tularensis* is killed by heating at  $55^\circ\text{C}$  for 30 minutes. It is also killed

by drying and by standard disinfectants. Decontamination of inanimate objects by using 10% bleach followed by using 70% alcohol solution is effective.

*F. tularensis* has two biovars: Jellison type A (*F. tularensis* biovar *tularensis*) and Jellison type B (*F. tularensis* biovar *palaeartica*). These are serologically similar, but differ primarily in their fermentation reactions, virulence, and geographical distribution.

Jellison type A is more virulent and causes severe disease in humans. As few as 10 bacteria injected subcutaneously and 25 bacteria on inhalation can cause disease. This biovar is generally found in North American rabbits and ticks. Jellison type B causes a milder form of disease in humans and is found primarily in Asian and European rodents.

### Pathogenesis and Immunity

*F. tularensis* is one of the most infectious bacteria known. It is classified as a category A agent because of (i) its high infectivity, (ii) ease of dissemination, and (iii) ability to cause substantial illness and death. Humans become infected after introduction of the bacteria by intradermal injection, inhalation, or oral ingestion. Clinical manifestations of disease depend on the mode of infection.

Intradermal injection or inhalations of 10–50 bacilli are required to cause disease. Nearly, 100 million bacteria are required to cause disease on oral ingestion. *F. tularensis* is an intracellular parasite. In infected animals, the bacteria are found in large numbers in the reticuloendothelial cells of spleen, liver, etc. These bacteria remain viable for a longer period in macrophages of the reticuloendothelial system, because the organisms inhibit phagosome–lysosome fusion. Like other Gram-negative bacilli, *F. tularensis* has endotoxin, but is relatively less biologically active than that found in *Escherichia coli* and other Gram-negative bacilli.

Capsulated strains of *F. tularensis* are pathogenic, while non-capsulated strains are nonpathogenic.

### Clinical Syndromes

*F. tularensis* causes tularemia in humans.

## ► Tularemia

The incubation period varies from 3 to 5 days. The onset of the disease is abrupt with symptoms, such as fever, chills, malaise, and fatigue. Tularemia can manifest in one to six well-recognized clinical forms. These include (a) ulceroglandular tularemia, (b) glandular tularemia, (c) oculoglandular tularemia, (d) oropharyngeal tularemia, (e) pneumonic tularemia, and (f) typhoidal (septicemic) tularemia.

## Epidemiology

*F. tularensis* has a worldwide distribution. The infection is found in more than 100 species of animals, birds, amphibians, and arthropod hosts. The organism may also be found in mud and water.

## ► Geographical distribution

Tularemia occurs throughout the Northern Hemisphere except the United Kingdom. Cases have been reported in the former Soviet Union, Japan, Canada, Mexico, the United States, and Europe. The condition has not been described in either Africa or South America.

## ► Reservoir, source, and transmission of infection

Rabbits, ticks, and muskrats are the reservoir of infections. Domestic cats are also now increasingly recognized as reservoirs of tularemia. Ticks and deerflies (*Chrysops discalis*) are common vectors. Hard ticks (*Amblyomma americanum*, *Dermacentor andersoni*, and *Dermacentor variabilis*) are also important vectors and reservoirs due to the vertical transmission of their progeny.

Contact with infected animals or their carcasses is the primary mode of transmission. The infection is transmitted by (a) ingestion of poorly cooked meats of the infected animals, such as rabbit, (b) ingestion of contaminated water, (c) bite of a tick or deerfly, (d) direct contact with contaminated soil, water, or fomites, and (e) inhalation of water aerosols or dust from soil, grains, or contaminated pelts. However, person-to-person transmission is rare.

## Laboratory Diagnosis

*F. tularensis* is a highly infectious bacterium. Hence, isolation of the bacteria from clinical specimens is not attempted in routine laboratories because culture poses a danger to laboratory workers. The plates must be sealed and handled by using a bio-safety level (BSL)-2 facility that is essential for handling the culture plates and BSL-3 facility for isolation and identification of *F. tularensis* isolates.

## ► Specimens

Sputum, pleural fluid, wounds, blood, lymph node biopsy samples, and gastric washings are the specimens collected for

culture, but isolation rate is very low. CSF may show a mild elevation of protein concentration or pleocytosis.

## ► Microscopy

Gram staining of the aspirates from ulcer exudates or from infected lymph nodes is not useful, because *F. tularensis* is extremely small and stains very faintly. Detection of antigen directly in clinical specimens by direct fluorescent antibody staining, using fluorescein-labeled antibodies directed against the organism, is more sensitive and specific method for diagnosis of the condition. The test is yet to be available for wide use.

## ► Culture

Blood cultures in specific medium (such as cysteine–glucose–blood agar) are usually negative unless the cultures are incubated for a week or longer. Aspirates of lymph nodes or draining sinuses are usually positive if the cultures are incubated for 3 days or longer. The identification of *F. tularensis* is confirmed by testing with specific antiserum containing antibodies against *Francisella*.

## ► Serodiagnosis

Diagnosis of tularemia is usually based on serology. Serodiagnosis depends on demonstration of serum antibodies by tularemia tube agglutination test and ELISA. Tularemia tube agglutination test is the most commonly used serological test. An agglutination titer greater than 1:160 is considered presumptively positive. Diagnosis is confirmed by a fourfold increase in titer of the serum samples collected 2 weeks apart. The test shows cross-reactivity with *Brucella* species, *Proteus* Ox-19, *Salmonella* species, and *Yersinia* species.

Capture ELISA using specific monoclonal antibodies raised against LPS of the virulent forms of *F. tularensis* is a sensitive method for detection of serum antigen.



## Molecular Diagnosis

PCR has been used to detect *F. tularensis* in clinical specimens even after start of antibiotic therapy. The test is yet to be available as routine test.

## Treatment

Streptomycin is the antibiotic of choice for treatment of tularemia. Gentamicin is used as an alternative to streptomycin. Fluoroquinolones are now increasingly used in treatment of tularemia. Tetracycline and chloramphenicol have been used, but treatments with these bacteriostatic agents have been associated with high rate of relapse.



## Prevention and Control

Avoidance of exposure to tick bites and to dead or wild mammals, if possible, prevents the disease. Frequent and thorough hand washing is also useful. For vaccine refer the box Vaccines.

Postexposure prophylaxis using tetracycline, ciprofloxacin, or doxycycline for 2 weeks is recommended within 24 hours of air-borne exposure.

### Vaccines

A live attenuated vaccine obtained from avirulent *F. tularensis* biovar *palaeartica* (type B) is available. The vaccine confers only partial protection but reduces the severity of disease in vaccinated people. It is recommended only for those people who are repeatedly exposed to the pathogen, such as laboratory workers, wild-animal veterinarians, and taxidermists.



### CASE STUDY

A 3-year-old child was brought to pediatric OPD with history of continuous dry cough for the past 15 days. On examination, episodes of continuous violent coughing and a typical “whoop” were found. Peripheral blood smear showed leukocytosis. Chest X-ray was normal. Gram stain showed presence of oral commensals. Ziehl–Neelsen stain from gastric aspirate was negative for acid-fast bacteria.

- What is the likely diagnosis?
- What are the likely complications of this condition?
- How will you diagnose the condition in laboratory?
- Which is the antibiotic of choice for the treatment of this case?
- What are the vaccines available for prevention of the condition?

# Brucella

## Introduction

Brucellosis is primarily a zoonotic infection caused by *Brucella* organisms infecting the domestic animals. The disease continues to be a major public health problem worldwide. The condition is known by various names, such as Malta fever, Mediterranean fever, undulant fever, etc.

## Brucella

### Classification

The genus *Brucella* consists of small, nonmotile, nonsporing, nontoxicogenic, nonfermenting aerobic, and Gram-negative coccobacilli. The bacteria can grow on a variety of culture media including serum dextrose, blood, and chocolate agar. They are strict parasites of domestic and wild animals, but they can infect humans, which are accidental hosts. The genus *Brucella* consists of seven species, four of which are human pathogens. These are *Brucella abortus*, *Brucella melitensis*, *Brucella suis*, and *Brucella canis* (Table 40-1). Human infections with *Brucella neotomae* and *Brucella ovis* have not been described. Moreover, each *Brucella* species has a characteristic predilection to infect certain animal species where it causes chronic disease that persists for life.

### Properties of the Bacteria

#### ► Morphology

*Brucella* shows the following features:

- Brucellae are Gram negative, but counterstain poorly and require relatively more time for staining.
- They are small coccobacilli, measuring  $0.5\text{--}0.7 \times 0.6\text{--}1.5 \mu\text{m}$  in size.
- These are arranged singly, sometimes in pairs, or in short chains. They do not produce spores, flagella, or capsule.

TABLE 40-1

#### Human infections caused by *Brucella* species

Bacteria	Diseases
<i>Brucella abortus</i>	Mild brucellosis with rare suppurative complications
<i>Brucella melitensis</i>	Severe acute brucellosis with many complications
<i>Brucella suis</i>	Chronic brucellosis with suppurative complications
<i>Brucella canis</i>	Mild brucellosis with rare suppurative complications

#### ► Culture

Brucellae are strict aerobes. Most biovars of *B. abortus* require 5–10% CO<sub>2</sub> for their growth. No growth occurs in aerobic conditions. They grow at a temperature range of 22–40°C (optimum temperature 37°C) and pH range of 6.6–7.4. Brucellae can grow on simple media, but their growth is slow and scanty. Growth is improved by addition of serum, blood, liver extract, and glucose. *Brucella* organisms grow best on trypticase soy based or other enriched media. Blood agar and trypticase soy agar are the media of choice. Tryptose agar, trypticase soy agar, serum potato infusion agar, and serum dextrose agar are the other media also used for culture of Brucellae. Addition of bacitracin, polymyxin, and cycloheximide to these media makes them selective. On these solid media, *Brucella* spp. produce small, moist, translucent, and glistening colonies after 3 or more days of incubation. In liquid media, growth is uniform.

#### ► Biochemical reactions

Brucella species show following biochemical properties:

- Brucellae are catalase and oxidase positive (except for *B. ovis* and *B. neotomae*, which are oxidase negative).
- They reduce nitrate to nitrite and have variable urease activity—*B. suis* becomes urease positive within 30 minutes, while *B. abortus* becomes positive within 1–2 hours.
- Some *Brucella* species produce H<sub>2</sub>S, while some species do not produce H<sub>2</sub>S.
- Citrate is not utilized.
- They do not produce indole and are MR and VP test negative.
- They do not ordinarily ferment any sugars.

*Brucella* species and biovars are differentiated by following characteristics (Table 40-2): (a) growth in the presence of aniline dyes, such as basic fuchsin dyes or thionine; (b) requirement for CO<sub>2</sub>; (c) ability to use glutamic acid, ornithine, lysine, and ribose; (d) ability to produce H<sub>2</sub>S; (e) agglutination by antisera against specific lipopolysaccharide (LPS); and (f) susceptibility to lysis by bacteriophage.

#### ► Biotypes

*B. abortus* consists of seven biotypes, *B. melitensis* three biotypes, and *B. suis* five biotypes. H<sub>2</sub>S-producing *B. suis* strains are called American strains, and those not producing H<sub>2</sub>S are called Danish strains.

TABLE 40-2 Differential features of *Brucella* species

Species	Animal reservoir	Biotypes	CO <sub>2</sub> requirement	H <sub>2</sub> S requirement	Urease production	Growth in presence of 20 µg/mL		
						Basic fuchsin		Thionine
						1:50,000	1:25,000	1:50,000
<i>Brucella melitensis</i>	Goats, Sheep	1	–	–	Variable	+	–	+
	Goats, Sheep	2	–	–	Variable	+	–	+
	Goats, Sheep	3	–	–	Variable	+	–	+
<i>Brucella abortus</i>	Cattle	1	+(–)	+	1–2 hours	+	–	–
	Cattle	2	+(–)	+	1–2 hours	–	–	–
	Cattle	3	+(–)	+	1–2 hours	+	+	+
	Cattle	4	+(–)	+	1–2 hours	+	–	–
	Cattle	5	–	–	1–2 hours	+	–	+
	Cattle	6	–	+(–)	1–2 hours	+	–	+
	Cattle	9	–	+	1–2 hours	+	–	+
<i>Brucella suis</i>	Swine	1	–	+	0–30 minutes	–	+	+
	Swine	2	–	–	0–30 minutes	–	–	+
	Swine	3	–	–	0–30 minutes	+	+	+
	Swine	4	–	–	0–30 minutes	+	+	+
	Swine	5	–	–	0–30 minutes	–	+	+
<i>Brucella canis</i>	Dogs		–	–	0–30 minutes	–	+	+

### ► Phage types

Tblisi (Tb) is the reference phage used for phage typing of *Brucella* species. This phage lyses *B. abortus* both at routine test dilution (RTD) and at 10,000 RTD. The phage lyses *B. suis* at 10,000 RTD only, but does not lyse any strain of *B. melitensis*.

### ► Other properties

**Susceptibility to physical and chemical agents:** The brucellae are rapidly killed at 60°C in 10 minutes; hence they are killed by pasteurization in the milk. They are also killed by disinfectants, such as 1% phenol in 15 minutes. They are sensitive to direct sunlight and acid. The bacteria survive for 10 days in refrigerated milk, for 1 month in ice cream, and for 4 months in butter. *B. melitensis* remains viable in urine for 6 days, in dust for 6 weeks, and in water or soil for 10 weeks.

## Cell Wall Components and Antigenic Structure

*Brucella* like any other Gram-negative bacterium contains LPS in the outer cell membrane of the cell walls. But, the LPS of *Brucella* is different both structurally and functionally from that of other Gram-negative bacteria. The LPS of *Brucella* shows the following unique characteristics:

1. The lipid A part of the LPS contains 16-carbon long fatty acids but lacks the 14-carbon myristic acid typical of lipid A of Enterobacteriaceae.
2. The polysaccharide O portion of LPS contains an unusual sugar, 4,6-dideoxy-4-formamido- $\alpha$ -D-mannopyranoside, which is expressed either as homopolymer of  $\alpha$ -1,2-linked

sugars (A type) or as 3- $\alpha$ -1,2- and 2- $\alpha$ -1,3-linked sugars (M type). On the basis of these O polysaccharide linkages, somatic antigens of *Brucella* are classified into two major types: antigen A and antigen M.

*B. abortus* has the highest concentration of A antigen (about 20 times as much as M antigen), while *B. melitensis* has the highest concentration of M antigen (about 20 times that of A antigen). *B. suis* has an intermediate antigenic pattern.

*Brucella* species show antigenic cross-reaction with *Salmonella* serotypes N (O: 30 antigen), *Escherichia coli* (O: 116, O: 157), *Vibrio cholerae*, *Pseudomonas multocida*, *Yersinia enterocolitica*, and *Francisella tularensis*.

Agglutination and other features of *Brucella* species are summarized in Table 40-3.

## Pathogenesis and Immunity

*Brucella* species have predilection for intracellular growth, hence may be demonstrated inside phagocytes. Intracellular location of the *Brucella* explains the relative resistance of the bacterium to chemotherapy.

### ► Virulence factors

LPS is the principle virulence factor of *Brucella* spp. Intracellular location of the bacteria makes them resistant to killing in serum and also by phagocytes (Table 40-4).

### ► Pathogenesis of brucellosis

Brucellosis is a systemic disease in humans that can involve almost any organ system. They enter through (a) abrasion or cut in the skin, (b) conjunctiva, (c) respiratory tract,

TABLE 40-3

### Agglutination and other features of *Brucella* species

Species	Biotypes	Agglutination by monospecific serum against			Lysis by phage	
		A	M	R	RTD	10,000 RTD
<i>Brucella melitensis</i>	1	–	+	–	–	–
	2	+	–	–	–	–
	3	+	+	–	–	–
<i>Brucella abortus</i>	1	+	–	–	+	+
	2	+	–	–	+	+
	3	+	–	–	+	+
	4	–	+	–	+	+
	5	–	+	–	+	+
	6	+	–	–	+	+
<i>Brucella suis</i>	1	+	–	–	–	+
	2	+	–	–	–	+
	3	+	–	–	–	+
	4	+	+	–	–	+
	5	–	+	–	–	+
<i>Brucella canis</i>		–	–	+	–	–
<i>Brucella ovis</i>		–	–	+	–	–
<i>Brucella neotomae</i>		+	–	–	–	+

TABLE 40-4

### Virulence factors of *Brucella* species

Virulence factors	Biological functions
LPS	Facilitates intracellular survival of the bacteria by inhibiting polymorphonuclear degranulation
Intracellular location of the bacterium	Makes it resistant to killing in serum and also by phagocytes

and (d) gastrointestinal tract. Shortly after gaining entry to the body, brucellae are rapidly ingested by polymorphonuclear leukocytes, which are attracted to the site of inflammation. But inside the leukocytes, the brucellae are not killed due to the presence of enzyme superoxide dismutase, O polysaccharide of LPS, and nucleotide-like substances produced by the bacteria. Brucellae that are not killed by leukocytes spread from the site of infection to the local lymph nodes which drain the site of infection. Inside the lymph glands, the bacteria multiply and are released to the blood stream following rupture of the cells and are phagocytosed by the macrophages.

Bacteria present in the macrophages are then carried to the organs of reticuloendothelial system, such as liver, spleen, bone marrow, lymph nodes, and kidney. In these organs, brucellae

multiply in phagosomes of macrophages due to production of adenine and guanine monophosphate, which inhibits the phagolysosome fusion, oxidative burst activity, and tumor necrosis factor production.

Apart from the organs of reticuloendothelial system, any other organ system (central nervous system, heart, joints, genitourinary system, pulmonary system, and skin) can be involved in brucellosis.

### Host immunity

Immunity in brucellosis, like other obligate intracellular pathogens, is primarily cell-mediated immunity. Activated macrophages are primarily responsible for killing the bacteria by producing interferon gamma and other cytokines. It is suggested that antibody, complement, and macrophage-activating cytokines also play a supportive role in controlling multiplication of extracellular bacteria or in early infection. The humoral immunity is characterized by production of antibodies against LPS of the bacteria. However, even in the presence of opsonic activity, these serum antibodies against LPS do not provide any protective immunity against bacteria.

### Clinical Syndromes

*Brucella* species cause brucellosis. Clinical manifestations of brucellosis are protean in nature, and the course of disease is variable. The clinical manifestations of brucellosis depend on the infecting *Brucella* species. Of the four *Brucella* species causing human infections, *B. melitensis* is the most virulent species. It causes the most severe and acute cases of brucellosis. It is also the most common cause of brucellosis. Because *B. melitensis* can survive in phagocytic cells and multiply in them, it produces a large number of bacteria.

*B. suis* is associated with a prolonged course of illness often with suppurative, destructive lesions. *B. abortus* causes mild to moderate sporadic disease that is rarely associated with complications. *B. canis* infection is associated with an insidious onset, more relapses. This species usually do not cause chronic disease.

### Brucellosis

The incubation period may range from 3 days to several weeks. Human infections may be of three types, as follows: (a) acute brucellosis, (b) chronic brucellosis, and (c) localized infection.

**Acute brucellosis:** Acute brucellosis is seen in approximately 50% of patients infected with *Brucella*. Patients usually complain of nonspecific symptoms, such as anorexia, fatigue, weakness, malaise, or joint pain. Fever is an important symptom and is seen in almost all patients. The fever is intermittent and undulant (hence known as undulant fever) and can be associated with a relative bradycardia. In untreated patients with adverse disease, the patients can show respiratory tract symptoms (20%), bone and joint symptoms (20–60%), neuropsychiatric symptoms, and gastrointestinal tract symptoms.

**Chronic brucellosis:** This condition develops in incompletely treated patients. This condition is associated with a low-grade nonbacteremic infection with periodic exacerbations.

Symptoms often last for 3–6 months and occasionally for a year or more.

**Localized infection:** *B. suis* is more likely to cause localized and suppurative infection. Complications include infections of the heart, central nervous system (CNS), and the skin. Brucella endocarditis is the most dangerous complication and is responsible for 80% of deaths in brucellosis. Chronic meningoencephalitis is the usual manifestation of CNS infection.

## Epidemiology

### Geographical distribution

*Brucella* infection is worldwide in distribution. The condition is endemic in certain Mediterranean countries. More than 500,000 cases of brucellosis are reported annually. Different *Brucella* species cause human infection in different geographical areas. *B. melitensis* is the major species causing human infection in India. In the United States, *B. suis* is the major species responsible for infection, whereas in Great Britain, *B. abortus* is the important species responsible for infection.

### Habitat

*Brucella* species are primarily obligate intracellular pathogens of the reticuloendothelial system, such as lymph nodes, liver, spleen, and bone marrow.

### Reservoir, source, and transmission of infection

*Brucella* species cause infection in a wide range of hosts, but these species show a high degree of host specificity. *B. melitensis* infects goats and sheep; *B. abortus*, cattle; *B. suis*, swines; and *B. canis*, dogs and foxes. The infected animals, such as cattle, goats, sheep, buffalos, and swine are the important reservoirs of infections.

The incidence of human disease is very closely related to the prevalence of infections in cattle, goats, and sheep. This is also related to activities that allow exposure of humans to potentially infected animals or their products.

Human brucellosis is primarily a zoonotic bacterial infection. The infection is acquired always from animals directly or indirectly. *Brucella* organism is transmitted to humans by the following ways (Fig. 40-1): (a) ingestion, (b) direct contact, (c) inhalation, and (d) accidental inoculation.

**1. Ingestion:** Brucellosis results primarily by drinking contaminated unpasteurized milk or milk products. The infection can also be transmitted by drinking water or eating raw vegetables contaminated with feces or urine of infected animals and also by eating meat of infected animals.

**2. Direct contact:** The infection is acquired by direct contact with the infected materials of septic abortion of the animals or at the time of slaughter of animals. *Brucella* species present in the infected materials (placenta, fetuses, vaginal discharge, urine, or infected carcasses) enter the human host through the mucosa, conjunctiva, or skin.

**3. Inhalation:** The infection is transmitted by inhalation of dust from wool or other dried material of infected animals. Infection by inhalation is important among veterinarians and laboratory workers.

**4. Accidental inoculation:** Accidental inoculation is a serious risk in laboratory workers who handle culture of the organism. The incidence of infection in laboratory workers is reported in the countries of the Middle East and also in the United States, China, Peru, Mexico, and India.

## Laboratory Diagnosis

Clinical diagnosis of brucellosis is very difficult due to protean manifestation of the disease. Hence, laboratory diagnosis plays an important role in confirming the diagnosis of brucellosis.

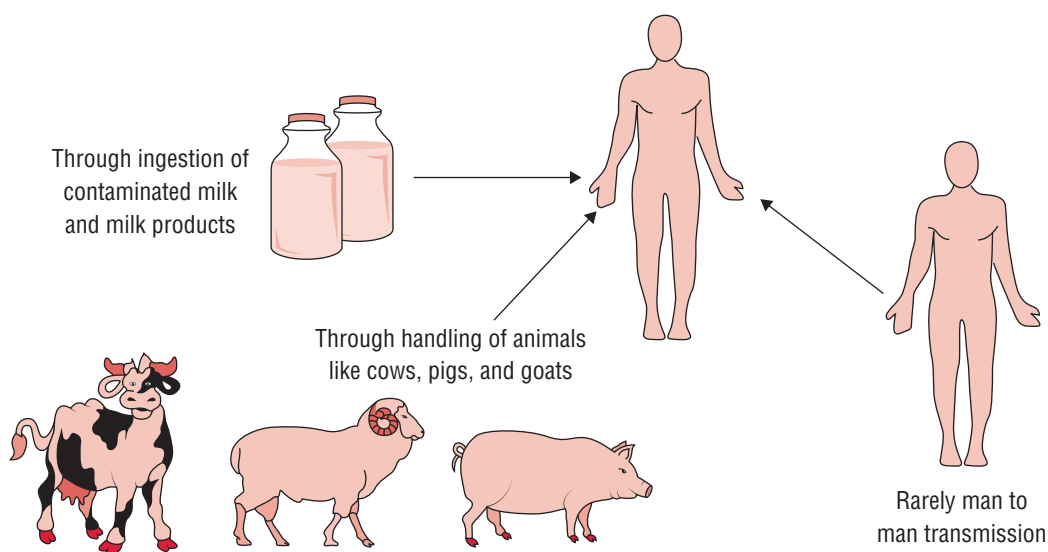

FIG. 40-1. Transmission of brucellosis.

## ► Specimens

Blood is the specimen of choice and is collected for culture and for serological test. Bone marrow and sometimes synovial fluid and pleural fluid are also collected for culture. Specimens such as liver and lymph nodes can also be cultured for isolation of *Brucella* organisms. Rarely, the bacteria can be isolated from cerebrospinal fluid (CSF), urine, sputum, breast milk, vaginal discharge, and seminal fluid.

## ► Microscopy

Gram staining is not useful for demonstration of *Brucella* organisms in clinical specimens due to their small size and intracellular location.

## ► Culture

Isolation of *Brucella* from blood and other clinical specimens is the definitive diagnostic procedure in brucellosis. Approximately, 5–10 mL of blood is collected in the 200 mL serum dextrose broth or trypticase soy broth and incubated at 37°C under 5–10% of CO<sub>2</sub>. After fourth day of incubation, subcultures are made on solid media, every 3–5 days for 8 weeks before declaring the culture as negative.

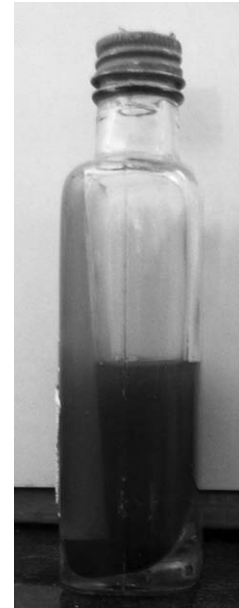

FIG. 40-2. Biphasic medium.

### Key Points

**Castaneda's method of blood culture:** A useful method to culture blood without the need for frequent subculture on solid medium, hence possibilities of contamination can be avoided. This biphasic medium contains both trypticase soy broth and solid trypticase soy agar slant in the same bottle (Fig. 40-2). The blood is inoculated onto the liquid broth, and bottle is incubated in the upright position. For subculture, one does not have to open the bottle; instead, the bottle is tilted so that liquid broth flows over the solid medium slant. It is again incubated in the upright position. In case of positive blood culture, colonies appear on the slant.

The Castaneda's method of blood culture also reduces the risk of laboratory-acquired infection to both medical and paramedical staff. Sensitivity of blood cultures ranges from 30% to 50% depending on the *Brucella* species isolated. *B. melitensis* and *B. suis* are more likely to have detectable bacteremia and hence are readily cultured than *B. abortus*.

Bone marrow cultures are more sensitive than blood culture. They typically are positive in the negative blood culture and serological results. Synovial fluid culture is positive in 50% of patients.

## ► Identification of bacteria

Identification of *Brucella* colonies is made by microscopy of Gram-stained smears of the colonies, colony morphology, biochemical tests, and reactivity with specific antibrucella sera (Box 40-1).

## ► Serodiagnosis

Serological tests are useful for diagnosis of subclinical brucellosis and for cases of acute and chronic brucellosis by

### Box 40-1

### Identifying features of *Brucella* spp.

1. Small, Gram-negative coccobacilli.
2. Slow growers; produce small, moist, translucent, and glistening colonies after 3 or more days.
3. Growth in the presence of aniline dyes, such as basic fuchsin dyes or thionine.
4. Ability to use glutamic acid, ornithine, lysine and ribose, and to produce H<sub>2</sub>S.
5. Oxidase positive.
6. Agglutination with specific antibrucella sera.
7. Susceptibility to lysis by bacteriophage.

demonstration of specific antibodies in patient's serum. Specific brucella antibodies, both IgG and IgM antibodies, appear in the serum 7–10 days after infection. IgM antibodies persist for up to 3 months after which these antibodies decline. Then IgG and IgA antibodies appear after 3 weeks of infection and persist for longer time. Hence, in acute stage or subclinical brucellosis, both IgG and IgM can be demonstrated; in chronic brucellosis, only IgG can be demonstrated, as IgM are absent.

As IgG antibodies persist for many months or years, demonstration of significant rise in the antibody titer is the definitive serological evidence of brucellosis. A fourfold increase in the titer or a single high antibody titer of 1:160 is the presumptive evidence of *Brucella* infection.

*B. abortus* is used as an antigen in brucella agglutination tests because the antibodies against *B. melitensis* or *B. suis* can cross-react with *B. abortus* antigen. *B. abortus* antigen not only detects specific antibodies against its own antigens but also detects antibodies produced against *B. melitensis* and *B. suis*. However, antibodies against *B. abortus* do not react with *B. canis*. Hence, specific *B. canis* antigen is used to detect antibodies in the serum of patients infected with this organism.

A number of serological tests have been developed and tested in serodiagnosis of brucellosis. Common methods are (a) standard tube agglutination tests, (b) indirect immunofluorescent tests, and (c) enzyme-linked immunosorbent assay (ELISA).

**Standard tube agglutination test:** This test remains the standard method and is the most commonly used serological test for diagnosis of brucellosis. It detects the presence of antibodies against LPS component of *Brucella*. The test uses killed strains of *B. abortus* as antigen and is useful for diagnosis of brucellosis caused by *B. abortus*, *B. melitensis*, and *B. suis*. This test is not useful for the infection caused by *B. canis* because this bacterium does not have O polysaccharide on its surface; hence it does not produce antibodies against LPS.

The tube agglutination test is considered positive when antibody titers are greater than or equal to 1 in 160 or when a four-fold rise titer is demonstrated in convalescent sera. Rise in titer is especially important in patients coming from endemic area in which titers of 1 in 160 are not unusual in persons who are asymptomatic.

**Modified tube agglutination test:** In this test, 2-mercaptoethanol is added to the patient's sera before testing it. Addition of mercaptoethanol causes disruption of disulfide bond of IgM; hence only IgG is detected. This modified tube agglutination test is useful for specific detection of IgG antibodies, and titers higher than 1:80 are suggestive of active infection. A high IgG antibody titer or a titer that is higher after treatment suggests relapse or persistent infection. This test is useful for diagnosis of brucellosis during convalescence.

**Indirect immunofluorescent assay:** It is a sensitive method for detection of brucella antibodies in the serum, which may be positive even in agglutination-test-negative cases.

**Enzyme-linked immunosorbent assay:** ELISA is the most sensitive test for detection of IgM, IgA, and IgG brucella antibodies during acute and chronic brucellosis. In this test, LPS-depleted cytoplasmic protein antigen of *Brucella* is used as antigen. Use of this antigen allows accurate evaluation of relapse of brucellosis in a patient because LPS antigenemia persists for a longer duration than does protein antigen.

ELISA is extremely useful for diagnosis of neurobrucellosis by demonstration of brucella antibodies in the CSF.

Nevertheless, these serological tests may show erroneous results due to the following factors:

1. **Blocking antibodies:** Blocking or nonagglutinating antibodies in the serum may contribute to a false positive result. This can be avoided by heating the serum at 55°C for 30 minutes or by using 4% saline or diluent in the test. These blocking antibodies can be diluted by adding antihuman globulin to the antigen serum mixture (Coombs' test).
2. **Prozone phenomenon:** It is a frequent problem in diagnosis of brucellosis. This occurs due to high level of brucella antibodies in the serum, caused by hyperantigenemia. Prozone phenomenon gives rise to a false negative test. This can be avoided by routine dilution of serum to at least 1:320 because inhibition of agglutination may occur at low dilution.

3. **Cross-reactivity with *V. cholerae*, *Y. enterocolitica* serotype O9, *F. tularensis*, and *Salmonella* species** can cause false positive results due to the presence of cross-reacting LPS in these organisms. Cholera-induced antibodies may be removed by 2-mercaptoethanol absorption.
4. A decrease in titer is observed with recovery of patient.

**Brucella skin test:** Brucella skin test is a delayed type of hypersensitivity reaction to brucella antigen. In this test, brucellin, a protein extract of the bacteria, is used as an antigen and is administered intradermally. The presence of erythema and induration of 6 mm or more within 24 hours is suggestive of positive reaction. This test is positive only in chronic brucellosis but negative in acute brucellosis. Repeated negative skin test excludes brucellosis.



**Molecular Diagnosis**

PCR has been evaluated for detection and rapid diagnosis of *Brucella* species. The test still remains at experimental stage.

### Other tests

Bone marrow examination shows erythrophagocytosis, and CSF cultures for neurobrucellosis show pleocytosis, increased protein level, and hypoglycorrhea. Anemia in 75% of patients, thrombocytopenia in 40%, and pancytopenia in 6% of patients are other features.

### Laboratory diagnosis in animals

The diagnosis of brucellosis in animals is based essentially on the same method as that employed for the diagnosis of human infections. In addition, culture of milk and urine from infected animals may give positive results. Rapid latex agglutination test and Rose Bengal card test are the rapid diagnostic methods, and are also used for diagnosis of brucellosis in cattle population.

**Milk ring test:** This is a frequently used serological test for demonstration of antibodies in the milk of an animal. This is a screening test used to detect the presence of *Brucella* infection in infected cattle. In this test, a concentrated suspension of killed *B. abortus* or *B. melitensis* stained with hematoxylin is used as antigen. This test is performed by adding a drop of colored brucella antigen to a sample of whole milk in a test tube. Then it is mixed, and mixed suspension is incubated in water bath at 70°C for 40–50 minutes. In a positive test, if antibodies are present in the milk, the bacilli are agglutinated and raised with the cream to form a blue ring at the top, leaving the milk unstained. In a negative test, the milk remains uniformly blue without formation of any colored ring.

### Treatment

Brucellae are sensitive to a number of oral antibiotics and aminoglycosides. The combination of tetracycline and doxycycline

is effective against most species of *Brucella*. Relapse is common on therapy with a single drug. So, the combination of antibiotics is recommended whenever possible. Combination of doxycycline with rifampin is effective. Doxycycline given in a dosage of 200 mg/day orally with the addition of streptomycin in a dosage of 1 g/day given intramuscularly for 2–3 weeks is most effective for treatment of most forms of brucellosis in adults.

Most of the patients respond to a 6-week course of therapy with a combination of rifampin and doxycycline given orally. Only less than 10% of patients show relapse. A dosage of doxycycline for 6 weeks with combination of streptomycin for the first 3 weeks is also effective. Relapse in brucellosis is due to inadequate therapy and not due to development of resistance to antibiotics.

## Prevention and Control

Pasteurization or boiling of milk is most important to prevent transmission of brucellosis in humans, as most of the human infections are acquired by ingestion of contaminated milk and milk products. Also, use of protective clothing and gloves by persons handling or coming into close contact with animals prevents transmission of infection. For vaccination refer the box Vaccines.

### Vaccines

Vaccination of animals is effective to control brucellosis in animals. Live attenuated *B. abortus* vaccine containing *B. abortus* 1019 strain has been used successfully to prevent infection in cattle. Vaccines are not available against either *B. suis* or *B. canis*. No vaccine is available for humans.



### CASE STUDY

A 54-year-old male patient attended Medicine OPD, with a history of fever, headache, low back pain, joint pain for 1 month. History revealed that he was a shepherd by profession and was in habit of consuming unboiled milk. The patient was admitted and investigated thoroughly. WBC count was raised. ESR (erythrocyte sedimentation rate) was raised; Widal test was negative. The serum was negative for HIV antibodies by ELISA. Peripheral blood smear for malaria parasite was negative. The blood culture yielded *Brucella abortus*.

- Diagnose the condition.
- What are the serological tests available for diagnosis of the condition?
- What are the reservoirs of the infection and how the infection is transmitted to humans?
- How will you treat the condition?
- Is there any vaccine against the disease for human use?



# *Mycobacterium tuberculosis*

## Introduction

The genus *Mycobacterium* included in the family Mycobacteriaceae consists of nonmotile, non-spore-forming, and aerobic bacilli. They are slightly curved rods, sometimes showing filamentous and branching forms. In liquid medium, they form mould-like pellicle; hence, the name *Mycobacterium* is derived from the word “mould” meaning fungus-like bacterium.

The cell wall is thick, complex, and rich in lipids, which makes the surface hydrophobic. The lipid-rich cell wall also makes the bacteria resistant to commonly used disinfectants and laboratory staining reagents. Because of their lipid-rich waxy cell wall, mycobacteria are difficult to stain. But once stained, they resist decolorization with acid solution and alcohol. They are, therefore, called acid-fast bacilli (AFB). Although they are Gram positive, they are difficult to stain, and they stain poorly with Gram stain.

Most mycobacteria are slow growers, the generation time being 2–24 hours. These bacteria require 3–8 weeks of incubation to produce demonstrable colonies on the solid media.

## Classification

The genus *Mycobacterium* contains more than 70 species, many of which cause disease in humans. *Mycobacterium* species causing most human infections are summarized in Table 41-1. *Mycobacterium leprae* was the first species of the genus *Mycobacterium* to be identified by Hansen in 1874. Furthermore, Robert Koch in 1882 isolated the mammalian tubercle bacillus and established its role as a causative agent of tuberculosis, as it satisfied all the criteria of Koch’s postulates. Subsequently, *Mycobacterium tuberculosis* was demonstrated as the causative agent of tuberculosis.

*Mycobacterium tuberculosis* complex is the term used currently, which includes four species that can cause tuberculosis in humans and other mammals. These are:

- *M. tuberculosis*, the human type;
- *Mycobacterium bovis*, bovine type;
- *Mycobacterium africanum*, a species intermediate between human and bovine type and causing human tuberculosis mostly in tropical Africa; and
- *Mycobacterium microti*, another species which is pathogenic for goats and other small animals but does not cause any human infection.

Saprophytic mycobacteria are the third group of mycobacterial species isolated from different types of sources. This species has been isolated from cold- and warm-blooded animals, from skin ulcers, and from environmental sources, such as soil and water. Originally, these saprophytic mycobacteria were called atypical environmental or opportunistic mycobacteria, but these species are now designated as mycobacteria other than typical tubercle (MOTT). This group of saprophytic mycobacteria are described in detail in Chapter 42.

## General Properties

Members belonging to the genus *Mycobacterium* show the following characteristics:

- They are acid fast.
- They contain mycolic acid, which consists of 60–90 carbons that are splitted to produce fatty acid methyl esters.
- They contain a high (61–71%) guanine and cytosine content in the DNA.

**The cell wall of *Mycobacterium*:** The cell wall of *Mycobacterium* is complex. It is typical as that of Gram-positive

TABLE 41-1

Human infections caused by most common *Mycobacterium* species

Bacteria	Diseases
<i>Mycobacterium tuberculosis</i>	Tuberculosis
<i>Mycobacterium leprae</i>	Leprosy
<i>Mycobacterium avium</i> complex	Opportunistic mycobacterial infections (pulmonary disease lymphadenopathy, disseminated disease)
<i>Mycobacterium kansasii</i>	Opportunistic mycobacterial infections (pulmonary disease)
<i>Mycobacterium fortuitum</i>	Opportunistic mycobacterial infections (post-trauma abscess)
<i>Mycobacterium chelonae</i>	Opportunistic mycobacterial infections (post-trauma abscess)
<i>Mycobacterium abscessus</i>	Opportunistic mycobacterial infections (skin infection)

bacteria. It contains unique cytoplasmic membrane, surrounded by a thick peptidoglycan and a layer of highly antigenic mycolic acid. It is thick and lipid rich. The complex cell wall confers many properties to the bacteria. The mycolic acid consists of peptidoglycolipids, glycolipids, and lipids. These account for nearly 60% of dry weight of the cell wall. The outer layer consists of peptic chains and is an important antigen of the bacteria, which induces cellular immunity in infected patients. A purified protein derivative (PPD) of this layer is used as a source of antigen in the skin test to demonstrate hypersensitive reaction of the host to *M. tuberculosis*.

## *Mycobacterium tuberculosis*

*M. tuberculosis* is the causative agent of tuberculosis—number one infectious killer disease worldwide. Tuberculosis is most common in Southeast Asia, Sub-Saharan Africa, and Eastern Europe. According to WHO, more than 8 million new cases of tuberculosis occur every year.

### Properties of the Bacteria

#### ► Morphology

*M. tuberculosis* shows following morphological features:

- *M. tuberculosis* organisms are straight or slightly curved rods occurring singly, in pairs, or in small clumps.
- They measure about  $3 \times 0.3 \mu\text{m}$  in size; sometimes long filamentous forms are also seen. *M. bovis* is usually shorter and stouter than *M. tuberculosis*.
- They are Gram positive but are difficult to stain. They stain poorly with Gram staining.
- They are nonmotile, nonsporing, and noncapsulated.

**Acid fastness of bacteria:** *M. tuberculosis* is acid fast and alcohol fast; it resists decolorization by 20% sulfuric acid and absolute alcohol. This acid-fast staining is the most important property of the bacteria and is used widely for identification of the bacteria.

Ziehl–Neelsen (ZN)-staining procedure is used to demonstrate acid fastness of the bacteria. With this stain, *M. tuberculosis* stains bright red, while the tissue cells and other organisms are stained blue. These bacilli can also be stained by Auramine O stain and examined under a fluorescent microscope. They appear as bright fluorescent rods against a dark background.

Much's granules are non-acid-fast form of tubercle bacilli demonstrated in the cold abscess pus, which when injected into susceptible animals could produce the disease.

#### ► Culture

*M. tuberculosis* is an obligate aerobe and characteristically grows very slowly in media. Optimum temperature is  $37^\circ\text{C}$ , and the bacteria do not grow below  $25^\circ\text{C}$  or above  $40^\circ\text{C}$ . Optimum pH is 6.4–7.0. *M. bovis* is microaerophilic on primary isolation, which subsequently becomes aerobic on subculture.

*M. tuberculosis* is a slow-growing bacillus with an average generation time of 14–15 hours. Prolonged incubation is therefore necessary for demonstrating growth of the bacteria. The colonies usually appear in almost 2 weeks, but sometimes require incubation up to 8 weeks to appear. *M. tuberculosis* can grow on a wide range of enriched solid and liquid media.

**1. Culture on solid media:** The examples of solid media are (i) egg-containing media (Lowenstein–Jensen [LJ] medium, Petraghani and Dorset egg medium); (ii) blood-containing media (Tarshis medium), serum-combining media (Loeffler's serum slope), or (iii) potato-based media (Pawlawsky medium). On these media, *M. tuberculosis* produces dry, rough, raised, and irregular colonies with a wrinkled surface.

- **LJ medium:** Of these media, LJ medium without starch is most widely used and is also recommended by the International Union against Tuberculosis (IUAT). The LJ medium consists of coagulated whole egg, asparagines, malachite green, mineral salt, and glycerol or sodium pyruvate. Malachite green inhibits growth of bacteria other than mycobacterium. Addition of 0.75% glycerol enhances growth of *M. tuberculosis*, but is inhibitory to growth of *M. bovis*. On the LJ medium after 6–8 weeks of incubation, *M. tuberculosis* produces yellowish or buff-colored colonies. They are tenacious and not easily emulsified (Fig. 41-1).

**2. Culture in liquid media:** The commonly used liquid media include Soloac's solutions, Dubos medium, and Middlebrook's and Beck's medium. In liquid media, *M. tuberculosis* produces growth that appears first at the bottom and then grips up to the sides and produces a surface pellicle that may extend along the sides above the medium. The bacteria in Dubos medium containing Tween 80 produce a diffuse growth. In glycerol broth, they form a whitish wrinkled pellicle on the surface and a granular deposit at the bottom. Virulent strains usually form long serpentine cords in liquid media. In contrast, avirulent strains produce a relatively dispersed growth in the medium. The liquid media are not used for routine culture of the bacilli.



**FIG. 41-1.** LJ media for growth of *Mycobacterium tuberculosis*: one medium showing colonies of *M. tuberculosis*, while the other medium showing no growth.

They are usually used for (i) preparation of mycobacterial antigens for vaccines and (ii) to assess antibiotic sensitivity of *M. tuberculosis*.

### ► Biochemical reactions

*M. tuberculosis* shows the following biochemical properties:

- Niacin test is an important test to identify niacin-positive human strains of *M. tuberculosis* and differentiate them from niacin-negative *M. bovis* strains. *M. tuberculosis* human strains are niacin test positive. *M. simiae* and a few strains of *M. chelonae* are also niacin positive. They produce niacin as a metabolic by-product when grown on an egg-containing solid medium.
- *M. tuberculosis* is usually catalase positive. They lose their catalase activity when they become resistant to isoniazid (INH). Catalase-negative strains of *M. tuberculosis* are not virulent for guinea pigs.
- *M. tuberculosis* is amidase positive. It produces amidase enzymes, such as nicotinamidase and pyrazinamidase, which split various amide substrates.
- *M. tuberculosis* is positive for nitrate reduction test. It produces the enzyme nitrate reductase, thereby reducing nitrate to nitrite. *M. bovis* and *M. avium* lack the enzyme nitroreductase and therefore are negative for nitrate reduction test.
- *M. tuberculosis* as well as *M. bovis* are neutral red test positive. They have the property to bind neutral red in alkaline buffer solution.
- *M. tuberculosis* is arylsulfate test negative.

Differential features of various strains of *M. tuberculosis* are summarized in Table 41-2.

### ► Other properties

**Susceptibility to physical and chemical agents:** Mycobacteria are killed by heating at 60°C for 15–20 minutes. Killing of the bacteria is dependent on the nature of the clinical specimen in which the bacteria are present. Mycobacteria in the sputum may survive for 20–30 hours, but in dried sputum protected from the sunlight they may survive longer, up to 6 months. In droplet nuclei, they may remain alive for 8–10 days. Bacteria are killed when exposed to direct sunlight for 2 hours, but they remain viable at room temperature for 6–8 months.

Tubercle bacilli are sensitive to formaldehyde and glutaraldehyde. They are destroyed by tincture of iodine in 5 minutes and by 80% ethanol in 2–10 minutes. They are generally more resistant to chemical disinfectants than other nonspore-forming bacilli. They can survive exposure to 5% phenol, 15% sulfuric acid, 3% nitric acid, 5% oxalic acid, and 4% sodium hydroxide.

*M. tuberculosis* is susceptible to pyrazinamide, while *M. bovis* and other mycobacteria are resistant. *M. tuberculosis* is resistant to thiophene-2-carboxylic acid hydrazide (TCH), while *M. bovis* is susceptible.

### Cell Wall Components and Antigenic Structure

The cell wall of *M. tuberculosis* consists of four layers—(i) peptidoglycan layer, (ii) arabinogalactan layer, (iii) mycolic acid layer, and (iv) mycosides. The peptidoglycan layer is the innermost layer covalently linked with arabinogalactan (polysaccharide) and its terminal ends are linked to mycolic acid. This layer is overlaid with polypeptides and a layer of mycolic acid consisting of free lipids, glycolipids, and peptidoglycolipids. These lipids constitute nearly 60% of the dry weight of the cell wall.

The peptide chains present in the outer layer are important antigens, which stimulate cell-mediated immunity (CMI) in infected humans. PPDs are extracted and partially purified preparation of these proteins, which are used as antigens in tuberculosis skin test. The mycolic acid fraction of the lipids of the cell wall is responsible for many of the characteristic properties of the bacilli. These include (a) acid fastness, (b) slow growth by delaying permeation of nutrients, (c) resistance to commonly used antibiotics, (d) resistance to detergents, (e) unusual resistance to killing by acids and alkalis, and (f) clumping or cord formation.

### ► Antigenic structure

*M. tuberculosis* strains are antigenically homogenous. They are antigenically similar to *M. bovis* and *M. microti* but are distinct from other species. Mycobacteria possess two types of antigens: (a) cell wall insoluble polysaccharide antigens and (b) cytoplasmic soluble protein antigens. Group specificity is due to polysaccharides present in the cell wall. These include arabinogalactans, lipoarabinomannan, and also lipids, glycolipids, and peptidoglycolipids. Type specificity is conferred by

TABLE 41-2

Differential features of various strains of *Mycobacterium tuberculosis*

Properties	Human	Bovine	Asian	African
Oxygen requirement	Aerobic	Microaerophilic	Aerobic	Microaerophilic
Growth in thiophene-2-carboxylic acid hydrazide (TCH) (5 mg/L)	+	–	–	–
Niacin	+	–	+	Variable
Nitrate reduction	+	–	+	Variable
Phage type	A, B, C	A	I	A

the cytoplasmic protein antigens. These include antigen 5, antigen 6, antigen 14, antigen 19, antigen 33, antigen 38, and antigen 60.

### Key Points

- Mycobacteria protein (*tuberculin*) is responsible for development of delayed hypersensitivity in humans following infection by mycobacteria.
- Tuberculin from human, bovine, and murine bacilli are antigenically similar.
- Tuberculin also shows some antigenic relationship with that of atypical mycobacterium.

## Pathogenesis and Immunity

*M. tuberculosis* causes tuberculosis, a classic mycobacterial disease in humans. The capability of *M. tuberculosis* for intracellular growth in alveolar macrophages is the main determinant of virulence of the bacteria.

### ► Virulence factors

The factors determining the virulence of *M. tuberculosis* are poorly understood. *M. tuberculosis* does not produce any toxin. Although cord factor and sulfolipids are toxic substances produced by mycobacterium, their existence as virulence factors is doubtful.

**Cord factor:** Cord factor was so called because of the false belief that it is responsible for producing serpentine cords typically found on the surface of liquid or on solid media by *M. tuberculosis*. The cord factor was originally thought to be a virulent factor, which no longer holds true.

**Sulfolipids:** Sulfolipids are of doubtful virulence factor. Their exact role in pathogenesis of the disease is not known. They are found to be associated with virulence of tubercle bacilli by preventing fusion of phagosome and lysosome inside the macrophages, thereby allowing the bacteria to multiply within the macrophages. The main pathology in the infected tissue caused by mycobacterial infection is primarily due to responses of the host to *M. tuberculosis* infection rather than any virulence factor produced by it.

### ► Pathogenesis of tuberculosis

Tuberculosis may be primary or postprimary depending on the time of infection and the type of host immune response.

**Primary tuberculosis:** Primary tuberculosis represents the initial infection caused by *M. tuberculosis* in an infected host. This condition is usually seen in young children in endemic countries like India. On inhalation of the aerosolized bacteria, the bacilli reach the lower respiratory tract. Majority of the inhaled bacteria are killed by the natural defensive mechanisms of the upper respiratory tract. The bacilli that survive these defensive mechanisms reach the lungs and enter alveolar macrophages. The phagocytosed bacilli inhibit acidification of the phagosomes and prevent subsequent fusion of phagosome and lysosome. This makes the

bacteria multiply freely either in the phagosome or in the cytoplasm. Multiplication inside the cells leads to destruction of the cells and release of mycobacteria. This is followed by further cycles of phagocytosis of bacteria by macrophages, multiplication of mycobacteria, and lysis of macrophages.

Some bacilli are transported by macrophages to the hilar lymph nodes. They are attracted to this site by the presence of bacilli, cellular components, and chemotactic factors, such as complement C5a of the serum. This leads to formation of the focus known as *Ghon's focus*, which is formed of multinucleated giant cells known as *Langerhans cells*. The focus is commonly found in the lower lobe or in the lower part of the upper lobe of the lungs. This focus is also associated with enlargement of the hilar lymph nodes. Both Ghon focus and enlarged lymph nodes constitute the *primary complex*, which usually develops in 3–8 weeks after infection by tubercle bacilli. This primary complex is associated with the development of tuberculin hypersensitivity. The lesion in majority of cases heals spontaneously within 2–6 months.

If small numbers of bacilli are present, the bacilli are destroyed by macrophages with minimal tissue damage. However, if many bacilli are present, it leads to development of tissue necrosis. Multiple host factors contribute to the process of tissue necrosis. These include (a) local activation of the complement, (b) exposure to macrophage-derived hydrolytic enzymes, (c) cytokine toxicity, and (d) reactive oxygen intermediates.

The bacilli may be present as dormant in this stage or may become reactivated in old age, or following therapy, or following immunosuppressive disease. Reactivation of the site causes postprimary (secondary) tuberculosis.

**Postprimary (secondary) tuberculosis:** Postprimary tuberculosis is caused either by reactivation of latent infection or by exogenous reinfection. Reactivation of primary lesion occurs more commonly in patients with decreased immunity, such as patients receiving transplants, those infected with human immunodeficiency virus (HIV), and in the elderly patients. The secondary tuberculosis differs from primary tuberculosis in the following features:

1. Granulomas of secondary tuberculosis occur more commonly in the upper lobes of the lung. The lesions in the lungs undergo caseous necrosis and tissue destruction, resulting in the formation of the cavities in the immunodeficient hosts. The lesions disseminate widely into lungs and other organs, such as kidneys, bones, meninges, etc.
2. Involvement of lymph nodes is usual.
3. The cavities may rupture into blood vessels, causing dissemination of mycobacteria in the body or these may rupture into airways, releasing mycobacterium in aerosol and sputum.

**Tubercle:** Tubercle is the key pathology in tuberculosis. This is an avascular granulomatous condition. It is composed of a peripheral zone of lymphocytes and fibroblasts and a central zone consisting of giant cells with or without caseation. The lesions are mainly of two types: (a) exudative and (b) productive tubercular lesions.

- **Exudative tuberculous lesion** is an acute inflammatory reaction. This condition is associated with an increase in the number of polymorphonuclear leukocytes and subsequently with that of lymphocytes and mononuclear cells as well as accumulation of fluid. This lesion is seen more commonly in patients (i) infected with more virulent bacilli, (ii) with an increased load of bacilli, and (iii) with increased delayed type hypersensitivity (DTH) host response.
- **Productive tuberculosis lesion** is primarily cellular. It is associated with protective immunity rather than DTH response.

### ► Host immunity

*M. tuberculosis* infection in an infected host induces CMI. The CMI is manifested either as delayed tuberculin hypersensitivity or as resistance to infection. The course of infection is determined by the interaction of hypersensitivity or immunity.

**Tuberculin hypersensitivity reaction:** This was first described by Robert Koch in experimentally infected animals, such as guinea pigs. Demonstration of this tuberculin reactivity in guinea pigs is known as *Koch's phenomenon*. Koch phenomenon is demonstrated by subcutaneous injection of pure culture of virulent tubercle bacilli in a normal guinea pig. Initially, no immediate visible reaction is observed at the site of inoculation in the guinea pigs. But after 10–14 days, a hard nodule appears at the site of inoculation, which soon breaks down to form an ulcer that persists till the animal dies of progressive tuberculosis. The regional lymph nodes draining the region become enlarged and caseous.

In contrast, when a guinea pig already inoculated 4–6 weeks earlier by tubercle bacilli is injected with tubercle bacilli, an individual lesion develops at the site of second inoculation within 24–48 hours. The lesion undergoes necrosis in another day to produce a shallow ulcer that heals rapidly, involving the regional lymph nodes and other tissues.

### Key Points

The Koch's phenomenon is a combination of both hypersensitivity and immunity, which has three components:

- Local reaction (induration and necrosis),
- A focal response (congestion and even hemorrhage around tuberculous foci), and
- A systemic response (fever), which may even be fatal.

The DTH can be induced by live attenuated and killed bacilli, bacillary products, and tubercular protein. Usually live or killed bacilli or tubercular protein (tuberculin) are employed for demonstration of hypersensitivity reaction. This hypersensitivity reaction can be transferred passively by cells, but not by serum.

**Tuberculin test:** Tuberculin test is performed to demonstrate delayed type IV or cell-mediated hypersensitivity reaction to tubercle bacilli. Originally, the tuberculin test was performed by using a protein known as old tuberculin (OT) prepared by Robert Koch.

The OT is a protein component of tubercle bacilli prepared from a 6–8 week culture filtrate of *M. tuberculosis* cultured in 5% glycerol, which is concentrated 10-fold by evaporation on a steam bath. The OT is a crude protein, which consists of protein as a constituent but varies from batch to batch in its purity and potency. This has now been replaced by the use of PPD of tubercle bacilli.

**Humoral immunity:** Humoral immunity is characterized by the development of antibodies in serum, but they do not play any role in conferring immunity against the bacteria. Antibodies against polysaccharide, proteins, and phosphate antigens of tubercle bacilli have been demonstrated in serum of patients with tuberculosis. These serum antibodies, however, are not protective.

### Clinical Syndromes

The clinical manifestations of tuberculosis depend on the site of infection. However, primary infection is usually pulmonary. *M. tuberculosis* produces following clinical syndromes: (a) pulmonary tuberculosis and (b) extrapulmonary tuberculosis.

#### ► Pulmonary tuberculosis

Productive cough, fever, and weight loss are typical symptoms of pulmonary tuberculosis. Hemoptysis or chest pain, night sweats, fatigue, and anorexia are the other systemic manifestations. The sputum may be scanty or bloody and purulent and, as a result, is usually associated with cavitory lesions in the lung.

Pulmonary tuberculosis may manifest in various forms including progressive pulmonary disease, involvement of pleura, and reactivated pulmonary disease. Pulmonary complications include relapse, aspergillomas, bronchiectasis, broncholithiasis, and fibrothorax.

#### ► Extrapulmonary tuberculosis

Extrapulmonary tuberculosis usually occurs as a result of spread of the bacilli through blood circulation during the initial stage of multiplication at the site of primary infection, i.e., lung. Depending on the site of infection, extrapulmonary infections may be: (a) genitourinary tuberculosis, (b) tubercular meningitis, (c) gastrointestinal tuberculosis, (d) skeletal tuberculosis, (e) tubercular lymphadenitis, and (f) other conditions.

**Genitourinary tuberculosis:** Genitourinary tuberculosis is one of the most common extrapulmonary manifestations of tuberculosis. The typical symptoms include dysuria, increased frequency of urination, and flank pain. The condition in men may manifest as epididymitis or a growth in the scrotal area. In women, the condition may manifest as pelvic inflammatory disease. Genitourinary tuberculosis is responsible for approximately 10% of sterility in women.

**Tubercular meningitis:** This is one of the most severe complications of tuberculosis. The condition may persist as headache, which is either intermittent or persistent.

**Gastrointestinal tuberculosis:** The clinical manifestation of the condition depends on the site affected in the gastrointestinal tract. For example, infection of stomach or duodenum manifests as abdominal pain mimicking peptic ulcer disease, whereas infection of large intestine manifests as pain in abdomen, diarrhea, etc.

**Skeletal tuberculosis:** Spine is the most common site involved in skeletal tuberculosis resulting in Pott's disease.

**Tubercular lymphadenitis:** Tubercular lymphadenitis or scrofula most commonly involves the neck along the sternocleidomastoid muscle. The condition is usually unilateral, with little or no pain.

**Other conditions:** These include miliary tuberculosis, tuberculosis of the skin, and tuberculosis of the middle ear and ocular structures.

## Complications of Tuberculosis

Miliary disease, disseminated tuberculosis, and tubercular meningitis are the most serious complications of primary tuberculosis. Pleural effusion and pneumothorax are the noted pulmonary complications of tuberculosis. Intestinal perforation, obstruction and malabsorption are the complications of tuberculosis of small intestine. Hydronephrosis and autonephrectomy are the renal complications, whereas paraplegia is the complication of Pott's disease of the spine.

### ▶ Tuberculosis with HIV

HIV patients with tuberculosis are more likely to progress to disseminated disease. These patients usually do not have cavitary pulmonary disease or upper lobe infiltrates in the lung. Patients with tuberculosis should be tested for HIV and those with HIV need to be tested periodically for tuberculosis by tuberculin skin test and chest radiography. HIV patients with a positive tuberculin skin test (TST) usually develop active tuberculosis at a rate of 3–16% per year.

HIV reactivates latent tuberculosis infection, makes the disease more serious, and renders treatment ineffective. The patients with both HIV and tuberculosis on treatment with antiretroviral therapy develop various clinical manifestations, which include fever, lymphadenopathy, and noninvasive pulmonary infiltrates. This has been suggested due to a stronger immune response to *M. tuberculosis*.

## Epidemiology

Tuberculosis is the number one infectious killer disease worldwide.

### ▶ Geographical distribution

One-third of the world population is infected with *M. tuberculosis*. Nearly, two-thirds of all cases of tuberculosis occur in the developing countries including India, Pakistan, China, Bangladesh, Philippines, Indonesia, Thailand, and Congo. Nearly, 3 million people die of tuberculosis every year and nearly 2 billion people have latent tuberculosis.

Tuberculosis is a major health problem in India. More than 40% of the population is infected with *M. tuberculosis*, and nearly 15 million people suffer from tuberculosis of which 3 million people are highly infectious open cases of tuberculosis. Nearly half a million people die from the disease every year.

### ▶ Habitat

*M. tuberculosis* inhabits primarily the respiratory tract of the infected human host. The droplet nuclei consisting of *M. tuberculosis* have been found in the terminal air spaces of the lung.

### ▶ Reservoir, source, and transmission of infection

Human beings are the only source and reservoir for *M. tuberculosis* infection. The infectiousness of the source is of primary importance, which determines the possibility of transmission of the disease. This depends on bacillary load of lesions and also on the morphology of the lesion. Lesions with cavities have 100–10,000 bacilli; therefore, cases with cavitary lesions are potentially highly infectious. Cases treated with antitubercular therapy are less infectious than those who are not treated with any antitubercular drugs. The decrease in infectiousness is primarily due to reduction in the bacillary load in the lungs. Humans acquire *M. tuberculosis* infection most frequently by inhalation of infectious aerosolized droplets. These infective droplets are usually coughed or sneezed into environment by a patient suffering from pulmonary tuberculosis. The acts of coughing, sneezing, and speaking release a large number of droplets containing as many as 3000 infectious airborne droplet nuclei per cough. The droplet nucleus is small, measures 5  $\mu\text{m}$  or less, and may contain approximately 1–10 tubercle bacilli. Theoretically, although a single tubercle bacillus may cause disease, in practice 5–200 inhaled bacilli are essential for infection. These droplets by virtue of their small size remain suspended in the air for a very long period of time. The infection is acquired rarely by inoculation.

*M. bovis* infection is transmitted to humans by ingestion of raw milk of the cows infected with *M. bovis*. The infection among animals is spread by aerosolized bacilli in moist cough sprays. The infected animals usually excrete the bacilli in their milk. Person-to-person transmission of *M. bovis* usually does not occur.

**Risk factors for tuberculosis:** Primary infection of lung occurs as a result of inhalation of the infectious aerosols. The risk of infection depends on the exposure to ultraviolet rays and ventilation; therefore the risk of infection is high in small rooms and in rooms with poor ventilation. There are many risk factors for tuberculosis:

- HIV is one of the most important risk factor. Case rates for individuals who are infected with both HIV and *M. tuberculosis* exceed the infective risk of individuals with *M. tuberculosis* infection who are not infected with HIV.

- Other factors that increase the risk of tuberculosis are steroid therapy, cancer chemotherapy, malignancies, and undernutrition. The latter condition alters CMI and, therefore, is responsible for the increased frequency of tuberculosis in impoverished persons.
- Persons with certain human leukocytic antigen (HLA types) are at increased susceptibility to acquisition of tuberculosis. Hereditary factors, such as presence of a *Bcg* gene, also have a predisposition to tuberculosis.
- Nontubercular factors, such as pertussis, varicella, and measles, may reactivate dormant and quiescent *M. tuberculosis* infection.

**Infection in mammals:** *M. tuberculosis* primarily causes natural infections in humans. The bacteria may also cause natural infections in other primates, dogs, and other animals, which come in close contact with infected humans. In experimental infections, *M. tuberculosis* is highly infectious for guinea pigs and hamsters but is usually nonpathogenic for bovines, goats, cats, and rabbits. Mice are moderately susceptible. *M. bovis* is more pathogenic for animals. The bacilli produce tuberculosis in cattle as well as in humans and other primates. Experimentally it is highly pathogenic for guinea pigs, calves, and rats and nonpathogenic for fowl.

African strains or *M. africanum* are the strains of tubercle bacilli that are isolated mostly from Africa. Asian type strains are of low virulence for guinea pigs, susceptible to hydrogen peroxide, resistant to INH, and are usually isolated from South India. These Asian strains have also been isolated from other Asian countries and from Asians abroad. Differential features of various strains of *M. tuberculosis* are summarized in Table 41-2.

## Laboratory Diagnosis

The clinical diagnosis of tuberculosis is supported by laboratory diagnosis and other tests including radiographic evidence of pulmonary disease. Definitive diagnosis of tuberculosis is made by detection of *M. tuberculosis* from clinical specimens by microscopy or culture.

### ► Specimen

Collection of the specimen depends on the nature of the infection whether pulmonary or extrapulmonary. Sputum, lung tissue, gastric lavage, and bronchoalveolar lavage are the specimens collected for diagnosis of pulmonary tuberculosis. Cerebrospinal fluid (CSF), pleural fluid, peritoneal fluid, urine, lymph node tissue, bone marrow and blood are the other specimens frequently used in the diagnosis of extrapulmonary tuberculosis. In general, few tubercle bacilli are present in extrapulmonary specimens than in sputum.

1. Sputum is the specimen of choice for pulmonary tuberculosis. Sputum, not saliva, is collected in the morning into a clean wide-mouthed container, such as sputum cup. Collection of morning sputum specimen is ideal. If sputum is scanty, 24-hour specimen may be collected.

Sputum specimen collected on three consecutive days increases the chance of detection of tubercle bacilli.

2. Gastric aspirate may be used in place of sputum, especially in young children who cannot produce the sputum. In older children, bronchial secretions may be collected by stimulation of the cough by using an aerosol solution of propylene glycol in 10% sodium chloride. Bronchoalveolar lavage may also be used for the diagnosis of pulmonary tuberculosis.
3. Urine is the specimen of choice for diagnosis of genitourinary tuberculosis. This is collected either as three consecutive early morning samples or as a single sample of completely voided urine in 24 hours.

The urine specimens are collected in large, clean, sterile containers of 500 mL or more capacity and sent to the laboratory for processing. The urine specimens are centrifuged at 300 rpm for 30 minutes, and the sediments are used for culture on selective media for *M. tuberculosis*.

4. CSF is collected for diagnosis of tubercular meningitis. The CSF is centrifuged and the sediment after centrifugation is stained for smears and is inoculated on the media for culture. CSF on standing for a long time develops a spider web, the examination of which shows more bacilli.
5. Pleural fluid, peritoneal fluid, and other exudates are collected in containers with citrate to prevent coagulation. Bone marrow and liver tissue are usually collected from patients with miliary tuberculosis, and blood is collected from patients with HIV for isolation of bacteria by culture.

It is essential to collect all these specimens before starting antitubercular therapy. The specimens after collection should be transported as immediately as possible for staining and culture. In case of delay, the specimens are refrigerated at 4°C, but not more than overnight. Further delay in processing decreases the possibility of isolation of tubercle bacilli by culture.

### ► Microscopy

Sputum microscopy is the most dependable and conventional method for demonstration of AFB by ZN staining method. The sputum smears are made by using new slides every time. The slides should not be reused, because AFB may adhere to the surface of the slide and may not be removed from the slide during the process of cleaning.

The smears are made from thick purulent part of the sputum and then are air dried, fixed by heating, and finally stained by ZN technique. The stained smear is examined under oil immersion lens (100×). Acid-fast bacteria in a stained smear appear bright red against a blue background. At least 50,000 to 1 lakh bacilli should be present per milliliter of sputum in order to be examined, taking about 10 minutes before giving negative report. The presence of at least two or more typical bacilli in the smear is reported as positive for AFB (Fig. 41-2, Color Photo 41).

The smears are graded depending on the number of tubercle bacilli present in a stained smear on examination by oil immersion lens.

## Key Points

Smear grading is useful:

- in a quantitative assessment of the number of bacilli in the sputum (Table 41-3);
- to estimate the infectiousness of the patient;
- to monitor the effectiveness of antimycobacterial therapy; and
- to determine the discontinuation of respiratory isolation.

Microscopic demonstration of AFB in stained smears is the presumptive diagnosis of tuberculosis. This is because ZN staining of AFB smears cannot be used to differentiate *M. tuberculosis* from other acid-fast organisms, such as saprophytic mycobacteria or *Nocardia* species.

Saprophytic mycobacteria may present appearance similar to that of *M. tuberculosis*. But nevertheless saprophytic mycobacteria stain uniformly without any barred or beaded appearance and are usually only acid fast but not alcohol fast. Moreover, these saprophytic mycobacteria are usually not present in the sputum and other respiratory secretions but are found in urogenital specimens, gastric aspirates, and fecal specimens.

Auramine–rhodamine stains are the fluorescent stains that are used as variation of the traditional ZN stain for demonstration of AFB. In this method, the smears are stained with auramine–rhodamine or auramine–phenol fluorescent dyes and are examined by fluorescent microscope under ultraviolet illumination. These AFB appear as bright fluorescing rods against a dark background. The bacilli, because of their contrast, are visualized even under a high power objective in contrast to oil immersion objective in ZN stain, thus enabling rapid screening of the larger areas of the smear. These fluorescent-stained slides can be screened faster, because the AFB stand out against the nonfluorescent background. This is the major advantage of this staining method, hence is adopted in the laboratories where many smears are to be examined for AFB. However, it is always essential to confirm fluorochrome-positive smears by ZN staining.

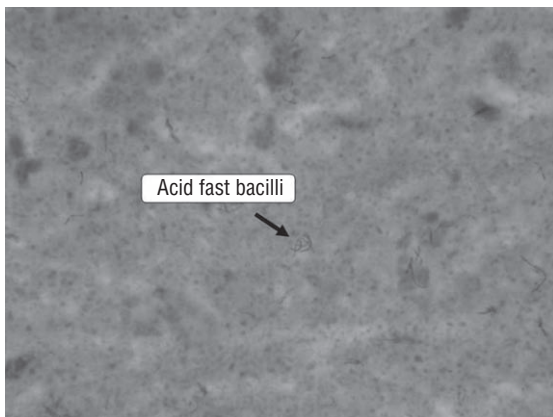

**FIG. 41-2.** ZN-stained smear of sputum specimen showing pink colored acid-fast bacilli ( $\times 1000$ ).

**TABLE 41-3**

**Grading of ZN-stained smears for AFB**

Examination by oil immersion field	Number of AFB	Interpretation
1 Field	10 or more	4+
1 Field	1–9	3+
10 Fields	1–9	2+
100 Fields	1–9	1+
300 Fields	1–2	Doubtful; repeat smear
300 Fields	0	AFB not seen
AFB, acid-fast bacilli.		

The sputum microscopy may be negative in the early stage of the disease or in children in whom bacilli in respiratory secretions are few.

### ► Concentration of specimens

Concentration methods have been described for concentration of mycobacteria in sputum and other specimens. By these methods, specimens are decontaminated and concentrated into a small volume without inactivation of the bacteria. The concentrated sediments are used for microscopy as well as for culture and animal inoculation. Several methods are now in use and include the following:

**Petroff's method:** It is a simple and widely used method. In this method, equal volume of sputum and 4% sodium hydroxide solution are mixed and incubated at 37°C with frequent shaking till it becomes clear, on an average for 20 minutes. It is then centrifuged at 3000 rpm for 30 minutes. The supernatant is discarded, and the sediment is neutralized by adding 8% hydrochloric acid. Phenol red is used as indicator.

**Other methods:** Other methods of concentration are available, which use dilute acids (6% sulfuric acid, 5% oxalic acid, or 3% hydrochloric acid) or mucolytic agents (*N*-acetyl-L-cysteine along with sodium hydroxide and pancreatin, desogen, zephiran, and cetrimide) for concentration of specimens.

### ► Culture

Culture is the definitive method to detect and identify *M. tuberculosis*. The culture is also more sensitive diagnostic method than microscopy of the smear. The culture may be positive with as few as 10–100 AFB per mm of a digested concentrated specimen. Another advantage of culture is that it helps in specific species identification and for determining drug susceptibility pattern of isolated strains.

LJ medium is an egg-based medium and the Middlebrook 7H10 and 7H11 media are the agar-based media, and these are conventionally used for culture. Since *M. tuberculosis* is a slow-growing organism, a period of 6–8 weeks is required for colonies to appear on these conventional culture media after incubation at 37°C. Growth of most strains of *M. tuberculosis* may appear during this period. However, cultures should not be discarded as negative until they have been observed for 12 weeks.



► Identification of bacteria

*M. tuberculosis* organisms are identified by their culture, growth, and biochemical tests. *M. tuberculosis* is weakly catalase positive, nitrate positive, reduces niacin, and grows slowly over a period of 4–6 weeks (Box 41-1). Differences between *M. tuberculosis* and *M. bovis* are summarized in Table 41-4.

**Niacin test:** This test is performed by adding 1 mL of sterile normal saline to colonies of *M. tuberculosis* in LJ medium. The medium is kept in a slanting position so that the colonies of mycobacterium are completely covered by normal saline. After sometime, 0.5 mL of the fluid is collected and is placed in a clean screw-capped test tube. To this fluid, 0.5 mL of alcoholic aniline as well as 0.5 mL of 10% cyanogen bromide is added. In a positive test, a yellow color develops in the solution within a few minutes. *M. tuberculosis* is niacin test negative. It does not produce any yellow color in the fluid.

**Arylsulfatase test:** This test is performed by culturing mycobacteria in a medium containing 0.001 M tripotassium phenolphthalein disulfate. *Mycobacterium* species producing the enzyme arylsulfatase split phenolphthalein free from

tripotassium phenolphthalein disulfate. The free phenolphthalein is detected by adding 2N sodium hydroxide to the culture. Development of pink color indicates positive reaction. *M. tuberculosis* is arylsulfatase negative, while some other *Mycobacterium* species are arylsulfatase positive.

**Neutral red test:** This test is carried out to detect ability of certain strains of mycobacteria to bind neutral red in an alkaline buffer solution. In this test, one to two colonies of mycobacteria grown on LJ medium are inoculated with 5 mL of ethyl alcohol collected in a screw-capped bottle. This bottle after inoculation is incubated at 37°C for 1 hour. Supernatant alcohol is then removed carefully and transferred to another bottle to which 5 mL of distilled water and 0.2 mL of 0.05% aqueous solution of neutral red are added. Then N/100 sodium hydroxide is added drop by drop till the color of the fluid becomes amber. The bottle is reincubated at 37°C for 1 hour in water bath with frequent shaking. The development of pink or red stained colonies in the amber-colored fluid suggests a positive test. *M. tuberculosis* and *M. bovis* are neutral red test positive.

**Catalase test:** This test is performed to detect the enzyme catalase produced by various *Mycobacterium* species. This test is performed by mixing equal volumes of 30% hydrogen peroxide and 10% of Tween 80 in a test tube. Then a few colonies of mycobacteria are picked up by a nichrome wire loop and are inoculated in the fluid. Formation of air bubbles in the fluid is observed within 1 minute. Demonstration of bubbles in the fluid indicates positive test (Fig. 41-3, Color Photo 42). If the bubbles appear in the fluid immediately, it is considered strongly positive, but if appear slowly, it is considered weakly positive. Absence of any bubble is considered as negative test. *M. tuberculosis* and *M. bovis* are weakly catalase positive. The bacilli lose their catalase activity when they develop resistance to INH.

**Amidase test:** This test detects the ability of certain mycobacteria to split amides, such as acetamide, nicotinamide, pyrazinamide, carbamide, and benzamide. This test is performed by

**Box 41-1** Identifying features of *Mycobacterium tuberculosis*

1. Straight or slightly curved acid-fast bacilli.
2. Slow growers, produce white to buff colored, rough, raised, irregular, and tough colonies on LJ medium after 4–6 weeks.
3. Luxuriant eugonic growth.
4. Weakly catalase positive.
5. Neutral red test positive.
6. Amidase positive.
7. Nitrate reduction test positive.
8. Pyrazinamidase test positive.
9. Niacin test negative.
10. Arylsulfatase negative.
11. Sensitive to 50 mg/mL pyrazinamide.

TABLE 41-4

Differential features of *Mycobacterium tuberculosis* and *Mycobacterium bovis*

Character	<i>Mycobacterium tuberculosis</i>	<i>Mycobacterium bovis</i>
Microscopy	Slender or slightly curved rods with barred or beaded appearance	Straight, stout, short, and uniformly stained rods
Oxygen requirement	Obligate aerobe	Microaerophilic on primary isolation but becomes aerobic on subculture
Days for appearance of colonies at 37°C	12–25 days (eugonic growth)	20–40 days (dysgonic growth)
Effect of glycerol (0.75%)	Enhances the growth	Inhibits the growth
Colony	White to buff colored, rough, and tough colonies	White, moist, smooth, flat, and friable colonies
Nitrate reduction	+	–
Niacin production	+	–
Tween 80 hydrolysis	Variable	–
Susceptibility to pyrazinamide (50 µg/mL)	+	–
Pathogenicity to guinea pigs	+	+
Pathogenicity to rabbits	–	+

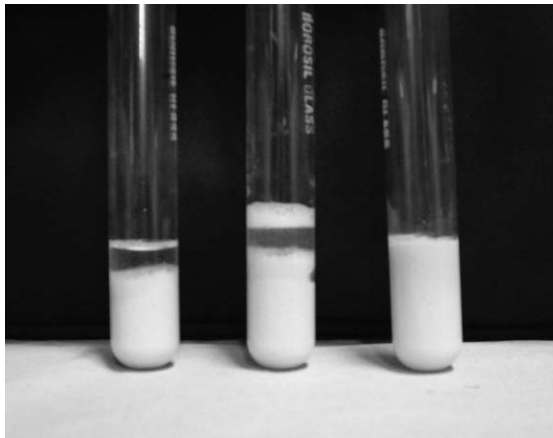

FIG. 41-3. Semiquantitative catalase test.

inoculating 0.00164 M solution of the amide with the mycobacterial culture at 37°C. Then 0.1 mL of manganese sulfate, 1 mL of phenol solution, and 0.5 mL of hypochlorite solution are added to the solution. The tubes are then kept in boiling water bath for 20 minutes. Positive test is indicated by the development of blue color in the fluid. *M. tuberculosis* is amidase positive, produces the enzyme nicotinamidase and pyrazinamidase.

**Nitrate reduction test:** This test detects the presence of enzyme nitrate reductase produced by *M. tuberculosis* and other *Mycobacterium* species. It is performed by adding colonies of the mycobacteria to buffered solution containing nitrate and incubating at 37°C for 2 hours. After incubation, sulfanilamide and *N*-naphthyl-ethylene diamine hydrochloride solution is added. Development of pink or red color within 30–60 seconds is suggestive of a positive test. *M. tuberculosis* and other mycobacterial species are nitrate reductase test positive, whereas *M. bovis* and *M. avium* are negative.

**Tween 80 hydrolysis:** This test is performed to demonstrate the enzyme lipase produced by certain mycobacterial species. It is carried out by adding a loopful of mycobacterium culture to a solution containing Tween 80, buffer, and neutral red. The inoculated medium is inactivated at 37°C, and the reaction is observed first at 3–6 hours, then at third day, and thereafter daily up to a period of 10 days. Development of pink color indicates positive Tween 80 hydrolysis test. *M. tuberculosis* shows a variable result. *M. kansasii* produces a positive test within 3–6 hours, while other mycobacteria species produce positive test within 3–10 days.

**NAP differentiation test:** This test is based on the principle that addition of *p*-nitro acetyl-amino-hydroxyl-propionophenone (NAP) inhibits the growth of *M. tuberculosis* as well as *M. bovis* and *M. africanum*. This substance does not inhibit growth of other *Mycobacterium* species.

**DNA probe:** Nucleic acid hybridization using DNA probes is increasingly used to identify the species. These commercially available probes help in the identification of *M. tuberculosis* complex much earlier. The DNA probes show a sensitivity and

specificity of 100%, when at least 100,000 tubercle bacilli are present. This test uses chemiluminescent ester-labeled single-stranded DNA probes. The chemiluminescence is determined by using luminometer. Positive DNA probe test indicates the mycobacteria to be *M. tuberculosis*, *M. bovis*, or *M. africanum*. The probe cannot differentiate between these species. Niacin production, nitrate reduction, and production of pyrazinamidases are useful tests to differentiate *M. tuberculosis* from *M. bovis* (Table 41-4).

**Pyrazinamide test:** *M. tuberculosis* is sensitive to 50 µg/mL pyrazinamide and is pyrazinamidase test positive. *M. bovis* is pyrazinamidase test negative.

**TCH susceptibility test:** *M. tuberculosis* is resistant to 10 µg/mL of TCH, while *M. bovis* is susceptible to TCH.

### ► Mycobacteria drug susceptibility testing

With the emergence of multidrug resistant (MDR) mycobacteria, determination of drug susceptibility testing is important for starting appropriate treatment. Drug susceptibility can be demonstrated by both (a) phenotypic susceptibility assays and (b) genotypic methods.

- **Phenotypic assay** methods include (i) resistance ratio method, (ii) absolute concentration method, (iii) proportion method, and (iv) radiometric methods.
- **Genotypic methods** include (i) DNA sequencing, (ii) solid phase hybridization, and (iii) polymerase chain reaction (PCR)—single-stranded combination polymorphism analysis.

### ► Serodiagnosis

*M. tuberculosis* infection is associated with elevated levels of antibodies in the serum. Various mycobacterial antigens have been used in these serological tests, which include BCG, 5 and 6 kDa proteins of *M. tuberculosis*, 32 and 64 kDa protein of *M. bovis*, etc. Detection of antibodies by serological test, such as enzyme linked immunosorbent assay (ELISA), is of limited value in the diagnosis of pulmonary tuberculosis. Latex agglutination test using latex particles coated with rabbit antibody against *M. tuberculosis* has been used for demonstration of antigen in the CSF for diagnosis of tuberculosis meningitis.

### ► Animal inoculation

Guinea pig inoculation is carried out by intramuscular inoculation of concentrated clinical specimens into thighs of two 12 weeks' old healthy guinea pigs. Development of infection is suggested by a progressive loss of weight and development of a positive tuberculin skin reaction. One of the two animals is sacrificed after 4 weeks.

In a positive infection, the autopsy of the animal shows a caseous lesion at the site of inoculation. At times, the local cutaneous lesion may be associated with formation of pus at

## Molecular Diagnosis

PCR and other nucleic acid amplification methods are useful for direct detection of *M. tuberculosis* in clinical specimens, such as CSF. The AMPLICOR *M. tuberculosis* direct test is an example of nucleic acid amplification tests available in developed countries, such as the United States. The AMPLICOR test targets the insertion sequence IS6110 in the DNA of the tubercle bacilli. The sensitivity of the test varies from 40% to 60% and specificity is 95% in smear-positive cases of tuberculosis. The test is also rapid. Disadvantages of the test includes contamination of clinical specimen by products of previous amplification and presence of inhibitors that may give rise to false-negative or false-positive reactions.

the site of the cutaneous lesion and enlarged caseous lymph nodes draining the region. Spleen, liver, peritoneum, and lungs show development of tubercles varying 1–2 mm in diameter. The stained smear of the exudates shows the presence of AFB by microscope. *M. tuberculosis* is highly pathogenic for guinea pigs, while catalase-negative INH-resistant strains and most strains isolated from south India are low pathogenic for guinea pigs. *M. tuberculosis* is nonpathogenic for rabbits. *M. bovis* is pathogenic for both rabbits and guinea pigs.

Inoculation in guinea pigs was earlier widely used for diagnosis of tuberculosis. But guinea pig inoculation is now regarded as obsolete, because it is cumbersome, costly, and less sensitive than culture. Guinea pig inoculation is, however, superior to culture for isolation of *M. bovis* from clinical samples.

### ► Tuberculin skin test

Tuberculin skin test (TST) is a widely used test for diagnosis of tuberculosis:

- It is used for evaluation of cases that have tuberculosis and for diagnosis of cases suspected to be infected with *M. tuberculosis*.
- It is used to diagnose active tuberculosis infection in infants and young children.
- It is also used to select population susceptible for BCG (bacille Calmette–Guerin) vaccination.
- It is a valuable test to measure prevalence of tuberculosis infection in a community.

TST can be performed by the following methods:

**Mantoux test:** Mantoux test is the recommended method of skin test. The test is performed by intradermal injection of 0.1 mL or 5 tuberculin units (TU) PPD into the volar aspect of the forearm using a 27-G needle. It is essential that PPD is injected between the layers of the skin, but not subcutaneously. Development of an induration of 10 mm or more at the site of injection after 48–72 hours is considered a positive test. Induration less than 5 mm is negative, while between 6 and 9 mm is considered equivocal. Erythema is not considered in reading of the test.

If the test is negative with the PPD of 5 TU, then the test may be repeated using PPD of 10 or 100 TU. Purified protein derivative of 1 TU is used when the recipient is considered to be extremely hypersensitive to the antigen.

**Multiple puncture tests:** These include the Heaf test and time test. Heaf test is performed by using the hit gun and by using disposable prongs carrying dried PPD. These tests may be satisfactory for screening and surveys but are not useful as diagnostic test because they lack sensitivity and specificity.

A positive skin test indicates hypersensitivity of the individual to tubercle protein. This suggests infection with *M. tuberculosis* or immunization by BCG vaccination in recent or past with or without clinical disease. The TST becomes positive 4–6 weeks after infection or immunization. The tubercle test positivity gradually disappears within 4–5 years in absence of reexposure to tubercle bacilli. In endemic areas, this positivity is maintained due to repeated exposure to tubercle bacilli. A negative tubercle test indicates that the person has never come in contact with tubercle bacilli.

The TST may show false-positive and false-negative reactions:

1. **False-positive reaction** occurs in patients with infection by environmental nontuberculous mycobacteria.
2. **False-negative reactions** may occur in patients with (a) vaccination, (b) immunosuppressive therapy, (c) impaired CMI, (d) lymphoreticular malignancies, (e) immunodeficiency, (f) malnutrition, and (g) miliary tuberculosis. Improper administration, such as subcutaneous injection of PPD or injection of too little volume of antigen, contamination of PPD, or improper storage are the other factors that may give rise to false-negative reactions.

### ► Rapid and automated methods

The conventional methods are very slow and time consuming and require 6–8 weeks for isolation of *M. tuberculosis*. Hence, recently more rapid and automated methods are being increasingly used for diagnosis of tuberculosis. These recent methods include automated radiometric culture methods (e.g., BACTEC), SEPTICHEK, mycobacterial growth indicator tubes (MGITs), etc.

- **Automated radiometric culture methods**, such as BACTEC employ a liquid Middlebrook 7H12 medium containing radiometric palmitic acid labeled with radioactive carbon-14 ( $^{14}\text{C}$ ). The medium also contains several antimicrobial agents to prevent the growth of other nonmycobacterial microbes. The result of the test is noted by demonstration of radiolabeled  $^{14}\text{CO}_2$  produced during the growth of mycobacteria. Growth of mycobacteria is usually detected within 9–16 days.
- **SEPTICHEK** is another rapid method for isolation of mycobacteria. This is a nonradiometric method, which is based on a biphasic broth-based system that decreases the mean recovery time versus conventional methods.

- A new method employs *MGITs*, which show microbial growth and provide a quantitative index of *M. tuberculosis* growth. Round-bottom tubes with oxygen-sensitive sensors at the bottom are used in the test.

## Treatment

Chemotherapy by antitubercular drugs has revolutionized the treatment of tuberculosis. Antituberculous therapy destroys the tubercle bacilli, thereby preventing further complications of early primary disease and progression of disease. Therapy with antituberculous drugs causes disappearance of caseous or granulomatous lesions. Antituberculous drugs are classified as first-line and second-line drugs as follows:

### ► First-line antitubercular drugs

First-line antitubercular drugs include rifampicin, INH, ethambutol, streptomycin, and pyrazinamide. All first-line drugs with the exception of ethambutol are bactericidal. These drugs have less toxicity and show greater efficacy than second-line drugs. Both INH and rifampicin are effective against tubercle bacilli in necrotic foci and intracellular mycobacteria. In contrast, streptomycin, aminoglycosides, and capreomycin show poor intracellular penetration.

Combination of four drugs (INH, rifampicin, pyrazinamide, and ethambutol) is given for a period of 6–7 months for treatment of smear-positive cases of tuberculosis. These are given three times a week for first 2 months, followed by only two drugs (INH, rifampicin) three times a week.

Emergence of natural drug resistance in *M. tuberculosis* is a major problem in chemotherapy of tuberculosis. This occurs by mutation with a frequency of appropriately  $10^6$  cell divisions.

**Multiple drug resistance:** If the cases of tuberculosis are treated with a single antitubercular drug, the subpopulation of tubercle bacilli susceptible to that drug are killed, whereas populations not susceptible to the drug continue to multiply. Therefore, the use of multiple antitubercular agents in the treatment of tuberculosis is useful. The emergence of multidrug-resistant tuberculosis (MDR-TB) is a very serious problem and is defined as resistance to rifampicin and INH with or without resistance to one or more other drugs. This is because rifampicin and INH form the mainstay of short-term chemotherapy, and *M. tuberculosis* strains resistant to both these drugs are unlikely to respond to treatment. Multiple drug resistance (MDR) is of two types—primary and secondary.

**Primary MDR** is defined as development of resistance to antitubercular treatment in an individual who has no history of antitubercular treatment. It usually occurs:

- In patients residing in areas with a high prevalence of drug-resistant *M. tuberculosis*,
- In those exposed to drug-resistant contagious tuberculosis, and
- In those with HIV infections and in the individuals using intravenous drugs.

**Secondary MDR** is defined as emergence of antitubercular resistance during the course of infection and antitubercular treatment. It develops usually:

- In patients treated with inappropriate drug regimen and
- In those not taking antituberculous drugs regularly.

The initial antitubercular regimen for patients with MDR includes four drugs. These contain at least four bactericidal drugs, such as INH, rifampicin, pyrazinamide, and either streptomycin or another aminoglycoside or a high dose of ethambutol.

### ► Second-line antitubercular drugs

Second-line antitubercular drugs are used for the cases of tuberculosis where first-line drugs become ineffective. These include a large number of old and new drugs, such as ciprofloxacin, cycloserine, ethionamide, kanamycin, ofloxacin, levofloxacin, capreomycin, and others. Directly observed therapy (DOT) is a method being recently followed for treatment of cases of tuberculosis. The DOT is extremely useful to prevent the emergence of drug resistance by ensuring patient compliance.

## Prevention and Control

These include chemoprophylaxis, vaccination, and general health measures.

### ► Chemoprophylaxis

Chemoprophylaxis or preventive chemotherapy is carried out by use of antitubercular drugs, such as INH. INH is usually used for treatment of:

- Persons with latent tuberculosis,
- Patients with HIV infection,
- Recent contact of patients with contagious tuberculosis in past 3 months, even if TST result is negative,
- Unvaccinated children, and
- Elderly person with radiological evidence of quiescent disease.

These cases are treated by INH, given in a dose of 5 mg/kg daily for 6–12 months. Results of the study have shown that chemoprophylaxis by INH has considerably reduced the risk of acquiring the disease nearly by 90%.

### ► Vaccination

Vaccination against tuberculosis is carried out by administration of the vaccine. BCG is a live attenuated vaccine prepared from attenuated strain of *M. bovis*. This attenuated strain was originally prepared by Calmette and Guerin (1921). They subcultured the bacterium every 3 weeks for 230 subcultures on potato soaked in sterile bile containing 5% glycerol during a period of 13 years. The BCG vaccine is available in liquid as well as freeze-dried (lyophilized) form. The lyophilized form is commonly used,

which is reconstituted with sterile physiological saline to make a final concentration of 0.1 mL before administration. The reconstituted vaccine has a shelf life of 3–6 hours. The vaccine is given by the administration of 0.1 mL of reconstituted vaccine intradermally.

In a positive test, small nodule develops at the site of inoculation 2–3 weeks after injection. It increases slowly in size and by about 5 weeks, it attains a diameter of 4–8 mm. It then subsides or breaks into a shallow ulcer, which heals by scarring.

Following BCG vaccination, a tuberculin-negative individual is converted into a positive reactor. The immunity following BCG vaccination is similar and may last for 10–15 years.

Although BCG vaccination has been used since 1921 and approximately 3 billion doses of vaccine have been given, the efficacy of the vaccine still continues to be controversial. Several field trials have been performed to assess the efficiency of the vaccine. The results have varied widely from 80% protection to a total absence of protection. However, two meta-analyses of the vaccine trials including the trials conducted in India have shown that BCG vaccine is effective against miliary and meningeal tuberculosis.

## Vaccines

- BCG is used widely for prevention of tubercular meningitis and disseminated tuberculosis, two serious and life-threatening diseases in children.
- BCG vaccine does not prevent infection with *M. tuberculosis*.
- Controversy exists about the efficacy of BCG vaccine against pulmonary tuberculosis.
- BCG vaccine is contraindicated in immunosuppressed patients with (a) HIV infection, (b) primary or secondary immunodeficiency, and (c) in patients receiving steroids. The complications of BCG vaccine include formation of subcutaneous abscess and development of lymphadenopathy at the site of inoculation. Disseminated tuberculosis and osteitis of epiphysis of the long bones are the rare complications. The complications may require treatment with antitubercular drugs except pyrazinamide.
- The vaccine is now being used in more than 100 countries and is given to infants usually at birth. The WHO recommends the use of vaccine in children who have asymptomatic HIV infection in the areas where the risk of tuberculosis is high.

### ► General health measures

General health measures include adequate nutrition, good housing, and health education.

## CASE STUDY

A 30-year-old male laborer working in a stone-crushing unit attended Medicine OPD with history of fever and cough with purulent sputum for the past 3 months, associated with loss of weight, and loss of appetite, and cough with expectoration. Gram stain of sputum sample showed normal commensal flora. WBC count and ESR (erythrocyte sedimentation rate) were raised. Chest X-ray showed presence of cavity in left apical lobe of the lung. ZN stain smear of the sputum sample showed presence of AFB. Serum was positive for HIV antibodies by ELISA.

- Diagnose the condition.
- Describe the recent methods for diagnosis of the condition.
- Discuss the antibiotic regimen for treatment of the condition.
- Describe the vaccines available against the disease.

# Nontuberculous Mycobacteria

## Introduction

Nontuberculous mycobacteria (NTM) are the mycobacteria other than the tubercle and lepra bacilli. These are also known as mycobacteria other than tubercle bacilli (MOTT). These bacteria, which normally occur as saprophytes of soil and water, may occasionally cause opportunistic infection in humans, which resemble tuberculosis. These bacteria, therefore, were also earlier known as atypical, environmental, or opportunistic mycobacteria. The bacteria causing opportunistic infections are summarized in Table 42-1. NTM or atypical mycobacteria show the following features:

1. Some of them are rapid growers. They produce colonies within 1–2 weeks of incubation in Lowenstein-Jensen (LJ) medium.
2. They can grow at 25°C, 37°C, and even at 44°C.
3. Some of them may produce bright yellow or orange pigments during their growth on the LJ medium.
4. They are acid fast as well as alcohol fast. They may differ from or may resemble the tubercle bacilli.
5. They are arylsulfatase test positive, but are niacin and neutral red reactions negative.
6. They are usually resistant to antitubercular drugs, such as streptomycin, isoniazid (INH), and *p*-aminosalicylic acid.
7. They are nonpathogenic for guinea pigs, but pathogenic for mouse.

MOTT are classified as rapid growers and slow growers:

- *Mycobacterium fortuitum*, *Mycobacterium chelonae*, and *Mycobacterium abscessus* are the examples of more rapidly growing *Mycobacterium* species, which require incubation for 3 days or more for development of the colonies.
- *Mycobacterium avium-intracellulare* complex and *Mycobacterium kansasii* are the slow-growing *Mycobacterium* species and require 3–8 weeks of incubation for their growth.

Most of the human infections are caused by *Mycobacterium tuberculosis* and *Mycobacterium leprae*. *M. avium* complex, *M. kansasii*, *M. abscessus*, *M. chelonae*, and *M. fortuitum* are the examples of MOTT associated with frequent human infections.

## Classification

Saprophytic bacteria or MOTT were classified by Runyon into four groups on the basis of their rate of growth and their ability to produce pigments in the presence or absence of light:

- **Runyon's group I:** Pigment-producing mycobacteria are classified into Runyon's group I (photochromogenic mycobacteria), which produce pigment on exposure to light.
- **Runyon's group II:** Runyon's group II (scotochromogenic mycobacteria), which produce pigments in the dark and in the light.
- **Runyon's group III:** Slow-growing nonpigmented mycobacteria are classified as Runyon's group III.
- **Runyon's group IV:** More rapidly growing mycobacteria are classified as Runyon's group IV (rapid growers).

This system of classification is known as Runyon's classification.

## Photochromogens

These strains do not produce any pigments in the colonies that are incubated in dark, but form pigments when the young culture is exposed to light for 1 hour in the presence of air and is reincubated for 24–48 hours. These bacteria produce yellow-orange pigments during such conditions. These mycobacteria are slow-growing ones, but grow faster (after 7 days) than the tubercle bacilli. The most common species are *M. kansasii*,

TABLE 42-1

Human infections caused by atypical *Mycobacterium* species

Bacteria	Diseases
<i>Mycobacterium kansasii</i>	Pulmonary disease
<i>Mycobacterium marinum</i>	Swimming pool granuloma
<i>Mycobacterium simiae</i>	Pulmonary disease (rare)
<i>Mycobacterium scrofulaceum</i>	Lymphadenopathy
<i>Mycobacterium gordonae</i>	Pulmonary disease (rare)
<i>Mycobacterium szulgai</i>	Pulmonary disease and bursitis (occasional)
<i>Mycobacterium xenopi</i>	Chronic pulmonary disease
<i>Mycobacterium avium</i> complex	Pulmonary disease, lymphadenopathy, and disseminated disease
<i>Mycobacterium ulcerans</i>	Buruli ulcer
<i>Mycobacterium fortuitum</i>	Post-trauma chronic abscesses
<i>Mycobacterium chelonae</i>	Post-trauma chronic abscesses
<i>Mycobacterium abscessus</i>	Abscesses
<i>Mycobacterium genevensis</i>	Disseminated diseases (AIDS-related)

*Mycobacterium marinum*, and *Mycobacterium simiae*. Some of these mycobacteria produce disease similar to pulmonary tuberculosis. Most of these mycobacteria have been isolated from water and soil in the environment.

*M. kansasii* reduces nitrates to nitrites (Color Photo 43) and shows a positive Tween 80 hydrolysis (Color Photo 44) test within 3–6 hours, while other mycobacteria species produce positive test within 3–10 days. *M. kansasii* causes a disease identical to pulmonary tuberculosis, which is associated with formation of cavity and scarring, usually in the upper lobe of the lungs. This species is the second most common NTM, next to *Mycobacterium avium* complex (MAC), as causative agent of lung diseases. These strains have been frequently isolated from tap water, and infected tap water is believed to be the major source of infection. *M. kansasii* grows rapidly on LJ medium, producing visible colonies within 2 weeks. It is sensitive to rifampicin and other antitubercular drugs.

*M. marinum* closely resembles *M. kansasii* but is differentiated from it by its (a) poor growth at 37°C, (b) failure to reduce nitrate to nitrite, and (c) failure to produce the enzyme catalase. *M. marinum*—originally isolated from fish—is the causative agent of swimming pool or fish tank granuloma. This condition is associated with development of superficial granulomatous lesions in the skin.

*M. simiae* associated with pulmonary disease in humans was originally isolated from monkeys. This species grows well at 37°C and is niacin positive, like *M. tuberculosis*.

## Scotochromogens

These mycobacteria are characterized by their ability to produce yellow, orange, or red pigmented colonies on the LJ medium even when incubated in dark (Fig. 42-1, Color Photo 45). These species are widely distributed in the environment. *Mycobacterium scrofulaceum*, *Mycobacterium gordonae*, and *Mycobacterium szulgai* are the important species.



**FIG. 42-1.** LJ media for growth of atypical *Mycobacterium* species: one medium showing yellow colonies of atypical mycobacteria, while the other medium showing no growth.

*M. scrofulaceum* causes infection localized to lymphatic tissues and is responsible for causing scrofula or cervical adenitis in children. Morphologically, on staining, the bacillus shows short or long filaments. It is sensitive to cycloserine, but resistant to INH.

*M. gordonae* rarely causes pulmonary disease. It is often found as a contaminant in tap water, hence called tap water scotochromogen. This is also found as a contaminant in clinical specimens. *M. gordonae* does not hydrolyze urea, nicotinamide, and pyrazinamide; in this respect, it differs from *M. scrofulaceum*.

*M. szulgai* occasionally may cause pulmonary disease and bursitis. It is a scotochromogen when grown at 37°C and photochromogen when grown at 27°C.

## Nonphotochromogens

Nonphotochromogens are the mycobacteria that do not produce pigment in dark or on exposure to light. These include *M. avium* complex (MAC), *Mycobacterium xenopi*, and *Mycobacterium ulcerans*. Group III nonphotochromogens also includes *Mycobacterium terrae*, *Mycobacterium triviale*, and *Mycobacterium nonchromogenicum*, which rarely cause infections in humans.

***M. avium* complex:** MAC consists of *M. avium* and *Mycobacterium intracellulare*. They are found commonly in the environment such as in soil and in water (brackish, ocean, and drinking water). MAC organisms are strongly acid-fast mycobacteria with a cell wall rich in lipids. They are weakly positive aerobic bacteria. This complex possesses 28 agglutination types. Types 1, 2, and 3 are considered as *M. avium* and other types as *M. intracellulare*. Ability to grow inside the cells is the main virulence determinant of the bacteria. In infected humans, development of the disease depends primarily on response of host to infection. MAC produces a disease similar to pulmonary tuberculosis in patients with compromised pulmonary function, such as patients with chronic bronchitis or obstructive pulmonary disease, i.e., previous damage to lungs as a result of infection or other disease.

In patients with human immunodeficiency virus (HIV) infection, MAC produces a typically disseminated disease affecting virtually every organ in infected humans. Intensity of infections caused by MAC in these patients is very high. In some patients, tissues are overloaded with mycobacteria, and blood contains nearly 100–1000 mycobacteria/mL of blood. The disseminated infection is commonly seen in persons at the terminal stage of the immunological disorder, with their CD4 count falling below 10 cells/cu mm.

Patients with acquired immunodeficiency syndrome (AIDS) acquire MAC infection following inhalation of infectious aerosols. The infection is also acquired by ingestion of the water or food contaminated with mycobacteria. Person-to-person transmission does not occur.

Diagnosis of infection is made by microscopy of clinical specimens and culture on LJ medium. Treatment with

clarithromycin or azithromycin combined with ethambutol and rifabutin for a long period is effective for the treatment of infection. Chemoprophylaxis with clarithromycin or azithromycin in AIDS patients with low CD4 cell count has reduced the incidence of MAC drastically in these patients.

*M. xenopi* was originally isolated from a cutaneous lesion of a South African toad (*Xenopus laevis*). The organism is a thermophilic mycobacterium, which may occasionally cause chronic pulmonary lesions in humans. Most of these infections have been documented from London. The bacteria have been isolated from mostly hot water taps and also from main water supplies in hospitals.

*M. ulcerans* is a skin pathogen, which was originally isolated from human ulcerative skin lesions in Australia (1958). Subsequently, the species causing similar cutaneous lesions have been documented from Uganda (Buruli ulcer), Nigeria, Congo, Malaysia, New Guinea, and Mexico. *M. ulcerans* grows slowly on LJ medium in 4–8 weeks when incubated at 31–34°C. However, this species fails to grow when incubated at 37°C in primary culture.

### Key Points

*M. ulcerans* is the only known mycobacterial species to produce exotoxins. This toxin is a phospholipoprotein-lipopolysaccharide complex with a high molecular weight. The toxin produces inflammation and necrosis when inoculated intradermally into the skin of guinea pigs and lesions similar to those seen in humans are formed. It is therefore believed that the toxin plays an important role in the pathogenesis of ulcer—the main pathology of the disease seen in humans.

Ulcers of the skin are typically seen on the legs or on the arms. After an incubation period of few weeks, initially the infection begins by minor injuries on the skin through which mycobacteria gain access. The infection begins with the appearance of an indurated nodule at the site of inoculation, which breaks down forming an indolent ulcer. Diagnosis of the condition is made by microscopy of the smears, collected from the edge of the ulcer. Large number of acid-fast and alcohol-fast bacilli are

seen in the stained smear by microscopy. Finally, the ulcer heals with formation of scars.

### Rapid Growers

Group IV, or rapid growers, is a heterogenous group of mycobacteria that produce visible growth on LJ medium rapidly within 1 week of incubation at 37°C or 25°C. This group may also include photochromogens, scotochromogens, or nonphotochromogens species.

Some of the rapid growers are chromogenic (*Mycobacterium smegmatis*, *Mycobacterium phlei*) and are saprophytes. These rapid-growing mycobacteria include five species which are recognized as important opportunistic pathogens of humans. These *Mycobacterium* species are *M. fortuitum*, *M. chelonae*, *M. abscessus*, *M. smegmatis*, and *M. phlei*. All these rapid growers:

- stain irregularly with acid-fast stains;
- show relatively low virulence; and
- are relatively more susceptible to treatment with conventional antibacterial antibiotics than to antimycobacterial agents.

These bacteria are usually associated with diseases of deep subcutaneous tissues following trauma or iatrogenic infections. These species have been isolated from contaminated wound dressing, infections associated with intravenous catheter, or infections associated with prosthetic devices, such as heart-lung machine. Such infections are now being increasingly recognized from hospitalized patients due to increase in the use of such medical devices.

*M. fortuitum* and *M. chelonae* are nonchromogens; they do not produce any pigments. Both the species cause chronic abscesses in humans following infections of vaccines and other preparations contaminated by these mycobacteria. The infection also occurs following some injury. These bacilli are usually found in the soil. *M. fortuitum* causes pulmonary disease similar to pulmonary tuberculosis. Both *M. chelonae* and *M. fortuitum* grow well at 35°C and form white- to cream-colored colonies and reveal coccoid to filamentous morphology on staining.

TABLE 42-2

Differential properties of important atypical *Mycobacterium* species

Organism	Growth				Pigment		Urease	Niacin	Nitrate reduction
	7 days	25°C	37°C	45°C	Dark	Light			
<i>Mycobacterium kansasii</i>	–	+	+	–	–	+	+	–	+
<i>Mycobacterium marinum</i>	–	+	±	–	–	+	+	–	–
<i>Mycobacterium scrofulaceum</i>	–	+	+	–	+	+	+	–	–
<i>Mycobacterium avium intracellulare</i> complex	–	±	+	±	–	–	–	–	–
<i>Mycobacterium fortuitum</i>	+	+	+	–	–	–	+	–	+
<i>Mycobacterium chelonae</i>	+	+	+	–	–	–	+	–	–



*M. phlei* is mostly nonpathogenic. It produces buff-colored colonies, which on further incubation become yellow to orange. *M. phlei* differs from *M. smegmatis* by its ability to grow at 52°C and survive heating at 60°C for 4 hours.

*M. smegmatis* is normally found in smegma, a whitish secretion around the orifice of urethra. These bacilli are slender,

curved, and rigid rods. These bacilli are both acid and alcohol fast, but some bacilli may only be acid fast but not alcohol fast. *M. smegmatis* is a rare human pathogen associated with occasional cases of lung, skin, and bone infections.

Differential properties of important atypical *Mycobacterium* species are summarized in Table 42-2.



## CASE STUDY

A young man was admitted in the Medicine ward with history of severe cough and fever for 15 days. Detailed history revealed that he was a lorry driver and was exposed to multiple sexual partners. His serum was positive for HIV antibodies. ZN-stained smear from early morning sputum sample was positive for acid-fast bacilli. Chest X-ray revealed diffuse haziness. Sputum culture on LJ medium showed growth within 3 days. The colonies were nonpigmented in presence or absence of light.

- What is the most probable diagnosis?
- What are the predisposing factors in causation of diseases due to atypical mycobacteria?
- How will you diagnose this condition in the laboratory?
- What are the antibiotics used for treatment of the condition?

# *Mycobacterium leprae* and *Mycobacterium* *lepraemurium*

# 43

## Introduction

*Mycobacterium leprae* is the causative agent of leprosy, a chronic granulomatous disease primarily affecting the skin and peripheral nervous system. *M. leprae* was the first bacterial pathogen to be associated with a specific human disease and the only mycobacterium known to cause infection of the nervous tissue. The Koch's postulates have never been fulfilled for *M. leprae*, because so far it has not been cultivated *in vitro*.

## *Mycobacterium leprae*

*M. leprae* was discovered in 1873 by Arinuer Hansen in Italy. Leprosy was not initially thought to be an infectious disease, despite discovery of *M. leprae*. Tremendous advancement has been made on the knowledge of pathogenesis, cause, treatment, and prevention of leprosy during the last 25 years. Nevertheless, the lesions were responsible for the social stigma attached to the disease.

## Properties of the Bacteria

### ► Morphology

*M. leprae* shows the following morphological features:

- *M. leprae* is less acid fast than *Mycobacterium tuberculosis*. Hence 5% sulphuric acid, instead of 20%, is used for decolorization after staining with carbol fuchsin.
- It is Gram positive and stains more readily than *M. tuberculosis*.
- It is a straight or slightly curved rod with parallel sides and rounded ends. It measures 1–8  $\mu\text{m}$  in length and 0.2–0.5  $\mu\text{m}$  in diameter, showing considerable morphological variations. The bacteria exhibit cubical, lateral, or even branching forms.
- *M. leprae* is an obligate intracellular bacterium that multiplies preferentially in tissues at cooler temperature.
- *M. leprae* are nonmotile and nonsporing.

The bacilli are seen singly and in groups intracellularly as well as extracellularly lying free outside the cell. The bacilli inside the cell are usually present in parallel bundles of 50 or more. Acid-fast bacteria are bound together by a lipid-like substance known as glia. These masses of bacteria are known as globi. The parallel rows of bacilli in the globi present a “cigar bundle” appearance. These are present inside the large undifferentiated

histiocytes, which have a foamy appearance. These are known as Virchow's lepra cells or foamy cells.

### ► Culture

So far, *M. leprae* has not been cultivated *in vitro* either in bacteriological media or in tissue culture. The ICRC (Indian Cancer Research Center) bacillus is an example of an acid-fast bacillus and was first isolated from a leprosy patient employing human fetal spinal ganglion cell culture. This bacillus was reported in 1962 from the Indian Cancer Research Center, Mumbai, and has been adapted for growth on Lowenstein-Jensen (LJ) medium. However, its relation to *M. leprae* is uncertain, and many studies have suggested that ICRC bacillus is not *M. leprae* but may be a variant of *Mycobacterium*, belonging to *Mycobacterium avium* intracellulare group.

**Experimental animal models:** Many attempts have been made to develop a suitable experimental animal model for *M. leprae*. These include the following:

**Footpads of mice:** Shepard, in 1960, was the first to culture lepra bacilli in the footpads of mice kept at a low temperature of 20°C. The mouse footpad inoculation method is now being used as a standard procedure for experimental works by using *M. leprae*. Intradermal inoculation of lepra bacilli into the footpads of mice results in development of granuloma at the site of inoculation in 1–6 months. The mouse footpad model has been used to test (a) the maximum required concentration of antileprosy drugs and (b) sensitivity of the bacilli to new antileprosy drugs.

**Thymectomized mouse:** A thymectomized mouse is an experimental animal model, in which cell-mediated immunity (CMI) is suppressed by thymectomy on administration of antilymphocytic serum. In such mice, inoculation of *M. leprae* produces a generalized infection similar to that of lepromatous leprosy. Thymectomized irradiated mice model has also been used to detect small numbers of live lepra bacilli and is also used to detect persistent disease following treatment by chemotherapy.

**Nine-banded armadillo:** The armadillo (*Dasypus novemcinctus*) is another animal highly susceptible to infection with *M. leprae*. In armadillos, *M. leprae* cause a generalized infection with extensive multiplication of the bacteria. *M. leprae* in these animals produces a lesion typical of lepromatous leprosy and survives for about 400 days in infected armadillos. This animal is now being used as the most important source of lepra bacilli for genetic studies including development of vaccine. Natural

infections by *Mycobacterium* organisms resembling *M. leprae* have also been observed in some wild armadillos held in captivity in Texas and Mexico.

**Other animals:** Other animals that have been used for experimental infection by *M. leprae* include slender loris, Indian pangolin, and Korean chipmunks. *M. leprae* shows the longest generation time among all bacteria requiring 12–13 days to double in experimental infected mice as compared to about 14 hours in case of *M. tuberculosis* and about 20 minutes in case of coliform bacilli.

► **Other properties**

**Susceptibility to physical and chemical agents:** *M. leprae* remains viable in warm humid environment for 9–16 days and in moist soil for 46 days. They also remain viable on exposure to ultraviolet light for 30 minutes and to direct sunlight for 2 hours.

**Cell Wall Components and Antigenic Structure**

The genomic sequence of *M. leprae* has been mapped and completed recently. The genes responsible for its major protein have been cloned and sequenced. One important finding is that *M. leprae* retains genes for formation of mycobacterial cell wall. The cell wall components of *M. leprae* stimulate the production of IgM antibodies and cell-mediated immune response, and also moderate the bactericidal activity of macrophages. The cell wall of *M. leprae* like that of other mycobacteria consists of four layers:

- Peptidoglycan is the innermost layer, which gives the bacteria rigidity and shape.
- Lipoarabinomannose-B (LAM-B) is a layer next to peptidoglycan layer.
- A dense palisade of characteristic long-chain fatty acid known as mycolic acid is the third layer attached to LAM-B membrane.
- A layer composed of mycosides is the outermost fourth layer of the cell wall. Phenolic glycolipid (PGL)-1 is the major component of the outermost layer of the cell wall.

► **Antigenic structure**

*M. leprae* contains a wide variety of mycobacterial antigens. LAM-B is a major antigen of *M. leprae*. LAM-B is highly

immunogenic and induces a high level of serum antibodies. It is distinct from lipoarabinomannose of *M. tuberculosis*.

PGL-1 is the major antigen component of the outermost layer of the cell wall, which is composed of mycosides. The antigen suppresses CMI and protects *M. leprae* from the action of host cell enzymes. The polysaccharides component of PGL-1 antigen induces development of higher antibodies in patients with leprosy.

**Protein antigens:** *M. leprae* consists of a large number of protein antigens. The major protein antigens include (a) 65-kDa heat shock proteins, (b) 28-kDa protein, and (c) 18-kDa protein.

1. The 65-kDa heat shock protein induces a humoral antibody response in the initial phase of *M. leprae* infection. This antibody response continues to persist during various stages of disease including reactional stage.
2. The 28-kDa antigen protein is the superoxide dismutase of *M. leprae*. The protein stimulates a higher antibody response in the lepromatous leprosy than in the tuberculoid leprosy. The antigen also produces even higher antibody response in type 1 reaction.
3. The 18-kDa protein is one of the most important antigens, which produces both humoral and cell-mediated responses in a person. All types of leprosy except tuberculoid leprosy show a high level of antibodies in the serum against 18-kDa antigen.

**Pathogenesis and Immunity**

Leprosy is a chronic granulomatous disease exclusively of humans. Superficial peripheral nerves, skin, mucous membranes of the upper respiratory tract, anterior chamber of the eye, and testis are most commonly affected.

► **Virulence factors**

*M. leprae* is an obligate intracellular acid-fast bacillus with an affinity for macrophages and Schwann cells. The virulence of *M. leprae* is mainly due to:

- Its capabilities for intracellular multiplication and growth and
- Host’s immune system that influences the clinical form of the disease (Table 43-1).

**Phenolic glycolipid-1:** PGL-1 is a prominent surface lipid found on the outermost layer of the cell wall. This lipid is specific to *M. leprae* and is the best-studied virulence factor of *M. leprae* (Table 43-1). PGL-1 binds to C3 component of the

TABLE 43-1

**Virulence factors of *Mycobacterium leprae***

Virulence factors	Biological functions
Phenolic glycolipid-1 (PGL-1)	Protects the lepra bacillus from oxidative killing by macrophages by removing hydroxyl radicals and superoxide anions
The intracellular location of the bacteria	Makes them resistant to killing by phagocytes

complement, which leads to phagocytosis mediated by CR1, CR3, and CR4 receptors found on the cell surfaces. PGL-1 protects the lepra bacillus, once inside the phagocytic cells, from oxidative killing by macrophages by removing hydroxyl radicals and superoxide anions.

### ► Pathogenesis of leprosy

The pathogenesis of the disease leading to tissue damage caused by *M. leprae* infection depends on the following factors:

- CMI of the host,
- Multiplication and extent of spread of lepra bacilli,
- Development of immunological complications such as lepra reaction leading to tissue damage, and
- Development of nerve damage and its sequelae.

Leprosy is primarily transmitted by infected nasal secretions. Infections by a very large number of lepra bacilli lead to lepromatous leprosy. A strong cell-mediated response, however, results in mild form of the disease with low bacterial load and involvement of only few nerves. Therefore, CMI is mainly found in mild form of disease and decreases with the severity of the disease.

Toll-like receptors (TLRs) also play important role in the pathogenesis of leprosy. TLRs, such as TLR-1 and TLR-2, are found on the surface of Schwann cells, especially in patients with tuberculoid leprosy. *M. leprae* activates this receptor on Schwann cells, which is suggested to be responsible for the activation of apoptosis genes and which enhances the onset of nerve damage seen in the mild disease.

A sudden increase in T-cell immunity is also responsible for type 1 reversal reactions. Activation of tumor necrosis factor-alpha and the deposition of immune complexes in tissues with neutrophilic invasion results in type 2 reaction.

Skin and peripheral nerves are commonly involved in leprosy. Although bacilli are also found in the liver, spleen, and bone marrow, no clinical signs of dysfunction of these visceral organs are noted.

The destructive lesions in leprosy, even in most advanced cases, are limited to the peripheral nerves, skin, and upper respiratory passages above the larynx, anterior chamber of the eye, testis, hands, and feet. Higher body temperature or systemic signs of toxicity are absent, although the lepra bacilli are found in the peripheral blood during the disease.

### ► Classification of leprosy

Ridley and Jopling (1966) introduced a system of classification of leprosy on the basis of clinical, histopathological, and immunological findings. This classification is used to differentiate types of leprosy and helps in determining the prognosis following treatment with antileprosy therapy. They classified leprosy into five groups: (a) tuberculoid (TT), (b) borderline tuberculoid (BT), (c) borderline (BB), (d) borderline lepromatous (BL), and (e) lepromatous (LL). Lepromatous leprosy and tuberculoid leprosy are the two extreme or polar forms of the disease.

## Key Points

**Lepromatous leprosy:** This form of leprosy is seen in persons with low CMI.

- The lepra bacilli are seen in large numbers inside the cells or outside the cells. This is known as multibacillary disease. The patients are highly infectious to others.
- Since CMI is absent, lepromin test is negative.
- Tuberculin sensitivity may be negative or suppressed in untreated lepromatous leprosy, but it becomes positive following the treatment.
- In contrast, the humoral immunity is stronger in lepromatous leprosy and is characterized by strong humoral antibody responses. High levels of antibodies are found in the serum. Autoantibodies are also frequently found.
- The skin lesions are usually bilaterally symmetrical and nonanesthetic.

**Tuberculoid leprosy:** This is other end of the spectrum which is seen in patients with stronger CMI.

- Bacilli are scanty or few in the lesions, hence are of minimal infectivity to others.
- Lepromin test is positive.
- Tuberculin sensitivity is positive.
- The humoral antibody response is weak, hence antibodies in the serum is rare.
- Skin lesions are few and the prognosis is good.

The Indian classification of leprosy—borderline tuberculoid, borderline, and borderline lepromatous—usually represents type of leprosy, which shows characteristics of both tuberculoid and lepromatous leprosy. These lesions may progress to either lepromatous or tuberculoid type of lesions depending on the strength of immunity. The lesions heal spontaneously in about 75% of affected persons.

**Purely neuritic leprosy** is an additional form of leprosy described recently. This form is characterized by asymptomatic peripheral neuropathies without any skin lesions. These cases are negative for the bacteria.

### ► Host immunity

*M. leprae* infection induces development of antibody-mediated and cell-mediated immunities in the infected host. The CMI is only protective against the disease. The progression of the disease is primarily dependent on the CMI. The CMI is intact in the tubercular leprosy, whereas it is lacking or minimal in lepromatous leprosy (Fig. 43-1). The infected persons with tuberculoid leprosy show a strong delayed hypersensitivity reaction to lepromin. The macrophages phagocytose the bacilli and destroy them.

### ► Immunogenetics of leprosy

Human leukocyte antigen (HLA) class II serological typing has shown an association of tuberculoid leprosy with DR2 in Indian population. DRB1-1501 and -1502 are the predominant subtypes of DR2 associated with lepromatous leprosy. These two subtypes are implicated in presentation of pathogenic peptides of mycobacteria. DQ1 presentation has been suggested to

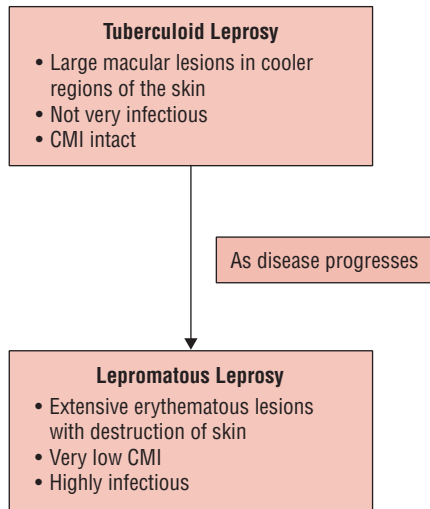

**FIG. 43-1.** Comparison of tuberculoid and lepromatous leprosy.

be associated with an immunosuppression gene for *M. leprae*, since lepromatous leprosy and borderline leprosy have shown an increased frequency of DQ1.

In tuberculoid leprosy, *M. leprae* peptides probably bind selectively to HLA allele forms (HLA-DR2) as well as other positively associated DR antigens and stimulate T-cell clones that result in a harmful immune response. Complete anergy to native heat shock proteins is characteristically seen in lepromatous leprosy.

## Clinical Syndromes

### ► Leprosy

*M. leprae* causes leprosy, a chronic granulomatous disease. The clinical manifestations of leprosy depend on immune status of the host and spread of the bacilli. It is classified into five groups as: (a) tuberculoid leprosy, (b) borderline tuberculoid leprosy, (c) mid-borderline leprosy, (d) borderline lepromatous leprosy, and (e) lepromatous leprosy. The incubation period varies from 6 months to 40 years or longer. The mean incubation period for tuberculoid leprosy is 4 years and for lepromatous leprosy is 10 years.

**Tuberculoid leprosy:** Skin lesions are few. These are usually circular, or serpiginous, sharply demarcated and often hypopigmented. These lesions may have raised and erythematous border with a dry scaly appearance in the center with complete anesthesia. The skin lesions are commonly found on the face, limbs, buttocks, or elsewhere but are not found in the axilla, perineum, or scalp.

Neural involvement is common in tuberculoid leprosy. The ulnar, peroneal, and greater auricular nerves are involved, leading to tender, thickened nerves with subsequent loss of function. Damage of the nerve can result in wrist drop or foot drop.

**Borderline tuberculoid leprosy:** Lesions in this form of leprosy are similar to those seen in the tuberculoid leprosy, but



**FIG. 43-2.** Punched-out lesions seen over the back—borderline leprosy. (Courtesy: Thappa DM. *Textbook of Dermatology, Venereology and Leprology*. 2nd ed. India: Elsevier; 2005, Fig. 32.5.)

are smaller and more numerous. Skin lesions are few, asymmetric, and with nearly complete anesthesia. Peripheral nerves are thickened and involved asymmetrically. This form of leprosy may remain at this stage or can regress to the tuberculoid form; or it can progress to lepromatous form.

**Mid-borderline leprosy:** Skin lesions in this type of leprosy consist of numerous unequally shaped plaques that are less well defined than in the tuberculoid types. These skin lesions are distributed asymmetrically (Fig. 43-2, Color Photo 46). Anesthesia is moderate, and the disease can remain in this stage, can improve, or worsen.

**Borderline lepromatous leprosy:** Skin lesions are moderate to numerous. They are slightly asymmetrical with slight or no anesthesia. Peripheral nerves are enlarged moderately and symmetrical. Like the other forms of borderline leprosy, the disease may remain in this stage, improve, or worsen.

**Lepromatous leprosy:** The skin lesions include macules, nodules, plaques, or papules. The skin lesions are extensive and are bilaterally symmetrical. They are most severe at the cooler parts of the body. This form of disease is associated with disfigurative lesions. The skin of the face and forehead becomes thickened and corrugated, giving rise to typical leonine face. The lateral part of the eyebrows may be lost. Other disfigurative lesions include pendulous ear lobes, hoarseness of voice, involvement of cornea (Color Photo 47), perforation of the nasal septum, and nasal collapse.

Painless inguinal and axillary adenopathy, scarring of testis leading to sterility and gynecomastia are other complications. Diffuse hyperanesthesia involving peripheral parts of extremities also occur due to involvement of the neural tissue.

Differential features of various forms of leprosy are summarized in Table 43-2.

TABLE 43-2

Differential features of various forms of leprosy

	Tuberculoid leprosy	Borderline tuberculoid leprosy	Borderline leprosy	Borderline lepromatous leprosy	Lepromatous leprosy
Lepra bacilli in tissue	–	+/-	+	+++	+++++
Lepra bacilli in nasal secretions	–	–	–	+	++++
Antibodies to <i>Mycobacterium leprae</i>	+/-	+/-	+	+++	++++
Granuloma formation	++++	+++	+	–	–
Lepromin test	++++	+	+/-	–	–
Main phagocytic cell	Mature epithelioid	Immature epithelioid	Immature epithelioid	Macrophage	Macrophage
<i>In vitro</i> correlation of CMI	+++	++	+	+/-	–

### ► Lepra reactions

The course of leprosy may be interspersed with reactional stage, which occurs in one-third of the patients. These reactions are of allergic nature and are acute inflammation of the disease and are known as lepra reactions. These reactions are considered a medical emergency, requiring immediate treatment and management. Such leprosy reactions include: (a) lepra type I (reversal) reaction, (b) lepra type II reaction or erythema nodosum leprosum (ENL), and (c) lucio phenomenon.

**Lepra type I reaction:** Lepra type I reaction is a type IV cell-mediated allergic hypersensitivity. This reaction is seen mostly in patients with borderline leprosy, occurring spontaneously or more often during chemotherapy. These reversal reactions usually suggest a shift toward tuberculoid form after start of chemotherapy. This type I response is precipitated by puberty, pregnancy, and childbirth. This reaction usually occurs during the first 2 months of therapy to up to 12 months. These reactions are characterized by development of skin erythema with edema and tenderness of peripheral nerves.

**Lepra type II reaction:** Lepra type II reactions are type III humoral hypersensitivity reactions with systemic inflammatory response due to deposition of immune complexes. This condition occurs in 20% of patients with lepromatous leprosy and in 10% of patients with borderline leprosy. This reaction occurs after a few years of therapy and relapse intermittently over several years. Appearance of crops of painful erythematous nodules on the skin and subcutaneous tissue is the characteristic manifestation. Fever, malaise, arthralgia, neuralgia, iridocyclitis, arthritis, and proteinuria are other symptoms.

**Lucio phenomenon:** Lucio phenomenon is an unusual form of type II reaction. The condition manifests as cutaneous hemorrhagic infarct in patients with diffuse lepromatous leprosy. This condition is commonly documented in Mexico and Central America.

### Epidemiology

Leprosy is a disease prevalent worldwide.

### ► Geographical distribution

The worldwide prevalence of leprosy is <1 case/10,000 population. Most cases of leprosy are found in Southeast Asia, Africa, and the Americas. Fifteen endemic countries in these areas have a prevalence of >1 case/10,000 populations. Leprosy is most endemic in Brazil, Angola, Central African Republic, Congo, Madagascar, Mozambique, Tanzania, Nepal, and India. Approximately 74% of these cases are found in these nine countries. Lepromatous leprosy is more prevalent in Africa, while tuberculosis is more frequent in Asia. In India, leprosy is present in all states and territories. Orissa and Bihar have a higher prevalence of more than 5 cases/1000 population, whereas Haryana has the least (0.1/1000 population). Overall, the prevalence of the disease has decreased since the introduction of short multidrug therapy in 1982.

### ► Habitat

In infected host, *M. leprae* is found in large number in infected nasal secretions of patients with lepromatous leprosy.

### ► Reservoir, source, and transmission of infection

Leprosy is an exclusively human disease. Humans are the prime reservoir of *M. leprae*. Nine-banded armadillo, chimpanzee, and mangabey monkeys are the three animal species known to be important animal reservoirs of leprosy. Leprosy is not a highly infectious disease. Lepromatous forms of the disease, but not the tuberculoid form, is infectious.

Nasal secretions from patients with lepromatous leprosy are important source of infection. Very large numbers of lepra bacilli are shed in the nasal secretions. As high as  $8 \times 10^8$  bacilli can be discharged during a single act of nose blow of the patients with untreated lepromatous leprosy.

Inhalation of infectious aerosol and skin contact with respiratory secretions or wound exudates are the most important routes of infection in leprosy. The following observations support transmission of infection through the respiratory route:

- Large numbers of morphologically intact lepra bacilli are demonstrated in the nasal discharges.
- The organisms have not been detected on the surface of the skin.

- Lepra bacilli survive for several hours or days outside the human host.
- Experimental transmission of leprosy has been achieved by aerosols containing *M. leprae* and by topical application in immunosuppressed mice.

Leprosy is usually not spread by means of direct contact through intact skin, though close contacts are more susceptible.

Lepromatous leprosy is more common in men than women, with a male to female ratio of 2:1. Tuberculoid leprosy predominates in children. The disease is rare in infants.

## Laboratory Diagnosis

The diagnosis of leprosy is essentially clinical. Laboratory diagnosis of leprosy is essentially based on demonstration of acid-fast *M. leprae* in the skin smears by microscopy. They are helpful in making definitive diagnosis of leprosy. This is supplemented by skin test and newer molecular diagnostic techniques.

### Specimens

In lepromatous leprosy, lepra bacilli are always found in large numbers in the skin and in the nose. Therefore, smears collected from the nasal mucosa, skin lesions, and ear lobules are the specimens of choice for microscopy. Occasionally, the specimens may be collected from lymph nodes and affected nerves in lepromatous leprosy. In tuberculoid leprosy, the bacilli are not found in these specimens.

**Skin smears:** The skin smears are collected from the leprosy lesions, such as nodules, thick papules, and areas of infiltration. In cases of patches, the samples are obtained from the edge of the lesion rather than from the center. In patients with only diffuse infiltrations, skin smears are collected from five to six different sites including the skin over the ear lobes, buttocks, forehead, cheeks, and chin.

**Slit and scrap method:** The skin smears from these sites are collected by slit and scrap method. In this method, the skin is pinched up and raised between the thumb and index finger of the left hand, which squeezes out blood from that part, thereby minimizing bleeding when a cut is made. Then with the help of a scalpel, a cut about 5 mm is made on the pinched skin, deep enough to get into the infiltrated layers. After wiping of blood or lymph that may have exuded, the blade of the scalpel is turned at right angle to the cut and the sides and bottom of the cut are scraped with point of the blade several times in the same direction, so that the tissue fluid and pulp but not blood are collected on one side of the blade. Obtained fluid and tissues are thickly spread on a slide and stained by Ziehl-Neelsen (ZN) technique.

**Nasal smears:** Smears from the nasal patches are collected by scraping material from the mucous membrane of the internal nasal septum, particularly from inferior turbinate folds of the nasal septum. This mucous membrane is then spread on a slide and a uniform smear is made, which is stained by ZN method as mentioned earlier.

### Microscopy

The slit-skin smears, nasal smears, or smears from other specimens on the slide are stained by using the ZN method and partially decolorized with 5% instead of 20% sulfuric acid. In a positive, stained smear, red-colored acid-fast bacilli are seen on examination by oil immersion lens (Fig. 43-3, Color Photo 48). The smears are graded based on the numbers of bacilli as mentioned in Table 43-3.

Bacillary index and morphological index are two indices, which are based on demonstration of *M. leprae* in smears from skin or nasal discharges. These two indices are useful for:

- Demonstrating viability of organisms,
- Assessing amount of infection, and
- Assessing the progress of patients after treatment with chemotherapeutic agents.

**Bacillary index:** The bacillary index or BI is an expression of the extent of bacterial load. It is calculated by counting six to eight stained smears under the 100× oil immersion lens. This index is obtained by totaling the number of plusses (plus scored in all the smears and divided by the number of the smears). For example, if six smears showed a total of 12+, the bacillary index will be 2. For this index, a minimum of four skin lesions, a nasal swab, and both ear lobes are examined. The bacillary index is usually affected by the thickness of the film, depth of the skin incision, and thoroughness of the scrap (Table 43-3).

**Morphological index:** The uniformity of the bacilli is used as a criterion to differentiate live bacilli from dead bacilli in stained smears. It is calculated by counting solid stained bacilli out of the total number of bacilli counted. The lepra bacilli that stain uniformly with carbol fuchsin as solid acid-fast rods are believed to be viable, and the bacilli that stain irregularly are considered dead and degenerated. The percentage of uniformly stained bacilli in the tissues is known as morphological index (MI).

This index is a useful method for assessing the response of patients of leprosy with antileprosy agents, and is more useful than the bacteriological index (BI). A decrease in the MI indicates better response of the patients to chemotherapy, whereas a decrease in MI followed by an increased MI indicates

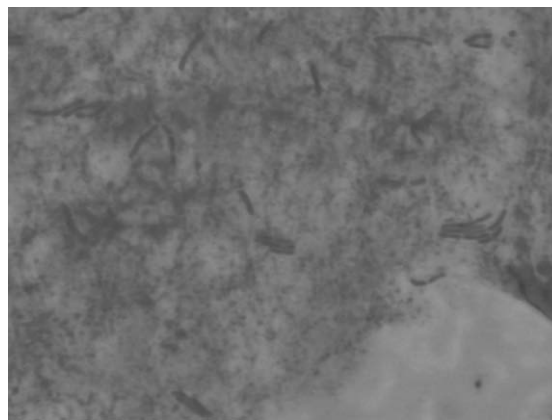

FIG. 43-3. Slit-skin smear showing acid fast *Mycobacterium leprae*.

TABLE 43-3

## Grading of ZN-stained smears for lepra bacilli

Examination by oil immersion field	Number of AFB	Interpretation
100 Fields	1–10 bacilli/100 fields	1+
10 Fields	1–10 bacilli/10 fields	2+
1 Field	1–9 bacilli in every field	3+
1 Field	10–100 bacilli in every field	4+
1 Field	100–1000 bacilli in every field	5+
1 Field	> 1000 bacilli in every field	6+

AFB, acid-fast bacilli.

poor response to chemotherapeutic agents due to development of drug resistance in the bacteria.

The other methods that are also useful in detecting viable lepra bacilli include (a) fluorescent diacetate–ethidium bromide (FDA–EB) staining, (b) laser microscope mass analysis (LAMMA), bioluminescent technology, and (c) macrophage-based assays.

### Key Points

- Nasal smears are positive in lepromatous leprosy and borderline leprosy but are negative in tuberculoid leprosy, mid-borderline leprosy, and borderline tuberculoid leprosy.
- Examination of nasal smears is useful to know whether a leprosy patient is infectious or not.
- The lepra bacilli usually disappear more rapidly from the nose than from the skin lesions following chemotherapy.



### Biopsy

**Skin biopsy** is useful for the diagnosis and proper classification of leprosy. The samples are usually obtained from the edge of the lesion; a biopsy smear or scalpel may be used for the purpose.

**Nerve biopsy:** Nerve biopsy is a very useful method in the diagnosis of leprosy:

- This is useful to differentiate lepromatous cause of thickened nerves from other nonlepromatous causes of thickened nerves in people residing in endemic areas for the disease.
- This is useful to rule out other diseases, such as polyradiculoneuropathy, hereditary neuropathies, or polyarteritis nodosa.
- This is the only method to confirm diagnosis in cases of leprosy with pure neuropathic forms.
- The nerve biopsy occasionally shows abnormalities, even in contacts of patients with leprosy.

### ► Lepromin test

The lepromin test is used to study host immunity to *M. leprae*. The test was first described by Mitsuda in 1919. The test is an intradermal skin test performed by using lepromin antigen, which is a suspension of killed *M. leprae* obtained from infected human or armadillo tissue.

**Antigen:** Originally, crude antigen obtained from human lepromatous tissue rich in *M. leprae* was used as antigen. This antigen was first prepared by Mitsuda in 1919 by using antigens extracted from skin lesions of lepromatous patients. This antigen known as standard Mitsuda lepromin contains  $4.0 \times 10^7$  *M. leprae* per mL, which have a shelf life of 2 years when stored at 4°C. Recently, the standard lepromin antigen is being prepared from armadillo derived lepra bacilli (Lepromin A) by replacing human derived lepra bacilli (Lepromin H).

**Dharmender's antigen:** Bacillary lepromin is another type of antigen, which contains more of bacillary components and less of tissue components. Dharmender's antigen is an example of such antigen. This antigen was first prepared by Indian scientist Dharmender by separating the bacilli from finely ground lepromatous tissue and treating with chloroform. The suspension is then evaporated to make it dry and then washed with ether to remove the lipids. The antigen, finally, is reconstituted in phenol saline for use. However, more recently, soluble antigens from *M. leprae* have also been used as antigens in the skin test.

**Test:** Lepromin skin test is performed by intradermal injection of lepromin antigen into the forearm. Two types of reactions are observed after the test. First, early or Fernandez reaction and second, late or Mitsuda reaction.

**Early or Fernandez reaction** is observed after 48 hours of injection. Positive reaction is characterized by the appearance of a localized area of inflammation with congestion and edema measuring 10 mm and more in diameter during 24–48 hours of injection. These lesions disappear within 3–4 days. The positive Fernandez reaction, like tuberculin reaction indicates delayed type of hypersensitivity to antigens of *M. leprae* or mycobacteria that cross-react with *M. leprae*. Positive reaction suggests that the patient has been infected by lepra bacilli during sometime in the past.

**Late or Mitsuda reaction** is characterized by development of a nodule at the site of inoculation after 3–4 weeks of injection (Fig. 43-4). The nodule subsequently may undergo necrosis followed by ulceration. The ulcer takes several weeks to heal. Positive Mitsuda reaction is the manifestation of CMI, which indicates that the immune system is capable of inducing an efficient cell-mediated response. This Mitsuda reaction is positive in tuberculoid leprosy.

### Key Points

The lepromin test is used mainly to:

- **determine** the type of leprosy, being positive (suggests resistance to disease) in tuberculoid leprosy and negative (suggests a lack of resistance to the disease) in lepromatous leprosy patients;
- **monitor** response of leprosy patients to treatment with chemotherapy. A positive reaction indicates a good prognosis while a negative test suggests a very bad prognosis;
- **evaluate** host resistance to leprosy.



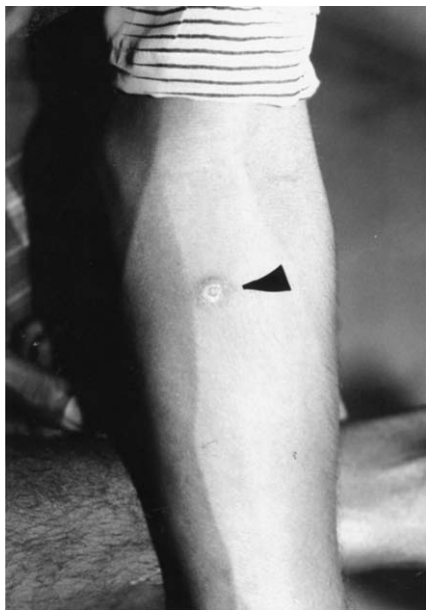

**FIG. 43-4.** Lepromin test (forearm) showing Mitsuda reaction in the form of a papule. (Courtesy: Thappa DM. *Textbook of Dermatology, Venereology and Leprology*. 2nd ed. India: Elsevier; 2005, p. 47, Fig. 5.17.)

The lepromin test is not used to confirm the diagnosis of leprosy. It is also not useful to indicate prior contact of the person with leprae bacilli. Healthy people residing in areas non-endemic for leprosy with no chance of contact with the bacilli may show a positive lepromin reaction.

### ► Serodiagnosis

Serodiagnosis of leprosy is based on demonstration of antibodies to *M. leprae*, specific PGL-1 antigens. Enzyme linked immunosorbent assay (ELISA) and latex agglutination test are used to detect serum antibodies. The serology is useful primarily in patients with untreated lepromatous leprosy, as most (90%) of patients have higher levels of serum antibodies. The serology, however, is less useful for diagnosis of paucibacillary disease, because serum antibodies are present in only 40–60% of such patients.

### Molecular Diagnosis

Polymerase chain reaction (PCR) for identifying DNA that encodes 65- and 18-kDa *M. leprae* proteins and repetitive sequences of *M. leprae* is being used to detect and identify *M. leprae* in clinical specimens.

- PCR is used to monitor treatment, diagnose relapses, or determine the need for chemotherapy.
- The technique is most useful in cases of leprosy showing atypical clinical or histopathological features but positive for acid-fast bacilli.
- It is not useful for diagnosis of cases when acid-fast bacilli are not detected by light microscopy.

## Treatment

The management of leprosy depends on treatment by chemotherapeutic agents, immunotherapy, and physical, social, and psychological rehabilitation.

### ► Chemotherapy

The goals of chemotherapy against leprosy are to (a) stop infection, (b) reduce morbidity, (c) prevent complications, and (d) eradicate the disease. Dapsone was the first effective chemotherapeutic agent used against leprosy. Earlier it was used as a monotherapy, but it resulted in development of resistance against the drug by lepra bacilli. Hence since 1981, the World Health Organization (WHO) has advocated multiple drug therapy (MDT) against leprosy, as in tuberculosis.

**Multiple drug therapy (MDT) against leprosy:** The MDT quickly decreases contagiousness of the disease, reduces relapse and reactions, and reduces disabilities. Moreover, MDT prevents dapsone resistance. The duration of treatment varies from 6 months to 2 years. The recommendations of WHO for treatment of leprosy in adults are as follows:

1. **Single skin lesion:** A single dose of the drug which includes rifampicin 600 mg, ofloxacin 400 mg, and minocycline 100 mg.
2. **Paucibacillary disease:** Dapsone 100 mg daily and rifampicin 600 mg once a month given for 6 months.
3. **Multibacillary disease:** Rifampin (rifampicin) 600 mg once a month, dapsone 100 mg daily, clofazimine 300 mg once a month, and 50 mg daily are given for 1 year.

A minimum 2 years follow-up for paucibacillary and 8 years for multibacillary cases is required to detect any relapse. Treatment schedule for children consists of dapsone (2 mg/kg) daily, clofazimine (6 mg/kg) once a month under supervision and 1 mg/kg daily self-administered, and rifampin (10 mg/kg) once a month.

Reactions during treatment with MDT are a major problem. These reactions need urgent treatment, failing which they can give rise to irreversible deformities. Early diagnosis and timely initiation of anti-inflammatory measures are important. MDT is not stopped during reactions and continued at full doses without interruption.

### ► Immunotherapy

Many immunotherapy agents have been evaluated for treatment of leprosy. These include immunomodulatory drugs, transfer factor, acetoacetylated *M. leprae*, and delipidified cell components of *M. leprae*. These agents have shown to enhance CMI, which results in increased killing and rapid clearing of dead lepra bacilli. Immunotherapy in combination with chemotherapy has shown to be more beneficial, better tolerated by patients, and is not associated with increased lepra reactions.

## Prevention and Control

The preventive and control measures include: (a) early diagnosis and treatment of leprosy and surveillance of contacts, (b) health education, (c) vaccines, and (d) chemoprophylaxis.

### ► Early diagnosis and treatment of leprosy and surveillance of contacts

No skin or serologic tests are available to identify a carrier of leprosy. It is essential to monitor household contacts of patients with lepromatous disease annually for 5 years after diagnosis.

### ► Health education

It is important in prevention and control of leprosy in population.

### Vaccines

Attempts have been made to develop and evaluate vaccines against leprosy. The antileprosy vaccines can be used as both immunoprophylactic and therapeutic agents. The vaccines that have been evaluated currently include the *Mycobacterium avium*-intracellulare complex (*Mycobacterium* ICRC) vaccine, bacille Calmette–Guérin (BCG) vaccine; *Mycobacterium w* vaccine; BCG plus heat-killed *M. leprae*, *Mycobacterium tufo*, and *Mycobacterium habana* vaccine.

The BCG vaccine has shown variable results in conferring protection against certain populations; therefore, it is not widely used. However, repeat immunization with BCG has shown to confer further protection. Both *Mycobacterium w* and *Mycobacterium* ICRC vaccines are used in India. *Mycobacterium* ICRC vaccine was prepared in 1979 and contains gamma-radiation-inactivated ICRC bacilli. Uses of these vaccines—both in mouse model and human studies—have shown better results.

### ► Chemoprophylaxis

Many studies using one or more antileprosy drugs (dapsone, acedapson, and rifampicin) as chemoprophylaxis against leprosy have failed to show any significant protection against leprosy. Therefore, at present, detection and MDT for all patients with leprosy is the useful method for early prevention of leprosy.

## *Mycobacterium lepraemurium*

*M. lepraemurium* was first described by Stefansky as the causative agent of leprosy in rats in 1901 at Odessa. The rat leprosy was found in 4–5% of slaughtered rats investigated during an attack of human plague. The condition, subsequently, has been documented with variable incidence from different countries of the world. *M. lepraemurium* resembles *M. leprae* and is found in the mononuclear cells of the subcutaneous tissues, lymph nodes, and in the nodules in the lungs and liver of the infected rat. However, both *M. lepraemurium* and *M. leprae* are not related species, and they differ from each other as shown by DNA studies.

*M. lepraemurium* is cultivated with difficulty in Ogawa's egg-yolk medium (pH 5.8–6.3) at 37°C and also in rat fibroblasts cell lines.

*M. lepraemurium* in rats causes rat leprosy, which is characterized by two forms: glandular form and musculocutaneous form. Enlarged, hard, and whitish inguinal, axillary, and cervical lymph nodes are found in the glandular type, and ulceration and loss of hair are found in the musculocutaneous type. The bacteria do not cause disease in humans.



### CASE STUDY

A 25-year-old male attended Dermatology OPD and complained of hypopigmented patches on limbs and few on the buttocks. On examination, the ulnar nerve was found to be tender and thickened. Skin biopsy and nasal secretion were negative for acid-fast bacilli. Lepromin test was positive. The condition was diagnosed as leprosy.

- Diagnose the type of leprosy patient is suffering from.
- Describe the laboratory methods for diagnosis of the condition.
- Discuss the antibiotic regimen for treatment of the condition.
- Describe the vaccines available against the disease.

# Treponema, Borrelia, and Leptospira

## Introduction

Spirochetes have been classified in the order Spirochaetales. They vary in size from 5 to 500  $\mu\text{m}$  in length. Many of them are free-living saprophytes, while a few are obligate parasites. They may be aerobic, anaerobic, or facultative. Spirochetes show common morphological properties. They are thin, helical (0.1–0.5  $\times$  5–20  $\mu\text{m}$ ), and Gram negative. They are also elongated, motile, and flexible bacteria, twisted spirally along the long axis, giving these bacteria the name spirochetes (*Spira* meaning coiled, *chait* meaning hair). The presence of endoflagella is the characteristic feature of spirochetes. Endoflagella are the polar flagella situated between the outer membrane and cell wall, and are responsible for spiral shape and motility of the spirochetes. Spirochetes exhibit three types of motility: (a) flexion and extension, (b) corkscrew-like rotatory movement, and (c) translatory motion.

The order Spirochaetales is subdivided into two families: Spirochaetaceae and Leptospiraceae. The family Spirochaetaceae consists of four genera: *Spirochete*, *Cristispira*, *Treponema*, and *Borrelia*. The genera *Treponema* and *Borrelia* include pathogenic species, which cause diseases in humans. Members of the genus *Cristispira* are found in molluscs, while *Spirochetes* are saprophytes found in sewage and water. Family Leptospiraceae contains only one genus *Leptospira*, which consists of species pathogenic to humans. The spirochetes causing disease in humans are summarized in Table 44-1.

## Treponema

The generic name *Treponema* is derived from the Greek word *Trepos*, meaning to turn and *nema*, meaning thread. The treponemes are short and slender spirochetes with fine spirals and

TABLE 44-1

**Human infections caused by most common spirochetes**

Bacteria	Diseases
<i>Treponema pallidum</i> subsp. <i>pallidum</i>	Syphilis
<i>Treponema pallidum</i> subsp. <i>endemicum</i>	Bejel and endemic syphilis
<i>Treponema pallidum</i> subsp. <i>pertenue</i>	Yaws
<i>Treponema carateum</i>	Pinta
<i>Borrelia recurrentis</i>	Epidemic relapsing fever
Many <i>Borrelia</i> species	Endemic relapsing fever
<i>Borrelia burgdorferi</i>	Lyme disease
<i>Leptospira interrogans</i>	Leptospirosis

pointed ends. Some of them are pathogenic for humans, while others occur as commensals in the mouth, intestine, and genitalia. Pathogenic members of the genus include *Treponema pallidum* (with three subspecies) and *Treponema carateum*. All these species:

- are morphologically identical,
- produce same serological responses in infected humans, and
- are sensitive to penicillin.

These species, however, differ in their:

- clinical manifestations,
- natural history of the disease they cause, and
- epidemiological features.

As for recent nomenclature and taxonomical studies, species *T. pallidum* consists of *T. pallidum* subsp. *pallidum* causing venereal syphilis, *T. pallidum* subsp. *endemicum* causing endemic syphilis or bejel, *T. pallidum* subsp. *pertenue* causing yaws, and *T. carateum* causes pinta. In this book, *T. pallidum* subsp. *pallidum* is referred to as *T. pallidum*, *T. pallidum* subsp. *pertenue* as *T. pertenu*, and *T. pallidum* subsp. *endemicum* as *T. endemicum* for the sake of familiarity.

## Treponema pallidum

*T. pallidum* is the causative agent of syphilis, the most common sexually transmitted disease.

## Properties of the Bacteria

### ► Morphology

*T. pallidum* shows the following morphological features:

- *T. pallidum* is a thin, coiled spirochete. It measures 0.1  $\mu\text{m}$  in breadth and 5–15  $\mu\text{m}$  in length.
- It has six to ten sharp and angular coils, which are present at regular interval of 1  $\mu\text{m}$ .
- It is actively motile. Endoflagella are responsible for motility of the bacteria. It shows three types of motility: flexion of the whole body, backward and forward movement, and rotation around the long axis. As the *Treponema* moves, it shows a series of secondary curves, which appear and disappear but its primary spiral structure remains unchanged.
- *T. pallidum* is too thin to be seen by microscopy in specimens stained by simple Gram or Giemsa staining. It is stained by silver impregnation method, which makes the bacteria

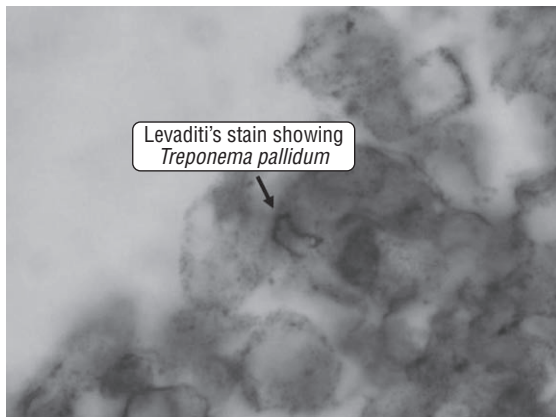

**FIG. 44-1.** Levaditi's silver impregnation staining method showing *Treponema pallidum* ( $\times 1000$ ).

thickened by deposition of silver compounds during the process of staining. Levaditi's method (Fig. 44-1) and Fontana's method are the examples of silver impregnation staining methods, which are useful for staining tissue sections and blood films, respectively.

- Dark ground or phase contrast microscopy is useful for demonstrating the morphology and motility of live *T. pallidum*.
- *T. pallidum* on electron microscopy shows a trilaminar cytoplasmic membrane surrounded by a cell wall. The latter contains peptidoglycan that confers the cell its shape and rigidity. The cell wall is surrounded by an outer membrane layer.
- Three, occasionally four flagella known as endoflagella, responsible for motility of bacteria, originate from each end of the cell and extend toward the opposite end of the cell in the space between cell wall and outer membrane layer. These endoflagella do not extend beyond the cell wall outside but remain always confined within the outer membrane layer.

### ► Culture

*T. pallidum* does not grow in artificial culture media. *T. pallidum* had been maintained for a long time by subculture in animals.

**Nichole's strain of *T. pallidum*:** It is a pathogenic strain, which has been maintained for several decades by serial passage in rabbit testes. This strain was isolated in 1913, originally from the brain of a fatal case of a patient with general paralysis of insane. This strain is most commonly used for diagnostic and research purposes in the laboratory. Strains of *T. pallidum* have been maintained for a short period in cell lines, such as Eagle and McCoy cell lines supplemented with fetal bovine serum and reducing agent.

### Key Points

- *Treponema phagedenis* (earlier known as Reiter's treponema) and *Treponema refringens* are the examples of nonpathogenic treponemes.
- These treponemes can be grown in Smith-Noguchi medium or in digest broth enriched with serum under strict anaerobic conditions.
- Reiter's strain is widely used for preparation of antigen for use in group-specific treponemal tests for diagnosis of syphilis.

### ► Other properties

**Sensitivity to physical and chemical agents:** *T. pallidum* is a very delicate bacterium. It is readily killed by drying or heating at 41–42°C for 60 minutes, at 0–4°C for 1–3 days. They are also readily killed on contact with distilled water, soap, arsenic compounds, mercuric compounds, bismuth compounds, and common antiseptics. *T. pallidum* strains can be preserved for laboratory use by many methods. It can be stored frozen in a medium containing 5% glycerol at 70°C or in liquid nitrogen at –130°C for 10–15 years.

### Cell Wall Components and Antigenic Structure

*T. pallidum* is antigenically complex. Infection by the bacteria induces production of at least three types of antibodies against (a) cardiolipin antigen, (b) group-specific antigens, and (c) species-specific antigens of *T. pallidum*.

### ► Cardiolipin antigen

The cardiolipin antigen is a hapten and is chemically a diphosphatidyl glycerol. This hapten elicits the production of an antibody, known as reagin antibody, in blood of patient suffering from syphilis. This cardiolipin antigen is demonstrated in *T. pallidum*, but it is not known whether the reagin antibody is produced by cardiolipin that is present in the treponema or by the cardiolipin that is released from damaged tissues following infection by treponema.

Demonstration of the reaginic antibodies in the serum against the cardiolipin antigen forms the basis of standard non-specific tests for syphilis (e.g., VDRL, Kahn, and Wasserman).

### ► *T. pallidum* group-specific antigen

*T. pallidum* group-specific antigen is protein in nature. It is found in *T. pallidum* as well as in nonpathogenic cultivable treponemes, such as Reiter's treponeme. This antigen induces the production of antibodies in the serum, which are found in patients with syphilis. Reiter's protein complex complement fixation test, a test used in syphilis serology, employs this antigen for detection of serum antibodies in patients with syphilis.

### ► *T. pallidum* species-specific antigen

Species-specific treponemal antigen is probably polysaccharide in nature. This antigen induces the development of antibodies, which can be detected in serum of the patients suffering from syphilis. The specific treponemal test, such as *T. pallidum* hemagglutination (TPHA) test, detects antibodies by using these antigens.

### Pathogenesis and Immunity

*T. pallidum* is a strict human pathogen.

### ► Virulence factors

The virulence of *T. pallidum* has recently been studied by cloning of *T. pallidum* genes in *Escherichia coli* and demonstrating

TABLE 44-2

**Virulence factors of *Treponema pallidum***

Virulence factors	Biological functions
Outer membrane proteins	Promote adherence of <i>T. pallidum</i> to the surface of host cells
Enzyme hyaluronidase	Facilitates perivascular infiltration
Fibronectin	Prevents phagocytosis of <i>T. pallidum</i> by macrophages

various proteins. Although many proteins have been isolated from pathogenic treponemes, the exact role of these proteins in pathogenesis of the disease still remains unclear. The possible virulence factors of *T. pallidum* include the following (Table 44-2):

- 1. Outer membrane protein:** Outer membrane protein of *T. pallidum* appears to play an important role in virulence of the bacteria. It promotes adherence of *T. pallidum* to the surface of host cells, thereby facilitating the infection.
- 2. Enzyme hyaluronidase:** This enzyme, produced by only pathogenic treponemes, may facilitate perivascular infiltration.
- 3. Fibronectin:** Host cell fibronectin forms a coating on the surface of pathogenic *Treponema*, thereby preventing it from phagocytosis by macrophages.

► **Pathogenesis of syphilis**

*T. pallidum* causes disease by invasion and multiplication at the site of infection, then spreading via circulation and producing disseminated disease. Immune response of the host is believed to be responsible primarily for tissue destruction and for causing pathogenic lesions observed in patients with syphilis.

On sexual contact, *T. pallidum* from infected partner is passed to another partner through intact mucous membrane or through minor skin abrasions. The organisms invade the skin at these lesions and multiply at the site of infection. *Chancre* is the primary lesion, which develops at the site of infection. Subsequently, the treponemes get transmitted in the blood stream and produce disseminated lesions (papular skin rashes, mucous patches in the oropharynx, etc.).

During the course of infection, the condition may progress to the late stage of the disease and possibly all tissues are affected by *T. pallidum*. Every stage of the disease—whether primary, secondary, or late—represents localized multiplication of the treponemes and destruction of the tissues.

► **Host immunity**

The treponemes rapidly penetrate the intact mucous membrane or minor skin abrasions and within a few hours enter the lymphatics and blood to produce a systemic infection. Treponemal antigens induce the production of specific treponemal antibodies and nonspecific reaginic antibodies and relapsing fever. These also induce development of cell-mediated immunity.

Immunity in syphilis is incomplete. For example, both humoral antibodies and cell-mediated immunity prevent the formation of chancre, a primary lesion on reinfection with

*T. pallidum*, but they do not clear the organisms from the sites of infection. Their failure to kill the organism, possibly:

- is due to the presence of outer layer of the *Treponema*, which lack immunogenic molecules or
- it may be due to downregulation of helper T cells of the T<sub>H1</sub> class.

**Clinical Syndromes**

*T. pallidum* causes following clinical syndromes:

1. Venereal syphilis (transmitted by sexual contact)
2. Nonvenereal syphilis (congenital syphilis and occupational syphilis)

► **Venereal syphilis**

Syphilis, if remains untreated, progresses through these distinct characteristic stages as follows:

**Primary syphilis:** This condition occurs within 3 weeks of sexual contact with an infected host. Chancre is the primary lesion seen during this stage of the disease (Fig. 44-2). It is a single or solitary lesion with a surrounding areola. The edge and base of the ulcer have a button-like consistency on palpation. The lesion occurs on penis or on scrotum of 75% of men and on the vulva, cervix, or perineum of more than 50% of women suffering from syphilis. The chancre is highly infectious. The exudates of the chancre contain numerous *T. pallidum* bacteria.

**Secondary syphilis:** Secondary syphilis occurs 2–10 weeks after the primary chancre and is most florid 3–4 months after infection. This stage of the disease is characterized by the



**FIG. 44-2.** Primary chancre. (Courtesy: Thappa DM. *Textbook of Dermatology, Venereology and Leprology*. 2nd ed. India: Elsevier; 2005, p. 277, Fig. 27.1.)

presence of mucocutaneous lesions, which are discrete, macular pink to red, and measure 3–10 mm in diameter.

The cutaneous lesions may vary from macular to papular, pustular, and nodular type. The papules in the moist area of the skin of the body folds, especially about the anus (Color Photo 49) and genitalia, subsequently become broad, flat, and pink in color, leading to the formation of so-called condylomata lata. The lesions are found in the entire body including the palms, sole, and other sites.

This condition is associated with mild symptoms of headache, nausea, fever, and pain in the bones. Painless generalized lymphadenopathy is seen in nearly 85% of the patients.

**Tertiary syphilis:** The condition develops within 3–10 years of infection. Gumma is a typical pathological lesion found on the skin, in the mouth, and in the upper respiratory tract. Gummatous lesions may be multiple or diffuse, but are usually single lesions, which measure from 1 cm to several centimeters in diameter. This tertiary lesion contains few spirochetes and represents manifestations of delayed hypersensitivity.

Cardiovascular syphilis, chronic granulomatous and meningovascular manifestations, and neurosyphilis (Tabes dorsalis, general paralysis of insane) are the other manifestations of syphilis, which occur several decades after the infection.

### ► Nonvenereal syphilis

Congenital syphilis and occupational syphilis are example of nonvenereal syphilis.

**Congenital syphilis:** It is the most severe outcome of syphilis in humans. The infection occurs by vertical transmission from mother to fetus during pregnancy. If the mother is suffering from secondary syphilis and not treated for the same, a higher proportion of infants are affected compared to untreated early latent syphilis. In more than 40% of untreated maternal infection, *T. pallidum* causes late abortion, still birth, and death. Deaths in neonates may occur due to secondary bacterial infection, fulminant hepatitis, or pulmonary hemorrhage.

The infants suffering from congenital syphilis are born usually without any overt clinical manifestation of the disease. Poor feeding and rhinitis may be the earliest signs of congenital syphilis. Manifestations of the late onset congenital syphilis include neurosyphilis and involvement of the eighth cranial nerve, teeth, and bones.

**Occupational syphilis:** It is a condition that may occur in medical and paramedical workers handling a case of secondary syphilis. The lesion develops usually on the palm of infected health workers and may also occur on other exposed body part.

## Epidemiology

Syphilis is a sexually transmitted disease found worldwide.

### ► Geographical distribution

Syphilis occurs worldwide, mostly in large cities. The disease is extremely common in areas of dry, hot climates. Also, it is common in areas of poor economic status, education, and

personal hygiene. The condition is prevalent in parts of Africa (e.g., Sudan, Southern Rhodesia, South Africa), parts of the Middle East (e.g., Nomadic/Bedouin tribes of Saudi Arabia, Iraq, and Syria), and parts of Asia (e.g., Turkey, Southeast Asia, the Western Pacific) and India.

### ► Habitat

*T. pallidum* inhabits the genital tract of infected males and females.

### ► Reservoir, source, and transmission of infection

*T. pallidum* is a strict human pathogen and does not naturally occur in any animal species. Humans are the only natural hosts. Infected human hosts secreting *T. pallidum* in serous transudates from moist lesions, such as primary chancre, condyloma latum, mucous patch, etc., are the sources of infection. Transmission of syphilis occurs:

- Primarily through sexual contact by inoculation of the spirochetes through mucosal membranes and abrasions on epithelial surfaces.
- By vertical transmission transplacentally. Vertical transmission of early syphilis during pregnancy results in a congenital infection in at least 50–80% of exposed neonates.
- By transfusion of *T. pallidum*-contaminated blood.

Unprotected sex, promiscuous sex, and intravenous drug use are the major risk factors for syphilis. Doctors, nursing staff, and other healthcare workers are at occupational risk.

Syphilis in persons with human immunodeficiency virus (HIV) infection is a problem increasingly recognized recently. Concomitant HIV and syphilis are common. Serological tests for syphilis may be modified by the presence of HIV, usually resulting in extremely high antibody titers, which do not decrease in response to adequate treatment.

## Laboratory Diagnosis

Since the clinical manifestations of the syphilis are protean, laboratory tests play an important role to confirm diagnosis of the disease.

### ► Specimens

Specimens for microscopy include serous transudates from moist lesions, such as primary chancre, condyloma latum, mucous patch, etc. Serum is used for serodiagnosis, and cerebrospinal fluid (CSF) is used for diagnosis of neurosyphilis.

### ► Microscopy

Dark-field microscopy is useful for diagnosis of primary, secondary, or congenital syphilis by demonstration of treponemes in the clinical specimen. Dark-field microscopy is particularly helpful for diagnosis early in the disease before the appearance of serum antibodies. *T. pallidum* is identified by its slender spiral structure and slow movement. Dark-field microscopy, although useful, has many limitations. First, it is reliable only when examined by an experienced microscopist. Second, the method is of low sensitivity because as high as  $10^4$  bacteria/mL

of the exudates need to be present for demonstration by dark ground microscopy.

Specimens from oral cavity cannot be used because saprophytic nonpathogenic treponemes are present as normal flora of the oropharynx.

### ► Direct antigen detection

Direct fluorescent antibody *T. pallidum* (DFA-TP) is a sensitive and better method for direct detection of treponemal antigen in the exudates for diagnosis of syphilis. The test using fluorescent-tagged *T. pallidum* antibodies is used to detect treponemal antigen directly in the acetone-fixed smears of the exudates. The test is 85–92% sensitive.

### ► Culture

Since *T. pallidum* cannot be cultured on artificial medium, culture is not used for diagnosis of syphilis.

### ► Serodiagnosis

Serology is the mainstay in the diagnosis of syphilis. It is extensively used for diagnosis of the condition in most of the laboratories. The serological test depending on the nature of the antigen used can be classified as (a) nontreponemal tests and (b) treponema-specific tests.

#### Nontreponemal tests

Nontreponemal tests are nonspecific serological tests used for the diagnosis of syphilis. These tests are also called standard tests of syphilis (STS). This group of tests use nontreponemal antigen (known as cardiolipin) and detect reagin antibodies.

### Key Points

#### Reaginic antibodies

- The reaginic antibodies are produced against lipid antigens present on the surface of treponemes, or produced as a result of damage of the infected host cells during early stage of the disease.
- The reaginic antibodies appear 7–10 days after appearance of the primary chancre or 3–5 weeks after active infection in primary syphilis. The antibodies also develop in syphilitic patients with secondary and latent diseases.
- These antibodies do not appear in early primary syphilis, latent acquired syphilis of long duration, and late congenital syphilis. Therefore, Venereal Disease Research Laboratory (VDRL) and other tests may show false negative reactions during these conditions.

Prozone phenomenon occurs (a) in approximately 2% of patients with secondary syphilis, (b) in patients with congenital syphilis, and (c) in pregnant women. High level of reaginic antibodies in these conditions may give rise to false negative reaction with undiluted serum. Repeating the test with several dilutions of the patient serum excludes this phenomenon.

Wasserman complement fixation test, Kahn's tube flocculation test, VDRL test, and rapid plasma reagin (RPR) test are the examples of STS.

**1. Wasserman complement fixation test:** This was the first serological test used in 1906 for serodiagnosis of syphilis. The test originally employed a watery extract of the lesion of a syphilitic fetus as the antigen. Subsequently, this antigen was substituted by an alcoholic extract of ox heart tissue supplemented with lecithin and cholesterol. This antigen was finally replaced by using cardiolipin antigen, a purified lipid extract of the bovine heart tissue supplemented with lecithin and cholesterol. The test, which was used as an important test in earlier days, now is no longer used.

**2. Kahn's tube flocculation test:** This was the first flocculation test used by Kahn. But the test is no more used nowadays.

**3. VDRL test:** VDRL test is a slide flocculation test used widely for the diagnosis of syphilis. The test is so named because it was developed first in the Venereal Disease Research Laboratory, USPHS, New York. This is a simple and more rapid test, which uses cardiolipin antigen with added lecithin and cholesterol. In this test, the serum is inactivated at 56°C for 30 minutes and a measured volume of serum is placed on a special cavity slide. The cardiolipin antigen after preparation is added to serum sample on a slide and is rotated on a VDRL rotator for a specified period of 4 minutes. The reaction is read under a low-power objective of microscope. In a positive test, the cardiolipin antigen reacts with reagin antibodies present in the infected serum and forms visible clumps. In a negative test, cardiolipin continues to remain as uniform crystals in the serum. The result of the test is reported as reactive, weak reactive, or nonreactive depending on the extent of the formation of the clumps. The antibody titer of the serum can also be determined by testing on serial dilutions. The reciprocal of the end point is considered as the titer (for example reactive 8 dilutions or titer 8). VDRL test can also be performed on CSF samples. Unlike serum samples, CSF samples are not heated prior to the test. The VDRL test becomes positive 4–5 weeks after exposure to *T. pallidum* and 1–2 weeks after appearance of chancre. The VDRL test is a highly sensitive test. Sensitivity of the test depends on the stage of the disease:

- The test is 60–75% sensitive in primary syphilis. The titers of antibodies, however, are relatively low.
- The test is 100% sensitive in secondary syphilis, and the serum reaginic antibody titers vary between 16 and 128 or more.
- High antibody titers may be found in patients developing gummatous lesions and neurovascular or cardiovascular complications.

The test is usually negative in tertiary or third stage of syphilis. This test is negative in early primary syphilis, latent acquired syphilis, and late congenital syphilis.

Quantitation of the sera is useful to monitor activity of the disease and is of prognostic value. The quantitative estimation of reaginic antibodies is a good prognostic marker used for treatment of syphilis. A fourfold decrease in titer following therapy suggests adequate therapy, whereas a fourfold increase in titer of reaginic antibodies following therapy suggests reinfection or relapse.

The reaginic test becomes negative 1 year after successful therapy in primary syphilis, 2 years after successful therapy in secondary or congenital syphilis, and 5 years after successful therapy in late syphilis. In some cases of neurosyphilis, this reaginic test may become negative with serum but positive with the CSF.

The main disadvantage of VDRL test is that it shows biological false positive (BFP) reactions.

**Biological false positive reactions:** BFP reactions are defined as positive reactions observed with test using cardiolipin antigen but are negative with specific test using treponema antigen. These results are not due to technical faults. They represent antibody responses to nontreponemal cardiolipin antigens found in other tissues. BFP reactions are classified as acute or chronic reactions. The reactions that become negative within 6 months are called acute reactions, while those that are found for a longer period are called chronic reaction.

- Acute BFP reactions are typically seen in (a) acute bacterial or viral infections, (b) injuries, or inflammatory conditions and (c) in early HIV infection.
- Chronic false positive reactions last for more than 6 months and are seen in (a) patients with parenteral drug use, (b) autoimmune or connective tissue diseases, such as systemic lupus erythematosus, (c) aging, and (d) hypergammaglobulinemia, (e) also seen in other infectious conditions, such as tropical eosinophilia, malaria, infectious mononucleosis, hepatitis, leprosy, and relapsing fever (Table 44-3).
- The BFP reactions can usually be ruled out by using treponema-specific test.

**The VDRL enzyme-linked immunosorbent assay (ELISA):** It is a modification of VDRL test which is being used to detect both IgM and IgG antibodies separately in the patient serum. This test is used mainly for large-scale screening of patient serum.

**4. Rapid plasma reagin (RPR) test:** RPR test is a popular test used for diagnosis of syphilis by demonstrating reaginic antibodies. The test uses VDRL antigen containing finely divided carbon particles suspended in choline chloride. The latter destroys inhibitory factors in the serum, thus avoiding the need to heat the serum before testing. Use of this antigen produces a clearer and well-defined flocculation reaction easily observed by the naked eye.

The RPR test is used for testing serum or plasma, but not for the CSF. Automated reagin test is a modification of RPR test which is used for screening of large number of serum samples.

### Treponema-specific tests

The *Treponema*-specific tests measure antibodies specific for *T. pallidum*. These tests use (a) live *T. pallidum* strains (*T. pallidum* immobilization test), (b) killed *T. pallidum* (*T. pallidum* agglutination test, *T. pallidum* immune adherence test, and fluorescent treponemal antibody test), or (c) *T. pallidum* extracts as antigens (TPHA test and EIA [enzyme immunoassay]).

**T. pallidum immobilization test:** TPI test was the first specific treponemal test, which was introduced in 1949. This test detects the treponemal antibodies in patient's serum, which immobilize motile virulent *T. pallidum*. The test is performed by incubating live *T. pallidum* strains with test serum in the presence of complement. If the serum contains treponemal antibodies, the treponemes become immobilized, which can be demonstrated under dark ground microscope. The test when introduced was the most specific serological test for diagnosis of syphilis. But because of its complexity and difficulty in maintaining live treponemal strains, this test is no longer used and is replaced by newer tests, such as TPHA and fluorescent treponemal antibody absorption (FTA-Abs) tests.

**T. pallidum agglutination test:** *T. pallidum* agglutination test uses killed *T. pallidum* suspension inactivated by formalin. The test is performed by mixing the formalin inactivated suspension of *T. pallidum* with patient's serum. If antibodies are present in the serum, it leads to agglutination of treponemal antigen, which can be demonstrated by dark ground microscopy. However, the test is no longer used, because it is non-specific and is associated with false positive reactions.

**T. pallidum immune adherence test:** In this test, a suspension of inactivated treponemes is incubated with test serum, complement, and fresh heparinized whole blood from normal individuals. If antibodies are present, treponemes are found to adhere to the erythrocytes. If antibodies are absent, the treponemes do not adhere to the erythrocytes. This test is also not used nowadays.

**Fluorescent treponemal antibody test:** FTA test is the most specific and popular test used for diagnosis of syphilis. FTA is an indirect immunofluorescence (IIF) test, which uses acetone fixed smears of *T. pallidum* on the slides. The test is performed by adding a drop of test serum to the smear on the slide followed by washing and re-incubating the smear with fluorescent labeled antihuman immunoglobulin. The slide is examined under a fluorescence microscope. Demonstration of fluorescent treponemes is suggestive of a positive FTA test.

**FTA absorption (FTA-Abs)** is a modification of FTA test, which shows high sensitivity and specificity. In this test, patient's serum is first absorbed with a sonicated extract of non-pathogenic *T. phagedenis* (*Reiter's treponeme*) to remove group-specific antibodies. The test is almost as specific as the TPI test and is considered as a standard reference test in syphilis serology.

TABLE 44-3

### Biological false positive reactions of standard tests for syphilis

#### Acute BFP reactions

- Acute bacterial or viral infections
- Injuries or inflammatory conditions
- Early HIV infection

#### Chronic false positive reactions

- Patients with parenteral drug use
- Autoimmune or connective tissue diseases, such as systemic lupus erythematosus
- Aging
- Patients with hypergammaglobulinemia
- Other infectious conditions, such as tropical eosinophilia, malaria, infectious mononucleosis, hepatitis, leprosy, and relapsing fever



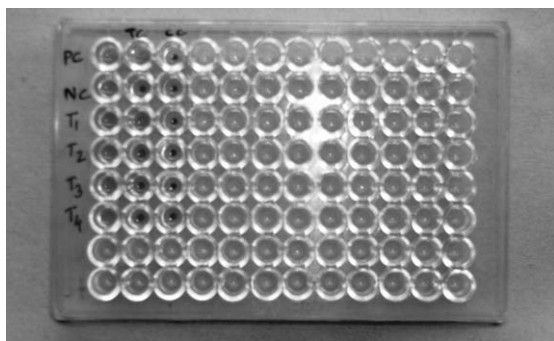

FIG. 44-3. *Treponema pallidum* hemagglutination (TPHA) test.

The FTA-Abs test is positive in 80% primary syphilis, 100% secondary syphilis, and 95% tertiary syphilis. The test is highly specific (92–99%). The test shows occasional false positive reactions in patients with rheumatoid arthritis, systemic lupus erythematosus, cirrhosis, and hypergammaglobulinemia.

The **IgM FTA-Abs test** is another modification of FTA-Abs used to detect serum IgM antibodies in congenital syphilis. This test is used to differentiate seropositivity due to passively transferred IgG maternal antibodies to the fetus from IgM antibodies found *in utero* in congenital syphilis.

**TPHA test:** TPHA test uses erythrocytes sensitized with a sonicated extract of *T. pallidum* as antigen. TPHA is now been modified to perform in microtiter plates and is referred to as microtiter hemagglutination *T. pallidum* (MHA-TP) test. This test is performed by incubating the serial dilution of the patient’s serum with erythrocytes sensitized with *T. pallidum* antigen in a microtiter plate. If antibodies are present, hemagglutination of RBCs occur (Fig. 44-3, Color Photo 50). The serum samples before testing for TPHA are reabsorbed with a diluent containing Reiter’s treponeme, rabbit testes, and sheep erythrocytes.

### Key Points

#### TPHA

- TPHA is as specific as FTA-Abs but less sensitive than FTA-Abs in primary syphilis.
- It is also equally sensitive to FTA-Abs in secondary and late syphilis.
- After successful therapy, the hemagglutinating antibodies continue to persist in the serum for a longer time; hence this test is of no prognostic value.
- The negative TPHA virtually excludes diagnosis of syphilis except during early stage of the disease and also eliminates the diagnosis of neurosyphilis.

TPHA is the most widely used treponemal test available commercially. It is simple, economical, and does not require any expensive sophisticated equipment.

**Enzyme immunoassay:** EIA uses ultrasonicated *T. pallidum* antigen coated on tubes or ferrous metal beads as solid-phase carrier for antigen. The serum antibodies are detected by an enzymatic reaction. The test is available commercially. All the treponemal tests are not completely specific for syphilis.

TABLE 44-4

### Sensitivity of serological tests for syphilis

Syphilis	VDRL	RPR	FTA-Abs	TPHA
Stage of syphilis				
Primary	+/-	-	+	-
Late primary	+	+	+	+/-
Secondary	+	+	+	+
Tertiary	+	+	+	+
Late	+	+	+	+
Latent	+/-	+/-	+	+
Treated syphilis	-	-	+	+
Congenital syphilis	+	+	+	+

VDRL, Venereal Disease Research Laboratory; RPR, rapid plasma reagin; FTA-Abs, fluorescent treponemal antibody absorption test; TPHA, *T. pallidum* hemagglutination.

They also show false positive reactions in patients with other spirochetal diseases, such as leptospirosis, relapsing fever, Lyme disease, pinta, yaws, and rat-bite fever. The sensitivity of common tests performed for the diagnosis of syphilis is summarized in Table 44-4. The test accuracy of various diagnostic methods in syphilis is presented in Table 44-5.

### Treatment

Penicillin is the drug of choice for treatment of all the stages of syphilis. A single intramuscular dose of benzathine penicillin G (50,000 units/kg, not to exceed 2.4 million units) is effective for treatment of primary, secondary, and early latent syphilis. No reports of *T. pallidum* showing resistance to penicillin have been documented. Doxycycline or tetracycline may be used for non-pregnant patients allergic to penicillin. **Jarish-Herxheimer reaction** is a noted complication observed following therapy with antibiotics. It is characterized by chills, rigors, and increase in temperature, decrease in blood pressure, and tachycardia. This reaction occurs due to production of endotoxin and other toxic products released following rapid killing and lysis of the bacteria.

### Prevention and Control

Avoidance of sexual contact with infected partners avoids transmission of infection. Use of condoms during sexual intercourse or antiseptics (such as potassium permanganate) or prophylactic use of antibiotics may minimize the risk of transmission of the disease. The use of penicillin prophylaxis, however, carries the danger that it may suppress the primary lesion without eliminating the infection.

### Nonvenereal Treponematosis

The condition includes three distinct entities, such as endemic syphilis, yaws, and pinta. These conditions are found in several parts of the world associated with poor socioeconomic condition and poor hygiene.

TABLE 44-5

Diagnostic tests for syphilis

Diagnostic test	Method	Test accuracy
Microscopy	Dark field microscopy	Less sensitive; test is reliable when examined immediately
	Direct fluorescent antibody method	Highly specific
Serology	VDRL	Sensitivity high in secondary stage and less in primary stage and late syphilis
	RPR	Sensitivity high in secondary stage and less in primary stage and late syphilis
	FTA-Abs	Highly specific and sensitive
	TPHA	Highly specific and sensitive
Molecular methods	Polymerase chain reaction	Specific; helps to distinguish between the various subspecies of <i>T. pallidum</i>
	DNA amplification	Specific

VDRL, Venereal Disease Research Laboratory; RPR, rapid plasma reagin; FTA-Abs, fluorescent treponemal antibody absorption test; TPHA, *T. pallidum* hemagglutination.

## Endemic Syphilis

Endemic syphilis is a nonvenereal treponemal infection reported from different parts of the world. The condition, also known as Bejel in the Middle East, *njovera* in Zimbabwe, *dichuchwa* in Bechuanaland, *Skerjevo* in Eastern Europe, and *siti* in Zambia, is caused by *T. pallidum* subspp. *endemicum*. The condition has also been documented from India.

The disease is transmitted from person-to-person by the use of contaminated utensils. The disease is commonly seen in young children. The initial lesions, such as primary chancre, are rarely seen. Secondary manifestations of syphilis are usually seen, which include lesions like oral papules and mucosal patches. Late manifestations of the disease include gummatous lesions of skin, bones, and nasopharynx. The laboratory diagnosis and treatment of endemic syphilis are similar to those of venereal syphilis.

## Yaws

Yaws is a nonvenereal treponemal disease caused by *T. pertenue*. The condition also known as Pian, Parangi, etc., is prevalent in the primitive tropical parts of central Africa, South America, and Southeast Asia. The condition is also documented in India from Andhra Pradesh and Madhya Pradesh.

The causative agent *T. pertenue* is morphologically and antigenically similar to *T. pallidum*. The pathogen causes yaws, which is characterized by an extragenital papule, which subsequently enlarges and breaks down to form an ulcerating granuloma. Late manifestations of the disease include destructive lesions of the skin, bone, and lymph nodes. The disease is transmitted by direct contact with infected skin lesions. Laboratory diagnosis and treatment are similar to that of venereal syphilis.

## Pinta

Pinta is a contagious disease of the skin caused by *T. carateum*. Pinta, also known as carate, mal del pinto, is endemic in Central and South America and the neighboring islands. An extragenital papule is the primary skin lesion observed in the condition. Small pruritic papules develop on surface of the skin after an incubation period of 1–3 weeks. These lesions do not ulcerate, but enlarge and persist for months to years before resolving. The condition,

if remains untreated, progresses to form disseminated recurrent and hypopigmented lesions leading to scarring and disfigurement. Pinta spreads by direct contact with infected lesions. Laboratory diagnosis and treatment are same as for syphilis.

## Nonpathogenic Treponemes

Nonpathogenic treponemes are a heterogenous group of treponemes found as commensals on the buccal and genital mucosa. They are also found on the surface of gastric and colonic epithelium in humans and animals. These include the following *Treponema* species: *Treponema denticola*, *Treponema macrodentium*, *Treponema oralis*, *Treponema socranski*, and *Treponema pectinovorum*. *T. denticola* is an oral treponeme, which is easily cultivable on artificial medium. *T. phagedenis* is also known as Reiter's and Kazan strain, and *T. refringens* is also known as Nichol's strain.

## Borrelia

Borreliae are Gram-negative bacilli, which are larger than other spirochetes. They measure 0.2–0.5  $\mu\text{m}$  in breadth and 3–30  $\mu\text{m}$  in length. They are motile and stained readily with aniline dye, such as Giemsa and Wright stain. The genus *Borrelia* consists of many species, which are found as commensals on buccal and genital mucosa. Members of the genus *Borrelia* cause two important diseases in humans:

- Epidemic or louse-borne relapsing fever is caused by *Borrelia recurrentis*, whereas endemic relapsing fever is caused by as many as 15 species of *Borrelia*. These include *Borrelia duttoni*, *Borrelia henselae*, *Borrelia parkeri*, *Borrelia tunicatai*, etc.
- *Borrelia burgdorferi* is responsible for causing Lyme disease.

## *Borrelia recurrentis*

*B. recurrentis* is the causative agent of relapsing fever, which manifests as one or more relapses of fever after the subsidence of primary paroxysm of fever.

## Properties of the Bacteria

### ► Morphology

*B. recurrentis* shows the following morphological features:

- *B. recurrentis* has an unequal spiral-shaped structure with one or both the ends pointed. It measures 8–20 μm in length and 0.2–0.4 μm in breadth.
- It possesses 15–20 endoflagella per cell and 5–10 loose uneven spiral coils. The spiral coils are coarser and more irregular than those of treponemes and leptospire.
- It is Gram negative. It can be stained by Wright and Giemsa stain for demonstration by microscope. It is actively motile in fresh blood preparation, moves in forward and backward waves, and exhibits cork-screw like motility.

### ► Culture

*Borrelia* is microaerophilic. The bacteria grow at optimum temperature of 28–30°C. They have complex nutritional requirements, hence are difficult to grow on artificial media. They can grow in chorioallantoic membrane of chick embryo. Mice or rats are highly susceptible to infection. Primary isolation of bacteria from clinical specimens can be made by intraperitoneal inoculation of specimens in these laboratory animals. After inoculation, borreliae appear early in the blood and also are found in the brain for a longer time.

## Cell Wall Components and Antigenic Structure

Antigenic variation is a unique property exhibited by *Borrelia* in humans. DNA rearrangement in linear plasmid present in *Borrelia* appears to be responsible:

- For antigenic variations shown by the bacteria and
- For causing relapse, characteristically seen in the relapsing fever caused by the bacteria.

## Pathogenesis and Immunity

*B. recurrentis* is an invasive bacterium. It enters the skin and causes disease.

### ► Virulence factors

The ability of *B. recurrentis* to undergo antigenic shift and escape from immune clearance of the host is the main virulence factor attributed to the bacteria. The antigenic shift or antigenic variations exhibited by the bacteria are primarily responsible for periodic febrile and afebrile stages observed in the relapsing fever.

### ► Pathogenesis of relapsing fever

*B. recurrentis* penetrates the skin, reaches the blood circulation and invades various organs in the body and cause the disease. After invasion of blood by bacteria, *Borrelia*-specific IgM antibodies agglutinate *Borrelia* and cause complement-mediated lysis. This leads to rapid clearing of *Borrelia* from the

blood stream. *Borrelia* present in the internal tissue alters their serotype-specific outer proteins through gene rearrangement and exhibits a new antigen.

The IgM antibodies produced against old antigens are not effective against the *Borrelia* pathogens exhibiting new antigenic variation. The host immunity responds again by producing specific antibodies against these new antigens and clears the organism from the circulation. Patients recover after a number of relapses due to development of humoral immunity.

### ► Host immunity

Host immunity is characterized by the development of specific humoral immunity against *Borrelia*. The humoral immunity contributes to recovery in a patient after a number of relapses.

## Clinical Syndromes

*B. recurrentis* causes relapsing fever—epidemic louse-borne and endemic tick-borne relapsing fever.

### ► Relapsing fever

Clinical manifestations of epidemic louse-borne and endemic tick-borne relapsing fever are essentially similar. The incubation period is usually 7 days. Two or more episodes of high fever, headache, and myalgia are the hallmarks of the disease. Splenomegaly and hepatomegaly are the associated symptoms. These symptoms correspond to the bacteremic phase of the disease when *Borrelia* is found in large numbers in patient's blood (Fig. 44-4).

The fever subsides after 3–7 days when the *Borrelia* is cleared from the circulation. After an afebrile period of 4–7 days, bacteremia occurs and fever reappears. The *Borrelia* reappears in the blood during relapse of the fever. The condition ultimately subsides after 3–10 relapses.

## Key Points

### Relapsing fever

- A single relapse is the characteristic of epidemic louse-borne disease and is usually associated with high morbidity of 4–50%.
- Repeated relapses are common in endemic tick-borne diseases and are usually associated with low mortality of less than 5%.

## Epidemiology

### ► Geographical distribution

Epidemic louse-borne relapsing fever now has disappeared with improvement in hygiene and the use of insecticides. It is an important disease only in north-eastern Africa, especially in the islands of Ethiopia and in South America. Endemic tick-borne relapsing fever has worldwide distribution and is endemic in western states of the United States.

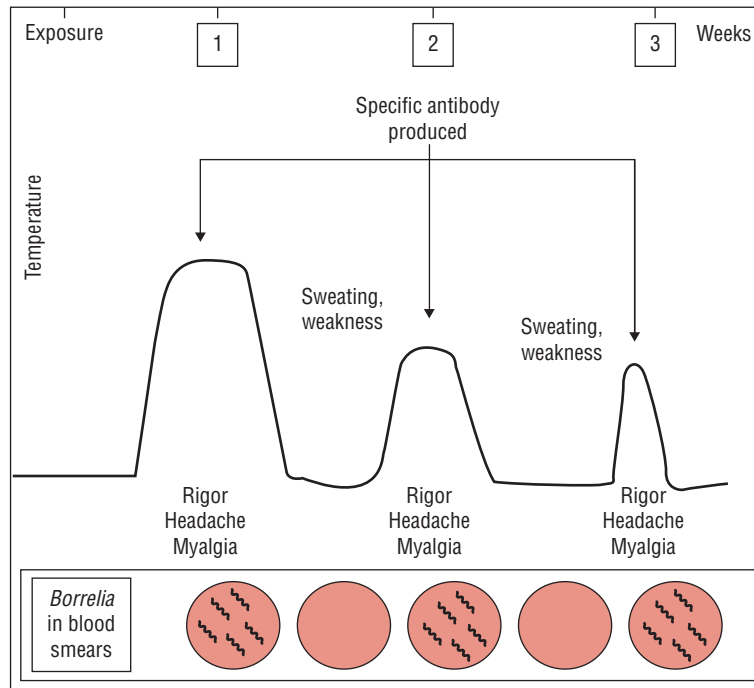

FIG. 44-4. Course of relapsing fever.

### ► Habitat

*B. recurrentis* is found in the blood stream and also in the spleen, liver, lungs, kidneys, and bone marrow of the infected patients suffering from relapsing fever.

### ► Reservoir, source, and transmission of infection

Humans are the only reservoir of epidemic relapsing fever. No extra-human reservoir is known. The infection is transmitted only from person to person. Persons suffering from relapsing fever are the source of infection. Human body louse (*Pediculus humanus corporis*) is the vector of the disease. No extrahuman reservoir is known. The *Borrelia* organisms are found only in the hemolymph of the lice. They are not excreted in saliva or excreta. Hence, the infection is transmitted by them being crushed and rubbed into the absorbed skin. They are not transmitted by bite of the lice. Endemic tick-borne relapsing fever is a zoonotic disease transmitted from animals to humans, rodents, small mammals.

Soft ticks (*Ornithodoros* species) are the main vectors of the disease. Unlike the louse-borne infection, *B. recurrentis* produces a disseminated infection in ticks. However, the vector survives from the infection and becomes reservoir of the infection by transovarian transmission. The *Borrelia* organisms are found in all parts of the body of tick; hence, they are secreted in the saliva and in excreta. Therefore, the infection is transmitted to human by the bite of the ticks. Several species of the genus *Ornithodoros* act as reservoir in different parts of the world. *Ornithodoros tholozani*, *Ornithodoros crossi*, *Ornithodoros lahorensis*, and the fowl tick, *Argas persicus* are the vectors in India. Soft ticks are primarily nocturnal feeders. They feed while the host is sleeping and remain attached for only a few minutes. Hence, the bite of the tick goes usually unnoticed.

## Laboratory Diagnosis

### ► Specimen

Blood collected from a patient during fever, but not from afebrile patient, is a useful specimen.

### ► Microscopy

A wet mount preparation of the blood examined by dark-field or phase contrast microscopy is a useful method for direct observation of *Borrelia*. The organisms are identified by their dashing movements. *Borrelia* organisms can also be demonstrated in peripheral blood smear stained with Giemsa or Wright stains. Staining is the most sensitive method for diagnosis of 70% or more patients of louse-borne relapsing fever.

### ► Culture

Cultures are not carried out routinely for isolation of *Borrelia* from clinical specimens. This is because *Borrelia* organisms have complex nutritional requirements for their growth and they grow very slowly on these media.

### ► Animal inoculation

Animal inoculation is a more sensitive method. This test is performed by inoculating a mouse intraperitoneally with 1–2 mL of blood from the infected patient. The blood is collected from the tail vein of the mice after 1–10 days. Blood is examined for the presence of *Borrelia* daily for 2 weeks.

## ► Serodiagnosis

*B. recurrentis* causing relapsing fever undergoes antigenic phase variation; hence, serological tests are not useful in the diagnosis of the condition.

## Treatment

Tetracycline or erythromycin is most effective for treatment of relapsing fever. Doxycycline is usually recommended for children and pregnant women.

## Prevention and Control

Prevention of louse infiltration and the use of insecticide are the measures that prevent louse-borne relapsing fever. Prevention of tick-borne relapsing fever consists of wearing protective clothings, use of insect repellants, and avoidance of ticks and their natural habitat. No vaccine is available for relapsing fever.

## *Borrelia vincenti*

*B. vincenti* is a motile spirochete measuring 7–18  $\mu\text{m}$  in length and 0.2–0.6  $\mu\text{m}$  in breadth. It is Gram negative and is usually stained with Giemsa and Leishman stain. *B. vincenti* is an obligate anaerobe found as normal commensal in the mouth. The bacteria under certain predisposing conditions (such as malnutrition and viral infections) produce a condition known as **Vincent's angina**. Vincent's angina is an ulcerative gingivostomatitis or oropharyngitis often associated with fusiform bacilli (*Fusobacterium fusiforme*). It is characterized by formation of ulcer on the mouth and on tonsillar areas.

Laboratory diagnosis of the condition is made by demonstration of *B. vincenti* and fusiform bacilli in stained smears of exudate from the lesion. This bacterium is grown with difficulty on enriched media anaerobically.

Penicillin and metronidazole are effective for treatment of the condition.

## *Borrelia burgdorferi*

*B. burgdorferi*, a newly identified *Borrelia* species, is the causative agent of Lyme disease. Lyme disease was first demonstrated in children in 1975, during an outbreak of arthritis in Lyme, Connecticut, in the United States. The causative agent of the fever was isolated by Burgdorfer in 1982 after whom the species *burgdorferi* is named. *B. burgdorferi* is a fastidious bacterium, which measures 4–30  $\mu\text{m}$  in length and 0.2  $\mu\text{m}$  in breadth. It is helical and Gram negative. It is a microaerophilic spirochete, which can be grown on BSK (Barbour–Stoenner–Kelly) medium at 33°C after incubation for 2 weeks or longer.

**Lyme disease** is a tick-borne disease transmitted to humans by ixodid ticks. The incubation period varies from 7 to 14 days. After bite of the tick, *B. burgdorferi* is inoculated through the

skin and then spreads locally. The local spread of the bacteria causes erythema migrans, a rash seen in approximately two thirds of the cases. This skin rash may be a confluent patch of erythema or may have central clearing. The lesion begins as a small macular papule and becomes larger over the next many weeks and forms a large area of lesion of 5–50 cm in diameter.

The patient may also complain of fever, chills, myalgias, and headache during early stage of the disease, with or without rash. Subsequently, during a period of time ranging from days to months, the bacteria spread through blood circulation and cause a disseminated disease. This disease is characterized by the presence of multiple erythema migrans, systemic complications (fever, myalgias, arthralgia, malaise, and headache) and even septic meningitis; this disease usually develops 3–10 weeks after the tick bite. The pathogenesis of these late manifestations is poorly understood. It is not known whether the live organisms cause these manifestations or these manifestations occur due to an antigenic cross-reactivity to *Borrelia* antigens.

Lyme disease has been reported from USA, Germany, Austria, Switzerland, and Scandinavian countries.

Lyme disease is a zoonotic disease. Rodents, bear, and other mammals are the natural reservoir hosts. Hard ticks (*ixodid* ticks) are the vectors of the disease. The infection is transmitted by the hard tick from mice to humans and occur by regurgitation during tick bite. Individuals exposed to hard ticks are at increased risk for Lyme disease.

Clinical diagnosis of the condition may be made by the presence of erythema migrans in the early stage of the disease. Laboratory diagnosis of the condition is primarily serological. Serodiagnosis depends on demonstration of specific antibodies in the serum, which persist for many years even after eradication of the infection. ELISA and IIF are the most common serological tests employed for the diagnosis of the disease. Western blot is used to confirm the specificity of serum positive by ELISA or IIF. Serology is positive in one-third of the patients with the early disease, in 90% of patients with early disseminated disease, and in all the patients with late disease. Microscopy is not recommended because *B. burgdorferi* is rarely seen in clinical specimens. Culture is also not used, because the bacteria are difficult to culture.

Amoxicillin, tetracycline, cefuroxime, or ceftriaxone are effective for the treatment of Lyme disease. Avoidance of exposure to ticks and use of insecticides are the useful methods for prevention of the disease.

## *Leptospira*

Leptospire are finely coiled, thin, motile, and obligate aerobes. Their flagella help them to burrow deep into infected tissues.

## Classification

The leptospire belong to the genus *Leptospira*, the family Leptospiraceae, and the order Spirochaetales. The nomenclature and taxonomy of the *Leptospira* has undergone a lot of revisions, making review of the literature often confusing.

Traditionally, the genus *Leptospira* has been grouped by serological properties and by their pathogenicity into two species: the pathogenic *Leptospira interrogans* and nonpathogenic *Leptospira biflexa*. On the basis of shared antigens, these species were further divided into serogroups, serovars, and strains. Pathogenic species, *L. interrogans* currently includes more than 250 serovars. However, the classification is not consistent with recent classification based on nucleic acid analysis. The current classification based on nucleic acid analysis divides *L. interrogans* and *L. biflexa* complex into 12 species. These species are further subdivided into serogroups, serovars, and strains on the basis of microscopic agglutination tests (MAT):

- *L. interrogans* complex includes pathogenic leptospires that cause leptospirosis.
- *L. biflexa* consists of nonpathogenic leptospires and includes more than 63 serovars. *L. biflexa* is so called because of its double curved structure (*Biflexa*: twice bend). These are mostly free-living saprophytes found in moist environmental areas but are not associated with disease in humans and animals.

### Leptospira interrogans Complex

*L. interrogans* complex includes pathogenic leptospires that cause leptospirosis. The disease, often referred to as swamp fever, mud fever, or swine herd's disease, is the most common zoonosis in the world.

### Properties of the Bacteria

#### ► Morphology

*L. interrogans* shows the following morphological features:

- *L. interrogans* are thin, delicate, coiled spirochetes measuring 6–20  $\mu\text{m}$  length and 0.1  $\mu\text{m}$  in breadth. They are actively motile by means of two periplasmic flagella, each present at opposite end of the bacteria by continually spinning on the long axes.
- They possess tightly coiled spirals and hooked ends, resembling the handle of an umbrella. They stain poorly with aniline

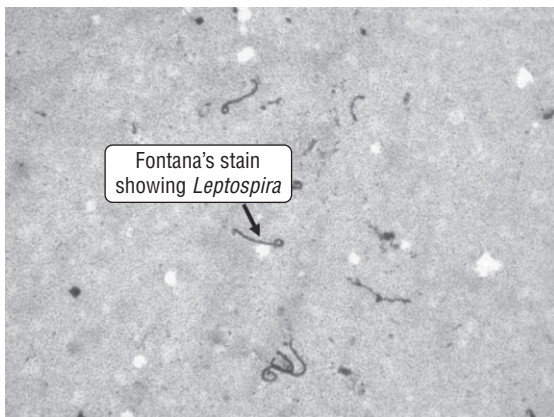

**FIG. 44-5.** Levaditi's silver impregnation staining method showing *Leptospira* ( $\times 1000$ ).

dyes but stain well with silver impregnation methods, such as Levaditi's (Fig. 44-5) and Fontana's method of staining.

#### ► Culture

*L. interrogans* are obligate aerobes. They use fatty acids and alcohols as source of carbon and energy. They grow at an optimum temperature of 25–30°C and optimum pH of 7.2–7.5.

### Key Points

- Leptospires are unique spirochetes—they can be grown in artificial medium.
- They grow on special media enriched with rabbit serum or bovine serum albumin. Korthoff's medium, Stuart's medium, and Fetcher's medium are frequently used media for culture of *Leptospira*.
- Ellinghausen, McCullough, Johnson, and Harris (EMJH) medium is a semisynthetic medium commonly used nowadays for the culture of *Leptospira*.

*Leptospira* can be grown on the chorioallantoic membrane of 10–20 days' old chick embryo. The bacteria are demonstrated in the blood of the allantoic sac 4–5 days' after inoculation.

Animal inoculation is a useful method for obtaining pure culture of *Leptospira*. The bacteria are inoculated intraperitoneally in guinea pigs followed by collection of blood from the heart 10 minutes after inoculation. Culture of the heart blood yields pure colonies of *L. interrogans*.

#### ► Other properties

**Susceptibility to physical and chemical agents:** *Leptospira* are readily killed by heating at 50°C for 10 minutes and at 60°C for 10 seconds. They are destroyed by acidity of gastric juice in 30 minutes and also by the bile. They are also readily destroyed by chlorine and commonly used antiseptics and disinfectants. They die rapidly in acidic urine, in salty or brackish water, and in nonaerated sewage.

### Cell Wall Components and Antigenic Structure

*Leptospira* organisms show a considerable degree of antigenic cross-reactivity. A genus-specific somatic antigen is present in all *Leptospira*; on the basis of which, leptospires are classified into serogroups and serotypes. This has been divided further on the basis of DNA homology into serogroups, serovars, strains, etc.

### Pathogenesis and Immunity

*L. interrogans* is an invasive bacterium.

#### ► Virulence factors

Direct invasion and multiplication in the blood and tissue is the main virulence determinant of *Leptospira*. Although direct invasion of leptospires may cause tissue damage, it is now observed

that the degree of multiorgan tissue injury does not correlate with number of leptospira in infected tissues. Therefore, it is suggested that other factors, such as the endotoxin, hemolysin, and lipase, may also contribute to pathogenicity of *Leptospira*. However, the exact virulence factors of leptospira are not known. The factors responsible for causing injury to host tissues remain unclear and appear to be a complex interaction of many factors.

### ► Pathogenesis of leptospirosis

The severity of the leptospirosis depends on (a) host immunity, (b) virulence of infecting strain, and (c) the number of infecting leptospira. After *Leptospira* enters the body through various sites, it multiplies in blood and tissues, resulting in leptospiraemia. *Leptospira* can spread to any part of the body, but affects primarily the liver and kidney. In the kidney, the bacterium causes interstitial necrosis and tubular necrosis. Subsequently, the bacterium causes tubular damage, hypovolemia due to dehydration, and altered capillary permeability causing renal failure. In the liver, it causes centrilobular necrosis and hepatocellular dysfunction leading to jaundice. *Leptospira* may also invade skeletal muscle, causing edema and focal necrosis.

### ► Host immunity

Humoral immunity plays an important role in clearance of leptospira from the circulation. Immune reactions of the host to leptospira appears to be responsible for many complications, such as meningitis and other clinical manifestations seen during the later stage of the disease.

## Clinical Syndromes

*L. interrogans* causes leptospirosis, which occurs as two recognizable clinical syndromes as anicteric leptospirosis and icteric leptospirosis. The incubation period varies from 2 to 30 days, but is usually about 10–14 days.

### ► Anicteric leptospirosis

Approximately, 90% of infections with *L. interrogans* manifest as a mild anicteric (absence of jaundice) form of the disease. These clinically inapparent infections are diagnosed only by demonstration of specific leptospira antibodies in the patient serum.

### ► Icteric leptospirosis

Approximately 10% of the patients develop icteric manifestations of the disease, otherwise known as **Weil's disease**. The disease is characterized by the development of jaundice. The disease shows two distinct phases: septicemic and immune (leptospuric). These two phases of illness are continuous and indistinguishable.

First stage is the **septicemia or leptospiremia stage**. This stage is so called because during this phase, *Leptospira* organisms are usually isolated from the blood, CSF, and most tissues by culture. This stage is characterized by a nonspecific influenza-like illness with fever and myalgias. This phase lasts for 4–7 days. The first stage is followed by 1–3 days' period of

improvement during which the temperature falls down and the patient becomes afebrile and relatively asymptomatic.

**Immune or leptospuric stage:** The second stage starts with the recurrence of fever. This stage is called immune or leptospuric stage, because circulating antibodies may be detected in serum or leptospira may be isolated from the urine, but not from blood or CSF. This stage occurs as a result of body's immune response to infection. This stage is characterized by the diseases affecting specific organs, such as meninges, liver, kidney, and eye.

Aseptic meningitis is the most important clinical manifestation. Profound jaundice, renal dysfunction, pulmonary dysfunction, hepatic necrosis, and hemorrhagic diastases are other severe manifestations.

Mortality is very high (5–10%) with Weil's syndrome. It may be as high as 22% in cases of Weil's syndrome associated with hepatorenal involvement and jaundice, and in older patients.

## Epidemiology

Leptospirosis is the most common zoonotic bacterial disease throughout the world.

### ► Geographical distribution

Leptospirosis is distributed worldwide, occurring with the greatest frequency in the tropics. This is not found in the polar regions. The condition is much more common in the Cannabian islands, the Pacific islands, Central and South America, and Southeast Asia including India.

### ► Habitat

In an infected host, leptospira are found to multiply in blood and any organ of the body but most commonly in the liver, kidney, and meninges.

### ► Reservoir, source, and transmission of infection

Leptospirosis is a zoonotic disease. Wild mammals are the primary reservoirs of infection. Leptospira infect as many as 160 mammalian species including rats, dogs, cats, cattle, pigs, raccoons, and other animals. Rodents are most important reservoirs, and rats are the most common source of infection worldwide. Leptospirosis in animals is usually a subclinical infection. Leptospira are found for a long period in kidney of these animals; as a result, animals excrete a large number of leptospira in their urine without showing any evidence of clinical disease.

Urine of the infected animals containing a large number of leptospira is the most important source of infection. Direct contact with the infected urine or urine-contaminated inanimate objects results in human infections. Animal bedding, soil, mud, and aborted tissues are examples of such inanimate objects contaminated with infected urine. The infection is transmitted to humans:

- Through intact mucous membrane or conjunctiva;
- Through minor abrasions on the surface of the skin, water-logged skin,

- Through the nasal mucosa and cribriform plate
- By inhalation of aerosolized body fluids; and
- By congenital infection (from infected mother to fetus through placenta).

The leptospire survive in soil for as many as 24 days and in fresh water for as many as 30 days. Differences between leptospire and treponemes are summarized in Table 44-6.

## Laboratory Diagnosis

### ► Specimens

Blood, urine, and CSF are used most commonly for demonstration of leptospire by microscopy or culture.

### ► Microscopy

Dark-field microscopy is employed for direct demonstration of motile leptospire in wet mount preparation of blood specimen. The method is useful for detection of leptospire in the blood specimens early in the disease, but not in the late stage. The dark-field microscopy, however, is relatively insensitive and also shows false positive results. Protein filaments from erythrocytes and other blood artifacts can be easily mistaken for *Leptospira*. Gram stain or silver impregnation staining methods are not useful to detect leptospire.

### ► Antigen detection

Direct fluorescent antibody assay is available for detection of leptospira antigen directly in blood or CSF. The method, however, is not widely used due to difficulty in availability of this test.

### ► Culture

Isolation of the organism in culture of blood, CSF, and urine establishes the specific diagnosis of leptospirosis. The positivity of the culture depends upon the time of collection of blood:

- Blood culture may be negative if collected too early or too late. Positivity is possible if the specimen is collected 4 days after the onset of symptoms.

- CSF culture is positive when specimen is collected within first 10 days, and urine culture remains positive for several weeks after the initial infection.

The specimens are cultured on Fetcher's, Stuart's, or EMJH media supplemented with neomycin and 5-fluorouracil. The culture bottles are incubated at 37°C for 2 days and thereafter in the dark, at room temperature for 2 weeks. The cultures are examined every third day for leptospire by examining in dark ground microscope. Primary isolation requires a longer period of incubation for many weeks to months.

The identification of leptospira isolates is made by agglutination tests using type-specific sera. The identification of isolates in particular serogroups, serovars, etc., is cumbersome, hence is not carried out in routine laboratories, but at reference laboratories.

### ► Animal inoculation

Leptospire can be isolated by animal inoculation. Blood is the usual specimen, which is inoculated intraperitoneally into young guinea pigs. If blood contains virulent *L. interrogans*, the guinea pig develops fever, jaundice, and dies within 8–12 days with hemorrhages into the veins and serous cavities.

### ► Serodiagnosis

Serological tests are increasingly used for diagnosis of leptospirosis. Microscopic agglutination test (MAT) is the traditional gold standard, available only at reference laboratories, for serodiagnosis of leptospirosis.

**MAT:** This test depends on the ability of the patient's serum to agglutinate live leptospire obtained by culture. The MAT test uses a battery of live leptospire serovars commonly prevalent in the area endemic for the disease. The MAT uses a battery of antigens taken from common (frequently locally endemic) leptospire serovars prepared from the leptospire strains cultured on the media. The test is performed by mixing the leptospira antigen with serial dilutions of patient's sera and examining microscopically for agglutination of leptospira antigens. A single titer exceeding 1:200 or serial dilutions

TABLE 44-6

Differences between Treponemes and Leptospire

Property	Treponemes	Leptospire
<b>Size</b>	6–14 × 0.2 μm	6–20 × 0.1 μm
<b>Spirals</b>	6–12 regular, close spirals at 1 μm interval; the ends of the spirals are pointed	Tightly coiled regular spirals with hooked ends; the interval and amplitude of spirals is 0.5 μm each
<b>Number of endoflagella</b>	3–4 at each pole	1 at each pole
<b>Motility</b>	Actively motile with flexion and extension; translatory and cork-screw like rotatory motility	Rotation around long axis forward and backward and bending and flexion
<b>Mode of infection</b>	Sexual contact, intimate cutaneous contact, blood transfusion, and transplacental	Water contaminated with rodent urine
<b>Incubation period</b>	10–90 days	7–14 days
<b>Clinical syndromes</b>	Syphilis, bejel, yaws, and pinta	Leptospirosis



exceeding 1:100 are suggestive of leptospirosis. A fourfold rise in convalescent serum is also considered positive. The MAT is highly sensitive (92%) and specific (95%).

- The MAT shows false negative reaction with serum specimens collected in immune phase of the disease and in patients treated with antibiotics.
- The MAT may show false positive reactions with serum from the cases of Lyme disease, *Legionella* infection, and syphilis.

**Other serological tests:** There is another group of serological tests, which detect serum-specific antibodies without the exact infective serovars. Nonpathogenic *L. biflexa* Patoc I strain is employed as antigen in these tests. Examples of such tests are the microscopic slide agglutination test, indirect hemagglutination assay (IHA), the leptospirosis immunoglobulin M (IgM) dipstick test, latex agglutination test, and the *Leptospira* immunoglobulin G (IgG) ELISA. IgM ELISA is of value for diagnosing new infections within 3–5 days. IHA is also rapid and simple method for diagnosis of the condition.



### Molecular Diagnosis

Polymerase chain reaction (PCR) is a sensitive and specific test for diagnosis of leptospirosis. The test is yet to be available for routine use.

Diagnostic tests for leptospirosis are summarized in Table 44-7.

## Treatment

Antimicrobial therapy is the mainstay of treatment of leptospirosis. Oral doxycycline is the drug of choice for treatment of uncomplicated *Leptospira* infection, not requiring hospitalization. Intravenous penicillin or ampicillin is recommended for hospitalized patients. Streptomycin, tetracycline, or erythromycin is indicated for patients allergic to penicillin.

**TABLE 44-7** Diagnostic tests for Leptospirosis

Diagnostic test	Method	Test accuracy
<b>Microscopy</b>	Gram stain	Organisms too thin to be detected
	Dark field examination	Insensitive, nonspecific
	Silver impregnation stain	Insensitive, nonspecific
	Direct fluorescent antibody	Insensitive, specific
<b>Culture</b>	Blood	Positive during first 10 days
	Cerebrospinal fluid	Positive during first 10 days
	Urine	Positive after first week
<b>Serology</b>	Indirect hemagglutination	Insensitive, nonspecific
	Slide agglutination	Insensitive, nonspecific
	ELISA	Insensitive, nonspecific
	Microscopic agglutination test	Sensitive, specific, serovar specific
<b>Molecular methods</b>	Direct hybridization	Insensitive, specific
	Polymerase chain reaction	Sensitive, specific

## Prevention and Control

Preventive measures include detection of cases and detection of common source of infection. Disinfection of water supplies, rodent control, and wearing of protective clothings control transmission of the disease. Leptospire infection in livestock is controlled by improved sanitation, immunization of animals, and proper veterinary care.

Recently, human vaccines are available against leptospirosis. These vaccines are recommended only for high-risk workers. These vaccines are serovar specific and usually given every year.



### CASE STUDY

A 28-year-old hair dresser complained of a painless small ulcer on the penis during the last 2 weeks. When asked, he said he had repeated sexual relation with a female sexual worker approximately many months back. On examination, the pus exudate from the smear did not reveal any *Treponema*. Serum sample was found to be positive for syphilis by the VDRL test. ELISA for HIV was negative.

- What are the specific tests used for diagnosis of the condition?
- How will you demonstrate the causative bacteria in the clinical specimens?
- What are the virulence factors of the bacteria?
- What are the antibiotics used for treatment of the condition?

# Mycoplasma and Ureaplasma

## Introduction

*Mycoplasma* belongs to class Mollicutes (*Mollis*, soft; *cutis*, skin), order Mycoplasmatales. This order contains four families—Mycoplasmataceae, Acholeplasmataceae, Spiroplasmataceae, and Anaplasmataceae; of which, most mycoplasma causing human infections belong to the family Mycoplasmataceae.

Family Acholeplasmataceae includes mostly saprophytic mycoplasmas; these mycoplasmas do not require sterols as growth factor. Family Spiroplasmataceae includes mostly mycoplasmas, which are parasites of arthropods and plants; they require sterols as their growth factor. Family Anaplasmataceae contains mycoplasmas that are strict anaerobes and are found in the intestinal tract of cattle and sheep.

## Classification

The family Mycoplasmataceae includes parasite mycoplasmas, which require cholesterol or other sterols as growth factors. It consists of two genera—*Mycoplasma* and *Ureaplasma*. At least 13 species of genera *Mycoplasma* and *Ureaplasma* are known to colonize or cause diseases in humans.

- The genus *Mycoplasma* contains the pathogens that use glucose or arginine, but do not utilize urea. The genus contains over 90 species. These species occur as commensals, parasites, and pathogens of a variety of plant insects and mammalian hosts.

*Mycoplasma pneumoniae* is the most important species known to cause infection in humans. *Mycoplasma hominis*, *Mycoplasma fermentans*, *Mycoplasma pirum*, *Mycoplasma salivarium*, *Mycoplasma orale*, and *Mycoplasma genitalium* are the other pathogens that are commonly associated with human infections.

- The genus *Ureaplasma* includes the organisms that utilize urea. Genus *Ureaplasma* consists of 5 species of which *Ureaplasma urealyticum* is the most important species isolated from infections of genital and respiratory tract in humans (Table 45-1).

Mycoplasmas are prokaryotes, but they differ from prokaryotes by having a unique cell membrane that contains sterols. Also, the mycoplasmas do not have a cell wall. *Mycoplasma* pathogens when first discovered were thought to be viruses or L form of bacteria.

TABLE 45-1

### Human infections caused by *Mycoplasma* and *Ureaplasma* species

Bacteria	Diseases
<i>Mycoplasma pneumoniae</i>	Upper respiratory tract diseases, lower respiratory tract infections, and primary atypical pneumonia
<i>Mycoplasma hominis</i>	Pelvic inflammatory disease and postpartum fever
<i>Mycoplasma fermentans</i>	Opportunistic infections in patients with HIV
<i>Mycoplasma pirum</i>	Septicemia in patients with HIV
<i>Mycoplasma salivarium</i>	Infection unknown
<i>Mycoplasma orale</i>	Infection unknown
<i>Mycoplasma genitalium</i>	Infection unknown
<i>Ureaplasma urealyticum</i>	Chorioamnionitis, prematurity, vaginitis, cervicitis, acute salpingitis, and pelvic inflammatory disease

## *Mycoplasma pneumoniae*

*M. pneumoniae* is the most important species causing upper respiratory tract disease. It is also known for causing walking pneumonia or primary atypical pneumonia.

## Properties of the Bacteria

### ► Morphology

Mycoplasmas show the following morphological features:

- Mycoplasmas are very small bacteria measuring 150–250 nm in dimension. They do not have a cell wall and typically their cell membranes contain sterols.
- Many mycoplasma can pass through 0.45 μm filter, hence were once believed to be viruses. However, they differ from viruses in the following properties:
  - They contain both ribonucleic acid (RNA) and deoxyribonucleic acid (DNA).
  - They are able to grow on cell-free media *in vitro*.
  - They show both intracellular and extracellular parasitism *in vivo*.
- *Mycoplasma* species was also considered to be L form of bacteria because they lack a cell wall. However, they differ from bacteria including L forms in the following properties:
  - They have sterols in the cell membrane.
  - They do not show any reversion to structure with cell walls.

- They do not share any DNA homology with other bacteria.
- They have genome with a low molecular weight.
- They have low guanine and cytosine contents.
- The absence of cell wall makes *Mycoplasma* resistant to penicillins, cephalosporins, vancomycin, and other antibiotics that interfere with the synthesis of the cell wall.
- *Mycoplasma* species typically show pleomorphism and occur as granular and filaments of various sizes. The filaments are slender of varying length and show true branching.
- They multiply by binary fission. However, genomic replication and cell division are often asynchronous, resulting in production of multinucleate fragments and other body forms and chains of beads.
- They do not possess flagella or pili, but some *Mycoplasma* species including *M. pneumoniae* show gliding motility on liquid-covered surfaces.
- *Mycoplasma* organisms stain poorly by Gram stain and are Gram negative. They are better stained by Giemsa and Diene stain.

### ► Culture

Mycoplasmas are aerobic and facultative anaerobes. *M. pneumoniae* is an exception, which is a strict aerobe. They grow at 37°C and at pH range of 7.3–7.8.

1. **PPLO broth:** Pleuropneumonia-like organism (PPLO) broth is a medium widely used for isolation of mycoplasma. This medium is supplemented with 20% horse serum, 10% yeast extract, and glucose. Phenol red is used as a pH indicator. The high concentration of animal serum (horse serum) is used as a source of exogenous sterols (cholesterol and other lipids). Addition of agar makes the medium solid. The medium is supplemented with penicillin, ampicillin, and polymyxin B to inhibit growth of contaminating bacteria, and amphotericin B is used to inhibit contamination with fungi.
2. **PPLO agar:** The PPLO broth is solidified by addition of agar. The mycoplasmas are typically slow growers with a generation time of 1–6 hours.

Mycoplasmas on PPLO agar produce small colonies, typically described as a fried-egg appearance, which consists of a central, opaque, granular area of growth surrounded by a flat, translucent, peripheral area. Initially, the mycoplasmas multiply within the agar to produce opaque, ball-shaped colonies that grow up to the surface of the agar and then spread around it, forming a translucent peripheral zone. Colonies may be seen with a hand lens, which is best studied after staining by Diene's method.

By this staining, the fried-egg appearance colonies of mycoplasma appear highly granular, with the center of the colonies stained dark blue and the periphery of the colonies staining light blue. The agar in the medium appears clear or a slightly violet. *Mycoplasma* other than *M. pneumoniae* becomes colorless after a period of time, because it reduces the methylene blue.

- *M. pneumoniae* unlike other *Mycoplasma* species are very slow-growing bacteria. They require 1–4 weeks to produce colonies on agar.
- *M. pneumoniae* does not produce fried-egg appearance colonies but instead produces a colony known as mulberry-shaped colonies. These colonies do not show any thin hallow unlike that of fried-egg appearance colonies.

Most *Mycoplasma* colonies produce a zone of hemolysis on blood agar. Mycoplasmas do not have the capability to synthesize cholesterol and related sterols; hence these are supplied from outside for growth of mycoplasmas. They also lack the ability to synthesize purines and pyrimidines.

### ► Biochemical reactions

Mycoplasmas show the following biochemical reactions:

1. *M. pneumoniae* and other species (*M. fermentans*, *M. genitalia*, and *M. agalactiae*) utilize glucose and other carbohydrates as the major source of energy.
2. *M. salivarium* and other species (*M. orale*, *M. hominis*, and *M. fermentans*) utilize arginine as a major source of energy.
3. Mycoplasma are chemo-organotrophs, the metabolism being mainly fermentative.

The liquid culture medium used for fermentation reaction is supplemented with glucose, arginine, and urea, and phenol red as an indicator. *Mycoplasma* species fermenting carbohydrate utilize glucose to produce lactic acid, resulting in formation of acidic pH. Arginine-utilizing *Mycoplasma* species produce ammonia, CO<sub>2</sub>, and adenosine triphosphate by metabolism of arginine. Ammonia production leads to change of the medium to alkaline.

### ► Other properties

**Susceptibility to physical and chemical agents:** Mycoplasmas are readily killed by heating at 56°C for 30 minutes. The bacteria are sensitive to antiseptic solutions, such as cycloheximide and cetrimide, which inhibit their growth. They are resistant to UV light and photodynamic action of methylene blue, hence *M. pneumoniae* can grow in presence of 0.002% of methylene blue in agar, while many other *Mycoplasma* species are inhibited at this concentration.

## Cell Wall Components and Antigenic Structure

Membrane glycolipids and proteins are the major antigenic determinants of the mycoplasmas. Membrane glycolipid antigens show cross-reaction with human tissues and other bacteria. These antigens are identified by complement fixation tests. Glycolipids with similar antigenic structure have been demonstrated in neurons in human brain. The antibodies against *M. pneumoniae* glycolipid may cross-react with brain cell, therefore, causing damage to neuronal cells. This cell damage possibly is

responsible for neurological manifestations of *M. pneumoniae* infection.

*M. pneumoniae* possesses two major surface proteins including the adhesion protein P1, which is responsible for attachment of bacteria to cell structures. These protein antigens are identified by enzyme-linked immunosorbent assay (ELISA). The P1 protein induces production of antibodies, which not only react with P1 protein but also react with antigenic determinants of RBCs, leading to lysis of erythrocytes in autoimmune disease process.

## Pathogenesis and Immunity

Mycoplasmas are primarily extracellular pathogens that adhere to surface of ciliated and nonciliated epithelial cells.

### ► Virulence factors

The adhesion protein called P1 is the key virulence factor of the *Mycoplasma*. The bacteria usually do not cause invasion of the blood to produce systemic manifestation of the disease.

**P1 antigen:** P1 antigen is a membrane-associated protein, which helps in adhesion of mycoplasmas to epithelial cells. This protein or adhesin combines specifically with sialated glycoprotein receptors present at the base of the cilia on epithelial surface. This same receptor is also present on the surface of the erythrocytes. The antibodies against P1 antigen can also act as an autoantibody against RBCs causing their agglutination.

### ► Pathogenesis of Mycoplasma infections

Following attachment, *Mycoplasma* cause direct damage to the epithelial cells in which first cilia and then ciliated epithelial cells are destroyed. Loss of the cells interferes with normal functioning of the upper respiratory tract. This results in the lower respiratory tract to become infected with microbes and mechanically irritated. The mechanical irritation causes persistent cough typically seen in patients with respiratory infection caused by *M. pneumoniae*.

*M. pneumoniae* behaves as a super antigen. This causes migration of inflammatory cells to the site of infection and produces cytokines, such as tumor necrosis factor-alpha, interleukin-1, and interleukin-6. These cytokines help in clearing of the bacteria and of the disease. The bacteria usually do not cause invasion of the blood to produce systemic manifestation of the disease.

*Mycoplasma* rarely penetrates the submucosa except in rare cases of immunosuppression or following instrumentation. In these conditions, they may invade the blood stream and cause infection in different organs of the body.

### ► Host immunity

*M. pneumoniae* infection does not induce any protective immunity. Individuals suffering from *M. pneumoniae* infection are susceptible to reinfection by the bacteria. The P1 antigen induces production of antibodies. These antibodies are found in nearly 50% of patients infected with *M. pneumoniae*. The antibody against P1 antigen is an autoantibody that cross-reacts with antigen I of RBCs and is not protective.

## Clinical Syndromes

*M. pneumoniae* primarily causes respiratory infections in humans.

### ► Respiratory infections

Majority of the respiratory infections are mild and self-limiting. *M. pneumoniae* causes (a) upper respiratory tract infections, (b) lower respiratory tract infections, and (c) primary atypical pneumonia.

**Upper respiratory tract infections:** *M. pneumoniae* typically causes mild upper respiratory tract infections. The condition is characterized by low-grade fever, malaise, and headache. Nonproductive cough is a typical manifestation, which appears 2–3 weeks after exposure. The cough is initially nonproductive but may later produce small to moderated quantities of sputum, which may become mucopurulent and even blood tinged in more severe cases.

**Lower respiratory tract infections:** These include tracheobronchitis and bronchopneumonia. The condition is characterized by primary infection of bronchi with infiltration of bronchial epithelial cells by lymphocytes and plasma cells.

**Primary atypical pneumonia:** The condition is also known as *walking pneumonia*. Incubation period varies from 2 to 3 weeks. Patients suffering from atypical pneumonia usually do not appear ill. Hence, the illness is often referred to as walking pneumonia. The pharynx is affected, becomes edematous but without any cervical adenopathy. The condition is associated with presence of patchy bronchopneumonia seen on the chest X ray. Disparity between physical findings and radiological evidence of chest is the hallmark of infection. The infection is usually self-limiting. In 5–20% of patients, pleural effusion may occur.

### ► Extrapulmonary infections

Extrapulmonary manifestations are not rare. Cardiac abnormalities, such as myocarditis and pericarditis are the most frequently reported extrapulmonary manifestations. Other manifestations include neurological abnormalities, otitis media, and erythema multiforme (Stevens–Johnson syndrome). *M. pneumoniae* infections tend to cause much more severe disease in:

- children suffering from immunosuppressive disease;
- individuals with sickle cell anemia, functional asplenia and
- children with Down syndrome.

Subclinical infection may occur in 20% of adults (Fig. 45-1).

## Epidemiology

### ► Geographical distribution

*M. pneumoniae* infection is distributed worldwide. The organism is responsible for up to 20% of community-acquired pneumonia, which requires hospitalization. *M. pneumoniae* infection occurs both in epidemic and in endemic forms. The condition

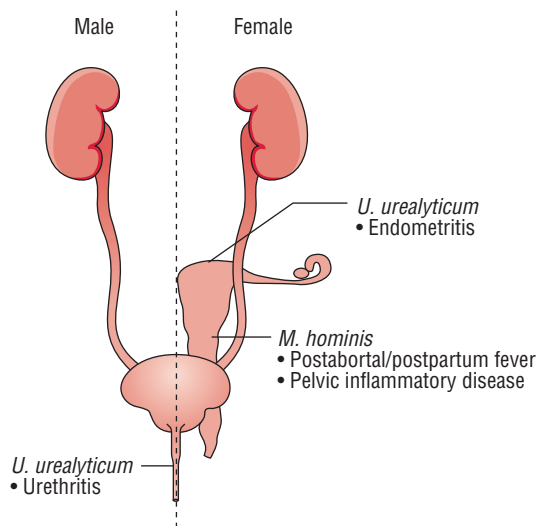

FIG. 45-1. Infections caused by *Mycoplasma* and *Ureaplasma* species.

is widely documented in the European countries and in the United States. The exact information on *M. pneumoniae* infection is not available from the developing countries. However, the results of few seroprevalence studies indicate that the condition may be endemic in many of the developing countries.

### ► Habitat

*M. pneumoniae* is a strict human pathogen. The bacteria inhabit the upper respiratory tract in an infected host. They are usually present in the mucosa, residing extracellularly on the upper respiratory tract.

### ► Reservoir, host, and transmission of infection

Humans are the usual host of *M. pneumoniae* and thus significant reservoir of infection. Patients with active infection are more likely to transmit *M. pneumoniae* infection. *M. pneumoniae* is most commonly transmitted by close contact through nasal secretions. The infection is transmitted by inhalation of aerosolized droplets. Person-to-person transmission usually occurs among college students and military recruits who live together in close proximity. *M. pneumoniae* is usually associated with pneumonia, and highest rate of infection is found in children between 9 and 10 years, and also in young adults. Infection is common among school-going children.

In recent years, the infection is also being increasingly documented in people older than 65 years. In this old population, *M. pneumoniae* is responsible for causing nearly 15% of community-acquired pneumonia and is second pathogen next only to *Streptococcus pneumoniae* as a cause of pneumonia.

### Key Points

- *M. pneumoniae* infection is uncommon in infants.
- Individuals with sickle cell disease and immunosuppression are at increased risk for systemic infection caused by *M. pneumoniae* and may develop pleural effusion and profound respiratory distress.

## Laboratory Diagnosis

Initial treatment of *M. pneumoniae* infection is based on clinical diagnosis of the condition. The definite diagnosis of the condition usually takes 3–4 weeks. Hence, treatment is started without waiting for the result of laboratory tests.

### ► Specimens

Respiratory specimens include throat washings, bronchial washings, and expectorated sputum. Tracheal washings are more useful than sputum specimens, because most patients with respiratory tract infections do not produce any sputum as they have a dry and nonproductive cough. The specimens are collected and transported to the laboratory immediately.

- If delay is anticipated, they are usually inoculated in suitable transport media, such as SP4 transport medium to prevent desiccation.
- The specimens can be stored at  $-70^{\circ}\text{C}$  if these cannot be sent immediately to the laboratory after collection.

### ► Microscopy

Microscopy is of no value in diagnosis of *M. pneumoniae* infections. Mycoplasmas are stained poorly, because they lack cell wall.

### ► Direct antigen detection

Antigen capture immunoassay has been used for direct detection of *M. pneumoniae* in sputum specimen with high sensitivity and specificity. Direct immunofluorescence, counter-current immunoelectrophoresis, and immunoblotting with monoclonal antibodies are the tests used for detection of antigen in clinical specimens.

### ► Culture

Bacterial culture is of little practical value because of its fastidious growth requirements and need for 3–4 weeks for culture. Isolation of *M. pneumoniae* from clinical specimens by culture confirms the diagnosis of *M. pneumoniae* respiratory illness. The specimens are inoculated into mycoplasma medium, such as PPLO agar supplemented with serum (source for sterols), glucose, pH indicator, yeast extract (source for nucleic acid precursor), and antibiotics and antifungal agents (to inhibit bacteria and fungi). On this medium, *M. pneumoniae* grows very slowly and colonies are demonstrated at  $37^{\circ}\text{C}$ . The growth is facilitated by incubation in the presence of 95%  $\text{N}_2$  and 5% of  $\text{CO}_2$ . The bacteria produce small colonies with homogenous appearance, typically described as *mulberry-shape colonies*.

### ► Identification of bacteria

The identifying features of *M. pneumoniae* colonies are summarized in Box 45-1. They are identified by the following tests.

**Color change:** The colonies are identified by noting a color change from red to yellow of phenol red due to fermentation of glucose resulting in the production of acid, which makes pH of the media acidic.

**Diene test:** In this method, the Diene stain (diluted 1:10 with distilled water) is added directly to the plate containing suspected colonies of *Mycoplasma*. The plate is then immediately rinsed with distilled water to remove the stain. This is followed by decolorizing the medium by adding 1 mL of 95% ethanol and keeping it for 1 minute. The plate is rewashed with distilled water and is allowed to dry. After drying, the colonies are observed under low power of the microscope.

By Diene staining, the fried-egg appearance colonies of *Mycoplasma* appear highly granular, with the center of the colonies stained dark blue and the periphery of the colonies staining light blue. The agar in the medium appears clear or slightly violet. *Mycoplasma* other than *M. pneumoniae* becomes colourless after a period of time because it reduces the methylene blue. The colonies identified are confirmed by inhibition of their growth with specific *M. pneumoniae* antisera.

**Hemadsorption test:** The test is performed by flooding *M. pneumoniae* colonies grown on surface of agar with 2 mL of 0.2–0.4% suspension of guinea pig erythrocytes in *Mycoplasma* growth medium. The plate is incubated at 35°C for 35 minutes followed by washing with 3 mL of *Mycoplasma* growth medium by gently rotating the plate. The washing fluid is gently removed by aspiration with a pipette. *M. pneumoniae* colonies adsorb guinea pig erythrocytes, which is facilitated at 37°C. *M. pneumoniae* colonies adsorbing erythrocytes on their surface are demonstrated under the microscope. The colonies are observed under 40× magnification.

**Tetrazolium reduction test:** The test is based on the principle that *M. pneumoniae* has the ability to reduce triphenyl tetrazolium, a colorless compound, to formazan, a red-colored compound. This test is performed by flooding the colonies of *M. pneumoniae* on agar with a solution of 2-*p*-iodophenyl-3-nitrophenyl-5-phenyltetrazolium chloride and incubating it at 35°C for an hour. In a positive test, *M. pneumoniae* colonies appear reddish after 1 hour and may appear purple to black after 3–4 hours of incubation.

## ▸ Serodiagnosis

Serodiagnosis is based on demonstration of specific antibodies in serum using *Mycoplasma* antigens. *M. pneumoniae* glycolipid

antigen extracted by chloroform and methanol is also widely used for serodiagnosis of atypical pneumonia. Complement fixation test and ELISA are the tests frequently used.

**Complement fixation test:** A fourfold rise in complement-fixing antibody titer or a single titer of 1:64 or more is suggestive of recent infection. The complement-fixing antibodies appear after 7–10 days of infection and reach the peak after 4–6 weeks of infection. The complement-fixing antibodies are demonstrated in approximately 80% of the cases.

**Enzyme-linked immunosorbent assay:** IgM ELISA is most frequently used test. IgM ELISA is used to detect specific IgM antibodies in a single serum specimen. This test has a specificity of 99% and sensitivity of 97%. Recently, a quantitative, rapid, single-specimen, membrane-based ELISA has been evaluated as a rapid diagnostic method for demonstration of either IgM or IgG antibodies. The results for this test can be obtained within 30 minutes of performing the test.

**Nonspecific serological tests:** These tests are called nonspecific because they do not use specific *Mycoplasma* antigen; instead they use cross-reacting and nonspecific antigens. These tests include *Streptococcus* MG agglutination test and cold agglutination test.

- ***Streptococcus* MG agglutination test:** In this test, a heat-killed suspension of *Streptococcus* MG is used as antigen. The antigen is mixed with serial dilution of patient's unheated serum. The agglutination is observed after overnight incubation at 37°C. An antibody titer of 1:20 or more is suggestive of *M. pneumoniae* infection.
- **Cold agglutination test:** In this test, human O group erythrocytes are used as antigen. This is based on the principle that autoantibodies that agglutinate human O group cells at low temperatures appear in most of the cases of atypical pneumonia. The test is performed by collecting patient's blood, which should never be refrigerated before separation of serum because agglutinins are readily absorbed by homologous RBCs at low temperatures. The patient's serum is mixed with equal volume of 0.2% washed suspension of human O erythrocytes. The suspension is incubated at 4°C overnight and observed for clumping. The clumping is dissociated at 37°C. The titer of 1:32 or more is suggestive of *M. pneumoniae* infection.

The cold agglutinins usually appear in more than 50% of the cases by the second week of infection and reach a peak at 4–5 weeks. The antibody titer thereafter declines rapidly, and test becomes negative in about 5 months. A fourfold rise in cold agglutinin titer of the paired serum and convalescent sera, or a single titer of 1:32 is suggestive of *M. pneumoniae* infection. The noted disadvantage of this test is that this is a nonspecific test, because the cold agglutinins are also demonstrated in sera of other diseases, such as rubella, infectious mononucleosis, adenovirus infections, psittacosis, tropical eosinophilia, trypanosomiasis, cirrhosis of liver, and hemolytic anemia.

### Box 45-1

#### Identifying features of *Mycoplasma*

1. Very small bacteria; poorly stained with Gram stain but stain well with Diene stain.
2. A color change from red to yellow of phenol red.
3. Colonies stained directly by applying Diene stain.
4. Colonies positive for hemadsorption test.
5. Colonies positive for tetrazolium reduction test.
6. The colonies identified are confirmed by inhibition of their growth with specific *M. pneumoniae* antisera.
7. On agar, mycoplasmas produce colonies having a "fried egg" appearance with an opaque central zone of growth within the agar and a translucent peripheral zone on the surface.



## Molecular Diagnosis

Recently, a seminested polymerase chain reaction (PCR) assay using 60S ribosomal DNA has been developed for demonstration of P1 adhesin in protein for diagnosis of *M. pneumoniae* infection. These tests are of high sensitivity and specificity. They have added advantage of detecting *M. pneumoniae* infections at an early stage. Disadvantage of the test is that it is expensive and is available only in few laboratories.

## Treatment

Therapy with antibiotics is usually not necessary for treatment of upper respiratory tract infection caused by *M. pneumoniae*. However, treatment with antibiotics may be helpful for management of *Mycoplasma pneumoniae*, because it reduces duration of illness and also reduces the number of *Mycoplasma* in clinical specimen. It also reduces the symptoms, enhances resolution of pneumonia, and facilitates recovery from the disease. Pneumonia is usually a self-limiting disease and is not life-threatening in most patients.

*M. pneumoniae* remains susceptible to tetracyclines and erythromycin, because these antibiotics act on the mycoplasmas by inhibiting synthesis of protein. Tetracycline has the additional advantage of also being active against most other mycoplasmas and chlamydiae, the common causes of nongonococcal urethritis.

*Mycoplasma* organisms are resistant to penicillins and cephalosporins, because these antibiotics act on the cell wall, which is lacking in mycoplasmas.

## Prevention and Control

Isolation of the patients infected with *M. pneumoniae* is the best way to prevent the spread of the disease. Antibiotic prophylaxis with tetracyclines or erythromycin is also useful. No vaccine is available against *Mycoplasma* infections.

## Genital *Mycoplasma* Species

*M. hominis* and *Mycoplasma genitalis* are the genital *Mycoplasma* species, which inhabit the mucosa of the urogenital tract.

### *Mycoplasma hominis*

*M. hominis* is a facultative anaerobe and is relatively a fast-growing *Mycoplasma*, which grows within 1–4 days. The bacteria metabolize arginine but do not utilize glucose. *M. hominis* typically produces large fried-egg appearance colonies on *Mycoplasma* medium. Inhibition of the growth of the bacteria with specific antisera to *M. hominis* is used to differentiate it from other genital mycoplasmas. The clinical manifestations by genital mycoplasmas vary depending on the type of infection:

- *M. hominis* is associated with infection of genitourinary tract and reproductive disease. *M. hominis* causes genital infection, which may result in diverse manifestation, such as salpingitis, pelvic abscess, puerperal infection, septic abortion.
- It also causes nongenital infections, such as septic arthritis, peritonitis, septic thrombophlebitis, and brain abscess.
- It may also cause primary atypical pneumonia and meningitis in newborns.

The incidence of colonization by genital mycoplasmas increases after puberty and is related to the sexual activity. *M. hominis* colonizes in approximately 15% of sexually active men and women, while *Ureaplasma* colonizes 45–70% of sexually active women.

*M. hominis* organisms unlike other mycoplasmas are resistant to erythromycin and occasionally to tetracyclines. Clindamycin is useful to treat infections caused by such resistant strains of *M. hominis*.

### *Mycoplasma genitalis*

*M. genitalis* has also been implicated as a cause of nongonococcal urethritis and pelvic inflammatory disease (PID). *M. genitalis* is primarily a pathogen of the gastrointestinal tract, which can cause occasional infection in the genitourinary and respiratory tract. It is a very difficult organism to be isolated by culture. Their isolation may require more than 2–4 months of incubation.

These genital *Mycoplasma* species have been isolated more frequently from African American than from white men and women. Colonization of infants by *Mycoplasma* species usually occurs during passage of the baby through the birth canal. Colonization with these genital mycoplasmas occurs only up to 2 years.

Since genital mycoplasmas have been transmitted sexually, avoidance of sexual activity or the use of proper safety procedures prevents the disease caused by these genital mycoplasmas.

### *Ureaplasma urealyticum*

*U. urealyticum* is a genital pathogen, which is associated with the urogenital tract of humans and animals. It is one of the most important causes of nongonococcal urethritis. The bacteria require supplementation with urea for their growth. *Mycoplasma* medium supplemented with urea, which is highly buffered to prevent alkalinity of the medium, is useful for growth of *U. urealyticum*. *U. urealyticum* typically hydrolyzes urea as essential growth factor for the bacterium.

The bacteria like those of mycoplasmas produce very minute colonies measuring 15–50  $\mu\text{m}$  in size. Hence, they were earlier called T strain or T strain *Mycoplasma*. This human T strain *Mycoplasma* is now redesignated as *U. urealyticum*.

*U. urealyticum* is a sexually transmitted pathogen and causes chorioamnionitis, prematurity, vaginitis, cervicitis, acute salpingitis, and pelvic inflammatory disease in women. *Ureaplasma* organisms are most frequently isolated from infants, particularly girls. The bacteria also cause urethritis, proctitis, balanoposthitis, and Reiter's syndrome in men.

## Atypical Pneumonia

Atypical pneumonia is a term used to distinguish from typical pneumonia caused by *Streptococcus pneumoniae*. Earlier any patient with sudden onset of fever, chills, pleuritic pain, and expectoration of blood-tinged sputum was believed to present with typical pneumonia caused by *S. pneumoniae*. The patients not showing these characteristic manifestations were referred to as having atypical pneumonia. *M. pneumoniae*, *Chlamydia*

*pneumoniae*, and *Legionella pneumophila* are three important agents responsible for atypical pneumonia. In this condition, these pathogens are usually not isolated from sputum by routine culture methods.

Beta-lactam antibiotics are usually ineffective against *Mycoplasma* because of the absence of cell wall, and these antibiotics usually act by inhibiting synthesis of cell wall. Penicillin and cephalosporins are ineffective against all these pathogens because they do not show intracellular penetration in these pathogens.



### CASE STUDY

A 3-year-old boy attended the Medicine OPD with symptoms of sudden onset of fever, chills, pleuritic pain, and expectoration of blood-tinged sputum. Routine bacteriological culture was negative. Serum for cold agglutination test was positive.

- Diagnose the disease.
- What are the other laboratory tests used for the diagnosis of the condition?
- List other pathogens causing the disease.
- What are other genital mycoplasmas known to cause human infections?



# Actinomycetes

## Introduction

Actinomycetes are Gram-positive, catalase-positive, nonmotile bacilli. They are considered to be transitional forms between bacteria and fungi. Like bacteria they possess cell wall, containing muramic acid. They also possess prokaryotic nuclei and are susceptible to antibiotics. But like fungi, they form delicate filaments called *hyphae* similar to the hyphal form in fungi. These hyphal forms are seen in bacteria isolated by culture and are also seen in clinical specimens.

The actinomycetes include a wide range of bacteria, which are found in soil and putrefied vegetables. They are also found in humans and animals. The actinomycetes include anaerobic or facultative anaerobic bacteria belonging to the genus *Actinomyces*. Furthermore, depending on the presence or absence of mycolic acids in the cell wall, aerobic actinomycetes can be broadly classified into two groups as follows:

- 1. Actinomycetes with mycolic acids:** This group includes members of three families: Corynebacteriaceae, Mycobacteriaceae, and Nocardiaceae. The family Nocardiaceae consists of four genera: *Nocardia*, *Rhodococcus*, *Tsukamurella*, and *Gordonia*. Members of all these genera stain poorly with Gram stain and are partially acid fast.
- 2. Actinomycetes without mycolic acid:** This group includes many opportunistic pathogens, such as *Actinomadura*, *Nocardiosis*, *Streptomyces*, *Dermatophilus*, *Oerskovia*, *Rothia*, *Tropheryma*, and thermophilic actinomycetes—*Saccharopolyspora*, *Saccharomonospora*, and *Thermoactinomyces*.

Human infections caused by actinomycetes are summarized in Table 46-1.

## Actinomyces

*Actinomyces israeli* is the most common *Actinomyces* causing human infection. Other species are *Actinomyces gerencsonei*, *Actinomyces turicensis*, *Actinomyces radingae*, *Actinomyces europaeus*, *Actinomyces naeslundii*, *Actinomyces odontolyticus*, *Actinomyces viscosus*, *Actinomyces meyeri*, and *Propionibacterium propionicum*.

## Properties of the Bacteria

### ► Morphology

*Actinomyces* show the following features:

- *Actinomyces* organisms are Gram-positive, nonmotile, non-spore-forming, and non-acid-fast bacilli.
- They measure 0.5–1  $\mu\text{m}$  in diameter.
- They often grow in filaments that separate into bacillary and coccoid filaments.

### ► Culture

*Actinomyces* organisms are facultative anaerobes. They grow better under anaerobic or microaerophilic conditions at an optimum temperature of 35–37°C. Presence of 5–10% CO<sub>2</sub> facilitates the growth. *Actinomyces* species grow slowly; they need a longer incubation period of 3–4 days. *A. israeli* may require even 7–14 days for growth.

**1. Brain heart infusion agar:** Brain heart infusion (BHI) agar or heart infusion agar supplemented with 5% defibrinated rabbit, sheep, or horse blood is the enriched medium used frequently for *Actinomyces*. On these media, in an anaerobic to

TABLE 46-1

Human infections caused by Actinomycetes

Bacteria	Diseases
<i>Actinomyces</i> species	Cervicofacial actinomycosis, thoracic actinomycosis, and actinomycosis of the abdomen and pelvis
<i>Nocardia</i> species	Primary cutaneous nocardiosis, bronchopulmonary infection, and secondary central nervous system infection
<i>Rhodococcus</i> species	Pulmonary infections and opportunistic infections (traumatic endophthalmitis, peritonitis in patients undergoing dialysis, and post-traumatic skin infection)
<i>Gordonia</i> species	Opportunistic infections
<i>Tsukamurella</i> species	Opportunistic infections
<i>Tropheryma whippelii</i>	Whipple's disease
<i>Dermatophilus</i> species	Exudative dermatitis
<i>Oerskovia</i> species	Opportunistic infections (catheter-associated bacteremia, traumatic endophthalmitis, CNS shunt infections, etc.)

microaerophilic conditions, the bacteria form colonies with a characteristic molar-tooth appearance.

**2. Liquid media:** Heart infusion blood and thioglycollate blood supplemented with 0.1–0.2% sterile rabbit serum are the examples of liquid media used for culture of *Actinomyces* species.

## Pathogenesis and Immunity

*Actinomyces* species are present as normal flora of the oral cavity and also in the lower gastrointestinal tract and female genital tract of human hosts.

### Key Points

- The actinomyces by themselves are not virulent, but they require the presence of devitalized or dead tissue and a break in the continuity of the mucosal membranes to facilitate their invasion into deeper tissues and cause infection.
- Establishment of human infection by *Actinomyces* always requires the presence of companion bacteria.
- These companion bacteria help in initiation of infection by producing a toxin or enzyme or by inhibiting host immunity.

These companion bacteria are believed to act as copathogens that enhance the virulence of *Actinomyces*. These companion bacteria include *Bifidobacterium dentium*, *Actinobacillus actinomycetemcomitans*, *Eikenella corrodens*, *Haemophilus aphrophilus*, *Bacteroides*, *Fusobacterium*, staphylococci, and anaerobic streptococci.

Once the infection is established by *Actinomyces*, the immune system of the infected human host stimulates an intense inflammatory response in the form of a suppurative granulomatous and fibrotic reaction. Infection by *Actinomyces* typically spreads contiguously and invades surrounding tissues and organs. Finally, the infection results in the production of draining sinus tracts, which contain lot of damaged tissue. Bacteria from this site may disseminate through blood circulation to distant organs.

## Clinical Syndromes

*Actinomyces* causes actinomycosis.

### ▶ Actinomycosis

Actinomycosis is a subacute and chronic bacterial infection characterized by contiguous spread and suppurative and granulomatous inflammation. The condition is associated with the formation of multiple abscesses and development of sinus tracts discharging white to yellowish granules, known as sulphur granules. Actinomycosis may manifest as (a) cervicofacial actinomycosis, (b) thoracic actinomycosis, and (c) actinomycosis of the abdomen and pelvis.

**Cervicofacial actinomycosis:** It is the most common manifestation in humans comprising about two-thirds of reported cases. The infection occurs in the cervicofacial region, which typically occurs following oral surgery in patients with poor oral hygiene. Initially, the condition manifests as a swelling of

the soft tissue of the perimandibular area and subsequently, during the course of the infection, the disease spreads directly into the adjacent tissues and leads to formation of fistulas. These fistulas or sinus tracts discharge purulent material containing yellow granules, known as sulfur granules. If left untreated, this condition may spread to the blood and eventually to the brain and to the orbit.

**Thoracic actinomycosis:** This condition is responsible for 15–20% of cases of actinomycosis. It is caused by aspiration of oropharyngeal secretions containing *Actinomyces* and occasionally during perforation of the esophagus. The condition also occurs by direct spread from an actinomycotic lesion of the nape of the neck or the abdomen, or through blood circulation from other distant sites. The condition commonly presents as a pulmonary infiltrate or mass involving the lung. The condition, if left untreated, can spread outwardly through the pleura, pericardium, and chest wall, ultimately leading to the formation of multiple sinuses that discharge sulfur granules.

**Actinomycosis of the abdomen and pelvis:** This condition accounts nearly 10–20% of reported cases. The ileocecal region is the most common site involved in the condition. The condition typically presents as a slowly growing tumor. The infection subsequently spreads and involves abdominal organs including the abdominal wall, leading to the formation of draining sinuses. Actinomycosis of pelvis is commonly associated with prolonged (for many years) use of intrauterine contraceptive devices. The infection spreads directly from uterus to pelvis.

## Epidemiology

Actinomycosis is distributed worldwide. The condition is more common in rural areas and in farm workers. The condition is seen more commonly in individuals with poor dental hygiene and in the people with low socioeconomic conditions. Men are affected more commonly than women (male to female ratio is 4:3) with the exception of pelvic actinomycosis. Majority of the cases are reported in young and middle-aged patients.

## Laboratory Diagnosis

Laboratory diagnosis is made by direct detection of *Actinomyces* in specimens by microscopy and by isolation of organism by culture.

### ▶ Specimens

The specimens include sputum, bronchial secretions and discharges, and infected tissues. All these specimens may contain large number of sulfur granules. The sulfur granules are also present on the dressings removed from a draining sinus tract. It is essential to transport these specimens immediately to the laboratory for processing, preferably under anaerobic conditions.

### ▶ Microscopy

Sulfur granules are white to yellow and vary in size from minute specs to large granules. These granules are separated from pus and

other specimens and are collected directly from draining sinuses. These are crushed between two slides and are stained by Gram or Ziehl–Neelsen staining method, using 1% sulfuric acid for decolorization. The stained smears on microscopic examination show Gram-positive hyphal fragments surrounded by peripheral zone of swollen, radiating, club-shaped structures presenting a sun-ray appearance. These club-shaped structures are Gram positive, acid fast, and are believed to be antigen complexes.

### ► Culture

Sulfur granules or pus-containing *Actinomyces* are immediately cultured under anaerobic conditions at 35–37°C for up to 14 days. The specimens are inoculated on blood agar, BHI agar, and into thioglycollate broth and incubated anaerobically at 37°C. *A. israeli* produces large (0–5 mm in diameter), white, smooth, entire or lobulated colonies resembling molar tooth after 10 days of anaerobic incubation.

### ► Identification of bacteria

Actinomycetes colonies are identified by microscopy, biochemical reactions, direct fluorescent antibody test, and gel immunodiffusion test (Box 46-1). The latter two tests are very useful to differentiate *A. israeli* from other actinomycotic species and filamentous anaerobes that produce similar type of granules in the tissues.



### Molecular Diagnosis

DNA probes and PCR (polymerase chain reaction) have been evaluated and used with high sensitivity and specificity for accurate identification of *Actinomyces* species in clinical specimens.

### Treatment

High-dose penicillins or tetracyclines given over a prolonged period are the mainstay of therapy for actinomycosis. Metronidazole, cotrimoxazole, and sulfamethoxazole, and penicillinase-resistant penicillins, such as methicillin, oxacillin, and cloxacillin do not have activity against *Actinomyces* species. Surgical therapy is included for more extensive and complicated cases of actinomycosis.

#### Box 46-1

### Identifying features of *Actinomyces* species

1. Gram-positive bacilli.
2. Nonmotile, nonsporing, and non-acid-fast bacilli.
3. Produce molar-tooth shaped colonies.
4. Species identification is made by direct fluorescent antibody test and gel immunodiffusion test.
5. Facultative anaerobes grow best under anaerobic or micro-aerophilic conditions with the addition of 5–10% CO<sub>2</sub>.

### Prevention and Control

Good dental hygiene and oral hygiene are important in prevention of the disease.

### *Nocardia*

*Nocardia* are aerobic actinomycetes that are ubiquitous in the soil, decaying organic matter, and water.

### Classification

The genus *Nocardia* has been classified into 10 species on the basis of phylogenetic analysis of 16S rRNA. These species can be differentiated on the basis of biochemical reactions. *Nocardia asteroides*, *Nocardia brasiliensis*, *Nocardia otitidiscaviarum*, and *Nocardia farcinica* are the species frequently associated with human infections. *Nocardia* species also cause infection in animals, including bovine mastitis in cattle and nocardiosis in horses.

### History

*Nocardia* infection was first described by French veterinarian Edmund Nocard in a pulmonary and cutaneous disease of cattle. The genus *Nocardia* is named so in honor of the scientist.

### Properties of the Bacteria

#### ► Morphology

*Nocardia* show the following features:

- *Nocardia* are Gram-positive bacilli showing a branching, beaded, and filamentous form.
- They stain poorly with Gram stain and appear to be Gram negative with intracellular Gram-positive granules.
- *Nocardia* organisms like that of mycobacteria contain mycolic acid in their cell wall. They are usually weakly acid fast. Acid fastness is a property of *Nocardia* by which it can be differentiated from other similar bacteria, such as actinomycetes.

#### ► Culture

*Nocardia* are strictly aerobic bacteria. They readily grow on commonly used routine media, such as nutrient agar, Sabouraud's dextrose agar, BHI agar, and yeast extract malt extract agar. Presence of 5–10% of CO<sub>2</sub> facilitates the growth of the bacteria.

*Nocardia* are slow-growing bacteria and, therefore, need prolonged incubation of 7 days or more for their culture and isolation in the media. *Nocardia* on these media produces colonies varying from dry to waxy and white to orange in color.

Buffered charcoal yeast extract (BCYE) agar is a selective medium used for isolation of *Nocardia* from the specimens potentially contaminated with other bacteria.

#### ► Biochemical reactions

*Nocardia* are catalase positive and they use sugars oxidatively. They produce acid from glucose and they utilize urea.

TABLE 46-2

**Biochemical characteristics of  
*Nocardia asteroides* complex and  
*Nocardia brasiliensis***

Tests	<i>Nocardia asteroides</i> complex	<i>Nocardia brasiliensis</i>
<b>Decomposition of:</b>		
Urea	+	+
Gelatin	–	+
Casein	–	+
Tyrosine	–	+
<b>Production of acid from:</b>		
Glucose	+	+
Rhamnose	+/-	–

Biochemical reactions of different *Nocardia* species are summarized in Table 46-2.

## Pathogenesis and Immunity

*Nocardia* species are opportunistic pathogens. *Nocardia* causes suppurative necrosis with the formation of abscesses at the site of infection. These species cause following infections:

- **Cutaneous nocardiosis** arises from the local trauma into the surface of the skin, which facilitates entry of the organism into subcutaneous tissues.
- **Pleuropulmonary disease** occurs most commonly due to inhalation of infectious aerosols. This condition is most commonly seen in immunocompromised individuals, including the patients with AIDS (acquired immunodeficiency syndrome) and the patients receiving immunosuppressive therapy. The condition is also common in patients with chronic pulmonary disease such as emphysema, bronchitis, bronchiectasis, etc. The infection begins after colonization of the oropharynx by inhalation of infective aerosols. This is followed by aspiration of pleural secretions into the lower respiratory tract. Disseminated infection is usually secondary to pleuropulmonary infection that has occurred earlier in the lungs. The disseminated infection occurs most commonly in individuals receiving immunosuppressive therapy or with underlying immunocompromised diseases. The patients who have received organ, bone marrow, or stem cell transplantation and patients with cirrhosis, lymphoreticular malignancies, and SLE (systemic lupus erythematosus) are more susceptible to infection.

*N. asteroides* is the most important species causing approximately 90% of human infections.

## Clinical Syndromes

Clinical manifestations of disease caused by *Nocardia* depend on the site of infection. *Nocardia* causes following infections:

### ► Primary cutaneous nocardiosis

Primary cutaneous nocardiosis may manifest as cutaneous infection and lymphocutaneous infection. Cutaneous infection may occur through wound contamination or by trauma. Usually feet and hands are involved.

**Cutaneous infection:** Actinomycotic mycetoma is the important lesion of cutaneous infection. Cutaneous infection may occur through wound contamination or by trauma. Usually feet and hands are involved. This condition is a painless chronic infection of the skin, characterized by subcutaneous swelling, suppuration, and presence of multiple sinuses. This is an invasive and destructive infection in which underlying bone and connective tissues are destroyed. As the infection progresses, multiple sinuses open to the surface of the skin with exudation or pus. The pus typically contains sulfur granules, which consist of filamentous *Nocardia* bound together by calcium phosphate.

**Lymphocutaneous infection:** The condition is characterized by the presence of cutaneous nodules and ulcers associated with lymphadenopathy. The lymphadenopathy also may occasionally drain purulent pus.

### ► Bronchopulmonary infection

Bronchopulmonary infection is one of the important clinical manifestations in most patients with nocardiosis. Presence of inflammatory endobronchial masses, localized or generalized abscesses are the manifestations of the condition. The condition is associated with formation of cavities, abscesses in the lungs, and pleural effusion. Cough with production of sputum and fever are the common symptoms. Clinically, this condition cannot be distinguished from infections of other microbial etiology.

### ► Secondary CNS infection

The condition manifests as chronic meningitis or as manifestation of single or multiple abscesses in the brain. CNS nocardiosis presents as slow, progressing mass lesion and is found in 20–40% of disseminated nocardial infection.

## Epidemiology

### ► Geographical distribution

Nocardial infections are reported worldwide, but no reliable estimates are available.

### ► Habitat

*Nocardia* are distributed in the soil rich in organic matter. They are present as transient pathogens in humans.

### ► Reservoir, source, and transmission of infection

*Nocardia* spp. that colonize the normal humans usually do not cause any infection in the same host. *Nocardia* organisms are exogenous pathogens. The infection is acquired by inhalation of infective aerosols or by penetration through the skin.

Pulmonary and disseminated nocardiosis are increasingly found in the immunocompromised individuals. The infections are much more common in patients with HIV or patients who have received organ, bone marrow, or stem cell transplantation and in patients with cirrhosis, lymphoreticular malignancies, and SLE. The condition is also more common in patients with chronic pulmonary disease, such as emphysema, bronchitis, bronchiectasis, etc.

## Laboratory Diagnosis

Laboratory diagnosis of nocardiosis depends on the demonstration of *Nocardia* by microscopy and isolation by culture.

### ► Specimens

Nature of the clinical specimens depends on clinical presentation of nocardiosis. Sputum is a frequently used specimen. Other specimens include respiratory secretions, skin biopsies, or pus from the abscesses.

### ► Microscopy

Diagnosis is made by demonstration of branching actinomycotic filaments in pus or in multiple sputum specimens by microscopy. Smears from the specimen are stained by Gram or Ziehl-Neelsen method.

### Key Points

The granules collected from the cases of mycetoma are very useful for diagnosis:

- The granules of *N. brasiliensis*, *N. asteroides*, *N. caviae* are soft, white, and measure 0.5–1 mm in size. The granules crushed between two slides are stained with Gram staining and are examined for demonstration of Gram-positive thin filaments.
- The granules are first collected from pus specimens with an inoculating needle and then washed with saline. These granules are then stained with Giemsa or Ziehl-Neelsen method for presence of typical filamentous hyphae (Fig. 46-1, Color Photo 51).

### ► Culture

Pus, sputum, and granules are cultured on nutrient agar, BHI agar, and Sabouraud's agar and are incubated at 36°C for up to 3 weeks. Colonies on these media may appear as early as 7 days.

### ► Identification of bacteria

The colonies are identified on the basis of Gram-positive and weekly acid-fast filamentous bacilli and with other biochemical properties. All the species of the genus *Nocardia* (*N. asteroides* complex, *N. brasiliensis*, and *N. otitidiscaviarum*, *N. asteroides* complex including *N. asteroides*, *N. farcinica*, and *N. nova*) are identified by using a battery of biochemical tests (Table 46-2).

## Treatment

Sulfonamides are the drug of choice for the treatment of nocardiosis. Sulfadiazine is useful for treatment of CNS

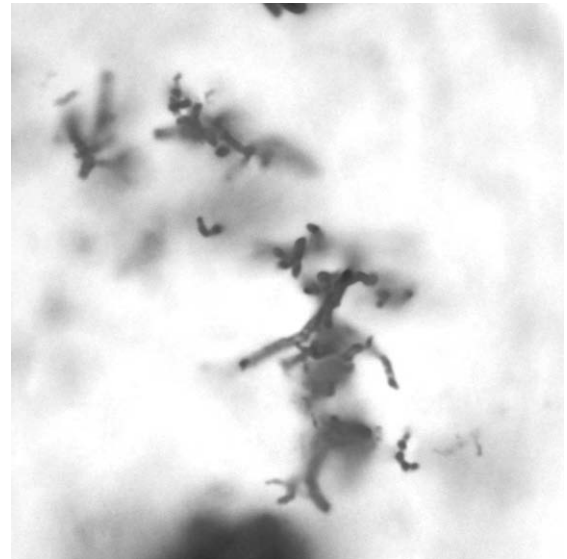

**FIG. 46-1.** Granules stained with Ziehl-Neelsen stain show the presence of typical filamentous hyphae ( $\times 1000$ ).

infections. Trimethoprim and sulfamethoxazole are considered better than sulfadiazine. *Nocardia* are also susceptible to carbapenems, such as imipenem and cilastatin, cefotaxime or ceftriaxone and amikacin.

## Prevention and Control

Prophylactic antibiotic therapy with trimethoprim and sulfamethoxazole has been shown to be of some value in prevention of the disease.

## Rhodococcus

The genus *Rhodococcus* organisms are Gram-positive and strict aerobic actinomycetes. The cell wall of *Rhodococcus* organisms is similar to those of mycobacterium by containing mycolic acid and tuberculostearic acid, which makes the bacteria acid fast. The genus contains 20 species out of which at least seven species are known to cause disease in humans.

*Rhodococcus equi*, formerly known as *Corynebacterium equi*, is the most important human pathogen. *R. equi* is a pleomorphic Gram-positive coccobacillus showing some degrees of branching. It is weakly acid fast. *Rhodococcus* grows well on routinely used media aerobically. On blood agar, on prolonged incubation at room temperature, the bacteria produce colonies resembling those of *Klebsiella*, with production of pink pigments. The bacteria do not ferment carbohydrates and show a variable biochemical reaction. *R. equi* is an intracellular pathogen, which multiplies in macrophages. This causes granulomatous reaction, resulting in the formation of abscess. The bacteria cause invasive pulmonary disease, such as pneumonic and lung abscess. Subsequently, the infection may spread to distant sites of the body causing meningitis, pericarditis, etc.

In immunocompetent hosts, rhodococci cause opportunistic infections, such as traumatic endophthalmitis, peritonitis in patients undergoing dialysis, and post-traumatic skin infection. The diagnosis of the condition is made by demonstration of weakly acid-fast and Gram-positive pleomorphic bacilli in clinical specimens. Definitive diagnosis by culture is often difficult. Rhodococci are difficult bacteria to treat, particularly in immunocompromised patients. They are resistant to penicillins and cephalosporins. Treatment with vancomycin or combination of erythromycin and rifampicin is effective.

### ***Gordonia* and *Tsukamurella***

Genera *Gordonia* and *Tsukamurella* are usually present in soil. They were earlier classified with *Rhodococcus*, because of their morphological similarities to it. These bacteria contain mycolic acid in their cell wall and are acid fast. Genus *Gordonia* organisms are rare opportunistic pathogens, which cause infection in humans. They have been associated with pulmonary and cutaneous infections. *Tsukamurella* has been associated with catheter infections.

### **Thermophilic *Actinomyces***

They are a group of bacteria that are commonly found in decaying vegetations. *Thermoactinomyces*, *Saccharopolyspora*, and *Saccharomonospora* are some important genera that have been associated with occasional human infections.

### ***Tropheryma whippelii***

*Tropheryma whippelii* is an actinomycete known to cause Whipple's disease. The bacterium is yet to be cultured. It is usually identified by molecular techniques. Whipple's disease manifests as abdominal pain, diarrhea, fever, lymphadenopathy, pigmentation of the skin, and arthralgia. The condition is diagnosed by demonstration of the periodic acid-Schiff (PAS)-positive inclusion bodies found inside macrophages of the lamina propria of the small intestine. Detection of bacterial genome by PCR in intestinal tissue confirms the diagnosis.

### ***Dermatophilus***

*Dermatophilus* is an actinomycete that causes an exudative dermatitis affecting skin of the hands and feet. The condition is commonly seen in individuals who are in close contact with infected animals or contaminated animal products. These pathogens are susceptible to commonly used antibiotics, such as penicillins and aminoglycosides. *Dermatophilus* is commonly found in the soil.

### ***Oerskovia***

*Oerskovia* is an actinomycete that causes opportunistic infection in humans. The bacterium is associated with cervicofacial infections, catheter-associated bacteremia, traumatic endophthalmitis, CNS shunt infections, and infection in patients undergoing long-term peritoneal dialysis. They are usually resistant to antibiotics.



### CASE STUDY

A 55-year-old man attended the dental OPD with a swelling of the soft tissue of the perimandibular area with sinus tracts discharging purulent material. The material containing yellow granules was sent to the microbiology laboratory for identification. Microscopy of smears made from granules showed Gram-positive hyphal fragments surrounded by peripheral zone of swollen, radiating, club-shaped structures presenting a sun-ray appearance.

- Identify the bacteria.
- Describe the culture methods for isolation of the bacteria.
- Describe other infections caused by the bacteria.
- Add a note on the virulence of the bacteria.

# Miscellaneous Bacteria

## Introduction

This chapter includes a wide range of various groups of bacteria that have been associated with human infections. Important bacteria are *Listeria monocytogenes*, *Erysipelothrix rhusiopathiae*, *Alcaligenes faecalis*, *Chromobacterium violaceum*, *Flavobacterium meningosepticum*, *Calymmatobacterium granulomatis*, *Streptobacillus moniliformis*, *Spirillum minus*, *Legionella pneumophila*, *Bartonella* species, *Capnocytophaga* species, and *Gardnerella vaginalis*.

## *Listeria monocytogenes*

*L. monocytogenes* is a small ( $1-3 \times 0.5 \mu\text{m}$ ) Gram-positive bacillus with a tendency to occur in chains. Typically, the bacteria show a slow tumbling type of motility by means of peritrichous flagella at 22–25°C, but are nonmotile at 37°C. The bacterium is aerobic or microaerophilic. It grows between 35 and 37°C and in the presence of reduced oxygen tension and 5–10% CO<sub>2</sub>. It is nonsporing, noncapsulated, and non-acid fast. *L. monocytogenes* grows on ordinary medium, but grows better on blood agar and tryptose phosphate agar. The bacteria on blood agar after 24 hours incubation produce smooth, round, translucent, easily emulsifiable, and nonpigmented colonies. On blood agar, they produce a narrow zone of weak beta hemolysis. Due to this hemolysis, the colonies of *L. monocytogenes* may be confused with those of group B streptococci. *L. monocytogenes* differs from group B streptococci by following tests:

1. It is motile, catalase positive, and shows positive CAMP (Christie, Atkins, and Munch-Peterson) reaction and negative hippurate hydrolysis test.
2. In CAMP reaction, *L. monocytogenes* produces a block type of hemolysis unlike that of arrow-head hemolysis produced by group B streptococci.

*L. monocytogenes* ferments sugars like glucose, salicine, and aesculin with production of acid. It is MR (methyl red) and VP (Voges-Proskauer) test positive but oxidase, urease, indole, and H<sub>2</sub>S negative. Hemolysin, a protein, is an important virulence factor of *L. monocytogenes*. This is also known as *histolysin*. Histolysin is an extracellular, oxygen-labile, and cholesterol-sensitive protein of molecular weight 60,000 Da. It shows antigenic cross-reactivity with pneumolysin and streptolysin O.

*L. monocytogenes* produces a variety of infections in pregnant women, neonates, adults, and elderly people. The bacteria in nonpregnant ladies may cause asymptomatic or mild febrile illness. However, infection in pregnant ladies may cause abortion or stillbirth of the child. In nonpregnant females, asymptomatic infections of the genital tract may lead to infertility. *L. monocytogenes* in adults may cause meningitis, meningoencephalitis, septicemia, endocarditis, and brain abscess. Patients receiving immunosuppressive therapy, suffering from immunosuppressive disease, are more susceptible to the infection. *L. monocytogenes* may cause occupation-related infections in poultry workers, butchers, and veterinarians. Due to direct contact with infected animals or birds or other products, these people may develop cutaneous infections.

*L. monocytogenes* is distributed worldwide. It occurs as a saprophyte in soil, water, and sewage. It is also widely prevalent in different mammals or birds, fish, ticks, and crustaceans. The bacteria have been isolated from milk, cheese, and other milk products. The infection is transmitted by:

- ingestion of milk, milk products, and other food preparations contaminated with the bacteria;
- direct contact with infected animal or animal products; and
- inhalation of contaminated dust.

Many outbreaks of listeriosis caused by food contaminated with *Listeria* have been documented in Europe and North America. Nosocomial outbreaks of *Listeria* have also been documented in hospitals.

## Key Points

Laboratory diagnosis of listeriosis depends on the isolation of *L. monocytogenes* from clinical specimens by culture:

- Cervical and vaginal secretions, meconium, blood, cerebrospinal fluid (CSF), amniotic fluid, placenta, and biopsy are frequently used specimens for diagnosis.
- Gram staining of the CSF smear is useful for detection of bacteria. This is positive in nearly 50% of the cases.
- Specimens are cultured on blood agar, chocolate agar, and tryptose phosphate agar and incubated for 24–72 hours at 35–37°C. Isolation of bacteria is much more increased by cold enrichment. In this method, the specimens are stored in thioglycolate broth or tryptose phosphate at 4°C, and subcultures are carried out at weekly intervals for 1–6 months.

*L. monocytogenes* is sensitive to ampicillin, gentamicin, and cotrimoxazole. Cephalosporins are not useful for infections caused by *Listeria*.

### ***Erysipelothrix rhusiopathiae***

*E. rhusiopathiae* is a slender, straight or slightly curved, Gram-positive bacillus with a tendency toward formation of long filaments. It is nonmotile, nonsporing, and noncapsulated. It is catalase negative. It ferments glucose and lactose, producing acid but no gas. It is H<sub>2</sub>S negative. It is MR, VP, indole, urease, and nitrate reduction test negative. It is aerobic and facultative anaerobic. The growth is improved in the presence of 5–10% CO<sub>2</sub>.

- It can grow on nutrient agar and also on blood agar. After 24–48 hours of incubation, it produces convex and translucent colonies surrounded by a variable zone of alpha-hemolysis.
- On tellurite agar, it produces black colonies.

*E. rhusiopathiae* occurs as a saprophyte in soil, food, and water. It occurs as a natural parasite of swines, mice, rabbits, turkeys, and many other animals.

*E. rhusiopathiae* in humans causes septicemia, endocarditis, and erysipeloid. The latter is a localized infection of the skin that resembles streptococcal erysipelas. These cutaneous lesions are painful, edematous, and erythematous. They usually occur on the hands or fingers of persons handling animals, fish, or animal products. The cutaneous lesions are usually associated with arthritis, lymphopharyngitis, or lymphadenitis.

Diagnosis of the condition is made by the isolation of *E. rhusiopathiae* from pus and other clinical specimens by culture. The bacillus is sensitive to penicillin, erythromycin, ampicillin, methicillin, ciprofloxacin, and clindamycin.

### ***Alcaligenes faecalis***

*A. faecalis* are Gram-negative, small, nonsporing bacilli. They are motile due to presence of peritrichous flagella. They are strict aerobes and do not ferment sugars. They are usually oxidase positive. *A. faecalis* occurs as a saprophyte in water and soil contaminated with putrefied decayed organic matter. The bacteria are also found as commensals in the gastrointestinal tracts of humans and animals. The bacterium causes urinary tract infection, infantile gastroenteritis, and typhoid-like fever in humans.

### ***Chromobacterium violaceum***

*C. violaceum* is a Gram-negative bacillus. It is catalase and oxidase positive but indole and urease negative. It is a motile bacterium due to presence of polar and lateral flagella. It is aerobic and facultative anaerobic. It grows on nutrient agar producing a nondiffusible violet pigment, which is soluble in

ethanol and insoluble in chloroform and water. *C. violaceum* is found as saprophytes in water and soil, and in tropical and subtropical countries. Intestinal and genitourinary infections and septicemic illnesses with pneumonia are rare human infections associated with the bacteria. The bacillus is sensitive to erythromycin, tetracycline, carbenicillin, ceftioxin, etc.

### ***Flavobacterium meningosepticum***

*F. meningosepticum* is a Gram-negative, nonsporing, and nonmotile bacterium. It is catalase and oxidase positive and weakly fermentative. It can grow on ordinary medium, such as nutrient agar. It produces smooth, circular, and glistening colonies after 24 hours of incubation at 37°C. On incubation at room temperature for 48 hours, it produces yellow, nondiffusible pigment on the nutrient agar. *F. meningosepticum* is a ubiquitous saprophyte present in soil, water, food stuff, and moist environment. It can cause opportunistic infections and also neonatal meningitis in premature infants and pneumonia in immunocompromised hosts. In immunocompetent adults, it causes a mild illness. Novobiocin, rifampicin, clindamycin, and ceftioxin are effective for treatment of *F. meningosepticum* infections.

### ***Calymmatobacterium***

*Calymmatobacterium* (*Donovania*) *granulomatis* is the causative agent of granuloma inguinale, a granulomatous disease, which involves the genital and inguinal part of the infected host. *C. granulomatis* was first discovered by Donovan in 1905. He demonstrated the characteristic intracellular bodies in stained smears of pus from ulcer of a patient suffering from donovanosis, a sexually transmitted disease first described in India by Mac Leod. *C. granulomatis* is a small Gram-negative coccobacillus, which measures 1–2 × 0.5–1.5 μm in size. The bacterium often shows bipolar staining, giving rise to safety-pin appearance. It is a capsulated bacterium but is nonmotile, nonsporing, and non-acid fast. It can be grown with difficulty on egg yolk medium or modified Levinthal agar. The bacterium grows readily in the yolk sac of embryonated egg.

*C. granulomatis* causes granuloma inguinale, which has an incubation period of few weeks to months. The condition manifests as the presence of subcutaneous nodules on genital organs or in inguinal area. Subsequently, these nodules suppurate and break down, leading to formation of painless granulomatous lesions.

Granuloma inguinale is seen in Caribbean islands and New Guinea. The condition is a sexually transmitted disease, transmitted through sexual contact. These organisms are found in the cytoplasm of histiocytes, polymorphonuclear leukocytes or remain free outside the cell. These are called **Donovan bodies**. About 1–25 bacteria can be found within a mononuclear phagocyte.



Laboratory diagnosis of the condition is made by demonstrating these characteristic Donovan bodies within mononuclear phagocytes. Specimen is collected by scraping the border of the ulcerative lesion and making a smear on a glass slide. The smears are stained with Giemsa or Wright stains. In the stained smear, the body of the bacillus is stained blue and the capsule is stained pink.

Tetracyclines, erythromycin, and trimethoprim-sulfamethoxazole are effective for treatment of the condition.

## Streptobacillus and Spirillum

*Streptobacillus moniliformis* and *Spirillum minus* are the natural pathogens of rodents. Both these agents cause a same condition called rat-bite fever.

## Streptobacillus moniliformis

*S. moniliformis* is a pleomorphic Gram-negative bacillus (0.1–0.5 × 1–5 μm) that stains poorly with Gram staining. The bacteria may appear as a string of beads containing granules. The bacterium may lose its cell wall and readily develop into L forms. *S. moniliformis* is an aerobe and facultative anaerobe and highly fastidious bacterium. It is catalase, oxidase, indole, urease, and nitrate negative. It ferments glucose with production of acid but no gas. The bacterium is a slow grower. It grows on enriched media supplemented with 15% blood, 20% horse or calf serum, or 5% ascitic fluid. It produces discrete, granular or smooth, gray colonies after 3 days of incubation at 35–36°C in a humid aerobic condition. *S. moniliformis* causes rat-bite fever, a condition characterized by relapsing fever, rash, and arthralgia. Incubation period varies from 2 to 10 days. The condition manifests with sudden onset of fever, headache, myalgias followed by a petechial rash and arthritis. In untreated cases, relapses are common.

Rat-bite fever is usually caused by the bite of a rat or occasionally by the bite of a mouse, cat, squirrel, or dog. The disease also occurs without rat bite and is believed to occur due to ingestion of raw meat or water contaminated by excreta of the rat. This condition is known as *Haverhill's fever* or *erythema arthriticum epidemicum*.

### Key Points

- Laboratory diagnosis of the condition is made by culture of the bacillus from blood or other body fluids.
- Serological tests, such as indirect fluorescent antibody (IFA) test, complement fixation test, and agglutination test are frequently useful for diagnosis. All these tests use *S. moniliformis* as antigen.
- A serum titer of 1:80 or more, or a fourfold rise between acute and convalescent sera is considered diagnostic of the disease.

Penicillin is the antibiotic of choice for treatment of cases of rat-bite fever. Cephalosporins, erythromycin, clindamycin, and tetracycline are also used to treat the condition.

## Spirillum minus

*S. minus* is a short, spiral, Gram-negative bacillus and measures 0.2–0.5 × 3–5 μm in size. It is a motile bacterium with the presence of 1–5 amphitrichous flagella. The bacteria stain poorly with Gram stain, but stain better with Giemsa or Fontana stains. *S. minus* also causes rat-bite fever similar to that caused by *S. moniliformis*, but with few differences in the clinical manifestations:

- Rat-bite fever caused by *S. minus* has a long incubation period of 2–4 weeks.
- The condition may manifest as suppuration of the rat-bite wound, and the onset of fever is associated with regional lymphadenopathy.
- Mortality is relatively less (6%) in untreated cases.

Other clinical manifestations of rat bite are similar to that caused by *S. moniliformis*. *S. minus* organisms like the *S. moniliformis* are found in the nasopharynx of rats and other small rodents. They are transmitted to humans by the bite of these animals but not by contaminated water or milk as seen with *S. moniliformis*.

Dark field microscopic examination of blood, pus, or lymph node aspirate is useful to demonstrate *S. minus*. Microscopy of Giemsa- or Wright-stained blood smear is also useful. Animal inoculation is a frequently used method for diagnosis. In this method, clinical specimens are inoculated intraperitoneally into rodents following which these pathogens can be demonstrated in the blood and the peritoneal fluid of these rodents, 1–3 weeks after inoculation.

Serology is not useful. Rat-bite fever caused by *S. minus* can be treated with both penicillin and tetracycline. Table 47-1 shows a comparison between rat-bite fever caused by *Streptobacillus* and *Spirillum* species.

## Legionella

*Legionella* are ubiquitous aquatic saprophytes present worldwide. Many of these species are found in the environment and are also associated with human infections. *L. pneumophila* is an important species, which causes both community-acquired and nosocomial pneumonia.

## History

*Legionella* as the causative agent of pneumonia was first identified in 1976 during the annual convention of American Legion held at a hotel in Philadelphia. The infection was believed to be transmitted from the contaminated water in the hotel's air conditioning system. A total of 182 cases were detected; of which 29 patients died because of the disease. The disease was characterized by fever, cough, and chest pain, leading to pneumonia and often death of the patient. This condition was referred to as *Legionnaire's disease*, and the causative agent isolated from the fatal cases was designated as *L. pneumophila*.

Family Legionellaceae consists of one genus, *Legionella* which contains 39 genetically defined species and more than

TABLE 47-1

Comparison of rat-bite fever caused by *Streptobacillus* and *Spirillum* species

	<i>Streptobacillus moniliformis</i>	<i>Spirillum minus</i>
<b>Incubation period</b>	Short (10 days)	Long (15 days)
<b>Symptoms</b>	High fever, headache, chills, myalgia, rash, arthritis, arthralgia; and recurrent fever if untreated	Fever, headache, chills, rash, lymphangitis, lymphadenitis; and recurrent fever if untreated
<b>Diagnosis</b>	Culture and serology	Dark ground microscopy, microscopy of Giemsa-stained blood smear, and animal inoculation
<b>Antibiotic therapy</b>	Penicillin (L forms not sensitive to penicillin). Both forms sensitive to streptomycin and tetracycline.	Penicillin In case of endocarditis, addition of an aminoglycoside
<b>Mortality</b>	Higher if untreated (10%)	Lower if untreated (6%)

60 serogroups. Many of these species cause infections in humans. *Legionellosis* is the term used for infections caused by different *Legionella* species. *Legionnaire's disease* is the term used to describe the pneumonia caused by *L. pneumophila*.

## *Legionella pneumophila*

*L. pneumophila* is the causative agent of Legionnaire's disease, as well as of Pontiac fever.

### Properties of the Bacteria

#### ► Morphology

*L. pneumophila* shows following features:

- *L. pneumophila* is a small, slender, pleomorphic, Gram-negative bacillus.
- *L. pneumophila* organisms in clinical specimens stain poorly with Gram staining. They can be stained better by silver impregnation method using Dieterle silver stain.
- It measures  $0.3\text{--}0.9 \times 2\text{--}5 \mu\text{m}$  with pointed ends and tendency to form filaments in culture on solid media.
- It is motile by means of one or more polar or subpolar flagella.
- It is nonsporing and non-acid fast.

#### ► Culture

*L. pneumophila* is a strict aerobe, grows at an optimum temperature of  $35^\circ\text{C}$  and an optimum pH of 6.9. It is nutritionally fastidious and grows on the medium supplemented with iron salts and L-cysteine.

**Buffered charcoal yeast extract (BCYE) agar:** The agar containing buffered charcoal, yeast extract, and cysteine is a useful medium for growth of *L. pneumophila*. It is a slow-growing bacterium and may take 3–5 days to produce visible colonies. The colonies on BCYE agar are circular, gray, or gray-blue and low convex with a slightly irregular margin. Under the microscope, the colonies typically have a ground glass appearance.

#### ► Biochemical reactions

*L. pneumophila* shows following biochemical properties:

- It is mostly nonfermenter and derives its energy from the metabolism of amino acids.
- It does not ferment any sugars and is urease and nitrate test negative.
- It is catalase positive, oxidase variable, and liquefies gelatin.
- It hydrolyzes starch and hippurate.

#### ► Other properties

**Susceptibility to physical and chemical agents:** *L. pneumophila* is readily killed by 70% ethyl alcohol, 2% glutaraldehyde, and 1% formaldehyde. It is also killed by residual chlorine (5 ppm of chlorine) in chlorinated water in 1 minute, by 1.25 ppm of chlorine in 15 minutes, and by 0.65 ppm of chlorine in 1 hour.

### Cell Wall Components and Antigenic Structure

On the basis of direct immunofluorescence and slide agglutination tests, a total of 15 serogroups (1–15) of *L. pneumophila* have been identified. Of these, three serogroups (1, 4, and 6) are primarily associated with human disease.

Nearly, 80% of the cases of legionellosis disease caused by *L. pneumophila* are believed due to serogroup 1. *L. pneumophila* possesses both flagellar and somatic antigens.

### Pathogenesis and Immunity

*L. pneumophila* is an obligate or facultative intracellular pathogen.

#### ► Virulence factors

The capability of the bacteria to multiply in macrophages and their ability to prevent phagolysosome fusion are the main determinants of virulence of the bacteria. *L. pneumophila* organisms possess many virulence factors, such as protease, hemolysin, and cytotoxin. Protease is an important virulence factor, which plays an important role in causing infection.

### ► Pathogenesis of Legionnaire's disease

The bacteria infect human monocytes and alveolar macrophages. The bacteria multiply in macrophages and monocytes by binding complement to an outer membrane porin protein and subsequent deposition of C3b, a component of the complement on the surface of the bacteria. This facilitates them to combine with CR3 complement receptors on phagocytes and enter the cell through endocytosis. Once inside the cell, the bacteria are not killed because they prevent fusion of phagolysosome. Subsequently, the bacteria multiply in large numbers in the intracellular vacuoles and produce many enzymes, such as phosphatase, lipase, nuclease, and proteolytic enzymes. Subsequently they lyse and kill the infected host cell.

### ► Host immunity

Cell-mediated immunity plays an important role in the host immunity by preventing the intracellular growth of *Legionella* spp. Sensitized T cells stimulate the increased antimicrobial activity of parasitized macrophages. Humoral immunity plays a minor role.

## Clinical Syndromes

*L. pneumophila* causes two distinct clinical entities—Legionnaire's disease and Pontiac fever.

### ► Legionnaire's disease

Incubation period varies from 2 to 10 days. Pneumonia is the primary manifestation of Legionnaire's disease with multilobular consolidation, inflammation, and abscesses in the lung. Fever, chills, dry or nonproductive cough, and pleuritic or nonpleuritic chest pain are the common symptoms of the disease. Hemoptysis is rare. The condition becomes more severe and is associated with much morbidity and high mortality if not treated immediately.

Decreased pulmonary function, pulmonary fibrosis or scarring, abscess formation in the lungs, and fulminant

respiratory failure are the important complications of pulmonary disease. Progressive respiratory failure is the most common cause of death in patients with Legionnaire's disease. The mortality may be as high as 80% in untreated patients. It may be nearly 50% in nosocomial infections of patients with underlying diseases. Extrapulmonary manifestations include myocarditis, pericarditis, and prosthetic valve endocarditis. They also include peritonitis and acute renal failure.

### ► Pontiac fever

Pontiac fever is a mild, self-limiting condition. The condition presents as fever and myalgia that resolve without treatment. Table 47-2 compares the Legionnaire's disease and Pontiac fever caused by *L. pneumophila*.

## Epidemiology

### ► Geographical distribution

Legionnaire's disease is prevalent worldwide. This is responsible for 2–15% of all community-acquired pneumonia that requires hospitalization.

### ► Habitat

*L. pneumophila* is an obligate intracellular pathogen found in alveolar macrophages in the infected human host.

### ► Reservoir, source, and transmission of infection

*L. pneumophila* is a saprophyte widely found in aquatic environments. The bacteria have been isolated from a variety of man-made water environments, such as hot water system in hotels and hospitals, cooling water system, air conditioning cooling towers, shower heads, industrial coolants, and respiratory ventilators.

The factors that contribute to the presence of these bacteria in these environments include (a) stagnation of water, (b) temperature of water varying from 25 to 40°C, and (c) presence of free-living amoeba, such as *Acanthamoeba* and *Bartonella* species,

TABLE 47-2

Comparison of Legionnaire's disease and pontiac fever caused by *Legionella pneumophila*

	Legionnaire's disease	Pontiac fever
Incubation period	2–10 days	1–2 days
Disease	More severe, much morbidity, and causes death if therapy not started promptly	Mild febrile illness, minimal morbidity, and causes no death if resolved spontaneously
Mortality	Higher if delay in treatment (15–20%)	Negligible (less than 1%)
Antibiotic therapy	Needed	Not needed, self-limited
Distribution	Epidemic and sporadic	Epidemic
Reservoir	No animal or human reservoir	No animal or human reservoir
Source	Contaminated water source	Contaminated water source
Pathogenesis	Legionellae engulfed by monocytes and survive as intracellular parasites. Subsequently, lyse and kill infected host cell	Pathogenesis not well understood

which support the growth of *Legionella*. Therefore, contaminated water is the primary source of infection. Transmission to humans occurs by the following routes:

- Inhalation of aerosolized mist from contaminated water source, which is contaminated with either the bacteria or free-living amoeba infected with the bacteria.
- Nosocomial infection is transmitted through aspiration, contaminated water, or respiratory equipments.
- Infection is also transmitted by the use of nebulizers, humidifiers, and other instruments that have been washed with contaminated tap water.

Person-to-person transmission does not occur. Animals also do not play any role in transmission of the infection. The elderly people, people with chronic heart or lung diseases, and the patients who are in immunocompromised state or are receiving immunosuppressive therapy are at greatest risk for the disease. This is because of their depressed cell-mediated immunity and altered pulmonary functions.

## Laboratory Diagnosis

### ► Specimens

Sputum, lung fluid, pleural fluid, transtracheal aspirations, and bronchoalveolar lavage fluid are the respiratory specimens frequently used for the diagnosis of the condition. Blood is also used for culture.

### ► Microscopy

Gram staining of the sputum or other respiratory specimens may show many leukocytes, but the organisms are rarely demonstrated. Bacteria, if found, are very poorly stained. Dieterle silver or Gimenez stain can be used to demonstrate bacteria.

### ► Direct antigen detection

Direct fluorescent antibody (DFA) test is a sensitive method to detect *Legionella* spp. in sputum and other specimens.

This test uses fluorescent-labeled monoclonal or polyclonal antibodies produced against *Legionella* species. This is a rapid test; result can be obtained within 2–4 hours. The test shows a high specificity of 96–99% using the monoclonal antibodies. However, this test has a low sensitivity.

The sensitivity of DFA depends on the presence of a large number of bacteria in specimen. Therefore, sensitivity is increased if samples from lower respiratory tract are used. Positive DFA test becomes negative in 4–6 days of treatment.

### ► Culture

Isolation of *Legionella* spp. from sputum or other respiratory secretions (bronchoalveolar lavage, transtracheal aspiration, and bronchoscopic specimens) by culture is the definitive method for diagnosis of *Legionella* infection. Blood culture shows very low sensitivity.

BCYE agar is the medium most frequently used for culture of the bacteria. The bacteria produce small colonies after 3–5 days of incubation on BCYE agar at 35°C in the presence of 3–5% CO<sub>2</sub>. Bronchoalveolar lavage, transtracheal aspiration, and bronchoscopic specimens increase the sensitivity of the culture. However, blood culture shows very low sensitivity.

### ► Serodiagnosis

IFA test and ELISA are the most commonly used antibody-based serological tests for the diagnosis of *Legionella* infection. IFA titer of 1:256 or more on a single serum is diagnostic. A fourfold or greater increase in antibody titer between acute and convalescent serum to 1:128 or greater in titer is also considered diagnostic of the disease.

### ► Antigen detection

ELISA, radio immunoassay (RIA), and the latex agglutination test are used to detect *Legionella* lipopolysaccharide antigen in the urine and respiratory specimens. The antigens are demonstrated in more than two-thirds of the patients during 1–3 days of clinical disease. The urinary antigen detection is relatively rapid and simple and can even detect antigen excreted in patients who are on antibiotic therapy. Disadvantage of the test is that it can detect only *L. pneumophila* (serogroup 1 antigen). The antigens continue to be present in urine even for months after the infection has resolved.

## Molecular Diagnosis

Polymerase chain reaction (PCR) is a specific method for detection of *Legionella* spp. in urine, serum, and bronchoalveolar lavage fluid. The main advantage of this method is that it can detect infections caused by *Legionella* species other than *L. pneumophila* serogroup 1.

## Treatment

Erythromycin or tetracycline is useful for treatment of community-acquired infections. Fluoroquinolones, such as doxycycline, telithromycin, and azithromycin, are recommended for treatment of severe cases. Beta-lactam antibiotics and aminoglycosides are not useful.

## Prevention and Control

Hyperchlorination of water and superheating of water to 70–80°C has proved to be of value in preventing the disease. Complete elimination of bacteria from water, however, is difficult.

## Bartonella

Members of the genus *Bartonella* are very small Gram-negative bacilli transmitted by arthropods. The bacteria are Gram-negative aerobic bacilli and are fastidious in growth. They cause

TABLE 47-3

Human infections caused by *Bartonella* species

Bacteria	Diseases
<i>Bartonella bacilliformis</i>	Oroya fever
<i>Bartonella quintana</i>	Trench fever
<i>Bartonella clarridgeiae</i>	Endocarditis
<i>Bartonella elizabethae</i>	Endocarditis
<i>Bartonella henselae</i>	Bacillary peliosis Bacillary angiomatosis Cat-scratch disease

infections in mammalian host by invading endothelial cells and red blood cells. *Bartonella* species are found in a variety of animal hosts and are typically present without evidence of the disease. The genus *Bartonella* consists of 11 species, of which five are associated with human diseases (Table 47-3).

### *Bartonella bacilliformis*

*B. bacilliformis* is the causative agent of Oroya fever, an acute febrile illness consisting of severe anemia. This condition was first identified in the mountainous parts of Peru in 1870 during the laying of railway lines from Lima to Oroya in Peru. The outbreak of Oroya fever killed 1000 of workers associated with this railway project.

*B. bacilliformis* are short Gram-negative coccobacilli measuring  $0.3\text{--}0.5 \times 1.0\text{--}1.7 \mu\text{m}$ . The bacteria occur singly, in pairs, in chains, or in clumps. They are motile by the presence of as many as 10 flagella at one pole of the bacteria. They are aerobic and require an optimum pH of 7.8 and optimum temperature of  $25\text{--}28^\circ\text{C}$  for their growth.

Oroya fever is restricted in its geographical distribution and is mainly confined to Peru, Columbia, and Ecuador in South America.

The laboratory diagnosis of the condition is made by demonstration of intracellular bacteria in blood smear stained by Giemsa. The bacteria are found in the cytoplasm. Bacteria can be isolated from blood in enriched blood agar.

Penicillin, streptomycin, tetracycline, and chloramphenicol are effective for the treatment of *B. bacilliformis* infection. Use of insecticides, such as DDT to kill the sand fly prevents transmission of the disease.

### *Bartonella quintana*

*B. quintana* was earlier known as *Rochalimaea quintana* as a causative agent of trench fever or five-day fever. This condition was first recognized in the soldiers fighting in trenches in Europe during the first World War. The causative agent was earlier identified as a rickettsia and named *Rickettsia quintana* because it caused a five-day fever (from *quintana*, means fifth), a synonym for trench fever. The organism subsequently was found not to be a rickettsia and differed from latter by its ability to grow in cell-free media, such as blood agar, hence

was separated into a new genus *Rochalimaea*. Currently, it has undergone further taxonomical classification and has been reclassified as *B. quintana*.

*B. quintana* is a small Gram-negative bacillus ( $0.3\text{--}0.5 \times 1.0\text{--}1.7 \mu\text{m}$ ) and is nonmotile. It grows slowly on sheep or rabbit blood agar at  $37^\circ\text{C}$  in presence of 5%  $\text{CO}_2$ . It requires prolonged incubation of 1–2 weeks to produce demonstrable colonies.

*B. quintana* is transmitted by the body louse. The lice become infectious 5–9 days after feeding on a trench fever patient, after which the lice remain infectious throughout their life and excrete organisms in their feces. The infected lice when bites a new host defecates on surface of the skin. When this feces comes in contact with minor scratches or abrasions on the surface of the skin, the bacteria present in the feces enter the skin and initiate the infection.

Trench fever has an incubation period of 14–30 days. The condition can vary from asymptomatic to symptomatic infection. Severe headache, fever (giving the name of the disease as five-day fever), chills, weakness, and severe pain in the back and legs are the common manifestations of symptomatic cases. The condition is also associated with the presence of rashes on the chest, abdomen, or back. The infection does not cause death of the patient, but can produce a very severe debilitating illness. Trench fever is an exclusively human disease. No animal reservoir for this disease has been identified. The disease is transmitted from humans to humans by the human body louse vector.

### Key Points

- Laboratory diagnosis is made by isolation of the bacteria from patient's blood on blood agar after 2 weeks of incubation.
- The organism can also be demonstrated in lice after allowing the healthy lice to feed up on the patient (*xenodiagnosis*).
- Weil-Felix test used for diagnosis of rickettsial infection is negative in trench fever.
- The condition can be treated with gentamicin alone or with erythromycin.

### *Bartonella henselae*

*B. henselae* is the causative agent of cat-scratch disease. The disease follows scratches and bite of the cat or with the bite of cat fleas. *B. henselae* is a small Gram-negative bacillus measuring  $2.0\text{--}2.5 \times 0.5\text{--}0.6 \mu\text{m}$ . Like other *Bartonella* species, it can grow on chocolate agar or Columbia agar supplemented with 5% sheep or rabbit blood. *B. henselae* produces dry white cauliflower-like colonies after 5–15 days of incubation at  $35\text{--}37^\circ\text{C}$  in the presence of 5%  $\text{CO}_2$ .

*B. henselae* typically causes cat-scratch disease. It is a benign condition characterized by regional lymphadenopathy and fever. The cervical and axillary lymph nodes are most commonly affected. Usually, single lymph node is affected in 50% of the cases.

*B. henselae* also causes bacillary angiomatosis, a condition resembling Kaposi sarcoma in patients with AIDS. The skin, lymph nodes, or liver and spleen are primarily involved in this condition. The bacteria also cause subacute bacterial endocarditis.

Laboratory diagnosis is confirmed by demonstration of clusters of *B. henselae* in lymph node biopsy smears stained with Warthin Starry impregnation stain. The bacteria can also be isolated by culture on chocolate agar or Columbia agar enriched with sheep or rabbit blood on incubation for 3 weeks or more. Gentamicin and erythromycin are effective for the treatment of the condition.

### Capnocytophaga

Members of the genus *Capnocytophaga* are filamentous Gram-negative bacilli. They are slow-growing aerobic and anaerobic bacteria and require presence of CO<sub>2</sub> for their growth. The genus is classified into two groups: (a) dysgonic fermenter 1 (DF-1) and (b) dysgonic fermenter 2 (DF-2):

- **DF-1 group** consists of three species: *Capnocytophaga ochracea*, *Capnocytophaga gingivalis*, and *Capnocytophaga sputigena*, which are found as members of the normal flora of oropharynx in humans. These species have been associated with periodontitis and bacteremia. They occasionally cause severe systemic disease, such as endocarditis in immunocompromised host.
- **DF-2 group** bacteria are found only in dogs and not in humans.

Most *Capnocytophaga* strains are resistant to aminoglycosides but are sensitive to broad-spectrum cephalosporins, fluoroquinolones, and penicillins.

### Gardnerella vaginalis

*G. vaginalis* was earlier known as *Corynebacterium vaginalis* or *Haemophilus vaginalis*. Since the bacterium does not require X and V growth factors, it has been shifted from the genus *Haemophilus* and has been placed in the genus *Gardnerella*. The bacterium is present as a commensal in the male urethra and vagina. *G. vaginalis* are small, pleomorphic, Gram-negative rods, which are sometimes Gram variable. They are nonsporing, nonmotile, and noncapsulated. *G. vaginalis* causes nonspecific vaginitis and cervicitis, frequently in association with anaerobic vaginosis. The condition is characterized by foul-smelling vaginal discharge with a fishy odor and acidic pH.

High vaginal swab or endocervical swab with exudate material is the specimen required for diagnosis of the condition. The specimens are transported in the Stuart medium. Gram staining of the smear shows Gram-variable small bacilli and presence of clue cells. These clue cells are the vaginal epithelial cells covered with many small Gram-variable rods. The bacteria is cultured on a blood agar and incubated anaerobically at 37°C for 48 hours for colonies. The colonies of *G. vaginalis* are identified by Gram staining, negative catalase test, and positive hippurate hydrolysis test.

*G. vaginalis* is sensitive to penicillin, ampicillin, and trimethoprim. It is resistant to gentamicin, nalidixic acid, and colistin. Metronidazole is the drug of choice.

### CASE STUDY

A 29-year-old software engineer working in Peru for the past 1 year came back to India with complaints of myalgia, arthralgia, headache, severe anemia, and also hepatosplenomegaly. Routine laboratory studies were negative. Blood smear stained by Giemsa stain showed intracellular bacteria. Blood culture showed colonies, which were identified as *Bartonella bacilliformis*.

- Diagnose the disease.
- What are the other laboratory tests used for diagnosis of the disease?
- How will you treat the condition?
- Is this condition present in India?

# *Rickettsia*, *Orientia*, *Ehrlichia*, and *Coxiella*

## Introduction

Rickettsiae are obligate, intracellular, very small ( $0.3 \times 1\text{--}2 \mu\text{m}$ ), Gram-negative bacilli that multiply within cytoplasm of eukaryotic cells. They have very small genome composed of 1–1.5 million base pairs. These organisms, because of their small size, were once thought to be viruses. Nevertheless, these organisms are bacteria because they show following characteristics:

1. They have typical Gram-negative cell walls.
2. They contain both DNA and RNA, enzymes for the Krebs cycle, and ribosomes for protein synthesis.
3. They multiply by binary fission.
4. They are susceptible to antibiotics.

Rickettsiae are primary pathogens of arthropods, such as lice, fleas, ticks, and mites. In these hosts, they are found in their intestinal tract. They are usually transmitted to humans by arthropod vectors, such as lice, mites, ticks, etc. *Coxiella burnetii* causing Q fever is an exception, which is transmitted usually by airborne droplets. They also infect humans in whom they are found in the reticuloendothelial cells and vascular endothelium.

## Classification

Rickettsiae are a group of bacteria that phylogenetically occupy a position between bacteria and viruses. These pathogens are included in the order Rickettsiales, tribe Rickettsiae, and family Rickettsiaceae. Family Rickettsiaceae comprises three genera: *Rickettsia*, *Orientia*, and *Ehrlichia*. Earlier the genus *Coxiella* was included in the family Rickettsiaceae but now has been excluded from it, because unlike other genera of the family Rickettsiaceae *Coxiella* organisms are not primarily obligate intracellular parasites. They can grow in cell-free media.

Rickettsiae are strict intracellular parasites, but their intracellular locations vary. *Rickettsia* and *Orientia* are free in cytoplasm, whereas *Coxiella* and *Ehrlichia* are found in cytoplasmic vacuoles. These bacteria synthesize proteins and produce adenosine diphosphate by tricarboxylic acid cycle. The exact reason why these bacteria grow inside cells is not understood. It is suggested that these bacteria are energy parasites, which use ATP in host cell till it is available. They also use available host amino acids and host cell coenzyme A and nicotinamide adenine dinucleotide.

Cell wall of all the four genera is typical of Gram-negative bacteria. They have lipopolysaccharide (LPS) and peptidoglycan layer. The LPS shows weak endotoxic activity. The bacteria

## Human infections caused by *Rickettsia*, *Orientia*, *Ehrlichia*, and *Coxiella* species

TABLE 48-1

Bacteria	Diseases
<i>Rickettsia prowazekii</i>	Epidemic or louse-borne typhus; relapsing louse-borne typhus or Brill-Zinsser's disease
<i>Rickettsia typhi</i>	Endemic or flea-borne murine typhus
<i>Rickettsia rickettsiae</i>	Rocky Mountain spotted fever
<i>Rickettsia akari</i>	Rickettsial pox
<i>Rickettsia conori</i>	Boutonneuse fever (i.e., Kenya tick bite fever, African tick typhus, Mediterranean spotted fever, Indian tick typhus, and Marseilles fever)
<i>Orientia tsutsugamushi</i>	Scrub typhus
<i>Ehrlichia sennetsu</i>	Sennetsu fever
<i>Ehrlichia chaffeensis</i>	Monocytic ehrlichiosis
<i>Ehrlichia phagocytophila</i>	Human granulocytic ehrlichiosis
<i>Coxiella burnetii</i>	Q fever
<i>Rickettsia australis</i>	Queensland tick typhus
<i>Rickettsia sibirica</i>	North Asian tick typhus

are nonmotile, they do not have any flagella, and instead are surrounded by a loose slime layer. Rickettsiae that cause human diseases are summarized in Table 48-1.

## Genus *Rickettsia*

*Rickettsia* organisms cause a wide variety of diseases varying considerably in severity from self-limiting illness to fulminating, life-threatening infection.

## Properties of the Bacteria

### ► Morphology

They are small, Gram-negative coccobacilli varying from 0.3–0.6 to 0.8–2  $\mu\text{m}$  in size. They are nonmotile and noncapsulated. They are stained poorly with Gram stain but are stained well with the following: deep red with Machiavello and Gimenez stain and bluish purple with Giemsa and Castaneda stain.

### ► Culture

Rickettsiae fail to grow on cell-free media. They usually grow inside the cell, usually in the cytoplasm (most *Rickettsia*) or in the nucleus of the cell (*Rickettsia* causing spotted fever).

They grow well at optimum temperature of 32–35°C. They grow in various cell lines, in the developing chick embryo, and also in many laboratory animals.

**Cell lines:** They grow on HeLa, Hep2, Detriot-6, mouse fibroblasts, and other continuous cells lines. Cultures in the cell lines are used primarily for the maintenance of *Rickettsia* but are not useful for primary isolation of *Rickettsia* from clinical specimens.

**Chick embryo:** In the developing chick embryo 5–6 days old, *Rickettsia* spp. grow well in the yolk sac. The inoculated eggs are incubated at 35°C for most *Rickettsia* spp. and at 33°C for spotted group. The yolk sac is widely used as a source of *Rickettsia* for preparation of rickettsial antigens and vaccines. *Rickettsia* shows poor growth on chorioallantoic membrane.

**Laboratory animals:** Guinea pigs and mice are the commonly used laboratory animals for isolation of *Rickettsia* organisms from animal specimens.

### ► Other properties

**Susceptibility to physical and chemical agents:** The extracellular *Rickettsia* organisms are very delicate microorganisms. They are rapidly killed by heating at 56°C and also at room temperature. They are destroyed by usual strength of antiseptics, such as hypochlorite, 1% ethanol, 2% formaldehyde, 5% hydrogen peroxide, and 70% ethanol. They are preserved at –70°C or in a lyophilized state. They are preserved better in a special medium known as SPG medium containing sucrose, potassium phosphate, and glutamate, and also in the skimmed milk.

## Cell Wall Components and Antigenic Structure

*Rickettsia* possesses three different types of antigens as follows:

- 1. Group-specific antigen:** This is a soluble antigen present on surface of the organisms. This is extracted from rickettsial pathogens by repeated washings and centrifugations.
- 2. Species- or strain-specific antigen:** Species-specific or strain-specific antigen (e.g., scrub typhus) is present in the cell wall of the bacteria.
- 3. Alkali-stable polysaccharide antigen:** This is a surface antigen found in some species of *Rickettsia* and in some strains of *Proteus* species (*Proteus* OX19, OX2, and OXK). This sharing of antigen between *Rickettsia* and *Proteus* forms the basis of Weil–Felix test, which is employed for diagnosis of rickettsial infections by demonstration of antibodies using *Proteus* strains.

## Typhus Fever Group

Typhus refers to a group of infectious diseases that are caused by different rickettsial organisms. These are of three types.

- 1. Epidemic or louse-borne typhus** caused by *Rickettsia prowazekii*.
- 2. Relapsing louse-borne typhus** or Brill–Zinsser’s disease caused by *R. prowazekii*.
- 3. Endemic or flea-borne murine typhus** caused by *Rickettsia typhi*.

## *Rickettsia prowazekii*

*R. prowazekii* is the causative agent of epidemic typhus, also called louse-borne typhus. This condition is an acute febrile illness transmitted by human body louse *Pediculus humanus corporis*. *R. prowazekii* is named after the scientist Von Prowazek who died of the typhus fever while studying the disease. This typhus fever is an ancient disease and has been reported from all parts of the world. This disease was widely prevalent in Russia and in Eastern Europe. This disease was also responsible for Napoleon’s defeat in Russia in 1812. This was one of the three diseases responsible for misery and sufferings during the Irish famine of 1845–1850.

### Properties of the Bacteria

*R. prowazekii* organisms like other rickettsiae are small, Gram-negative, intracellular bacteria. They stain poorly with Gram stain, but stain best with Giemsa or Gimenez stain. Like other rickettsiae, they can grow in various tissue cultures (HeLa, Hep2, Detriot-6, mouse fibroblasts, and other continuous cells lines) and in yolk sac of embryonated egg.

### ► Other properties

Like other rickettsiae, they are susceptible to various physical and chemical agents, as described earlier.

### Pathogenesis and Immunity

*R. prowazekii* is an invasive bacterium, which characteristically multiplies in endothelial cells of the blood vessels, leading to vasculitis.

### ► Virulence factors

The capability to multiply inside the cell is important mechanism of the disease process caused by *R. prowazekii*. Adhesins are the most important virulent factor of rickettsia. These are outer membrane proteins, which facilitate the entry of rickettsiae into the host cells. Once inside the cells, they remain, multiply, and accumulate in large numbers before lysing the host cell.

### ► Pathogenesis of rickettsial infections

After inoculation from the infected sites, the rickettsiae reach the circulation, multiply, and cause rickettsemia. Rickettsiae are localized in the endothelial cells of small arterial capillary and venous vessels. At these sites, they multiply and cause endothelial cellular hyperplasia resulting in multiorgan vasculitis. The process may end in thrombosis and development of small nodules. Thrombosis of supplying blood vessels may cause gangrene of the extremities, ear lobes, nose, and genitalia. The vasculitis process also may result in increased vascular permeability with consequent edema, loss of blood volume, hypoalbuminemia, reduced osmotic pressure, and hypotension.



*Brill–Zinsser’s disease* is an example of a recrudescence case of typhus fever, which is observed in some people. The exact mechanism responsible for the recrudescence is not known.

## Clinical Syndromes

*R. prowazekii* causes epidemic typhus and recrudescence typhus.

### ► Epidemic typhus

Incubation period varies from as low as 2–3 days to an average period of 8 days. Epidemic typhus is characterized by high fever, severe headache, and chills. Appearance of a petechial or macular rash on the fourth or fifth day—first starting on the trunk and then spreading over to the extremities but without affecting the face, palms, and sole—is the characteristic feature of the condition. This rash is seen in nearly 40% of patients.

The patient if left untreated may become stuporous and delirious. The name typhus is derived from the word “*typhus*”, meaning cloud or smoke, which denotes cloudy state of consciousness in the disease process. Myocarditis and central nervous system (CNS) dysfunction are the noted complications of epidemic typhus. The disease is associated with mortality rate as high as 60% in old or debilitated persons.

### ► Recrudescence typhus

This condition was seen in some patients treated with antibiotics and has been apparently cured of the disease. *R. prowazekii* in such patients may persist in their body tissues, may reemerge, and cause a recurrence of typhus fever months, years, or even decades after antibiotic treatment. This condition is called recrudescence typhus. This disease was first noticed by Brill in 1988, and *R. prowazekii* were isolated from the areas in 1934. Hence, the disease is also called Brill–Zinsser disease.

Improper or incomplete antibiotic therapy, poor general health, and malnutrition are some of the risk factors that may predispose a person to recrudescence. The presentation of this disease is less severe and mortality is much lower than the epidemic typhus.

## Epidemiology

Epidemic typhus is a disease known since ancient times.

### ► Geographical distribution

Epidemic typhus is present in Central and South America, Africa (Ethiopia and Nigeria), Northern China, and in India.

### ► Habitat

*R. prowazekii* organisms are obligate intracellular parasites of humans and arthropod hosts.

### ► Reservoir, source, and transmission of infection

Humans are the primary reservoir of the epidemic typhus and are the sources of infection. The lice become infected with *R. prowazekii* after feeding on a person suffering from typhus fever or from Brill–Zinsser disease. Body louse,

*P. humanus corporis*, is the arthropod vector of epidemic typhus. Occasionally, the head louse *P. humanus capitis* may transmit the infection, but not the pubic louse. *R. prowazekii*, the causative agent of typhus, lives and multiplies in the alimentary tract of louse. The bacteria are excreted in feces within 3–5 days of infection. The lice are the only arthropod vector for rickettsial infection, which die after the infection (Fig. 48-1). Infection is transmitted to humans when a rickettsia-harboring louse bites a human during a blood meal.

Typically, lice defecate while feeding. When the host scratches the bite, the louse is crushed and the contaminated louse feces are inoculated into the minute lesions of the bite wound. From the infected sites the rickettsiae reach the circulation, multiply, and cause rickettsemia. Rarely, infection may also be transmitted through the conjunctiva or through inhalation of aerosols of dry louse feces.

The disease epidemic typhus is much more common among people living in crowded and unhygienic conditions, which facilitate spread of the body lice from one person to another. Such condition is commonly seen during wars, famines, and natural disasters as people live closely together.

## Laboratory Diagnosis

Diagnosis of rickettsial diseases, including epidemic typhus caused by *R. prowazekii*, is made by isolation of rickettsia in animal models or by serological tests.

### ► Culture

Rickettsiae are highly infectious pathogens; therefore, isolation of these pathogens from clinical specimens is carried out only in the laboratory equipped with high safety provision.

## Key Points

**Rickettsiae isolation** is carried out in male guinea pigs or mice by inoculating the clinical specimen intraperitoneally (Table 48-2). After inoculation, the animals are observed for 3–4 weeks. The response of animals to different rickettsial infections may vary:

- *R. prowazekii* infection produces fever without any testicular inflammation.
- Infection with *R. typhi*, *R. conori*, and *R. akari* develops fever and tunica reaction.
- Rickettsia causing rocky mountain spotted fever causes fever and scrotal necrosis in guinea pigs. The guinea pigs may even die of the disease. Smears from peritoneum, tunica, and spleen of the infected animals may be stained by Giemsa and Gimenez methods to detect these pathogens.

Rickettsiae may be isolated by growing in the cell culture. They grow better on Vero cells, in three and half days. The rickettsiae in these infected cell lines are identified by immunofluorescence, using group-specific and strain-specific monoclonal antibodies.

Isolation of rickettsia in the eggs or chick embryos is usually not followed for primary isolation of rickettsia from clinical specimens.

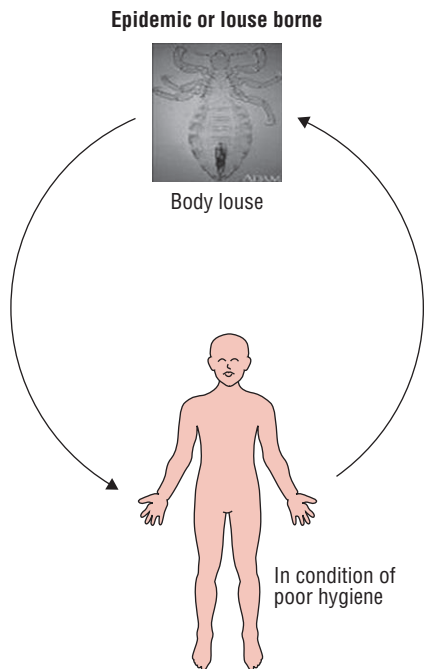

FIG. 48-1. Transmission of louse-borne typhus fever.

TABLE 48-2 Animal inoculation test

Rickettsial pathogen	Fever	Testicular inflammation or tunica reaction	Scrotal necrosis
<i>Rickettsia rickettsiae</i>	+	+	+
<i>Rickettsia typhi</i>	+	+	–
<i>Rickettsia conori</i>	+	+	–
<i>Rickettsia akari</i>	+	+	–
<i>Rickettsia prowazekii</i>	+	–	–

## ► Serodiagnosis

**Weil–Felix test:** This is a heterologous agglutination test used since long for diagnosis of rickettsial infections. The test detects antirickettsial antibodies that cross-react with O antigens of certain nonmotile strains of *Proteus*. In this test, nonmotile strains of *Proteus vulgaris* OX19 and OX2 and *Proteus mirabilis* OXK are used as antigens. The Weil–Felix test becomes positive 10–20 days after infection; sera from epidemic typhus strongly react with OX19 antigen and weakly agglutinate with OX2 antigen. They do not agglutinate with OXK antigen. Weil–Felix test is negative or weakly reactive in Brill–Zinsser disease. Reactions of Weil–Felix test in other rickettsial infections are summarized in Table 48-3.

Complement fixation test, indirect hemagglutination, indirect immunofluorescence, latex agglutination, and enzyme immunoassay are the other tests, which employ rickettsial antigens for demonstration of rickettsial antibodies for diagnosis of rickettsial infections including *R. prowazekii*. Of these methods, the indirect fluorescent antibody (IFA) test is the method of choice for diagnosis of epidemic typhus.

TABLE 48-3

Weil–Felix test in rickettsial diseases

Rickettsial diseases	Agglutination		
	OX19	OX2	OXK
Epidemic typhus	+++	+	–
Brill–Zinsser disease	+/-	–	–
Endemic typhus	+++	+/-	–
Spotted fever	++	++	–
Scrub typhus	–	–	+++

## Molecular Diagnosis

Polymerase chain reaction (PCR) is used to detect rickettsia in blood or tissue for early diagnosis of the condition.

## Treatment

Tetracycline and chloramphenicol are the drugs of choice for the treatment of epidemic typhus. Antibiotic therapy in combination with treatment of louse infestation of the human host is effective.

## Prevention and Control

Control of human lice population and sanitation are the effective measures to control epidemic typhus.

## Vaccines

A live vaccine containing attenuated “E” strain of *R. prowazekii* is available and is recommended for use in high-risk population.

## *Rickettsia typhi*

*R. typhi* is the causative agent of endemic or murine typhus.

## Properties of the Bacteria and Pathogenesis and Immunity

The morphology, cultural characteristics, and pathogenesis of the disease caused by *R. typhi* are similar to that caused by *R. prowazekii*. Infection with *R. typhi* can confer immunity to subsequent infection.

## Clinical Syndrome

The typhus fever caused by *R. typhi* is a milder disease than the epidemic typhus and has a shorter duration. The incubation period varies from 7 to 14 days. The condition has a sudden onset of symptoms with fever, headache, malaise, and myalgia. A rash develops on third to fifth day of infection in approximately

half of the infected patients. The rash is typically present on the chest and abdomen but may spread to palms and soles. Untreated course of the disease may last up to 3 weeks.

The endemic typhus differs from epidemic in being a mild illness of shorter duration, associated with few complications and case fatality rate less than 1%.

## Epidemiology

The murine typhus occurs in many parts of the world particularly in subtropical temperate coastal areas. The condition occurs mainly in sporadic forms. Rats (*Rattus rattus*), mice, and cats are the natural reservoirs of infection. Humans are the accidental hosts. Rat flea (*Xenopsylla cheopis*) or cat flea (*Ctenocephalides felis*) are the main vectors responsible for the transmission of disease. Endemic or flea-borne murine typhus is transmitted from rats to rats by a rat flea and accidentally to humans by the feces of infected fleas. Fleas become infected by feeding on the mice, cat, or other natural host. These infected fleas may subsequently transmit the disease to humans during act of biting. During bite, they transmit the disease by direct inoculation or indirect inoculation of the infected feces into the site of the bite. The cat flea *C. felis* may also transmit the disease. The infection can also be transmitted by inoculation or inhalation of aerosolized infectious specimens. The infection may also be transmitted by ingestion and food contaminated with infected rat urine or flea feces.

## Laboratory Diagnosis

Weil-Felix test used for diagnosis of epidemic typhus is also used for the diagnosis of endemic typhus. IFA test using *R. typhi*-specific antigen is used as a specific test for serodiagnosis of endemic typhus. A single titer of 1:128 or a fourfold rise in antibody titer in paired sera is diagnostic of the disease. *R. typhi* is differentiated from *R. prowazekii* by Neil Mooser reaction and by partial DNA homology.

### Key Points

#### Neil Mooser or tunica reaction

- Performed in an adult male guinea pig.
- The specimens (e.g., blood from the case of endemic typhus or *R. typhi* culture) are inoculated intraperitoneally.
- The animal is observed for the development of fever and a characteristic scrotal inflammation.
- In a positive test, the scrotum becomes enlarged and the testis cannot be pushed back into the layer of tunica vaginalis. This reaction is known as *Neil Mooser or tunica vaginalis reaction*.
- *R. typhi* shows positive Neil Mooser reaction.
- *R. prowazekii* shows negative Neil Mooser reaction (Table 48-2).

## Treatment

Tetracycline, doxycycline, and chloramphenicol are highly effective in the treatment of endemic typhus.

## Prevention and Control

Control of endemic typhus is difficult because the fleas causing the disease are distributed widely. The control measures are essentially based on the control of rodent population and flea population in the area endemic for disease.

## Spotted Fever Group

Spotted fever group of rickettsial diseases include:

- Rocky Mountain spotted fever caused by *Rickettsia rickettsiae*,
- Rickettsial pox caused by *R. akari*, and
- Boutonneuse fever (i.e., Kenya tick-bite fever, African tick typhus, Mediterranean spotted fever, Indian tick typhus, and Marseilles fever) caused by *R. conori*.

Rickettsiae of this group possess a common soluble group antigen. They also multiply in the nucleus as well as in the cytoplasm of the infected cells. All these species except *R. akari* are transmitted by ticks. A total of 12 species of rickettsiae have been associated with humans causing spotted fever and seven species have been isolated from arthropod vectors. *R. rickettsiae* is the most common species belonging to the spotted fever group and is responsible for Rocky Mountain spotted fever.

## *Rickettsia rickettsiae*

*R. rickettsiae* causes Rocky Mountain spotted fever, the most serious type of spotted fever. Rocky Mountain spotted fever was the first among the spotted fever group to be described. This disease was earlier called as Mediterranean disease and later boutonneuse fever by Connor who described this condition for the first time in 1910. Megaw in 1917 first described this disease in the foothills of Himalaya in India.

## Properties of the Bacteria

Morphology, culture, biochemical reactions, and other properties of *R. rickettsiae* are similar to those of other rickettsial pathogens. They are small intracellular bacteria, which multiply in the cytoplasm of the infected cells. They stain poorly with Gram stain, but stain well with Giemsa or Gimenez stain.

## Pathogenesis and Immunity

*R. rickettsiae* like other rickettsiae multiply within the endothelial cells of the small blood vessels and invade the blood streams. Subsequently, they cause vasculitis and vascular lesions, which are found in almost all organs but are commonly found in the skin and in the adrenal glands, liver, heart, and CNS. The condition progresses to hypoalbuminemia, hyponatremia, and hypovolemia due to loss of plasma into the tissues.

## Clinical Syndrome

*R. rickettsiae* cause Rocky Mountain spotted fever.

### ► Rocky mountain spotted fever

Incubation period is 7 days. The condition is characterized by development of fever, severe headache, chills, and myalgia. A rash may develop after three or more days and typically appears initially on wrist, ankles, and palms and soles and then spreads to the trunk. The rash is maculopapular early in the disease but may later become petechial and hemorrhagic.

This is a serious disease associated with many complications, such as respiratory failure, encephalitis, and renal failure. The patient may die within 5 days of onset of symptoms. The overall mortality rate is nearly 4% despite effective antibiotic therapy. The deficiency of enzyme glucose-6-phosphate dehydrogenase (G6PD) is usually associated with more severity of infection.

## Epidemiology

### ► Geographical distribution

Rocky Mountain spotted fever is distributed in southern Canada, Central America, Mexico, and parts of South America. *R. rickettsiae*, causing the condition, is the most common rickettsial pathogen in the United States.

### ► Habitat

*R. rickettsiae* is an intracellular pathogen of endothelial cells and blood vessels of humans. The bacteria are also found in ticks.

### ► Reservoir, source, and transmission of infection

Ticks are the natural hosts, reservoirs, and vectors of *R. rickettsiae*. Different tick hosts are associated with the infection in different parts of the world. These vectors include the wood tick (*Dermacentor andersoni*) in the western United States and western Canada, the American dog tick (*Dermacentor variabilis*) in the eastern Canada and eastern United States, and Lone star tick (*Amblyomma americanum*) in the southwestern United States. Rickettsia multiplies in these ticks and is transmitted transovarially to the next generation (Fig. 48-2).

*R. rickettsiae* is transmitted to humans through saliva during the bite by a tick. It usually takes 6 hours of attachment and feeding before rickettsiae are transmitted to the host. Infection can also be transmitted occasionally by scratching and rubbing infectious tick feces into the abraded skin.

## Laboratory Diagnosis

### ► Specimens

These include skin biopsy for antigen detection and serum for serodiagnosis.

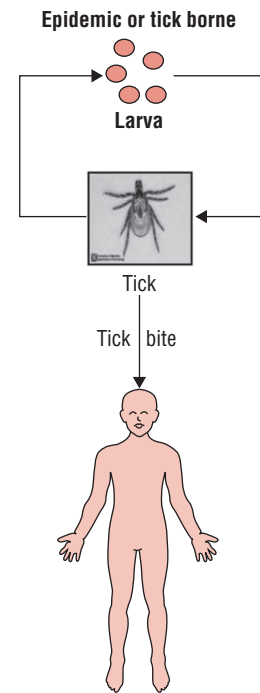

FIG. 48-2. Transmission of tick-borne typhus fever.

### ► Culture

*R. rickettsiae* can be isolated in embryonated egg or tissue cultures, but cultures are rarely attempted because of associated risk of infection.

### ► Direct detection of rickettsial antigen

Direct detection of *R. rickettsiae* in skin biopsy specimens of the rash from infected patients by direct fluorescent antibody test using the specific antirickettsial antibodies is a rapid and specific method for confirming diagnosis of Rocky Mountain spotted fever. This test is recommended for its use prior to therapy or within the first 48 hours after the antibiotic therapy.

### ► Serodiagnosis

Definite diagnosis of Rocky Mountain spotted fever is made by employing serological tests that detect *R. rickettsiae* immunoglobulin G (IgG) antibodies. IFA and enzyme linked immunosorbent assay (ELISA) are new serological tests that are used for early diagnosis of the condition.

The IFA is most commonly used test. This test uses group-specific heat-labile proteins and the LPS antigens of scrub typhus group. Therefore, the test is not species specific. The IFA is 95–100% sensitive and 100% specific. Demonstration of a fourfold rise in antibody titers between acute and convalescent sera or demonstration of antibody titre of 1:64 or more in a single serum is diagnostic of the disease. These antibodies are detected in the serum 2–3 weeks after the onset of the disease and remain in the serum after a very long period of time.

## Molecular Diagnosis

PCR has been used to detect *R. rickettsiae* DNA in the skin biopsy specimens of the rash with good sensitivity and high specificity.

## Treatment

Tetracyclines, chloramphenicol, and fluoroquinolones, such as ciprofloxacin are effective against *R. rickettsiae*.

## Prevention and Control

The use of protective clothing and insect repellents and avoidance of tick-infested areas are preventive measures against *R. rickettsiae* infection. No vaccine is available against the Rocky Mountain spotted fever.

## Other Rickettsial Species in the Spotted Fever Group

Six other rickettsial species in the spotted fever group have been associated with human disease. These include tick-borne diseases, such as boutonneuse fever caused by *R. conori*, Australian tick typhus caused by *Rickettsia australis*, and Siberian tick typhus caused by *Rickettsia siberica*. All these rickettsial pathogens are maintained in wild animals and ixodid ticks. Humans are the accidental hosts. The clinical diseases produced by these rickettsiae are similar to the Rocky Mountain spotted fever but are relatively milder.

## *Rickettsia akari*

Rickettsial pox caused by *R. akari* is prevalent worldwide. It has been reported from Russia, South Africa, and Korea. Common house mouse (*Mus musculus*) is the natural reservoir. *R. akari* is transmitted from mouse to mouse by the bite of the mouse mite (*Liponyssoides sanguineus*). The infection in the mite is transmitted to the progeny transovarially (Fig. 48-3).

The incubation period is 7 days. The condition manifests by development of papule at the site of the bite by the mite.

Subsequently, the papule progresses to an ulcer and then it leads to the formation of eschar. This is followed by development of fever, headache, malaise, and myalgia in 3–10 days. A generalized papular vesicular rash usually appears 3–4 days after the emergence of fever. The illness lasts for a short duration of 10–14 days, after which recovery occurs. Complete healing of rash occurs within 2–3 weeks without treatment.

The rickettsial pox is clinically is a mild form of infection. Like other rickettsial infections, diagnosis of the condition is clinically supported by serology. This disease is differentiated from other rickettsial infections by:

- The presence of an *eschar* at the site of bite of mouse mite,
- The presence of a *vesicular pustular eruption*, and
- A *negative Weil–Felix reaction*. Rodents are the natural host of the mite transmitting rickettsial pox in different parts of the world. Treatment with doxycycline or chloramphenicol is highly effective for rickettsial pox infections.

The epidemiology of rickettsial species causing human diseases is summarized in Table 48-4.

## Genus *Orientia*

Genus *Orientia* contains *Orientia tsutsugamushi*, the causative agent of scrub typhus.

## *Orientia tsutsugamushi*

*O. tsutsugamushi*, formerly known as *R. tsutsugamushi*, is the causative agent of scrub typhus. The condition is transmitted to humans by the mite *Leptotrombidium akamushi* and also possibly by *Leptotrombidium deliense*. Four stages of development usually take place in the life cycle of the mite. Of these stages, only larval stage (*chigger*) is infectious to humans and other mammals because these stages require blood meal for further development.

*O. tsutsugamushi* shows a remarkable antigenic heterogeneity. Three major serotypes are recognized. These are Kart, Gili, and Kata types. The organism is transmitted to humans by chiggers that live and reproduce in the soil and in the scrub vegetation.

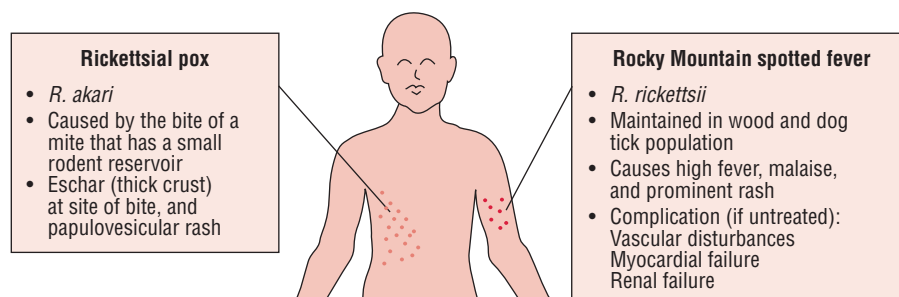

FIG. 48-3. Comparison of rickettsial pox and Rocky Mountain spotted fever.

TABLE 48-4

Epidemiology of *Rickettsia* species causing human diseases

Species	Vector	Reservoir	Disease
<i>Rickettsia prowazekii</i>	Louse	Humans	Epidemic typhus and Brill-Zinsser disease
<i>Rickettsia typhi</i>	Rat flea	Rat	Endemic typhus
<i>Rickettsia rickettsiae</i>	Tick	Ticks, wild rodents	Rocky Mountain spotted fever
<i>Rickettsia akari</i>	Gamasid mite	Mouse	Rickettsial pox
<i>Rickettsia conori</i>	Tick	Rodents	Boutonneuse fever
<i>Rickettsia australis</i>	Tick	Unknown	Queensland tick typhus

Scrub typhus is restricted in its geographical distribution. The condition is present in the western Pacific regions, Australia, and Eastern Asia. Once the mice are infected, they act as reservoir of *O. tsutsugamushi*. Rats, mice, and larger mammals are the usual hosts. Humans are the accidental hosts. The mites feed on the blood of animals only once during the cycle of development, hence are not believed to be an important reservoir for human diseases. The infection is transmitted from rats to the progeny by transovarial transmission.

Scrub typhus is a mild and self-limiting disease, but if untreated it has a fatality of 7%. The incubation period on an average varies from 10 to 12 days. The condition manifests with severe headache, fever, myalgia, and rash. The maculopapular rash develops initially on the trunk and later on the limbs, and is present in nearly 50% of the patients. In untreated patients, fever disappears after 2–3 weeks. Splenomegaly, CNS complications, generalized lymphadenopathy, and heart failure are the complications of this condition.

Tetracyclines, doxycycline, or chloramphenicol are highly effective in treatment of scrub typhus. An effective vaccine is not available. Use of insect repellants and wearing protective clothings to avoid exposure to chiggers prevent the disease.

## Genus *Ehrlichia*

*Ehrlichia* are small, Gram-negative, obligate, intracellular bacilli that parasitize mononuclear and granulocytic phagocytes but not erythrocytes. The bacteria multiply in the cytoplasm of infected phagocytic cell as mulberry-like clusters called *morula*. The genus *Ehrlichia* consists of three species that cause infections in human. These are (a) *Ehrlichia sennetsu* causing sennetsu fever, (b) *Ehrlichia chaffeensis* causing monocytic ehrlichiosis, and (c) *Ehrlichia phagocytophila* causing human granulocytic ehrlichiosis.

The genus *Ehrlichia* is named after the scientist Paul Ehrlich. The first case of *Ehrlichia* infection in humans was reported in Japan in 1954. The cases resembled glandular fever with the serum positive for antibodies against the agents of canine ehrlichiosis. The causative agent isolated from the cases was named *E. sennetsu*. *Sennetsu* is a Japanese word, meaning glandular fever.

## Properties of the Bacteria

*Ehrlichia* are small intracellular bacteria. They stain poorly with Gram stain, but stain well with Giemsa or Gimenez stain. They multiply in phagosomes of infected cells. Culture and other characteristics are same as described for rickettsia.

## Pathogenesis and Immunity

*Ehrlichia* are intracellular pathogens. Intracellular location of these pathogens protects them from immune response of the host. Inside the cell, they are able to prevent fusion of phagosome with lysosome of monocytes or granulocytes, hence are not lysed by the host's antibody response.

## Clinical Syndromes

*Ehrlichia* species cause three clinical syndromes: (a) sennetsu fever, (b) human monocytic ehrlichiosis, and (c) human granulocytic ehrlichiosis.

### ► Sennetsu fever

Sennetsu fever is caused by *E. sennetsu*. The condition presents typically as an acute febrile illness and resembles glandular fever. Cervical lymphadenopathy, atypical lymphocytosis, and increase in number of peripheral mononuclear cells are the typical manifestations of the disease.

### ► Human monocytic ehrlichiosis

This condition is caused by *E. chaffeensis*, which infects mostly monocytes. Human diseases are associated with headache, malaise, and myalgia after 1–3 weeks of tick bite. Leukopenia, thrombocytopenia, and elevated liver enzymes are other manifestations. Rash is found in only 20% of the patients. Mortality due to condition is less than 5% and is seen primarily in patients with immunocompromised status and also in elderly patients.

### ► Human granulocytic ehrlichiosis

This condition is caused by *E. phagocytophila* as well as *Ehrlichia ewingii*, which infect mostly granulocytes. This condition is characterized by a febrile illness having similar manifestations to that of human monocytic ehrlichiosis. The condition is associated with leukopenia and thrombocytopenia similar to that in human monocytic ehrlichiosis.

## Epidemiology

### ► Geographical distribution

Sennetsu fever is a tick-borne disease restricted to Japan. Human monocytic ehrlichiosis is distributed mainly in the southeastern, mid-Atlantic, and south-central parts of the United States. There are areas in which lone star tick (*Amblyomma americanum*) are found in large numbers. Human granulocytic ehrlichiosis is distributed in the Northeast and

Central Atlantic states and in midwestern states of the United States and also in the Europe.

► **Habitat**

Like other rickettsia, *Ehrlichia* is found as obligate intracellular parasite in infected hosts.

► **Reservoir, source, and transmission of infection**

Ehrlichiosis are tick-borne diseases. Ticks are the vectors for all *Ehrlichia* species causing diseases in humans and animals. White tick deer and domestic dogs are reservoirs for *E. chaffeensis*, and the bacteria are transmitted by the lone star tick (*A. americanum*). Dogs are the vectors for *E. ewingii*. The lone star tick also transmits the infection. Small mammals, such as white-footed mouse, chipmunks, and whorls are the reservoirs for *E. phagocytophila*. *Ixodes* species including *Ixodes capillaris*, *Ixodes ricinus*, and *Ixodes pacificus* are the vectors for the pathogen.

Reservoirs are not known for sennetsu fever. It is an exception, which is transmitted by ingestion of raw fish infected with flukes but not by ticks. The epidemiology of *Ehrlichia* species causing human diseases is summarized in Table 48-5.

**Laboratory Diagnosis**

Laboratory diagnosis depends on demonstration of the pathogen by microscopy and isolation by culture.

► **Microscopy**

Human ehrlichiosis may be diagnosed by microscopy. Giemsa-stained smear of blood films shows morulae, the intracellular form of the bacteria and is the diagnostic of the disease. However, this method has low sensitivity. Morulae are detected only in less than 10% of patients with human monocytic ehrlichiosis and in 20–80% of patients with human granulocytic ehrlichiosis.

► **Culture**

Isolation of *Ehrlichia* by culture is frequently used for diagnosis of ehrlichiosis.

► **Serodiagnosis**

The IFA is used to demonstrate specific antibodies in the serum by using *Ehrlichia* antigen prepared from the cell culture. The limitations of serological tests are that they cannot differentiate between *E. ewingii* and *E. chaffeensis* infections because they are antigenically closely related.



**Molecular Diagnosis**  
Molecular methods, such as DNA probes and PCR are used for specific diagnosis of *E. ewingii* and *E. chaffeensis* infections.

**Treatment**

Doxycycline is the drug of choice for treatment of human ehrlichiosis. Chloramphenicol and fluoroquinolones are not that effective.

**Prevention and Control**

Use of insect repellants, wearing protective clothings, etc., are the preventive measures against bites by ticks. Effective vaccine is not available.

**Genus *Coxiella***

The genus *Coxiella* was originally classified with rickettsia because the bacteria showed features of a rickettsial pathogen. Like rickettsiae they (a) stain poorly with Gram staining, (b) multiply intracellularly in eukaryotic cells, and (c) are transmitted by arthropods. *Coxiella* differs from rickettsiae by the following features:

1. They are not transmitted by arthropod vectors but are transmitted by inhalation or ingestion.
2. They show relatively more resistance to actions of dry heat.

The genus *Coxiella* now has been separated from rickettsiae and is placed in the group Protobacteria along with other genera, such as *Legionella* and *Francisella*. This is because *Coxiella* was found to be more closely related to these two genera. The genus *Coxiella* includes the species *C. burnetii*, which causes Q fever.

TABLE 48-5

**Epidemiology of *Ehrlichia* species causing human diseases**

Species	Vector	Reservoir	Disease
<i>Ehrlichia sennetsu</i>	No tick vector; ingestion of raw fish infected with flukes	Unknown	Sennetsu fever
<i>Ehrlichia chaffeensis</i>	Lone star tick	White tick deer and domestic dogs	Monocytic ehrlichiosis
<i>Ehrlichia phagocytophila</i>	<i>Ixodes</i> ticks	Small mammals (white-footed mouse, schipmunks, and whorls)	Human granulocytic ehrlichiosis
<i>Ehrlichia ewingii</i>	<i>Amblyomma</i> ticks	Unknown	Granulocytic ehrlichiosis

## *Coxiella burnetii*

*C. burnetii* is the causative agent of Q fever, a zoonotic disease transmitted from animals to humans. Q fever was first studied in an experimental infection of guinea pigs by inoculation of blood from patients suffering from typhus-like fever to guinea pigs by Derrick in 1935. As the etiological agent of the disease was not known, the condition was referred to as query or Q fever. Subsequently, Burnett identified the causative agent as a rickettsial, after which the pathogen was named as *Rickettsia burnetii*. Cox in the United States demonstrated the agent in ticks and named it *Rickettsia diaphorica*. Later, both the rickettsial strains were shown to be identical. The organism is now named as *C. burnetii* and reclassified in the group Protobacteria.

### Properties of the Bacteria

#### ► Morphology

*C. burnetii* shows following features:

- *C. burnetii* is an obligate intracellular bacterium.
- It is pleomorphic and measures  $1 \times 0.3 \mu\text{m}$  in size.
- The bacterium is Gram negative, but stains poorly with Gram staining. These bacteria like other rickettsiae stain best with Giemsa or Gimenez stains.

#### ► Culture

*C. burnetii* primarily infects the monocytic macrophage cell. It multiplies in phagolysosomes of the infected cell. It grows well in various cell lines and in the yolk sac.

#### ► Other properties

**Susceptibility to physical and chemical agents:** *Coxiella* are most resistant pathogens to heat and dryness. They are not completely killed at  $60^\circ\text{C}$  or by 1% phenol in 60 minutes. Hence, pasteurization by holding method is not effective method for killing *C. burnetii*, but the flash method is effective. The bacteria survive for a month in meat and for a year or more in dried feces at  $4^\circ\text{C}$ .

### Cell Wall Components and Antigenic Structure

Characteristically, *Coxiella* exists antigenically in two forms: (a) phase 1 antigen and (b) phase 2 antigen.

**Phase 1 antigen:** It is a cell wall LPS antigen with a complex carbohydrate structure. This antigen usually prevents interaction of antibodies with surface protein. *Coxiella* in phase 1 antigen is highly infectious. Phase 1 is highly immunogenic and elicits a strong antibody response to both 1 and 2 antigens.

**Phase 2 antigen:** This occurs by following repeated passage in yolk sac in which the LPS is modified by exposing the surface proteins to antibodies. In this phase, the surface proteins act with host antibodies. *Coxiella* occurring in phase 2 is a less infective form of the bacterium.

*C. burnetii* either in phase 1 or phase 2 do not show any antigenic sharing with rickettsia or *Proteus* bacillus antigen. Therefore, Weil–Felix test is not useful for detection of *C. burnetii* infection. The antibodies in serum of Q fever do not react with *Proteus* antigens used in the Weil–Felix test.

Acute stage of Q fever is characterized by the presence of antibody titers against phase 2 antigen, whereas chronic disease is characterized by presence of antibodies against both phase 1 and phase 2 antigens. These high titers of antibodies appear to be responsible for pathological changes in various organs during the disease. The cell-mediated immunity is associated with recovery from the clinical illness.

### Pathogenesis and Immunity

*C. burnetii* causes infection by penetrating through abraded skin, mucosa, lung, or intestinal tract. They typically grow and multiply in acidic environment of fused phagosome and lysosome. Phase 1 form of *C. burnetii* is protected from the action of antibodies.

*Coxiella* affects lungs and heart valves and has also been found in macrophages in the lungs and in vegetations of heart valves. The bacteria also cause granulomatous changes in reticuloendothelial organs, such as liver, spleen, etc. Host-mediated pathogenic mechanisms are believed to play an important role in the pathogenesis of Q fever.

### Clinical Syndrome

*C. burnetii* causes Q fever, which can occur in acute or chronic forms.

#### ► Q fever

Incubation period is 20 days. The acute stage of Q fever manifests as sudden onset of severe headache, high fever, chills, and myalgia. The bacteria produce a respiratory infection mimicking the atypical pneumonia. They also cause hepatosplenomegaly, which is found in approximately half of the patients.

The chronic form of Q fever has a long incubation period varying from months to years. Onset of the disease is usually insidious. Subacute endocarditis on a previously damaged heart valve or a prosthetic heart valve is the most common manifestation of the condition. Hepatitis and meningoencephalitis are the other manifestations of the disease.

Uncomplicated acute disease is a self-limiting disease, which lasts for 1–2 years. Complications in chronic diseases may increase mortality rate to as high as 30–60%.

### Epidemiology

Q fever like other human rickettsial infection is a zoonotic disease transmitted from infected animals to humans.

#### ► Geographical distribution

*C. burnetii* infection is common in domestic livestock in many parts of the world. *C. burnetii* infection in birds and animals has been documented by serological studies. Sporadic cases of human infections have been reported.



## ► Habitat

*C. burnetii* are intracellular pathogens in infected livestock and also in humans.

## ► Reservoir, source, and transmission of infection

Q fever is a zoonosis distributed worldwide. Farm animals, such as sheep, cattle, and goats as well as cats, dogs, and rabbits are primary reservoirs of infection. Ixodid ticks are responsible for transmitting the disease to rodents and domestic animals and for maintaining infection in these animals.

*C. burnetii* infection in ticks is transmitted transovarially to progeny. *Coxiella* are excreted in the feces and survive in dried feces over a long period of time. In infected animals, *Coxiella* are excreted in the milk and particularly in their products of conception during parturition of these animals. These bacteria contaminate surroundings of the animals, where they remain as potential source of infection to humans for months.

### Key Points

- Ticks do not play any role in the transmission of Q fever from infected animals to humans.
- Humans acquire diseases by inhalation of infected aerosols.
- They also possibly acquire the disease from consumption of milk infected with *C. burnetii*.
- Person-to-person transmission does not occur.

## Laboratory Diagnosis

*C. burnetii* can be diagnosed by isolation of the bacteria from clinical specimens in guinea pigs, mice, and developing chick embryo. But isolation of the bacteria by these methods is not attempted, because these procedures are biohazardous and are also not required.

## ► Serodiagnosis

Serology is the mainstay of diagnosis of Q fever. Serological tests include immunofluorescence test, complement fixation test, and ELISA. All these tests detect IgM or IgG antibodies by using phase 1 and 2 antigens. Serodiagnosis of acute Q fever is made by demonstration of (a) IgG titer of 1:200 or more, or IgM titer of 1:50 or more in a single serum specimen, or (b) a fourfold rise of antibody titer between acute and convalescent sera. The IgG antibodies are present in serum for more than 1 year in 90% of patients, whereas IgM antibodies are present only for 2 weeks and become negative after 2 weeks.

Serodiagnosis of chronic Q fever is made by demonstration of high antibody titer against phase 1 and 2 antigens. Antibodies against phase 1 antigen are always higher. Weil–Felix test is not used for diagnosis of Q fever.



### Molecular Diagnosis

PCR is currently evaluated to detect *C. burnetii* in clinical specimens; however, it still remains to be a research tool and is not widely used in the diagnosis.

## Treatment

Treatment with tetracyclines, such as doxycycline, is effective for acute Q fever. A combination of a tetracycline and cotrimoxazole or rifampicin for a prolonged period is essential for treatment of subacute endocarditis and other chronic diseases caused by *C. burnetii*.

## Prevention and Control

Preventive measures for Q fever include:

- Wearing protective clothing (mask, gloves) while handling carcasses and animal hides,
- Pasteurization of milk by flash method instead of holder method, and
- Isolation of facilities for parturition of animals.



### CASE STUDY

A 30-year-old farmer from Himachal Pradesh attended the Medicine OPD with symptoms of fever, headache, and appearance of rashes over surface of the body. He gave the history that the rash appeared on fifth day of the fever, which first appeared on trunk and then spread to the extremities. On examination, the rashes were found to be maculopapular. These rashes were not found on the face, palm, and sole. Serum was sent for febrile agglutination tests. Widal and standard agglutination test for brucellosis were negative. Paul–Bunnell test was also negative. ELISA for HIV was also negative. Weil–Felix test showed agglutination with OX19 and OX2 but not with OXK.

- What is the most probable diagnosis?
- What are the other tests that can be carried out to diagnose the condition?
- How will you treat the condition?
- Is this condition found in India?

# Chlamydia and Chlamydophila

## Introduction

The taxonomy of *Chlamydia* has undergone extensive revision recently on the basis of genomic studies of this microorganism. *Chlamydia* is included in the order Chlamydiales, which contains one family Chlamydiaceae. Previously, the family consisted of a single genus *Chlamydia* with four species (*Chlamydia trachomatis*, *Chlamydia psittaci*, *Chlamydia pneumoniae*, and *Chlamydia pecorum*).

Now the family has been reclassified into two genera: *Chlamydia* and *Chlamydophila*. The species *C. trachomatis* is included in the genus *Chlamydia*, whereas *C. psittaci* and *C. pneumoniae* are included in the new genus *Chlamydophila*. In addition, there are other species that are uncommon human pathogens, which have been placed in either of the two genera.

## Chlamydia

Chlamydiae are obligate intracellular parasites of humans and animals with marked affinity for the squamous epithelial cells of the gastrointestinal and respiratory tracts. Species causing human infections are summarized in Table 49-1.

The chlamydiae were once considered viruses due to their filterability through 0.45  $\mu\text{m}$  filter and due to their failure to grow in cell-free media. Earlier they were named *Psittacosis lymphogranuloma trachoma* (PLT) viruses or PLT agents. However, the *Chlamydia* shows the following properties of bacteria by which they differ from viruses:

1. They contain both DNA and RNA.
2. They possess cell wall as that of Gram-negative bacteria.
3. They contain prokaryotic ribosomes.

4. They multiply by binary fission.
5. They produce and synthesize their own nucleic acid, lipids, and proteins.
6. They are susceptible to a wide range of antibiotics, such as tetracyclines, erythromycin, macrolides, and rifampicin.

## General Properties

The chlamydiae occur in two morphologically distinct forms: elementary body and reticulate body.

**Elementary body:** The elementary body (EB) is a small, extracellular, infective form. It is a round particle measuring 300–400 nm in size. The cell wall possesses a rigid trilaminar structure as seen in the cell walls of Gram-negative bacteria. These bacteria lack peptidoglycan layer found in other bacteria. However, their outer membrane proteins due to the presence of extensive cross-linked protein of the outer membrane confer rigidity to the cell wall. The chlamydiae do not multiply in the EB form, but are infectious. They cause infections by binding to receptors on the epithelial cells and stimulate uptake of the bacteria by infiltration.

**Reticulate body:** The reticulate body (RB) is a large, noninfectious form of *Chlamydia*. It measures 500–1000 nm in size. It is metabolically active and replicating form of *Chlamydia*. The extensive cross-linked proteins that confer rigidity are absent in the RBs. Hence, this form of *Chlamydia* is osmotically fragile and friable. This form, however, is protected by its intracellular location.

A genus-specific lipopolysaccharide (LPS) is present in the cell wall of *Chlamydia*. This LPS can be detected by a complement fixation test (CFT) and species-specific and strain-specific outer membrane protein.

## Growth and Multiplication

The *Chlamydia* multiplies by a characteristic growth cycle that takes place within susceptible host cells (Fig. 49-1). Elementary bodies are the infective form, which initiate the cycle. The infection is initiated by the attachment of the EB to the microvilli of susceptible epithelial cells followed by penetration into the host cell. Inside the host cells, EB remains within the cytoplasmic phagosomes in which EBs begin to multiply. The fusion of EB containing phagosome with cell wall lysosome is prevented; thus intracellular killing of EB is inhibited. This phagolysosomal fusion is usually prevented in the host cells with the intact outer membrane.

TABLE 49-1

Human infections caused by *Chlamydia* species

Bacteria	Diseases
<i>Chlamydia trachomatis</i>	Lymphogranuloma venereum, ocular lymphogranuloma venereum, trachoma, adult inclusion conjunctivitis, neonatal conjunctivitis, infant pneumonia, and urogenital infections
<i>Chlamydophila pneumoniae</i>	Pharyngitis, sinusitis, bronchitis, and pneumonia
<i>Chlamydophila psittaci</i>	Psittacosis

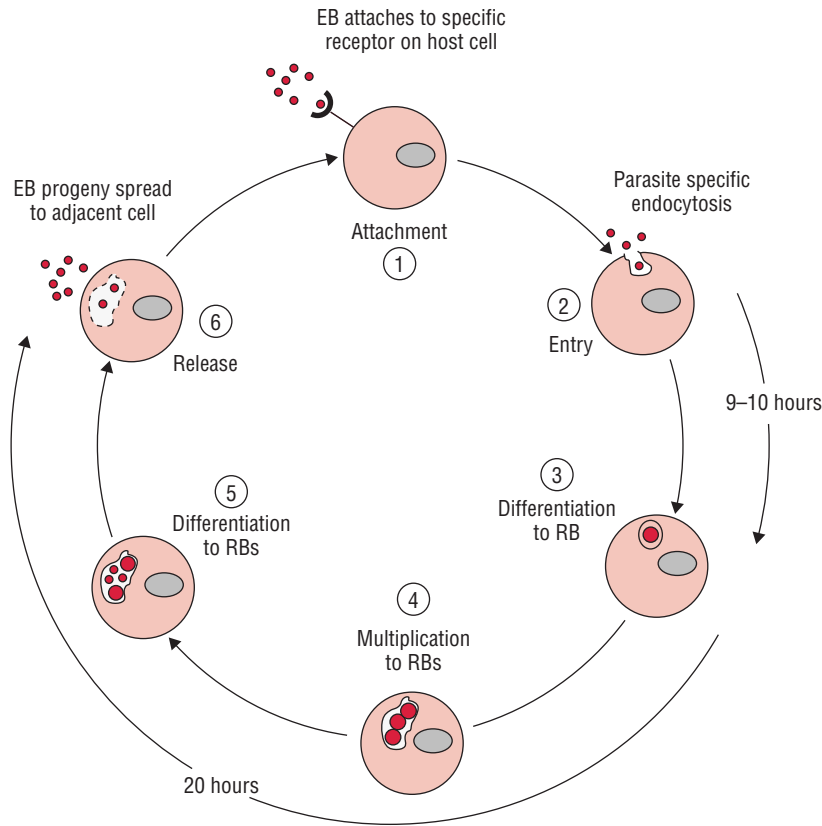

FIG. 49-1. Life cycle of *Chlamydia*. EB: elementary body; RB: reticulate body.

TABLE 49-2

Differential features of *Chlamydia* species causing human diseases

Properties	<i>Chlamydia trachomatis</i>	<i>Chlamydia pneumoniae</i>	<i>Chlamydia psittaci</i>
Elementary body	Round; narrow periplasmic space	Pear-shaped; large periplasmic space	Round; narrow periplasmic space
Inclusion body	Single inclusion per cell	Multiple, uniform inclusions per cell	Multiple, variable inclusions per cell
Plasmid DNA	Yes	No	Yes
Iodine staining	Stains inclusion body	Does not stain	Does not stain

Within 6–8 hours after entering the cell, the EBs within the phagosome are transformed to large, metabolically active RBs. These RBs synthesize their own proteins and nucleic acids but lack the ability to produce their own high-energy phosphate compound. The chlamydiae are called energy parasites because of this deficiency. Some strains of *Chlamydia* also depend on the host for the requirement of their amino acid.

The RBs multiply by binary fission, which continues for next 18–24 hours. The developing phagosome with accumulated reticulated bodies within the host cell is called the inclusion body. The mature inclusion body contains nearly 100–500 EBs, which can be readily demonstrated by various staining procedures. Ultimately, the host cell ruptures, releasing the EBs.

In *C. trachomatis* infection, the release of EBs occurs within 70–96 hours. The release of the host cell is marked by the presence of a scar. The release of EBs in *C. psittaci* infection occurs within 48 hours by lysis of the host cell leading to severe damage of the infected host cell.

Chlamydiae during the active growth express the *Chlamydia*-specific LPSs on the cell surface of the infected host cell. These LPSs expressed on the outer surface of the cell are highly antigenic and induce immunological and inflammatory responses.

The properties that differentiate the three *Chlamydia* species are summarized in Table 49-2. These species differ in their (a) growth characteristics, (b) antigens, (c) nucleic acid profile, (d) plasmids, and (e) nature of the inclusion body.

***Chlamydia trachomatis***

*C. trachomatis* is a strict human pathogen.

**Properties of the Bacteria**

► **Morphology**

*C. trachomatis* are Gram-negative bacteria. However, they can be stained better by Giemsa, Castaneda, Machiavello, or

Gimenez stains. *C. trachomatis* like other chlamydiae occurs in two morphologically distinct forms: elementary body and reticulate body.

EB is an extracellular infectious particle. It is small and spherical and measures 800–1200 nm in diameter. These inclusion bodies in the infected cells, such as conjunctiva, urethra, and corneal smears can be demonstrated after staining with Giemsa, Castaneda, or Machiavello methods. These inclusion bodies are large-sized particles, which can be easily demonstrated under light microscope. These bodies consist of glycogen matrix, hence are demonstrated on staining with Lugol's iodine.

Reticulate body is metabolically active and replicating form of *Chlamydia*.

### ► Culture

*C. trachomatis* grows better in various tissue cultures, using nonreplicating stationary-phase cells. The bacteria can grow in a few cell lines, such as HeLa-229, McCoy, BHK-21, and buffalo green monkey kidney cells. McCoy and HeLa cells are frequently used for the isolation of the bacteria.

*C. trachomatis* can be grown by inoculation into embryonated eggs and also by experimental infection in animals, such as mice. *Chlamydia* spp. grow in yolk sac of 6–8 days old chick embryo. The growth of chlamydia is demonstrated by the presence of elementary and inclusion bodies as well as group-specific complement-fixing antigen in the yolk sac.

*C. trachomatis* strains differ in their infectivity (L1, L2, and L3) and cause infection in mice when injected intracellularly.

### ► Other properties

**Susceptibility to physical and chemical agents:** Chlamydiae are heat-labile bacteria and are readily killed within minutes by heating at 56°C. They are susceptible to ethanol, ether, phenol, formalin, iodine, potassium permanganate, sodium hypochlorite, silver nitrite, and chlorite. They remain fully viable for several days at 4°C. Moreover, they can be preserved at –70°C or in liquid nitrogen for a long period.

## Cell Wall Components and Antigenic Structure

Chlamydiae possess three types of major antigens: (a) genus-specific antigens, (b) species-specific antigens, and (c) serotype-specific antigen.

### ► Genus-specific antigen

This is a heat-stable, complement-fixing, and genus-specific antigen. It is an LPS–protein complex resembling the LPS of Gram-negative bacilli. It is present in EBs and RBs. The antigen can be extracted by ether, chloroform, or methanol. The antigen is identified by CFT.

### ► Species-specific antigen

This antigen is present at the envelope surface and is species specific. This antigen is present in all the strains of *Chlamydia*.

### ► Serotype-specific antigen

This antigen is present only in a few species of chlamydiae. They are located in the major outer membrane proteins (MOMPs) and are useful for intraspecies typing of *Chlamydia* species.

### ► Typing of species

On the basis of these antigens, *Chlamydia* species are classified into various serovars and serologic variants. *C. trachomatis* has been subdivided into three biological variants known as biovars: (a) trachoma biovar causing trachoma and inclusion conjunctivitis (TRIC), (b) lymphogranuloma venereum (LGV) biovar causing LGV, and (c) serovars causing mouse pneumonitis. These biovars on the basis of antigenic differences in the MOMPs have been further classified into 20 serotypes. The trachoma biovar consists of 13 serotypes (A, B, Ba, C, D, Da, E, F, G, H, I, Ia, J, Ja and K). The LGV biovar consists of only five serotypes (L1, L2, L2a, L2b, and L3).

## Pathogenesis and Immunity

*C. trachomatis* is an obligate intracellular bacterium that causes diseases of many systems in humans.

### ► Virulence factors

The ability to multiply intracellularly in the infected cell is the key mechanism of virulence of *C. trachomatis*. The bacteria prevent fusion of phagolysosome with cellular liposomes, thereby preventing intracellular killing of the bacteria by the host cell. Repeated infections caused by *C. trachomatis* contribute to pathology seen in the infected eye in trachoma.

### ► Pathogenesis of *C. trachomatis* infection

*C. trachomatis* causes disease mainly by (a) direct destruction of infected host cells during multiplication and (b) inducing inflammatory responses in the host. *C. trachomatis* enters the host through minute abrasions or injuries in the skin. The bacteria react specifically with the receptors that are found on the non-ciliated columnar, cuboidal, or transitional epithelial cells. These epithelial cells are typically found on the mucous membranes of the conjunctiva and genitourinary system, such as urethra, endocervix, endometrium, fallopian tube, and respiratory tract.

The LGV biovar multiplies in mononuclear phagocytes found in the lymphatic system. The pathological lesions are typically found in the lymph nodes draining the site of primary infection. Granuloma is characteristic pathological lesion. Subsequently inflammatory process spreads to other surrounding tissues and finally rupture of the lymph nodes leads to the formation of abscess or sinus tracts.

Infections with trachoma serovars are associated with severe inflammatory reaction consisting of neutrophils, lymphocytes, and plasma cells as seen in case of trachoma.

### ► Host immunity

Infections with *C. trachomatis* do not induce any long-lasting immunity. Instead reinfection by *C. trachomatis* typically

produces a strong inflammatory response with severe tissue damage. Such responses are responsible for causing loss of vision in patients with chronic ocular infections and sterility and sexual dysfunction in patients with genital infections.

## Clinical Syndromes

*C. trachomatis* causes a variety of diseases. It is an important cause of genital and ocular infections worldwide. *C. trachomatis* LGV biovar causes lymphogranuloma venereum (LGV) and ocular LGV. *C. trachomatis* trachoma biovar causes (a) trachoma, (b) adult inclusion conjunctivitis, (c) neonatal conjunctivitis, (d) infant pneumonia, and (e) urogenital infections.

### ► Lymphogranuloma venereum

*C. trachomatis* LGV biovar (serotypes L1, L2, L2a, L2b, and L3) causes lymphogranuloma venereum. Serotype L2 is most commonly responsible for the condition. LGV is a sexually transmitted disease that affects the cervix, urethra, salpinges, and epididymis. Incubation period varies from 1 to 4 weeks.

#### Key Points

- A small painless papule or ulcerative lesion is the primary lesion, which appears on the external genitalia in patients with LGV.
- Penis in male, fourchette in females, and rectum in homosexuals are the common sites of infection. Occasionally, primary lesions may be found on the extragenital sites (e.g., fingers and palms).
- The absence of pain in ulcers is the typical manifestation, which differentiates the ulcers from the painful ulcers found in herpes simplex virus infection and syphilis.

Fever, headache, and myalgia are the other associated symptoms. Inflammation and swelling of the lymph nodes draining the primary site of infection is the next stage of the disease. The regional lymph nodes, such as inguinal lymph nodes in males and intrapelvic and pararectal lymph nodes in females, are most commonly involved. These lymph nodes become painful, enlarged, fluctuant, and finally may rupture with the formation of draining fistulas. Such lymph nodes are called buboes. Fever, chills, anorexia, headache, and myalgia are the other associated manifestations.

Proctitis is a common manifestation in women with LGV (Color Photo 52). This occurs due to lymphatic spread of the bacteria from the infected cervix or the vagina. Proctitis also occurs in men, resulting from lymphatic spread from the urethra or following anal intercourse. In untreated cases of LGV, the infection may progress to a chronic ulcerative stage leading to development of ulcers, strictures, fistula, or genital elephantiasis. In some other cases, the infection may resolve at this stage.

### ► Ocular LGV

*C. trachomatis* LGV biovar also causes ocular LGV. This causes Parinaud's oculogenital conjunctivitis. It is a condition characterized by inflammation of the conjunctiva associated with periauricular, submandibular, and cervical lymphadenopathy.

### ► Trachoma

Trachoma is a communicable disease of the eye caused by *C. trachomatis* serotypes A, B, Ba, and C. This is a condition characterized by follicular hypertrophy, papillary hyperplasia, pannus formation, and in late stages cicatrization. The condition begins in patients with follicular conjunctivitis with diffuse inflammation that affects entire conjunctiva. Subsequently, the condition progresses with the formation of pannus, which indicates invasion of blood vessels of cornea and finally loss of vision. The loss of vision is the most important and serious complication of trachoma.

### ► Adult inclusion conjunctivitis

Adult inclusion conjunctivitis results from the infection with *C. trachomatis* strains associated with genital infection (A, B, Ba, and D–K). This infection is more frequently seen in sexually active adults. The condition can also occur in neonates. A unilateral and less commonly binocular red eye, ocular discharge, marked hyperemia, papillary hypertrophy, and a predominant follicular conjunctivitis are the important manifestations. The condition if untreated progresses to a chronic remittent course, keratitis, and possible iritis.

### ► Neonatal conjunctivitis

This is the neonatal form of inclusion conjunctivitis. The condition develops in infants acquiring the infection from infected birth canal. The infection is usually seen in infants born to pregnant mothers who have chlamydial infections of the cervix.

Incubation period varies from 5 to 12 days. Swelling of the infant's eyelid, hyperemia, and purulent discharge characterize the condition. Conjunctival scarring and corneal vascularization occurs in untreated infections of long duration.

### ► Infant pneumonia

Infant pneumonia caused by *C. trachomatis* is seen in infants between 4 and 16 weeks of age. It is one of the most common causes of pneumonia in the newborns. This infection is seen in 60% of neonates born to infected mothers.

The incubation period is variable but usually takes 2–3 weeks after birth. The condition is characterized by respiratory symptoms, such as rhinitis with cough and wheezing. Child is usually afebrile during the disease.

### ► Urogenital infections

Urogenital infection is the most common infection caused by *C. trachomatis*. Approximately, 80% of infected females and 50% of infected males are asymptomatic. Genital chlamydiasis is the most common sexually transmitted disease worldwide.

The clinical manifestations in symptomatic patients include urethritis (nongonococcal urethritis), epididymitis, proctitis, and conjunctivitis in males; in females, it causes a mucopurulent cervicitis, endometritis, and salpingitis.

Ascending infection can result in pelvic inflammatory disease, chronic pelvic pain, and perinephritis. Chlamydial infection with *C. trachomatis*; especially serotype C is shown to be at a risk of developing cervical cancer, nearly 6.5 times more than in women without infection.

### Key Points

**Reiter's syndrome** is a triad of recurrent conjunctivitis, polyarthritis, and urethritis or cervicitis, and is most commonly associated with genital infection caused by *C. trachomatis*. This condition is seen in both men and women. Approximately, 50–60% of patients with Reiter's syndrome have a genital infection with *C. trachomatis* at onset of arthritis. EBs have been demonstrated in synovial fluid of patients suffering from arthritis.

## Epidemiology

*C. trachomatis* is distributed worldwide.

### ► Geographical distribution

LGV caused by *C. trachomatis* is highly prevalent in Asia, Africa, and South America. The disease occurs sporadically in Europe, Australia, and North America. LGV is responsible for 10% of genital ulcer disease in developing countries. Genital chlamydia and gonorrhea caused by *Neisseria gonorrhoeae* may often coexist. These two pathogens are the most common causes of epididymitis in sexually active adult men. Trachoma is worldwide in distribution and nearly 500 million people are infected worldwide. The infection is endemic in the Middle East, Africa, Far East, and India. The condition is responsible for blindness in 7–9 million patients. Trachoma is particularly prevalent in these countries because of overcrowding, poor sanitation, and poor personal hygiene. All these factors facilitate transmission of infection. Moreover, *C. trachomatis* is the common cause of infant pneumonia worldwide.

### ► Habitat

*C. trachomatis* is a strict human pathogen. It is found in the conjunctiva and genitourinary tract in an infected host. *C. trachomatis* also inhabits the respiratory and gastrointestinal tracts of humans.

### ► Reservoir, source, and transmission of infection

Humans are the only natural host of *C. trachomatis* and thus are only significant reservoir of infections. Ocular discharges from infected cases are the common source of eye infection for trachoma. Occasionally, respiratory discharges and human feces can be a source of infection.

Trachoma is transmitted by eye-to-eye contact through (a) droplets, (b) contaminated hands, and (c) contaminated

clothings. All these methods facilitate transmission of ocular discharges from the eyes of infected children to those of normal children. Trachoma is also transmitted by inoculation of respiratory droplets or by ingestion of food and water contaminated with human feces. Genital discharges are the source of infection for adult inclusion conjunctivitis. Adult inclusion conjunctivitis is usually transmitted by orogenital contact and also by autoinoculation. Although rare, eye–hand transmission has been reported for adult inclusion conjunctivitis.

Inclusion conjunctivitis in the newborns is acquired by the infants born vaginally from mothers who are infected with *C. trachomatis*. *C. trachomatis* eye infection occurs in approximately 25% of infants whose mothers' genital tract is infected with *C. trachomatis*.

Infected genital discharge is also the source of infection for pneumonia of the newborn. Pneumonia develops in 10–20% of infants during their birth through an infected birth canal. Chlamydial genital infections are usually caused by vaginal, anal, and oral sexual contact.

## Laboratory Diagnosis

Various approaches are there for laboratory diagnosis of chlamydial infections as mentioned below. The sensitivity of these methods, however, depends on (a) the nature of the disease, (b) site of infection from where the specimen is collected, and (c) the population of the patient examined.

### ► Specimens

Specimens from urethra, cervix, rectum, oropharynx, and conjunctiva are the frequently collected specimens. In addition, other specimens such as, blood, respiratory secretions, sputum, lung, and other tissues are collected and examined. Pus from bubo is also useful for diagnosis of LGV.

### ► Microscopy

Laboratory diagnosis of chlamydial infection is made by microscopic examination of various clinical specimens for demonstration of chlamydial inclusion bodies. These inclusion bodies can be demonstrated in specimens stained by Giemsa, Castaneda, Machiavello, or Gimenez stains. *C. trachomatis* infections of conjunctiva, urethra, and cervix are diagnosed by demonstration of typical reniform inclusion bodies surrounding the nucleus in the stained smear of conjunctiva, urethra, and cervical smears.

### Key Points

**Iodine staining of conjunctival scrapings** is a simple and rapid method for diagnosis of TRIC. Iodine stains the glycogen matrix of inclusion bodies of *C. trachomatis*. However, iodine staining is a method of poor sensitivity and is positive only in certain stages of development of inclusion bodies in infected cells. This is more useful for demonstration of chlamydial inclusion bodies in the cell cultures inoculated with clinical specimens.

## ► Culture

Isolation of *C. trachomatis* in cell cultures is the more specific method for diagnosis of *C. trachomatis* infection. Clinical specimens are inoculated in different cell lines for isolation of *Chlamydia*. The sensitivity of the cell cultures for isolation of *C. trachomatis* is increased by (a) pretreatment with cycloheximide (i.e., a metabolic inhibitor, which inhibits the metabolism of host cells) and (b) use of irradiated cell lines (treated McCoy cells are most commonly used cell lines for isolation of *C. trachomatis*).

*C. trachomatis* infection in cell culture is demonstrated by the presence of intracellular inclusion bodies. These are detected by the use of iodine stains or fluorescence-conjugated antibodies. The culture methods are difficult and expensive. These are specifically preferred for isolation of *C. trachomatis* from rectal specimens, because noncultural methods are usually negative. The culture shows a sensitivity of 50–90% and specificity of 99%.

## ► Antigen detection

Chlamydial antigen can be detected in clinical specimens by direct fluorescent antibody (DFA) staining and enzyme immunoassay (EIA). Antibodies prepared against either the *Chlamydia* MOMP or the cell wall LPS are used to detect antigens in clinical specimens by these two methods.

Both DFA staining and EIA are approximately 80% sensitive and 95% specific. Both the methods, however, are labor intensive and require trained personnel.

## ► Serodiagnosis

Serodiagnosis is based on detection of antibodies against *C. trachomatis* in serum. Patients with LGV show a very high level of serum antibodies. Antibody-based tests are useful for diagnosis of LGV. CFTs, microimmunofluorescence (MIF), and ELISA are employed to detect specific antibodies in the sera:

- **CFT** uses a genus-specific LPS antigen for detection of antibodies. A single serum showing a high antibody titer of 1:256 or more, or a fourfold increase in antibody titer of a paired sera sample is highly suggestive of LGV.
- **MIF** test is a specific test, which utilizes the species- and serovar-specific antigens, such as *Chlamydia* MOMP. Confirmation of LGV is carried out by the MIF test.
- **ELISA** is a genus-specific test that uses LPS antigen like CFT.

The antibodies-based serological tests are of limited value in diagnosis of urogenital infections caused by *C. trachomatis*. This is because antibody titers cannot differentiate between recent and past infection, since antibodies are present in circulation for a long period of time. Detection of IgM antibody by ELISA, however, is very useful for diagnosis of *Chlamydia* pneumonia in infants.

## ► Frei's skin test

Frei's test is an intradermal skin test used for the diagnosis of LGV. A heat-inactivated *C. trachomatis* LGV serovar grown in the yolk sac of embryonated egg is used as antigen and 0.1 mL of antigen is injected intradermally in the forearm and a control antigen prepared from uninfected yolk sac is injected in the other forearm.

Frei's skin test is a delayed hypersensitivity reaction in which positive reaction is shown by development of an inflammatory macule, measuring >7 mm in diameter, on the test arm after 2 days. The nodule reaches maximum size within 4–5 days. The skin test becomes positive 2–6 weeks after infection and remains positive for several years. However, nowadays skin test is rarely used for diagnosis.



## Molecular Diagnosis

Molecular diagnosis of *C. trachomatis* infection is made by DNA probes and PCR (polymerase chain reaction). DNA probes are currently available, which detect the presence of a species-specific sequence of 16S rRNA. This method is not highly sensitive.

PCR is used for diagnosis of infection with a reported sensitivity of 80–90% and specificity of 99%. The method is useful specifically for testing urine specimens, but is less sensitive for detection of the bacteria in genital swabs collected from infected women.

## Treatment

Azithromycin is the drug of choice for treatment of genital chlamydial infections. This antibiotic has the advantage of being given in a single dose regimen and has high tolerability and few contraindications. Tetracyclines are usually recommended for treatment of patients with LGV for at least 3 weeks. Children below 9 years, pregnant women, and patients unable to tolerate tetracyclines are treated with a macrolide, such as erythromycin or azithromycin in combination with sulfisoxazole.

Doxycycline for 7 days or fluoroquinolone (e.g., ofloxacin) for 7 days is also effective for treatment of genital and ocular infections. Erythromycin given for 10–14 days is very useful for treatment of conjunctivitis in infants and infant pneumonia. Erythromycin may be administered orally and topically for treatment of ophthalmia neonatorum.

Local application and oral administration of erythromycin and tetracycline given for several weeks are effective for treatment of trachoma.

## Prevention and Control

Although it is difficult to prevent *C. trachomatis* infection, the morbidity (such as, blindness associated with trachoma) can be prevented by immediate treatment at early stage of the disease and by taking measures to prevent re-exposure to the bacteria. Chlamydial genital infections are prevented by using safe sexual practices and by prompt treatment of symptomatic patients and their partners.

## Chlamydo*phila*

*C. pneumoniae* was first isolated from the conjunctiva of a child in Taiwan in 1965 and subsequently from throat of a patient with pharyngitis in 1983. These organisms were initially believed to be *C. psittaci* strains TWAR (from Taiwan acute respiratory),

because they produced inclusion bodies in cell cultures similar to those produced by *C. psittaci*. Taiwan isolate was designated as TW-183, and the pharyngeal isolate was designated as AR-9. These two strains were initially believed to be related to psittaci strains, but later on were found to be different. These two organisms were then classified as *Chlamydia pneumoniae* but now have been reclassified and finally placed in a new genus *Chlamydophila*.

### *Chlamydophila pneumoniae*

*C. pneumoniae* is the third common cause of pneumonia following *Streptococcus pneumoniae* and *Haemophilus influenzae*. It is an important cause of respiratory disease in older children and adults worldwide. *C. pneumoniae* causes mostly asymptomatic infections. Pharyngitis, sinusitis, bronchitis, and pneumonia are the common manifestations of symptomatic cases in severe respiratory tract infection.

*C. pneumoniae* is also a strict human pathogen and does not have any animal reservoir. Infection is transmitted by respiratory secretions from person to person without any avian or animal host. Approximately, 2–3 lakh cases of *C. pneumoniae* occur every year, and most of these cases occur in adults.

Diagnosis of infection is made by demonstration of *C. pneumoniae* antigen in specimens by enzyme immunoassay or DFA test. Diagnosis by culture is not done as *C. pneumoniae* grows poorly in cell cultures. Serodiagnosis is carried out by using CFT, ELISA, or MIF. Antibodies have been demonstrated in sera of more than 50% of people. PCR is also used to detect bacterial genome in the specimen.

Tetracycline, doxycycline, erythromycin, and azithromycin are given for 10–14 days for treatment of *C. pneumoniae* infection. Control of *C. pneumoniae* infection is difficult.

### *Chlamydophila psittaci*

*C. psittaci* is the causative agent of psittacosis, a disease of parrots and psittacine birds which can be transmitted to humans. The disease was first observed in parrots, hence named psittacosis (Greek word *psittakos* means parrot). A similar disease of nonpsittacine birds was called ornithosis (Greek word *ornithos* means bird). Now both the conditions are called psittacosis.

Infection in birds may occur as asymptomatic or symptomatic. Symptomatic infection may manifest as respiratory infection, diarrhea, and emaciation. In the infected birds, the bacteria are present in the blood, tissue, and feathers and are also excreted in the feces, nasal discharges, aerosols, etc.

*C. psittaci* can be transmitted from birds to humans as well as sheep, cows, and goat. Humans acquire the infection mostly from psittacine birds, such as parrots, parakeets, cockatiels, and macaws. They get infected by inhalation of dried bird droppings, urine, or respiratory secretions of these infected birds.

Human infections are mostly occupational, and veterinarians, poultry workers, pet-shop workers, pigeon farmers, etc. are at increased risk for this infection. Person-to-person transmission is rare. Ingestion of poultry birds also does not cause any infection. Laboratory infection is well documented.

*C. psittaci* in humans causes a clinical syndrome, which varies from a mild influenza-like illness to a fatal pneumonia. Incubation period varies from 5 to 14 days. Headache, high fever, chills, malaise, and myalgia are the symptoms at the initial stage of the illness. Nonproductive cough, rales, and consolidation are the respiratory manifestations. The untreated cases may be severe and progress to encephalitis, endocarditis, pericarditis, and even death (Fig. 49-2).

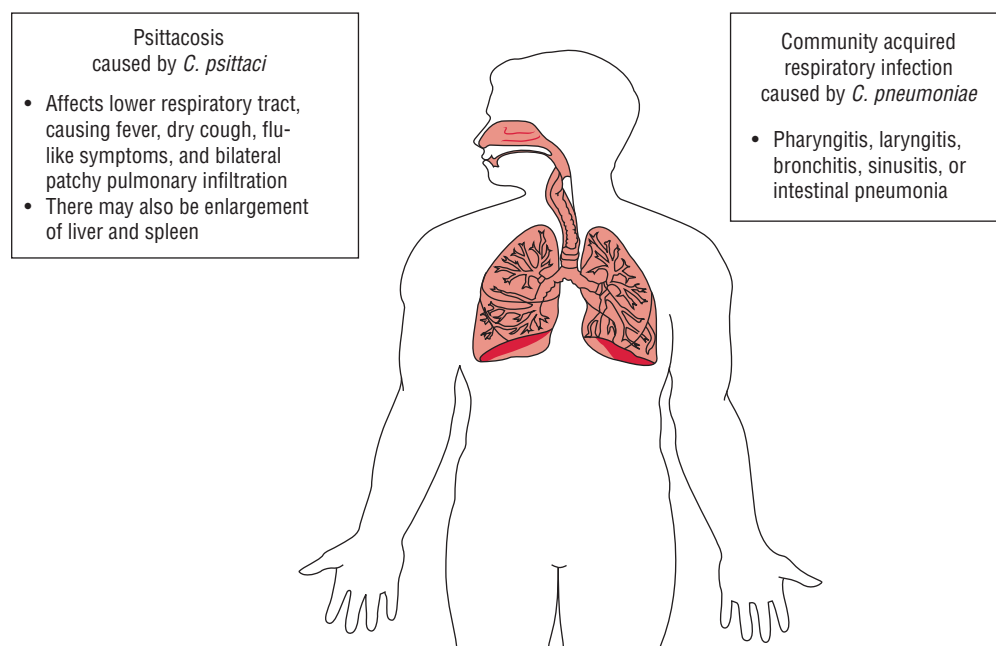

FIG. 49-2. Clinical manifestations caused by *Chlamydophila psittaci* and *Chlamydophila pneumoniae*.



Laboratory diagnosis of the condition is based mainly on the serological tests. Demonstration of a fourfold rise in antibody titer in the paired acute and convalescent sera by the CFT is suggestive of *C. psittaci* infection. MIF test is a specific test used to confirm the diagnosis.

**Levinthal-Cole-Lille (LCL) inclusion bodies:** These are demonstrated in mouse brain, yolk sac, cell cultures, and in infected cells including alveolar macrophages from patients suffering

from *C. psittaci* infection. These inclusion bodies are not stained by iodine, and are more diffuse and irregular. They are not inhibited by sulfadiazine or cycloserine. *C. psittaci* can be grown in cell cultures, such as L cells after 5–10 days of incubation, but is not used routinely.

Tetracycline, doxycycline, erythromycin, and azithromycin are useful for treatment of *C. psittaci* infection. Infection is prevented by controlling it in birds.



## CASE STUDY

A 6-year-old boy attended the Ophthalmology OPD with symptoms of conjunctivitis of the right eye. Examination showed follicular hypertrophy with diffuse inflammation that had affected the entire conjunctiva along with pannus formation. Iodine staining of conjunctival scrapings demonstrated inclusion bodies of *Chlamydia trachomatis*. The condition was diagnosed as trachoma.

- List *C. trachomatis* serovars that cause the disease.
- Describe laboratory diagnosis of the condition.
- Describe other infections caused by *C. trachomatis*.
- What is Frei's skin test? Describe the test. For which *C. trachomatis* infection this test is used?

"This page intentionally left blank"

"This page intentionally left blank"

"This page intentionally left blank"

# General Properties of Viruses

## Introduction

The viruses are too small to be seen with a light microscope. Their small size allows them to pass through filters that are used to retain back bacteria in contaminated fluids. Hence, they were first described as filterable agents. Viruses, like other microorganisms (e.g., bacteria, fungi, and parasites), are the infectious agents that are associated with disease in humans. The viruses unlike other infectious agents are obligate intracellular parasites, i.e., they absolutely require living host cells in order to multiply. In addition, viruses replicate by assembly of the individual components rather than by binary fission. The viruses show the following features:

1. They are filterable agents.
2. They are obligate intracellular parasites.
3. They contain a single type of nucleic acid, i.e., either DNA or RNA, but not both.
4. The virion of the virus particle consists of a nucleic acid genome packaged into a protein coat (capsid), which itself is sometimes enclosed by an envelope of lipid, proteins, and carbohydrates known as envelope.
5. They multiply inside the living cells by using the synthesizing machinery of the host cell.
6. They replicate by the assembly of the individual components and do not replicate by division, such as binary fission.
7. They have a few or no enzymes for their own metabolism. They always use host cell machinery to produce their components, such as viral messenger RNA (mRNA), protein, and identical copies of the genome.

The differences between bacteria and viruses are summarized in Table 50-1. The viruses affect a wide range of hosts. There are viruses that infect invertebrates, vertebrates, plants, protists, fungi, and even bacteria. In medical microbiology, we are concerned mainly with viruses that infect either humans or bacteria. The viruses that infect bacteria are known as *bacteriophages or phages*.

## Morphology of Viruses

The extracellular, infectious viral particle is called the *virion*:

- It is a complete, fully developed infectious viral particle composed of nucleic acid surrounded by a protein coat. The latter protects it from the environment and is a vehicle of transmission from one host to another. The viruses are classified on the basis of differences in structure of these coats.
- The virion may be enveloped by being surrounded by a membrane or may be nonenveloped, without being surrounded by a membrane.
- The virion may also contain essential or accessory enzymes or other proteins.

TABLE 50-1

Comparison of bacteria, rickettsiae, chlamydiae, and viruses

Character	Typical bacteria	Rickettsiae	Chlamydiae	Viruses
Intracellular parasite	No	Yes	Yes	Yes
Cellular organization	Yes	Yes	Yes	No
Plasma membrane	Yes	Yes	Yes	No
Replication by binary fission	Yes	Yes	Yes	No
Growth on inanimate media	Yes	No	No	No
Pass through bacteriological filters	No	No	Yes	Yes
Possess both DNA and RNA	Yes	Yes	Yes	No
ATP-generating metabolism	Yes	Yes	No	No
Ribosome	Yes	Yes	Yes	No
Sensitive to antibiotics	Yes	Yes	Yes	No
Sensitive to interferon	No	No	Yes	Yes

## Size

The clinically important viruses vary widely in their size (Fig. 50-1). They range from as small as 20-nm viruses (picornaviruses) to as large as 300-nm viruses (poxvirus). Passing the viruses through collodion membrane filter with different pore sizes was the earliest method of determining the size of the virus. Subsequently, ultracentrifugation method was used to determine the size of the viruses by calculating from the rate of sedimentation of virus in the ultracentrifuge. Electron microscopy is the most recent method for determining the size as well as the shape of the virus.

## Structure and Symmetry of Virus

### ► Viral structure

The virion consists of a nucleic acid core, the *genome*, surrounded by a protein coat, the capsid (Fig. 50-2). The capsid together

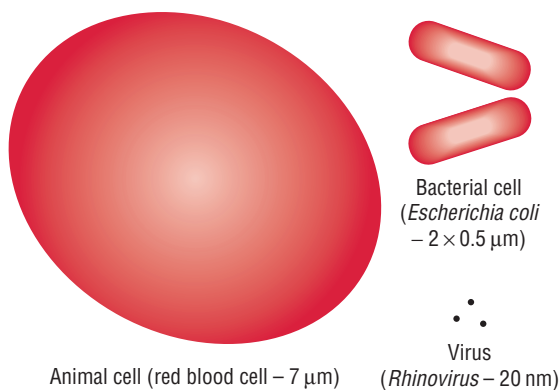

**FIG. 50-1.** A schematic diagram showing comparative sizes of virus, bacterial cell, and animal cell.

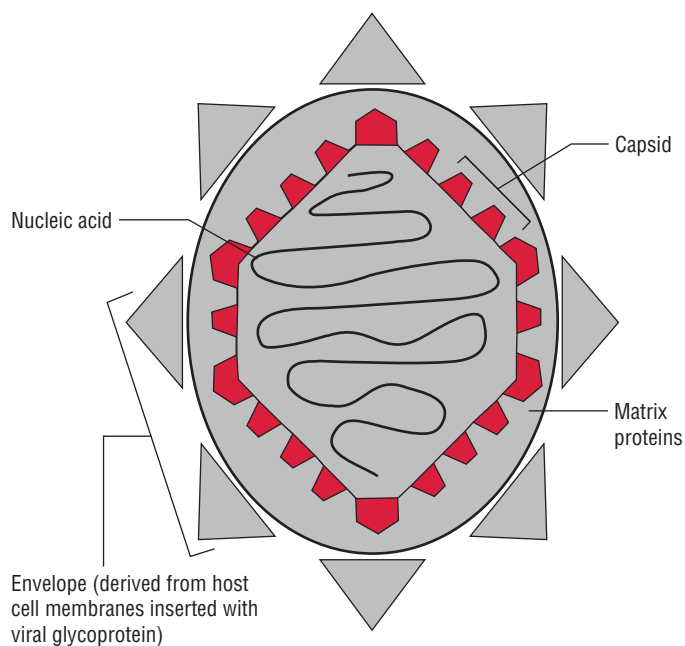

**FIG. 50-2.** Schematic diagram of structure of a virus.

with the enclosed nucleic acid is known as the *nucleocapsid*. Some viruses are surrounded by envelopes.

### The capsid

The nucleic acid of a virus is surrounded by a protein coat called the capsid. Each capsid is composed of a large number of protein subunits (polypeptides) called *capsomeres*, which form its morphological units. The polypeptide molecules composing the capsomeres are of a single type in some viruses, while in other viruses several types may be present. The arrangement of capsomeres is characteristic of a particular type of virus.

## Key Points

### Functions of capsid

- Symmetrically arranged polypeptide molecules of capsid form an impenetrable shell around the nucleic acid core.
- The capsid facilitates entry of viral genome into the host cells by adsorbing readily to cell surfaces.
- The capsid of the virus protects its nucleic acid from the activity of nuclease enzymes in biological fluids and thereby facilitates attachment of virus to target cells in the host.

The structure of the viral capsid is best demonstrated by X-ray crystallography or electron microscopy. On the basis of capsid structure, the viruses can be classified into different morphological types as follows:

**Helical viruses:** The helical viruses appear rod-like and may be rigid or flexible. The viral genome is found within hollow cylindrical capsid that has a helical structure. The examples of helical viruses include rabies virus, Ebola hemorrhagic virus, etc.

**Polyhedral viruses:** The polyhedral viruses appear as many-sided viruses. The viruses consist of capsids in the shape of an icosahedron. It is a regular polyhedron with 20 triangular faces. The capsomere of each face forms an equilateral triangle. Adenovirus is an example of polyhedral virus in the shape of icosahedron.

**Enveloped viruses:** The helical and polyhedral viruses when covered by envelope are called as enveloped helical or enveloped polyhedral viruses, respectively. Influenza virus is an example of enveloped helical virus, and herpes simplex virus is an example of enveloped polyhedral virus.

**Complex viruses:** Some viruses, such as viruses of bacteria (e.g., bacteriophages), have complicated structures and are called complex viruses. The detailed structure and function of bacteriophages are described in Chapter 54.

### The envelope

In some viruses, the capsid is covered by an envelope, such viruses are called enveloped viruses. All of the negative-stranded RNA viruses are enveloped. The viruses that lack envelope are called nonenveloped or naked viruses. Properties of the enveloped and naked viruses are summarized in Tables 50-2 and 50-3, respectively.

The virion envelope usually consists of lipids, proteins, and glycoproteins. It has a membrane structure similar to cellular membrane of the host cell. The viral envelope does not contain any cellular proteins, even though viruses are released from the host cell by an extrusion process that coats the virus with a layer of host cell plasma membrane that becomes the viral envelope. In most cases, the envelope contains proteins that are determined and encoded by viral nucleic acid. The lipid component of the envelope is usually of host cell origin.

Depending on the virus, the envelopes of the viruses may or may not be covered by spikes. The spikes are glycoprotein-like projections on the outer surface of the envelope. Most spikes act as viral attachment protein (VAP).

- The VAP that binds to red blood cells is called hemagglutinin. The ability of certain viruses, such as influenza virus to agglutinate red blood cells is due to the presence of these hemagglutinins. The process is called hemagglutination and it forms the basis of hemagglutination inhibition test used in the viral serology.
- The VAPs in some viruses perform different functions, such as neuraminidase activity of influenza virus, fusion glycoprotein of paramyxovirus and C3b receptor associated with herpes simplex virus.

The structural components of envelope remain biologically active only in aqueous solutions and are readily destroyed by drying or on treatment with acids, detergents, and solvents, such as ether, leading to inactivation of virus. They are rapidly killed in stomach due to sensitivity of enveloped components

to gastric acidity. Therefore, most of the enveloped viruses are usually transmitted through body fluids, such as blood, respiratory droplets, tissue exudates, etc.

### ► Viral symmetry

Three types of symmetry are observed depending on the arrangement of the capsid around the nucleic acid core (genome). These are (a) icosahedral (cubical), (b) helical, and (c) complex symmetry.

**Icosahedral symmetry:** Two types of capsomeres constitute the icosahedral capsule. They are the pentagonal capsomeres or the vertices (*pentons*) and hexagonal capsomeres making up the facets (*hexons*) (Fig. 50-3). There are always 12 pentons, but the number of hexons varies with the virus group.

Each penton has fivefold symmetry (pentamer or pentagon) in the shape of an equilateral triangle. This pentamer symmetry is found in simple viruses, such as the picornaviruses and parvoviruses. In picornaviruses, each pentamer is made up of five protomers, each of which is composed of three subunits of four different proteins.

The hexamer symmetry is usually found in large capsid virions, such as herpesviruses and adenoviruses. Hexons are made up of certain structurally distinct capsomeres between the pentons at the vertices. The presence of hexon extends the icosahedral and is called an icosadeltahedral. The adenovirus nucleocapsid has 12 pentons and 240 hexons, whereas the herpesvirus nucleocapsid has 12 pentons and 150 hexons surrounded by an envelope.

**TABLE 50-2** Properties of enveloped virus

Component	Properties	Biological functions
<ul style="list-style-type: none"> <li>■ Membrane</li> <li>■ Lipids</li> <li>■ Proteins</li> <li>■ Glycoprotein</li> </ul>	<ul style="list-style-type: none"> <li>■ Environmentally labile; disrupted by acid, detergents, drying, and heat</li> <li>■ Modifies cell membrane during replication</li> <li>■ Released by budding and cell lysis</li> </ul>	<ul style="list-style-type: none"> <li>■ Must stay wet</li> <li>■ Cannot survive in the gastrointestinal tract</li> <li>■ Spreads in large droplets, secretions, organ transplants, and blood transfusion</li> <li>■ Does not need to kill the cell to spread</li> <li>■ May need antibody- and cell-mediated immune response for protection and control</li> <li>■ Elicits hypersensitivity and inflammation to cause immunopathogenesis</li> </ul>

**TABLE 50-3** Properties of naked virus

Component	Properties	Biological functions
<ul style="list-style-type: none"> <li>■ Protein</li> </ul>	<ul style="list-style-type: none"> <li>■ Environmentally stable to temperature, acid, proteases, detergents, and drying</li> <li>■ Is released from cell by lysis</li> </ul>	<ul style="list-style-type: none"> <li>■ Can be spread easily through fomites, from hand to hand, by dust, and by small droplets</li> <li>■ Can dry out and retain infectivity</li> <li>■ Can survive the adverse conditions of the gut</li> <li>■ Can be resistant to detergents and poor sewage treatment</li> <li>■ Antibody may be sufficient for immunoprotection</li> </ul>

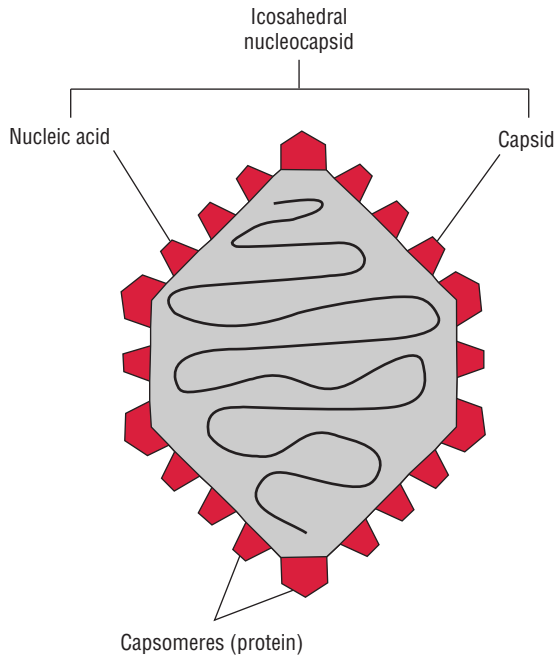

FIG. 50-3. Icosahedral symmetry of a virion.

**Helical symmetry:** The nucleic acid and the capsomeres are wound together to form a spherical or spiral tube. The viruses with helical structure usually appear as rods and their capsomeres self-assemble on the RNA genome into rods extending to the length of the genome. These capsomeres cover and protect the RNA. The tubular nucleocapsid structure may be rigid as in tobacco mosaic virus, but may be pliable and may be coiled on itself in case of some other animal viruses. Helical nucleocapsids are usually demonstrated within the envelope of most negative-stranded RNA viruses.

**Complex symmetry:** Some viruses may not exhibit either icosahedral or helical symmetry but instead may exhibit a complex symmetry. For example, poxvirus shows a complex symmetry.

### ► Shape

Most of the enveloped viruses are round or pleomorphic with exception of poxvirus and rhabdovirus. Rhabdovirus is a bullet-shaped virus, whereas poxvirus is brick shaped.

## Viral Nucleic Acid, Proteins, and Lipids

### ► Viral nucleic acid

The genome of the virus consists of either DNA or RNA but never both (Fig. 50-4). The DNA can be single stranded or double stranded. Depending on the virus, the DNA can be linear or circular. The RNA can be either positive sense (+) like mRNA or negative sense (-), double stranded (+/-), or ambiguous (containing + and - regions of RNA attached to it). In some RNA viruses, such as the influenza virus, the RNA genome

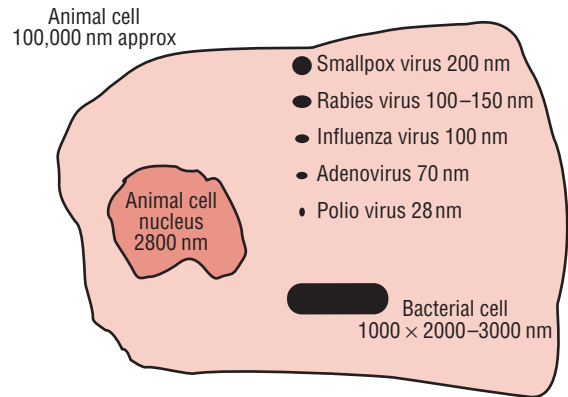

FIG. 50-4. Size of the viruses.

is in several separate segments, each segment encoding an individual gene.

The total amount of nucleic acid may vary from a few thousand nucleotides to as many as 250,000 nucleotides.

### ► Viral proteins and lipids

Viruses contain proteins, which constitute capsids. The viral protein protects the nucleic acid as well as determines the antigenic specificity of the virus. In addition, the enveloped viruses contain lipids, which are derived from the host cell membrane.

## Susceptibility to Physical and Chemical Agents

### ► Disinfectants

The viruses are usually more resistant than bacteria to chemical disinfectants. Most viruses are relatively resistant to phenol. The oxidizing agents, such as hydrogen peroxide, potassium permanganate, hypochlorite, and organic iodine compounds, are most active antiviral disinfectants. Formaldehyde and  $\beta$ -propiolactone are also active virucidal agents, which are commonly used for preparation of killed viral vaccines.

The chlorination of drinking water is useful for killing most of the common viruses with exception of hepatitis A and polioviruses. These two viruses are relatively resistant to chlorination.

### ► Temperature

Most of the viruses with few exceptions are highly heat labile. They are inactivated within seconds at 56°C, within minutes at 37°C, and within days at 4°C.

- The viruses such as influenza, measles, and mumps are very labile and may survive outside the host only for a few hours.
- Other viruses, such as polio and hepatitis A, are relatively much stable and may survive for many days, weeks, or even months in the environment.



- Viruses, such as hepatitis B, show resistance to heating at 60°C for 60 minutes; slow viruses, such as scrapie virus, are resistant to autoclaving at 121°C for 15 minutes.

The viruses are stable at low temperature. They can be stored by freezing at -35°C or -70°C. Lyophilization or freeze-drying is useful for long-term storage of the viruses. The poliovirus is an exception, as it does not withstand freeze-drying.

### ► pH

The viruses usually remain viable in a pH range of 5–9, but are sensitive to extremes of acidity and alkalinity. Rhinoviruses are very susceptible to acidic pH, while enteroviruses are highly resistant.

### ► Lipid solvents

Ether, chloroform, and detergents are active against enveloped viruses but are not active against nonenveloped, naked viruses.

### ► Radiations

The viruses are readily inactivated by sunlight, ultraviolet (UV) radiations, and ionizing radiations.

## Replication of Viruses

The replication of viruses in the host cell depends upon the synthesis mechanism of the host cell for manufacture of different viral components. The genetic information for viral multiplication is present in the viral nucleic acid. Multiplication of viruses follows the basic pattern of bacteriophage multiplication, but has several important differences (Box 50-1).

The multiplication of viruses, both DNA- and RNA-containing viruses, is divided into six phases as follows: (i) attachment, (ii) penetration, (iii) uncoating, (iv) biosynthesis, (v) maturation, and (vi) release (Fig. 50-5).

## Attachment

Attachment or adsorption is the first event in the infection of the cell by a virus. The viruses have attachment sites that attach to the complementary receptor sites on the host cell surface. These receptor proteins in the virus are distributed on surface of the virus. These receptor proteins vary from one virus to another (Table 50-4). For example, in influenza virus these receptor proteins are the spikes present on the surface of the envelope, whereas in adenovirus these receptor proteins are small fibers present at the corner of the icosahedron.

The attachment sites of the virus bind specifically to the complementary receptors on the surface of the host (Table 50-5). These receptor sites on the cell vary depending on the nature of the virus:

- Rabies virus binds specifically to the acetylcholine receptors found on neural cells
- HIV-1 binds specifically to the CD4, a 60-kDa glycoprotein on the surface of mature T lymphocytes.
- Influenza virus binds specifically to sialic acid residue of glycoprotein receptor sites on the surface of respiratory epithelium.

Susceptibility of the host to virus infection, therefore, depends upon the presence or absence of receptors on the cell surface.

### Box 50-1 Steps in viral replication

- Recognition of the target cell.
- Attachment of the virus particle to the cell surface.
- Penetration into the host cells.
- Uncoating of the virus of its outer layers and capsid.
  - Transcription of mRNA from viral nucleic acid.
  - Translation of mRNA into “early proteins.”
  - Replication of viral nucleic acid.
  - Synthesis of late proteins.
- Assembly of virus in the nucleus or cytoplasm.
- Budding of enveloped viruses.
- Release of virus.

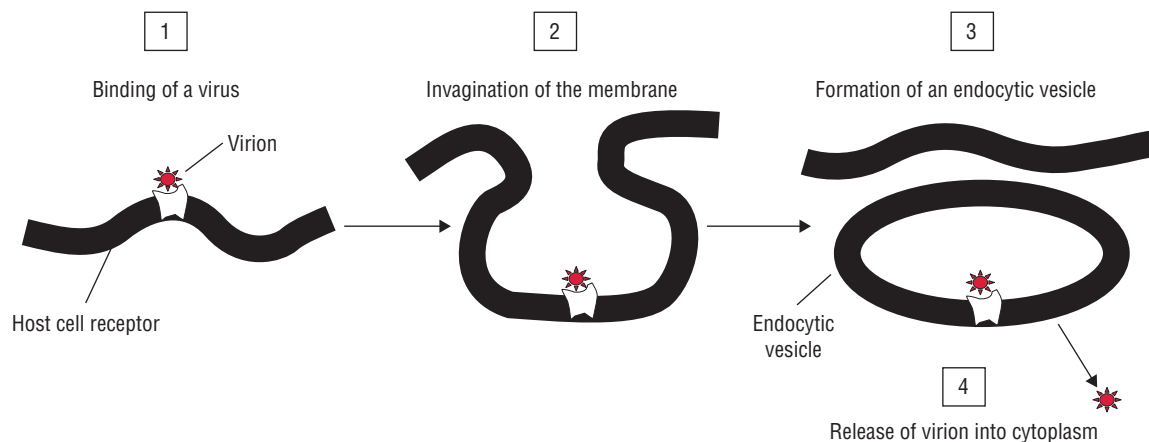

FIG. 50-5. Replication of virus.

TABLE 50-4

Examples of VAPs

Virus	VAP
Adenovirus	Fiber protein
Epstein-Barr virus	gp 350 and gp 220
Human immunodeficiency virus	gp 120
Influenza A virus	HA
Measles virus	HA
Rabies virus	G protein
Reovirus	–1
Rhinovirus	VP1–VP2–VP3 complex
Rotavirus	VP7

VAP, viral attachment protein; HA, hemagglutinin; gp, glycoprotein.

TABLE 50-5

Examples of viral receptors in host cells

Virus	Receptor
Epstein-Barr virus	C3d complement receptor CR2 (CD21) in B cell
Human immunodeficiency virus	CD4 molecule and chemokine coreceptor in helper T cell
Rhinovirus	ICAM-1 (immunoglobulin superfamily protein) in epithelial cells
Poliovirus	Immunoglobulin superfamily protein in epithelial cells
Herpes simplex virus	Immunoglobulin superfamily protein in many cells
Rabies virus	Acetylcholine receptor in neuron
Influenza A virus	Sialic acid in epithelial cells
Parvovirus B19	Erythrocyte P antigen in erythroid precursors

## Penetration

Depending on their nature, whether enveloped or nonenveloped, the viruses penetrate into cell by different mechanisms:

- A **nonenveloped virus** enters the cell by a process known as *endocytosis*. The endocytosis is an active process by which nutrients and other molecules are brought into a cell. This process is also known as *viropexis*.
- The **enveloped viruses** enter the cell by an alternate method called *fusion*, in which the viral envelope fuses with the plasma membrane and releases the capsid into the cell cytoplasm. Human immunodeficiency virus (HIV) is a classical example of an enveloped virus, which enters the host cell by this method.

## Uncoating

Uncoating is the process of separation of viral nucleic acid from its protein core. This process apparently varies depending on the nature of the virus causing infection:

- With most viruses, the uncoating is accomplished by the action of lysosomal enzymes present inside the phagocytic vacuoles and Golgi vesicles of the host cell. These lysosomal enzymes degrade the protein of the viral capsid.
- In some other viruses, uncoating is caused exclusively by enzymes present in the host cell cytoplasm. In case of poxvirus, the uncoating is effected by the action of a specific enzyme encoded by the viral DNA, which is synthesized soon after infection.

## Biosynthesis

The sites of viral synthesis depend on the type of virus, whether RNA virus or DNA virus.

### ► Biosynthesis of DNA viruses

DNA viruses replicate their DNA in the nucleus of the host cell by using viral enzymes. However, they synthesize their capsid and other proteins in the cytoplasm by using host cell enzymes. Subsequently, the proteins enter into the nucleus and assemble with the newly synthesized DNA to form virions, and then these virions are transported along with endoplasmic reticulum to the membrane of the host cell for release. Most of the DNA viruses (herpesvirus, papovavirus, adenovirus, and hepadnavirus) synthesize their nucleic acid in the host cell nucleus. Poxvirus is an exception, because all of its components are synthesized in the cytoplasm.

### ► Biosynthesis of RNA viruses

The RNA viruses multiply in the cytoplasm of the host cell. The major differences among the multiplication process of various RNA viruses lie in how mRNA and viral RNA are produced, as follows:

1. In Reoviruses, the double-stranded RNA is transcribed to mRNA by viral polymerase.
2. Single-stranded RNA viruses are classified into two categories, depending on the method of mRNA transcription. In positive strand (+ strand, positive sense) RNA virus, the viral RNA itself acts as the mRNA. The viral RNA is translated directly into viral proteins in host cell cytoplasm. In the negative strand (–sense) RNA viruses, the RNA is anti-sense, with polarity opposite to that of mRNA. They possess their own RNA polymerase for transcription of mRNA.
3. The single-stranded RNA genome of Retroviridae shows a unique replication. First, the RNA genome is converted into an RNA–DNA hybrid by the viral enzyme reverse transcriptase (RNA-directed DNA polymerase). The double-stranded DNA is synthesized from the RNA–DNA hybrid, after which it is integrated into the host cell chromosome. Integration of viral DNA into the host cell may lead to transformation of the cell and development of malignancies.

## Maturation

The assembly of the protein capsid is the first step in viral maturation. The capsids of many enveloped viruses, such as orthomyxoviruses and paramyxoviruses are enclosed by

envelopes, which consist of proteins, lipids, and carbohydrates. During maturation, the envelope protein is encoded by the viral genes and is incorporated into the plasma membrane of the infected host cell. In contrast, the envelope lipids and carbohydrates are encoded by host cell genes, but not by viral genes, and are present in the plasma membrane. The envelope develops around the capsid by a process called *budding*.

The assembly of various viral components into virions may take place in the nucleus (e.g., herpesvirus and adenoviruses) or cytoplasm (e.g., picornaviruses and poxviruses).

The nonenveloped viruses are present intracellularly as fully developed viruses, but in case of enveloped viruses, only the nucleocapsid is complete. Subsequently, nucleocapsid is surrounded by an envelope, which is derived from the host cell membrane during the process of budding.

## Release

Release of the completed viruses is the last step in the replication of viruses.

- In case of animal viruses, the release of progeny virions usually occurs without cell lysis. The host cell is unaffected and goes on dividing to the daughter cells, which continue to release virions. Progeny virions are released into the surrounding environment and may affect new host cells. Budding does not immediately kill the host cell and in some cases the host cell survives.
- Nonenveloped viruses, however, release through rupture in the host cell plasma membrane. This type of release usually results in the death of the host cell.

A single infected cell may release a large number of daughter virions. The time taken for a single cycle of replication is about 15–30 hours. In a cycle of replication, the virus cannot be demonstrated inside the host cell from the stage of penetration till the appearance of mature daughter virions. This period is known as the *eclipse stage*.

## Abnormal Replicative Cycles

During replicative cycles of virus, many types of abnormal replicative cycle do occur. These are as follows:

**Incomplete viruses:** Due to defect during assembly of viral components, some of the daughter virions that are produced may not be infective. Example of such incomplete virus is the influenza virus that shows a high hemagglutination titer but with a low infectivity. This is known as von Magnus phenomenon.

**Pseudovirions:** Pseudovirions are the viruses that occasionally enclose host cell nucleic acid instead of viral nucleic acid. These, therefore, are noninfective and lack the capability to replicate.

**Abortive infections:** In this type of infection, the virus components may be synthesized but the maturation is defective. The progeny virions are either not released or are noninfectious. This type of infection occurs due to infection of the wrong host cells by the virus.

**Defective viruses:** Some of the viruses that are genetically defective do not produce fully formed virions. They produce fully mature virions only in the presence of helper viruses which supplement the genetic deficiency in the defective viruses. Hepatitis D virus and adeno-associated satellite viruses are the examples of defective viruses, which replicate only in the presence of helper viruses, such as hepatitis B virus and adenovirus, respectively.

## Viral Genetics

The viruses are obligate intracellular pathogens. They replicate only in a living host cell. Viruses, like other living beings, obey the law of genetics. The viruses show variation in their genomic structure by two principal methods—mutations and recombination.

## Mutation

Mutation is the most important mechanism of genetic modification in viruses. Mutations occur spontaneously and readily in viral genomes causing frequent changes in the nucleic acids. This results in production of new viral strains showing properties different from parental or wild-type virus. Mutations occur during every viral infection; the frequency of mutations being about  $10^{-4}$  to  $10^{-5}$ . New variants of strains are identified by their nucleotide sequence, antigenic differences, or by differences in their structural or functional properties. Mutations in the essential genes of virus cause inactivation of the virus. This is known as *lethal mutation*. However, mutations in the other genes alter antigenicity and pathogenicity of the virus and induce drug resistance in viruses. Mutations in viruses may be induced by mutagens, e.g., irradiation or chemical agents, such as 5-fluorouracil, or even may occur spontaneously.

### ▶ Lethal mutations

Mutations in essential genes are known as lethal mutations. Mutations in viruses lead to formation of various mutants, which show new functional or structural proteins. This leads to formation of new viral mutants, which are difficult to isolate because the virus cannot replicate. Selective removal or loss of a portion of the viral genome and subsequent loss of function that it encodes leads to the formation of deletion mutant. Other mutations may produce:

- **Attenuated emutants**—variant strains that cause less serious infections in humans and animals.
- **Host range mutants**—variant strains showing differences in the tissue type and species of target cells affected by viruses.
- **Plaque mutants**—variant strains showing difference in their size or their appearance in infected host cells.
- **Conditional mutants**—e.g., temperature-sensitive or cold-sensitive mutants.

## Key Points

**Temperature-sensitive mutants** can grow only at a low temperature (28–37°C). This is due to a mutation in the gene for an essential protein that allows viral replication only at low temperature. These temperature-sensitive mutants are used extensively for the study of viral genetics and are also evaluated for possible use in live viral vaccines.

## Recombination

Genetic recombination may occur when two different but related viruses infect a cell simultaneously. This leads to extramolecular genetic exchange between two viruses, leading to production of a progeny virion that possesses genes from both the viruses. Genetic recombination may occur between (a) two active infectious viruses, (b) one active and another inactive virus, and (c) two inactive viruses. Following types of genetic recombination may occur when a host cell is affected by two viruses:

1. Intramolecular recombination
2. Reassortment
3. Reactivation

### ▶ Intramolecular recombination

Intramolecular recombination occurs between two closely related DNA viruses. For example, infection of the host cell by two closely related herpesviruses, such as herpes simplex virus type 1 and 2 produces recombinant, new hybrid strains. These new hybrid strains possess genes from both viruses: type 1 and 2. This process has also been observed in closely related RNA viruses. For example, recombination of Sindbis and eastern equine encephalitis virus has led to the formation of western equine encephalitis virus, another togavirus.

### ▶ Reassortment

Reassortment is another process of genetic recombination. It occurs between viruses with segmented genomes, such as influenza virus A and B (8 segments), Reoviridae (10–12 segments), Bunyaviridae (3 segments), and Arenaviridae and Birnaviridae (2 segments). An exchange of segments occurs between these viruses, resulting in production of new hybrid strains. Synthesis of new strains of influenza A by coinfection with a virus from different species is an example of genetic recombination by reassortment that occurs in nature.

### ▶ Reactivation

It is of two types: (a) cross-reactivation or marker rescue and (b) multiplicity reactivation.

**Cross-reactivation (marker rescue):** This occurs between an active virus and a related inactive virus, resulting in

a progeny possessing one or more genetic traits of the inactivated virus. For example, in influenza virus, when a new epidemic strain (e.g., strain A1) that does not often grow well in eggs as compared to the established strain is grown in eggs along with a standard strain (e.g., strain A2) inactivated by UV irradiation, it results in production of a new hybrid strain. The hybrid strain may have antigenic properties of strain A2 but genetic characteristics of A1. Such viruses have been evaluated widely in production of influenza vaccines. Marker rescue is also used to map the genome of herpes simplex virus.

**Multiplicity reactivation:** This is a phenomenon in which live virus may be produced when a cell is infected with two or more (high multiplicity) virus particles of the same virus, each of which has suffered lethal mutation in a different gene due to UV irradiation. Thus from the total genetic pool, it may be possible to obtain a full complement of undamaged genes, resulting in production of infectious virion progeny. Therefore, there is a potential danger of multiplicity reactivation occurring following the administration of UV-irradiated vaccine. So UV irradiation is not a safe method of producing inactivated virus vaccine.

## Nongenetic Interaction between Viral Gene Products

Nongenetic interaction between viral gene products takes place in following four ways: (a) complementation, (b) phenotypic mixing, (c) genotype mixing, and (d) interference.

### ▶ Complementation

Complementation is a functional interaction between the gene products of two viruses, when two viruses (one or both of which may be infective) infect a cell simultaneously. In this process, their gene products, such as proteins and enzymes, complement action of each other so as to have increased yield of one or both viruses. This occurs even between unrelated viruses. In this process, a defective virus strain can be rescued by the replication of another mutant or by a wild-type strain. For example, adenovirus is defective in simian cell but it can be rescued by SV40. The SV40 virus can grow in monkey cells and produce a gene product that adenovirus needs, thereby complementing replication of adenovirus.

### ▶ Phenotypic mixing

In this process, virus products from cells infected with different virus strains may be phenotypically mixed and have the properties of one strain but the genome of other. This is not a stable variation; on subsequent passage, the capsid will be found to be of the original type only. In phenotypic mixing, when the nucleic acid of one virus is surrounded by the entire capsid of the other virus, it is called *transcapsidation*. Pseudotypes are produced when transcapsidation occurs between different types of viruses, but this is rare.

## ► Genotypic mixing

All the viruses of vertebrates are haploid except retroviruses which are diploid; but sometimes several nucleocapsids may be enclosed within a single envelope. This phenomenon of genotypic mixing is known as *polyplody*. No recombination between the genomes of the virus takes place, and it is not a stable change.

## ► Interference

Interference denotes inhibition of growth of one virus in a host cell when it is simultaneously infected with another virus. Interferon is the most important mediator of interference. Autointerference is another type of interference, in which a high multiplicity of infection inhibits production of infectious progeny. In contrast, mixed infections sometimes increase the yield of one virus and produce well-marked cytopathic effects in the cell lines. This phenomenon is called *enhancement*.

## Nomenclature and Taxonomy of Viruses

The initial classification of viruses was haphazard and was based on the symptomatology of the disease they caused or on the sites of their isolation. They were classified as (a) pneumotropic, those affecting the respiratory tract (e.g., influenza and common cold); (b) neurotrophic, affecting the nervous system (e.g., poliomyelitis and rabies); (c) dermatotropic, affecting the skin (e.g., smallpox and chickenpox); and (d) viscerotropic, affecting visceral organs (e.g., hepatitis, yellow fever). This system of classification was convenient but not scientifically acceptable, because the same virus may cause more than one disease depending on the tissue affected.

Since 1966, a systematic classification of viral taxonomy and nomenclature was carried out with the formation of International Committee on the Taxonomy of Viruses (ICTV). Since then, ICTV has been introducing systematic approach for classification and nomenclature of the viruses. The ICTV has been grouping viruses into families based on (a) type of nucleic acid they possess, (b) means of replication, and (c) morphology (e.g., presence or absence of membrane envelope).

The suffix *virus* is used for genus names, *viridae* for family names, and *ales* for order names. In formal usage, the family and genus names are used in the following manner: for example, family Rhabdoviridae, genus *Lyssavirus*, human rabies virus. A viral species is a group of virus that shares the same genetic information and ecological niche. These viral species are designated by descriptive common names, such as human herpesvirus, with subspecies, if any, designated by a number (e.g., HHV-1).

Depending on the type of nucleic acids viruses possess, they are classified into two groups: deoxyriboviruses, which contain DNA (DNA virus) and riboviruses, which contain RNA (RNA virus). DNA viruses associated with human diseases are divided into six families (Table 50-6). The RNA viruses associated with human diseases are classified into at least 13 families (Table 50-7).

## DNA Viruses

These belong to the following families (Table 50-6):

**Adenoviridae:** The members of the family Adenoviridae are medium-sized viruses measuring 20–90 nm in size. These viruses are nonenveloped, icosahedral viruses with 252 capsomeres. They are so named because they were first isolated from adenoids. These viruses are mostly associated with acute respiratory diseases.

**Poxviridae:** These are large-sized, brick-shaped viruses measuring  $300 \times 240 \times 100 \mu$  in size. They have a complex structure with a core containing a single linear molecule of double-stranded DNA genome. The pox (*pox*: pus-filled lesions) viruses are associated with skin lesions. The viral components are synthesized and assembled in the cytoplasm of infected host cells.

**Herpesviridae:** These are medium-sized icosahedral nucleocapsid viruses (100 nm) containing 162 capsomeres. They are enveloped viruses containing linear, double-stranded DNA. They are named after spreading (herpetic) appearance of cold sores. The viruses multiply in the nucleus of the host cells.

**Papovaviridae:** These are small (40–55 nm) viruses containing double-stranded DNA with 72 capsomeres. They are nonenveloped viruses. They replicate in the nucleus of host cell along with host cell chromosome. This may cause host cells to proliferate, resulting in a tumor. Papovaviruses are acronyms to papillomas (warts), polyomas (tumors), and vacuolation (cytoplasmic vacuolation produced by some of these viruses).

**Hepadnaviridae:** Hepadnaviridae (*hepa*: liver; *dna*: DNA core) are so named because they cause hepatitis and contain DNA as genome. These viruses differ from other DNA viruses by synthesizing their DNA by copying RNA using reverse transcriptase. Human hepatitis B virus, an important virus associated with human disease, is included in this family.

## RNA Viruses

These belong to the following families (Table 50-7):

**Togaviridae:** These viruses include arboviruses and alphaviruses. Most of these viruses multiply in arthropods as well as in vertebrates. Togaviridae (*toga*: envelope) are enveloped viruses containing single-stranded RNA genome. These viruses are small spherical viruses measuring 40–70 nm in size.

**Rhabdoviridae:** Rhabdoviruses (*rhabdo*: rod) are bullet-shaped viruses. They are enveloped, measure  $130\text{--}300 \times 20$  nm in size, and contain a single-stranded RNA.

**Reoviridae:** They are icosahedral, nonenveloped viruses measuring 60–80 nm in size. They contain double-layered capsid enclosing 10–12 segments of double-stranded RNA. Their name is derived from the first letters of respiratory, enteric, and orphan. When first discovered, the viruses were not associated with any diseases, hence were called orphan viruses. These viruses are now known to cause respiratory and intestinal infections.

TABLE 50-6

Properties of human DNA viruses

Family	Genera (Members)	Shape	Size (nm)	Molecular mass $\times 10^6$ Da	Nature
<b>Poxviridae</b>	<i>Orthopoxvirus</i> (smallpox virus and vaccinia virus), <i>molluscipoxvirus</i> (Molluscum contagiosum)	Brick shaped, enveloped	300 $\times$ 240 $\times$ 100	85–140	Double stranded, linear
<b>Herpesviridae</b>	<i>Herpes simplex virus</i> (herpes simplex virus types 1 and 2), <i>Varicellovirus</i> (varicella zoster virus), <i>Lymphocryptovirus</i> (Epstein–Barr virus), <i>Cytomegalovirus</i> (human cytomegalovirus) <i>Roseolovirus</i> (HHV-6 and -7), <i>Rhadinovirus</i> (Kaposi's sarcoma-associated herpes virus)	Icosahedral, enveloped	Capsid: 100–100 Envelope: 120–200	100–150	Double stranded, linear Presence of terminal and internal reiterated sequences
<b>Adenoviridae</b>	<i>Mastadenovirus</i> (adenovirus)	Icosahedral cubic symmetry with 252 capsomeres. Fibres protrude from the vertex capsomeres.	70–90	20–25	Double stranded, linear
<b>Hepadnaviridae</b>	<i>Hepadnavirus</i> (hepatitis B virus)	Spherical, enveloped	42	1.8	Double stranded, circular, virion carries a DNA polymerase able to make fully double-stranded molecules
<b>Papovaviridae</b>	<i>Papillomavirus</i> (human papillomavirus) and <i>polyomavirus</i> (JC virus, BK virus, and SV40)	Icosahedral	45–55	3–5	Double stranded, circular
<b>Parvoviridae</b>	<i>Erythrovirus</i> (parvovirus B19) and <i>dependovirus</i> (adeno-associated virus)	Icosahedral Cubic symmetry and 32 capsomeres	18–26	1.5–2	Single stranded, linear, and double stranded

**Retroviridae:** Retroviruses (*re*: reverse, *tr*: transcriptase) viruses are so named because characteristically they possess the enzyme, reverse transcriptase RNA-dependent DNA polymerase. They are icosahedral, enveloped viruses measuring 100 nm in size. Many of these viruses are associated with tumors in infected hosts. One of the genera, Lentivirus includes the subspecies HIV-1 and HIV-2, the causative agents of acquired immunodeficiency syndrome (AIDS).

**Picornaviridae:** Picornaviruses (*pico*: small) are the smallest viruses, measuring 20–30 nm in size. They are nonenveloped, icosahedral viruses with single-stranded RNA genome. These include three genera (Enterovirus, Rhinovirus, and Hepatovirus) of medical importance.

**Orthomyxoviridae:** These are medium-sized (80–120 nm) viruses. They are spherical and elongated, enveloped viruses consisting of single-stranded but segmented (eight segments) RNA genome. Influenza virus is the only virus of medical importance belonging to this group.

**Paramyxoviridae:** These are pleomorphic, enveloped viruses measuring 150 nm in size. They contain nonsegmented,

single-stranded, linear RNA. Three genera have been described: Paramyxovirus, Morbillivirus, and Pneumovirus.

**Bunyaviridae:** These are enveloped, spherical viruses measuring 90–100 nm in size. The genera of medical importance include Bunyavirus, Hantavirus, Uukuvirus, Phlebovirus, and Nairovirus.

**Arenaviridae:** They are spherical, pleomorphic viruses with variable sizes (50–300 nm). They contain electron-dense, chromosome-like particles giving a sandy appearance; hence they are named arenaviruses (*arena*: sand).

**Calciviridae:** These are naked nonenveloped viruses. They are small and spherical, and measure 35–39 nm in size. They show 32 cup-shaped depressions arranged in symmetry.

**Filoviridae:** They are long filamentous, enveloped viruses with variable sizes. They contain single-stranded RNA genome. The Marburg and Ebola virus are the viruses of medical importance.

## Prions

Prions are infectious particles, which can transmit a disease. These prions are composed chiefly a protein without any detectable nucleic acid. This is a new name widely accepted for the old

TABLE 50-7

## Properties of human RNA viruses

Family	Genera (Members)	Shape	Size (nm)	Molecular mass $\times 10^6$ Da	Nature
<b>Paramyxoviridae</b>	<i>Respirovirus</i> (Sendai virus, human parainfluenza virus types 1 and 3), <i>Rubulavirus</i> (mumps virus), <i>Morbillivirus</i> (measles virus), and <i>pneumovirus</i> (human respiratory syncytial virus)	Spherical	150–300	5–7	Single stranded, linear, negative sense, and nonsegmented
<b>Orthomyxoviridae</b>	<i>Influenzavirus A</i> (human influenza A virus), <i>Influenzavirus B</i> (human influenza B virus), and <i>Influenzavirus C</i> (human influenza C virus)	Spherical	80–120	5	Single stranded, segmented, linear negative sense.
<b>Coronaviridae</b>	<i>Coronavirus</i> (coronavirus)	Spherical	80–130	6	Single stranded, unsegmented positive-sense RNA
<b>Arenaviridae</b>	<i>Arenavirus</i> (Lassa fever virus, Junin and Machupoviruses, lymphocytic choriomeningitis virus)	Spherical	50–300	3–5	Single stranded, segmented, circular, and negative-sense
<b>Rhabdoviridae</b>	<i>Vesiculovirus</i> (vesicular stomatitis virus) and <i>Lyssavirus</i> (rabies virus)	Bullet shaped	180 $\times$ 75	4	Single stranded, nonsegmented negative-sense RNA
<b>Filoviridae</b>	<i>Filovirus</i> (Ebola virus and Marburg virus)	Filamentous	800 $\times$ 80	4	Single stranded
<b>Bunyaviridae</b>	<i>Orthobunyavirus</i> (California encephalitis virus and La Crosse virus), <i>Phlebovirus</i> (sandfly fever virus), and <i>Hantavirus</i> (Hantaan virus)	Spherical	90–100	4–7	Single stranded
<b>Retroviridae</b>	<i>Deltaretroviruses</i> (human T-cell leukemia virus types I and II), <i>lentiviruses</i> (human immunodeficiency virus), <i>alpharetroviruses</i> , <i>betaretroviruses</i> , <i>gammaretroviruses</i> , and <i>epsilon retroviruses</i>	Spherical	80–110	2 $\times$ (2–3)	Single stranded
<b>Reoviridae</b>	<i>Rotavirus</i> (rotavirus), <i>orbivirus</i> (Colorado tick fever virus), and <i>orthoreovirus</i>	Icosahedral	60–80	11–15	Double stranded, segmented
<b>Picornaviridae</b>	<i>Enterovirus</i> (poliovirus, echovirus, Coxsackie virus), <i>rhinovirus</i> (human rhinovirus), and <i>hepatovirus</i> (human hepatitis A virus)	Icosahedral	25–30	2.5	Single stranded and positive sense
<b>Togaviridae</b>	<i>Rubivirus</i> (rubella virus) and <i>alphavirus</i> (Western, Eastern, and Venezuelan equine encephalitis virus, Ross River virus, Sindbis virus, and Semliki forest virus)	Icosahedral	60–70	4	Single stranded
<b>Flaviviridae</b>	<i>Flavivirus</i> (yellow fever virus, dengue virus, and St. Louis encephalitis virus), <i>pestivirus</i> , and <i>hepatitis C virus</i> (human hepatitis C virus)	Spherical	40–50	4	Single stranded
<b>Calciviridae</b>	<i>Norovirus</i> (Norwalk virus), <i>sapovirus</i> (Sapporo virus), <i>lagovirus</i> , and <i>vesivirus</i>	Icosahedral	35–40	2.6	Single stranded

name slow viruses. The term prion was coined by Prusiner for proteinaceous infectious particles. Unlike conventional viruses, the prions apparently have no virion structure or genomes and evoke no immune response in the infected host. These are extremely resistant to inactivation by heat, disinfectants, and radiation.

The prions are causative agents of slow viral infections, such as subacute spongiform encephalopathy. After long incubation period of years, they produce a progressive disease that causes damage to the central nervous system, leading to subacute spongiform encephalopathy. The detailed description of prions and slow virus diseases is provided in Chapter 69.

## Viroids

Viroids are protein-free fragments of single-stranded, circular RNA that cause disease in plants. The term viroids was coined by Triener (1971) to describe a new subclass of subviral agents having a genome very much similar to those of known viruses; they consist of very short pieces of naked RNA: 300–400-nucleotides long with no protein coat. The RNA does not code for any proteins. The low-molecular-weight RNA is resistant to heat and organic solvents but sensitive to nucleases. So far, viroids have been identified as pathogens of only plants; these were first identified in the potato spindle tuber disease. The viroids are yet to be linked to any disease in humans.

# Pathogenesis of Viral Infections

## Introduction

Viruses cause infection of the host first by breaking the natural protective mechanisms of the body, then evading the immune system of the host, and finally by killing off the host cells and triggering immune and inflammatory responses. The outcome of viral infection depends upon response of the host to infection by a virus and on the nature of the host–virus interaction. Viruses replicate only inside the living cells; hence, the primary pathogenic manifestations are seen at the cellular level.

## Stages of Viral Infections

Viruses initiate infection and may cause disease through many defined stages. These include (a) entry into the body, (b) initiation of infection at a primary site (infection of the target tissue),

(c) replication of virus (Fig. 51-1) and spread to secondary site, and (d) manifestations of the disease.

## Entry into the Body

Entry of the viruses into the body is the first step of viral infections. The skin is the best barrier to infections. In addition to the skin, mucus, ciliated epithelium, gastric acid, bile, tears, etc. confer basic natural protection against many viruses. The viruses enter the body through the respiratory tract, skin, conjunctiva, alimentary tract, and genital tract to initiate the infection by breaking these natural barriers to infection.

### ► Respiratory tract

Many viral infections are caused by entry of virus through the respiratory tract. The viruses enter the respiratory tract by droplets containing the viruses expelled from the nose and

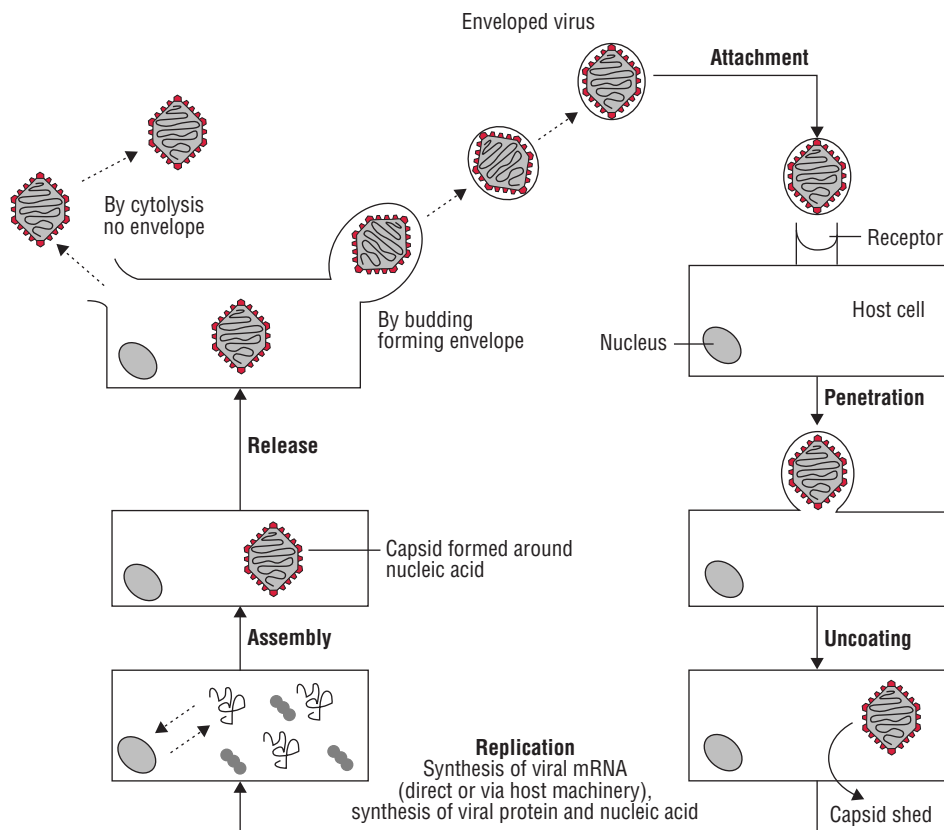

FIG. 51-1. Replication cycle of viruses.



mouth of infected individuals during the act of coughing, sneezing, or talking.

- Some viruses, after entry into body, are confined to the respiratory tract where they multiply and produce local diseases. These are known as respiratory viruses. Examples of these viruses are influenza virus, respiratory syncytial virus, rhinovirus, coronavirus, adenovirus, and Cocksackie virus A.
- Other viruses after entry, initially multiply at the site of respiratory tract followed by hematogenous or lymphatic spread to other sites of the body. At these sites, the viruses replicate in large numbers and cause systemic manifestations of the disease. The examples of such viruses include measles, mumps, rubella, varicella zoster, cytomegalovirus, and Epstein–Barr virus.

### ► Skin

Many viruses enter the skin through abrasions or breaks in the skin. Molluscum contagiosum, cowpox, vaccinia, and variola viruses enter the skin through minor lesions and produce cutaneous lesions at the site of entry. Other viruses, such as papilloma virus, enter the skin through minor injuries on the surface of skin, arboviruses by bite of insects, rabies virus by the bite of dogs and other animals, and hepatitis B virus and human immunodeficiency virus (HIV) by injection.

### ► Conjunctiva

Some viruses may enter through the conjunctiva and may cause the disease. For example, adenovirus causes local manifestations and measles virus causes systemic manifestation of the disease by entering through the conjunctiva.

### ► Alimentary tract

The viruses also cause infection by entering through the alimentary tract, which is another important route of infection by viruses. The viruses, such as rotaviruses, enteroviruses, adenoviruses, reoviruses, hepatitis viruses, and other gastrointestinal viruses cause infections of the gastrointestinal tract and produce disease.

Rotaviruses, on ingestion, are carried to the intestinal tract in which they initiate the infection. Rotavirus is restricted to the gut, producing a local disease. Other viruses, such as enteroviruses, adenoviruses, reoviruses, and hepatitis viruses, on the other hand, initiate infections through the alimentary tract, replicate locally, and then are transported to other sites for subsequent replication and spread to target tissues, producing systemic manifestations of the diseases.

Natural barriers against viral infections include (a) the acidity of the stomach, (b) the alkalinity of the small intestine, and (c) secretory enzymes found in the saliva and pancreatic secretions. Intestinal mucus and secretory IgA antibodies are important and offer partial protection to the intestinal tract. Enveloped viruses usually fail to establish infection in the gastrointestinal tract, because these are destroyed by bile secreted in the gastrointestinal tract.

### ► Genital tract

Viruses are also transmitted through sexual contact and enter the body through the genital tract.

- HIV, hepatitis B virus, and hepatitis C virus are sexually transmitted and do not produce any local lesions in the genital tract but produce systemic manifestations.
- Papilloma viruses and herpes simplex viruses (HSVs) are also transmitted sexually and produce lesions locally in the genital tract and perineum.

### ► Congenital infections

Few viruses may cause congenital infection in fetus *in utero* being transmitted from the infected mother. Rubella and cytomegaloviruses are the viruses that are more commonly associated with congenital infections. Depending upon the age of the fetus, these viruses may cause malformations or even fetal death and abortion.

## Initiation of Infection at Primary Site (Infection of the Target Tissue)

The viruses, on entry into the human host, may remain at the primary site of infection, replicate, and cause infection of the target tissue. The specificity of the virus-attachment proteins and tissue-specific expression of receptors during replication are two important properties of viruses to cause infection of target tissues.

### Key Points

- Many viruses cause infection in the oral mucosa or upper respiratory tract. Replication of viruses at the primary sites may be accompanied by clinical symptoms.
- Some viruses, on the other hand, may disseminate to other tissues through blood stream, lymphatic system, and neurons (secondary sites) and cause a systemic infection.

## Replication of Virus and Spread to Secondary Site

The viruses are spread in the body mainly by the blood stream and the lymphatic system. Transport of virus in the blood is known as *viremia*. After multiplication in the lymph nodes, the virus enters the blood stream, resulting in *primary viremia*. In the blood stream, the virus may exist either free in the plasma or it may be ingested by the lymphocytes or macrophages. In macrophages, the viruses may die or replicate or may be carried by the mononuclear phagocytic system to the spleen and liver. Replication of the viruses in macrophages, in the endothelial lining of blood vessels, or in the spleen and liver results in production of viruses in large numbers. This leads to massive spillover of the virus into the blood stream, causing *secondary viremia*. This heralds the onset of clinical symptoms of viral infections including the prodromal phase in eruptive

fever. Subsequently, it is carried by blood stream to reach target organs (skin, brain, liver, etc.) in which the viruses replicate producing characteristic distinctive lesions.

Viruses enter the brain or central nervous system (a) through the blood stream, (b) through the infected cerebrospinal fluid or meninges, and/or (c) through the infection of the peripheral and sensory (olfactory) neurons.

## Manifestations of the Viral Diseases

The clinical manifestations of viral diseases depend on the complex interaction of virus and host factors. The outcome of the infection, that is, the disease manifestation depends on the:

- Age, general health, and immune status of the person,
- Dose of the infective virus, and
- Genetics of the host and the virus. After the host is infected by the virus, the immune status of the host plays an important role and determines the outcome of viral infection whether it will be an asymptomatic infection, a benign disease, or a life-threatening disease.

## Viral Pathogenesis at the Cellular Level

The host cells show a variety of different responses to viral infection depending on the virus causing the infection and type of the cell infected. Moreover, the outcome of infection is determined by the properties of the virus and the cell. The host cells may be (a) permissive, (b) semipermissive, and (c) nonpermissive.

- A **permissive cell** is a cell that allows replication of a particular type of strain of virus by providing biosynthesis compounds, such as transcriptional factors and posttranslational enzymes.
- A **nonpermissive cell** does not provide any biosynthesis compound, hence does not support replication of the viruses.
- A **semipermissive cell** may support some but not all the stages in viral infection.

Replication of virus in cell may cause a broad spectrum of effects, ranging from nonapparent cellular damage to rapid cell destruction.

- Some viruses may cause cell death or even cell lysis. For example, polioviruses cause death of cells (*cytotoxic effect*) and even lysis of the cells (*cytolysis*), molluscum contagiosum cause proliferation of cells, and oncogenic viruses cause malignant *transformation of cells*.
- Some other viruses may cause alterations in cells' morphology, functional properties, malignant transformation, or antigenicity (Table 51-1).
- In some conditions, viruses infect cells and replicate independently within the cells without causing any cellular injury to the infected cells. This is known as *steady state infection*.
- In cell cultures, the virus produces demonstrable cellular changes in the infected cells known as *cytopathic effects* (CPEs).

TABLE 51-1

Cytopathic effects of viruses

Viruses	Cytopathic effects
Enterovirus	Cell death
Measles virus	Cell fusion
Polyoma virus	Transformation
HIV	Destruction of T cells
Adenovirus	Inclusion bodies in nucleus
Papovavirus	Inclusion bodies in nucleus
Rabies virus	Inclusion bodies in cytoplasm (negri bodies)
Cytomegalovirus	Inclusion bodies in cytoplasm and nucleus

The cellular changes produced by the virus may be due to many factors. These cellular changes may be caused (a) by viral takeover of macromolecular synthesis of proteins and enzymes by viruses instead of host cell, (b) by accumulation of virus proteins or particles, or (c) by alteration or disruption of cellular structure.

Production of early or nonstructured viral proteins often inhibits the production of host protein and synthesis of host DNA. The accumulation of large amounts of viral proteins or particles in the infected cells may lead to the modification or disruption of the cellular architecture.

At the cellular level, depending on the nature of the virus and the cell infected, the virus infection in a cell can produce any of the three infections (Fig. 51-2):

1. Failed infection (abortive infection)
2. Cell death (lytic infection)
3. Infection without cell death (persistent viral infection)

## Abortive Infection

Some viruses cause failed or abortive infections in which those viruses do not multiply, therefore disappear from the cell.

## Lytic Infection

Some viruses cause cell death or lytic infection. This occurs due to replication of virus in infected cell, which kills the target cell. The cellular injury caused by viruses may be due to combination of several factors. Viruses adopt different mechanisms (Table 51-2) for preventing cellular growth and causing cell death as follows:

### ► Inhibition of cellular protein synthesis

HSV, poliovirus, togaviruses, and poxviruses cause cell death by inhibition of cellular protein synthesis. These viruses during replication produce proteins that inhibit synthesis of cellular DNA and/or RNA. These viruses also produce other proteins, which break down host cellular DNA to components that serve as substrates for replication of viral genome. The accumulation

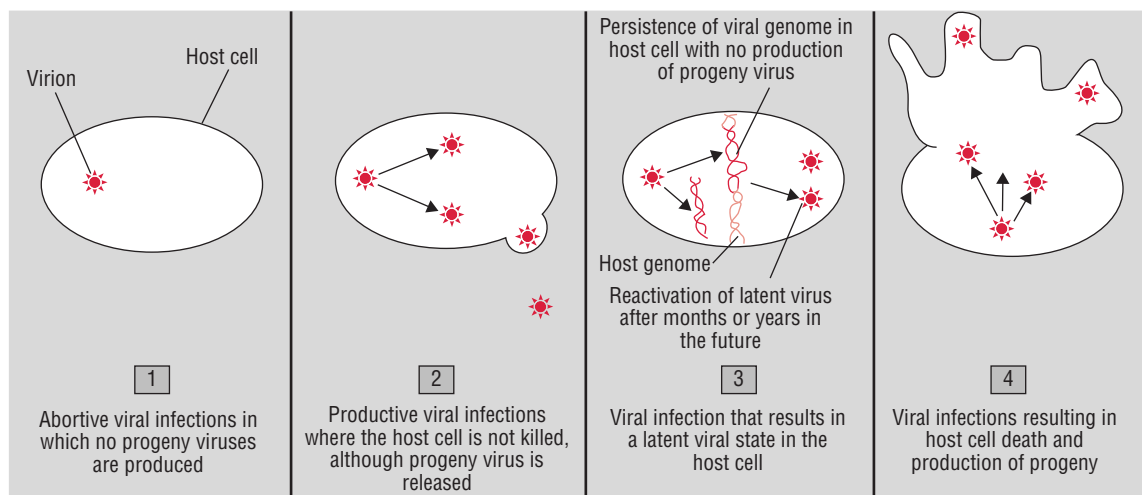

FIG. 51-2. Viral infection at the cellular level.

TABLE 51-2

### Mechanisms of cytopathogenesis of viral infections

Viruses	Mechanisms of cytopathogenesis
Herpes simplex virus, varicella zoster virus, paramyxovirus, and human immunodeficiency virus	Alteration of cell membrane by syncytia formation
Nonenveloped viruses	Alteration of cell membrane by disruption of cytoskeleton
Togaviruses, and herpes virus	Alteration of cell membrane by permeability
Adenovirus	Toxicity of virion components
Poliovirus, herpes simplex virus, togavirus, and poxvirus	Inhibition of cellular protein synthesis
Herpes viruses	Inhibition of degradation of cellular DNA
Rabies, and cytomegalovirus	Accumulation of viral proteins and structures (inclusion bodies) in the cytoplasm or nucleus

of large amounts of viral macromolecules and viral progeny in infected cells during viral replication may disrupt the cellular structure or functions of the cell, or disrupt lysosomes causing autolysis.

#### ► Cell fusion

Infections of cells with certain viruses cause the cells to fuse, resulting in the production of giant multinucleated cells. Infection by paramyxoviruses, herpes viruses, and retroviruses results in the expression of glycoproteins on the cell surface. This triggers the fusion of neighboring cells, resulting in the formation of large multinucleated giant cells called syncytia. Formation of syncytia facilitates spread of the virus from cell-to-cell and allows the virus to escape from the lytic effect of antibodies. The cell-to-cell fusion of infected cells is of two types:

- 1. Fusion from without:** In this type, cell fusion occurs in the absence of new protein synthesis (e.g., Sendai viruses and other paramyxoviruses).
- 2. Fusion from within:** In this type, cell fusion requires new protein synthesis (e.g., HSV).

Infection by viruses causes a variety of changes in infected cells as follows:

- Certain viruses cause alterations in the cytoplasm of infected cells, or lead to expression of virus-coded antigens on the surface of infected cells. For example, respiratory syncytial virus causes fusion of adjacent cell membrane, resulting in polykaryocytosis or formation of syncytia.
- The infected cell may confer new properties on the cells. For example, infection by influenza virus results in the appearance of viral hemagglutinin on infected cell surfaces, leading to hemadsorption or adsorption of erythrocytes to the cell surface. Some viruses cause *apoptosis* in the infected cells. Apoptosis is a process leading to cellular suicide that facilitates the release of viruses from the cell.
- Certain viral infections produce characteristic changes in the properties and appearance of target cells. For example, measles viruses, mumps viruses, adenoviruses, cytomegaloviruses, and varicella viruses cause chromosomal aberrations and degradations. Infection by adenovirus types 12 and 31 and HSV cause marginated chromatin ring in the nuclear membrane.

#### ► Transformation

Transformation is an irreversible genetic process caused by the integration of viral DNA with the DNA of the host cell. Infection of cells with certain viruses causes transformation of normal cells to malignant cells. The viruses that stimulate uncontrolled cell growth causing the transformation of immortalization of the cell are known as *oncogenic viruses*.

Different oncogenic viruses cause transformation or immortalization of the cells by different mechanisms as follows: (a) they promote or provide growth-stimulating genes, (b) they prevent apoptosis, and (c) they bring in mechanisms that limit DNA synthesis and cell growth.

The DNA oncogenic viruses infect semipermissive cells, which express only selected viral genes but do not produce complete virus.

### Key Points

- Most oncogenic DNA viruses integrate with host cell chromosome during transformation. For example, Epstein–Barr virus causes transformation of the cells by stimulating cell growth and inducing the expression of an oncogene (cell's bcl-2 oncogene) that prevents apoptosis or programmed cell death.
- Other viruses, such as adenovirus, papilloma virus, and SV40 induce expression of the genes, such as P53 and neuroblastoma gene product which encode proteins that bind and inactivate all growth regulatory proteins. Loss of P53 gene makes the cell more susceptible to mutation, thus releasing the mechanisms that inhibit the cell growth.

Human T-cell lymphotropic virus (HTLV-1) is the only oncogenic retrovirus, known to cause oncogenesis in humans. It encodes a protein (*tax*) that transactivates gene expression, including genes for interleukin-2 and other growth-stimulating lymphokines. The virus continues to produce virus in the transformed cells. Leukemia associated with HTLV-1 develops very slowly, 20–30 years after infection.

### ▶ Cytopathic effect

Cytopathic effect, or CPE, is a term that denotes any visible change in the appearance of target cells infected by viruses. Some viruses can be tentatively identified by the nature of CPE in cell culture, as well as by the types of cells in which these viruses cause CPE.

**Inclusion bodies:** Inclusion bodies are the characteristic histological feature in virus-infected cells reflecting the change in the appearance of the target cells. They may result from virus-induced changes in the membrane or chromosomal structure. They also represent the sites of viral replication or accumulation of viral capsids. Inclusion bodies are the structures with distinct size, shape, location, and staining properties that are found in virus-infected cells. The inclusion bodies may be found in the nucleus (e.g., herpes virus), cytoplasm (e.g., pox virus), or both (e.g., measles virus).

Intranuclear inclusion bodies are of two types: Cowdry type A and Cowdry type B. Cowdry type A inclusion bodies are of variable size, and are produced by infection with herpes virus and yellow fever virus. Cowdry type B inclusion bodies are often multiple and more circumscribed, and are produced by adenovirus and poliovirus infection. *Owl's eye* appearance are typical intranuclear inclusion bodies demonstrated in cytomegalovirus infection (Fig. 51-3).

These inclusion bodies may be acidophilic, which appear as pink structures when stained with Giemsa or eosin methylene blue stains. They may be basophilic as produced by some viruses, such as adenovirus (Table 51-3).

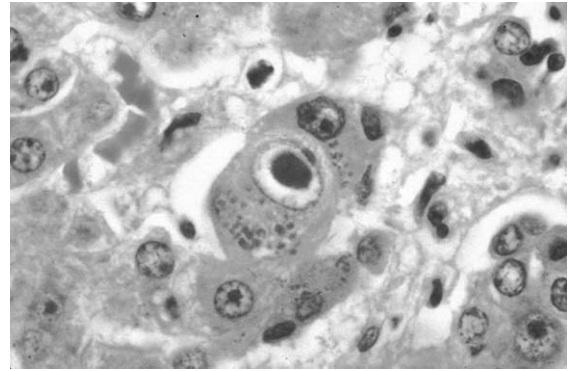

FIG. 51-3. Cytomegalovirus inclusion body ( $\times 1000$ ).

TABLE 51-3

### Inclusion bodies produced in viral infections

Inclusion body	Virus
<b>Intracytoplasmic inclusion bodies</b>	
Negri bodies	Rabies virus
Molluscum bodies	Molluscum contagiosum virus
Guarnieri bodies	Vaccinia virus
Bollinger bodies	Fowl pox virus
Perinuclear cytoplasmic acidophilic bodies	Reovirus
<b>Intranuclear inclusion bodies</b>	
Owl's eye inclusion bodies	Cytomegalovirus
Cowdry type A inclusion bodies	Herpes simplex virus and measles virus
Intranuclear basophilic	Adenovirus
Acidophilic inclusion bodies	Papovavirus

### Key Points

Demonstration of inclusion bodies is characteristic of a particular viral infection; presence of such bodies facilitates laboratory diagnosis:

- **Negri bodies** are the intracytoplasmic eosinophilic inclusion bodies in the neural cells and are pathognomic of *rabies*.
- **Guarnieri bodies** are small, multiple inclusions found in *vaccinia-infected cells*.
- **Bollinger bodies** are large inclusions seen in *fowl pox*.
- **Molluscum bodies** are very large inclusion bodies seen in the *molluscum contagiosum infected cell*.

### Persistent Viral Infection

The persistent viral infection is characterized by viral infection without cell death. The persistent viral infection is caused by slow and gradual release of viruses from the infected cell through exocytosis or through budding from plasma membrane. The persistent viral infections may be (a) nonlytic and productive (chronic), (b) latent, limited production of viral

macromolecules in the absence of synthesis of virus, (c) recurrent, or (d) transforming.

HSV typically causes a latent infection in neurons that lack the machinery to transcribe the immediate early viral genes essential for viral replication. But stress and other stimuli activate successful replication of virus, resulting in the infection.

Certain DNA viruses may cause infection of the cell, resulting in a latent or immortalizing infection. This occurs due to the failure of biosynthesis machinery of viruses for transcribing all the viral genes. The specific transcription factor needed of such a virus may be expressed in growing cells or in specific tissues, or after treatment with hormones or cytokines.

### Host Response to Viral Infections

The main goal of the host response in viral infection is (a) to eliminate the virus and (b) to eliminate the infected cells harboring or replicating the virus. The host responds by immunologic and nonspecific means. The immune response is the best and most important means of controlling virus infections.

### Immunity in Viral Infections

Protection against viral infections is induced by both humoral and cell-mediated immunities. Infection by the virus and subsequent replication induces immunity in the host against a wide range of virus antigens including the viral internal and surface antigens, nonstructural antigens, and early proteins (Table 51-4).

#### ▶ Humoral immunity

The humoral immunity mediated by antibody plays an important role against (a) infections caused by extracellular viruses and (b) viremias caused by those viruses. The humoral immunity also inhibits multiplication of cytolytic viruses. The circulating IgG and IgM antibodies are effective against viruses in blood and tissue spaces while IgA plays an important role

against viruses replicating on the mucosal surfaces. The antibodies act against viruses in many ways:

- They prevent adsorption of virus to the cell receptor at the primary site of infection.
- They also cause rapid degradation of viruses and also prevent release of the viral progeny from infected cells.
- The antibodies in combination with complement cause damage to the enveloped viruses resulting in cytolysis of virus infected cells.

The antibodies against surface antigens are usually more effective than against internal antigens. The antibodies produced against surface antigens also vary in their ability to reduce infectivity of viruses. For example, the antihemagglutinin antibodies produced against hemagglutinin antigen of influenza virus neutralizes infectivity of the influenza virus, while anti-neuraminidase antibodies against neuraminidase antigen are not effective in neutralizing the infectivity of the virus. The antineuraminidase antibody however is helpful in preventing the release of virion progeny from infected cells.

Humoral antibodies, although are protective, in some instances may cause injuries to host cells and contribute to pathogenesis of disease. For example, antibodies in combination with complement initiate an immune complex disease in infections caused by hepatitis B virus and rubella viruses. Interferons and lymphokines stimulate flu-like symptoms in respiratory virus infections and in viremia caused by arboviruses.

#### ▶ Cell-mediated immunity

Cell-mediated immunity (CMI) plays a very important role in viral infections:

- CMI is essential for lysis of target cells in the infections caused by enveloped viruses and also in noncytolytic infections caused by hepatitis A virus. Individuals with deficient cellular immunity are more susceptible to infection by viruses, such as herpes virus, measles virus, and poxvirus.
- CMI also plays a major role in recovery from viral infections. A deficient CMI results in failure to resolve the infection, which may lead to persistent viral infection, chronic disease, and even death of the patient.

**TABLE 51-4** Immunopathogenesis of viral infections

Viruses	Pathology	Immune mediators
Enveloped viruses	Delayed type hypersensitivity and inflammation	T cells, macrophages, and polymorphonuclear leukocytes
Respiratory viruses, arboviruses	Flu-like symptoms	Interferon, lymphokines
Dengue virus	Hemorrhagic disease	T cell, antibody, complement
Hepatitis B virus, rubella	Immune complex disease	Antibody, complement
Human immunodeficiency virus, cytomegalovirus, measles virus, influenza virus	Immunosuppression	T cells, antibody

■ CMI also contributes to pathogenesis of diseases by inducing T-cell-induced inflammatory and hypersensitivity reactions. For example, CMI-induced inflammatory response is responsible for the typical clinical manifestation of measles and mumps rather than cytopathologic effect of viruses. In dengue hemorrhagic fever, antigen-specific T cells and specific antibodies induce significant inflammatory and hypersensitivity damage to infected endothelial cells, leading to hemorrhage. Antigen-specific T cells are also responsible for inducing postinfection cytolysis in the infection caused by enveloped viruses, such as measles virus. T cells, macrophages, and polymorphonuclear leukocytes induce a delayed type hypersensitivity and inflammation in many viral infections caused by enveloped viruses.

Infection by some viruses is usually associated with suppressed host immunity; for example, infection by measles virus causes a temporary depression of delayed hypersensitivity to tuberculin antigen and infection by HIV causes a depressed CMI following depletion of CD4+ helper T cells.

Once infected by a virus, it usually confers a lifelong immunity to reinfection. In some viral infections, such as influenza or common cold, the immunity is not lifelong, because the infection is caused by antigenically different strains of the same virus.

### ► Nonimmunological responses

These include many factors as follows:

**Age:** Age is the most important factor in determining the susceptibility of the host to viral infections. Most viral infections are common and are more serious in the persons at extremes of age, such as infants, children, and elderly population. Infants and children are more susceptible to a variety of respiratory and exanthematous viral diseases. They are prone to more serious disease caused by paramyxovirus, respiratory infections, etc. Similarly, the elderly people are susceptible to new viral infections (the new strains of influenza A and B virus) and reactivation of the latent viruses (e.g., varicella zoster virus).

**Poor nutrition:** Poor nutrition or malnutrition affects the immune system of the infected person because tissue-regenerating capacity is usually decreased in a person with malnutrition. In such persons, some viral infection (such as measles) causes immunosuppression, thereby facilitating replication of viruses in large numbers. This results in a serious disease associated with more serious and fatal complications.

**Genetic make up:** Genetic make up of a person also plays an important role in determining the outcome of viral infection. Genetic differences in immune response genes and genetic defects in other genetic loci affect the susceptibility of the host to viral infection as well as the severity of infection.

**Body temperature:** Fever is a common manifestation of many viral infections. Fever acts as a natural defense mechanism against virus infections as many of the viruses are inhibited by a higher temperature above 39°C.

## Interferons

Interferons are a family of glycoproteins produced by cells on induction of infection by viral or nonviral microbial agents. These interferons show antiviral activity by inhibiting protein synthesis.

## Clinical Manifestations of Viral Diseases

The clinical manifestations of viral diseases depend on complex interaction of virus and host factors:

1. The age, general health, and immune status of the person.
2. The dose of the infective virus.
3. The genetics of the host and the virus.

After a host is infected by virus, the immune status of the host plays an important role and determines the outcome of viral infection—whether it will be an asymptomatic infection, a benign disease, or a life-threatening disease.

**Incubation period:** Incubation period is the time taken by the virus to spread from the site of entry to the organs of viral replication and then to the target organs for production of lesions. The duration of incubation period, therefore, depends on the (a) time taken for the site of entry, (b) multiplication, and (c) lesions. The incubation period for many viral diseases is variable:

1. It is short (1–3 days) in the infections caused by respiratory viruses or gastroenteritis caused by enteric virus, in which both the site of entry and lesions are the same.
2. Incubation period on the other hand is longer in systemic (usually 10–20 days) diseases in which viruses enter through the respiratory or alimentary tract and produce lesions in different target tissues away from the site of entry. But in some systemic viral diseases, such as yellow fever or dengue fever, it may be relatively shorter (5–6 days).
3. Incubation period may still be longer (2–6 months) in hepatitis B virus infection or even years in slow virus infection.

Incubation periods of common DNA and RNA viruses viral infections are summarized in Tables 51-5 and 51-6, respectively. In some viral infections, the incubation period may

TABLE 51-5

Incubation periods of common DNA viruses

Diseases	Incubation period (days)
Adenovirus	5–7
Herpes simplex	5–8
Small pox	12–14
Chicken pox	13–17
Infectious mononucleosis	30–50
Hepatitis B	50–150
Papilloma (warts)	50–150

TABLE 51-6

## Incubation periods of common RNA viruses

Diseases	Incubation period (days)
Common cold	1-3
Influenza	1-2
Dengue	5-8
Enteroviruses	6-12
Poliomyelitis	5-20
Measles	9-12
Mumps	16-20
Rubella	17-20
Hepatitis A	15-40
Rabies	30-100
Human immunodeficiency virus	1-10 years

proceed without symptoms, causing asymptomatic infections or may cause nonspecific early symptoms known as the *prodrome*. Incubation period is the important initial period before the manifestation of characteristic symptoms of the disease. During this period virus replicates in the body of the host but has not reached the target tissue or caused sufficient damage in tissues of the host to cause the disease.

The severity of the viral disease depends on the site of viral infection and on the immunopathological responses induced following the viral infection. It may be (a) an inapparent infection, (b) an acute infection, or (c) a chronic or persistent infection. Inapparent infection is usually caused if:

- (a) the infection is controlled before the virus reaches the target tissues,
- (b) the infected tissue is not damaged,
- (c) the tissue is damaged but it is rapidly repaired, or
- (d) the severity of damage is below a functional threshold for the particular disorder.

The inapparent infections are detected usually by serological tests detecting specific viral antibodies in the infected host. Epidemiologically, the patients with inapparent or asymptomatic infection serve as the major source of infection.

The onset of acute or chronic viral disease depends on the ability of the immune system of the infected host to control and resolve the viral infection. If the immune system acts rapidly, the infection may result in acute disease; or if the immune system fails to act effectively or slowly, it may result in chronic disease. Slow virus infections have typically long incubation period of many years before progressing to manifestation of the disease.

## Epidemiology

### Geographical Distribution

Geographical distribution of the viral infections depends on (a) the presence of vectors for the transmission of disease, (b) cofactors facilitating the transmission of disease, and

(c) the presence of susceptible population in the particular area. For example, the presence of suitable arthropod vectors for a particular virus in large numbers increases the risk of high prevalence of viral disease in that community.

Viral diseases also show seasonal differences; for example, enteric viruses are more prevalent in the summer due to poor hygiene and use of contaminated water because of shortage of water supply. Similarly, respiratory viruses are more prevalent during winter due to overcrowding, which facilitates the spread of the viruses. The viral infection in a community may occur as an (a) outbreak, (b) epidemic, or (c) as pandemic:

- The **outbreak** of a viral disease usually occurs from a common source, for example, infected food, and is seen only in clusters of people.
- **Epidemics** of viral infection, in contrast, occur in a large geographical area. An epidemic usually occurs due to introduction of a new strain of virus into an immunologically susceptible population, e.g., influenza epidemic.
- **Pandemics** are usually worldwide epidemics resulting from the introduction of a new virus, e.g., HIV. Pandemics of influenza have occurred as a result of introduction of new strains of influenza viruses.

## Reservoir and Sources of Infection

Infected humans are usual reservoirs of viruses. They serve as source of infection for other susceptible hosts (HIV, poliomyelitis, etc.). For many other viral diseases, animals also act as reservoirs. Viral infections transmitted from these animal reservoirs to humans are called zoonotic viral diseases; for example, rabies is a zoonotic viral disease, and the infection is transmitted from the infected dogs, bats, foxes, cats, etc., to humans.

Mosquitoes, ticks, and sand flies are the arthropods that act as vectors for transmission of togaviruses, flaviviruses, bunyaviruses, and reoviruses. These viruses, hence, are called as *arboviruses* (from *arthropod-borne viruses*).

Asymptomatic patients are the important source of infection. In HIV and varicella zoster virus infections, the viruses are usually released before the manifestations of the symptoms. Viruses changing the antigenic structure of their genome, e.g., influenza and HIV, infect a large number of immunologically naive population. Rhinovirus and other viruses with many different types similarly cause infection in a large number of susceptible persons.

## Transmission

The mode of transmission of virus depends on (i) the site of viral replication and secretions and (ii) presence or absence of envelope in the viruses:

1. **The site of viral replication and secretions:** The viruses that replicate in the intestinal tract are excreted in the feces and are transmitted by fecal-oral route (e.g., picornavirus and reovirus). The viruses that replicate in the respiratory tract, such as influenza virus, are secreted in aerosol droplets, hence are transmitted by inhalation.

**2. Presence or absence of envelope in the viruses:** The *enveloped viruses* are relatively fragile viruses, which require presence of intact envelope for their infectivity. These viruses are usually transmitted by respiratory droplets, saliva, mucus, blood or semen, organ transplantation, and by ingestion. Many of the enveloped viruses, since they are sensitive to the presence of acid and detergent, are destroyed rapidly in the gastrointestinal tract of the infected humans and hence are not transmitted by fecal-oral route. Hepatitis B virus and coronavirus are exceptions, which are transmitted by fecal-oral route.

*Nonenveloped viruses* are relatively sturdy viruses. These can resist drying, extremes of pH and temperature, and the effects of detergents. These nonenveloped viruses, therefore, withstand the acidity of the stomach and lytic effect of bile in the intestine as well as they withstand mild disinfectants and

insufficient sewage technique. Therefore, these viruses are generally transmitted by the respiratory and fecal-oral routes and also often by contaminated objects (fomites). Hepatitis A virus is a common example of enveloped virus transmitted by fecal-oral route. Rhinoviruses and many other nonenveloped viruses are the examples of viruses that are transmitted by contact with fomites, such as handkerchief, towels, bed linens, etc.

### Prevention of Viral Diseases

---

The viral diseases can be prevented and spread of viruses can be controlled by (a) adoption of good hygiene, (b) by control of the vectors, and (c) by immunization of the population. Immunization of the population by vaccines is the best means for the control of many diseases. Vaccines are available against many viral diseases (poliomyelitis, rabies). These protect the population against infection by viruses.



# Antiviral Agents

## Introduction

The viruses, unlike most bacteria, are obligate intracellular pathogens that use biosynthesis mechanisms and enzymes of the host cells for replication. Hence, it was feared that it may not be possible to inhibit viral replication without also being toxic to host cells, but currently newer antiviral drugs are used successfully for treatment of few viral diseases without causing much of toxicity or serious side effects.

The first antiviral drugs to be used were like selective poisons that targeted cells with intensive DNA and RNA synthesis. Recently used antiviral drugs, however, act specifically against virus-coded enzymes or structures of the virus that are important for replication of the viruses.

Marboran was the first antiviral drug used clinically for effective treatment of poxvirus infection in 1960. The compound was used successfully against eczema vaccinatum and smallpox. Subsequently in 1962, an antineoplastic agent idoxuridine was found to be effective for treatment of herpetic eye infection, and amantadine (a molecule with an unusual structure) was found effective for treatment of influenza A virus.

In 1970s, acyclovir (ACV) was used most successfully for treatment of herpes virus infection by administering the drug parenterally. Subsequently, many antiviral agents have been distributed for use against many viral infections including human immunodeficiency virus (HIV) (Box 52-1).

### Box 52-1

#### List of viral infections against which antiviral drugs are available

1. Herpes simplex virus
2. Varicella zoster virus
3. Cytomegalovirus
4. Human immunodeficiency virus
5. Influenza A virus
6. Respiratory syncytial virus
7. Hepatitis A, B, and C viruses
8. Papillomavirus
9. Picornavirus

## Mechanism of Action of Antiviral Drugs

Recently, many antiviral drugs have been developed against viruses that are associated with high morbidity and mortality in humans. These viruses provide potential targets during the cycle of replication for action by antiviral drugs. The viral infection may be inhibited at the level of (i) attachment, (ii) penetration and uncoating, (iii) transcription of viral nucleic acid, (iv) translation of viral mRNA, (v) protein synthesis, (vi) replication of viral DNA (vii) nucleoside biosynthesis and nucleoside scavenging, and (viii) assembly and release of viral progeny. Mechanisms of action of antiviral agents against the possible targets are summarized in Table 52-1.

## Classification of Antiviral Drugs

The antiviral compounds vary greatly in complexity and include nucleoside analogs, synthetic oligonucleotides, oligosaccharides, and also natural products of plants and some inorganic and organic compounds. The antiviral agents available against viruses can be classified as: (a) nucleoside analogs, (b) non-nucleoside polymerase inhibitors, (c) protease inhibitors, (d) neuraminidase inhibitors, (e) M2 channel blockers, and (f) interferons.

## Nucleoside Analogs

Numerous analogs of naturally occurring nucleosides have been synthesized in the laboratory for their possible use against viruses. These nucleoside analogs that act by inhibiting the enzyme viral polymerase are generally activated by phosphorylation by cellular or viral kinases.

## Key Points

**Nucleoside analogs** cause selective inhibition of viral replication:

- by binding better to viral DNA polymerase, rather than to the cellular DNA polymerase; and
- by being utilized more extensively in virus-infected cells due to the more rapid synthesis of DNA in infected cells.

TABLE 52-1

## Mechanisms of action of antiviral drugs

Virus	Antiviral drug	Mechanism of action
Herpes simplex virus	Acyclovir Vidarabine	Viral polymerase inhibitors (nucleoside analog)
Varicella zoster virus and herpes simplex virus	Valacyclovir	Viral polymerase inhibitor (nucleoside analog)
Cytomegalovirus	Ganciclovir Foscarnet	Viral polymerase inhibitors
Human immunodeficiency virus	Zidovudine	Nucleoside reverse transcriptase inhibitors
	Didanosine	
	Zalcitabine	
	Stavudine (d4T)	
	Lamivudine (3TC)	
	Nevirapine	Non-nucleoside reverse transcriptase inhibitors
	Delaviridine	
	Saquinavir	
	Ritonavir	Protease inhibitors
	Indinavir	
	Nelfinavir	
Enfuvirtide		
Raltegravir	Integrase inhibitor Fusion inhibitor	
Influenza A virus	Amantadine	Blocks viral uncoating
	Rimantidine	
	Oseltamivir	Neuraminidase inhibitor
Hepatitis C virus	Interferon alpha	Inhibits protein synthesis
Respiratory syncytial virus	Ribavirin	Blocks capping of viral mRNA

The commonly used nucleoside analogs are acyclovir, valacyclovir, penciclovir, and famciclovir, ganciclovir, azidothymidine (AZT), ribavirin, and dideoxynucleosides (dideoxyinosine, dideoxycytidine, stavudine, and lamivudine).

### ► Acyclovir

Acyclovir (ACV) is a synthetic guanine nucleoside analog. It differs from the nucleoside guanosine by having an acyclic (hydroxyethoxymethyl) chain instead of a ribose or deoxyribose sugar. The ACV has selective action against herpes viruses, such as herpes simplex virus (HSV) and varicella zoster virus. It acts through the viral enzyme thymidine kinase, encoded by these herpes viruses.

- The ACV is used for treatment of HSV infections, such as HSV encephalitis, disseminated herpes, and other serious life-threatening manifestations of herpes infections. The compound inhibits HSV replication in infected host cells but is ineffective to resolve the latent HSV infection.
- The ACV at higher doses is also effective against varicella zoster virus (VZV) infections. The compound is less effective against this virus because ACV is phosphorylated less efficiently by the VZV thymidine kinase.

### ► Valacyclovir

Valacyclovir is the valyl ester derivative of ACV that is well absorbed. Its bioavailability is 2–5 times more than ACV and

is usually recommended for the treatment and suppression of genital herpes infection.

### ► Penciclovir

Penciclovir is a guanosine analog. It has a higher affinity for HSV thymidine kinase than ACV but has a lower affinity for HSV DNA polymerase than ACV. It acts by inhibiting viral DNA polymerase and also as a chain terminator. It is used for the treatment of genital herpes infection.

- Penciclovir is effective for treatment of both HSV and VZV. After administration, the drug is available in more quantity and persists for a longer time in infected cells than ACV.
- The penciclovir also has some antiviral activity against cytomegalovirus and Epstein–Barr virus.

### ► Ganciclovir

Ganciclovir is a guanine nucleoside, chemically related to ACV. It differs from ACV in having a single hydroxymethyl group in the acyclic side chain. It acts as a chain terminator in subsequent termination of viral DNA replication. It is highly effective against all herpes viruses including cytomegalovirus. It is more active against cytomegalovirus (CMV) than ACV. It is more useful in treating severe CMV infections in immunocompromised hosts, such as acquired immunodeficiency syndrome (AIDS). Ganciclovir resistance is a noted problem of therapy with ganciclovir.

### ► Azidothymidine

Azidothymidine (AZT) is the synthetic analog of thymidine and was the first useful antiviral agent to be reported for treatment of HIV infection. It acts by blocking the synthesis of proviral DNA by inhibiting viral reverse transcriptase. The latter is 100 times more susceptible to inhibition by AZT than host cellular DNA polymerase.

- Azidothymidine is widely used for treatment of HIV infection. It is currently used for the management of HIV with reduced CD4 T-cell counts (400–500 or less) to prevent progression of the disease.
- It is also used for treatment of pregnant HIV-infected women. It has been shown to reduce or prevent the transmission of HIV from the mother to the baby.

The drug, however, is toxic and costly. Emergence of resistance to AZT is also a worrisome problem.

### ► Ribavirin

Ribavirin is a synthetic analog of the nucleoside guanosine. Ribavirin triphosphate is the active form of the drug. It differs from guanosine by having a base ring, which is incomplete and is open. Ribavirin is effective against many DNA and RNA viruses. It acts mainly by preventing replication of the viruses by inhibiting nucleoside biosynthesis, mRNA capping, and other processes essential for viral replication.

- When administered as an aerosol, ribavirin has been shown to be effective for treatment of severe respiratory syncytial viral infection in children and for treatment of severe influenza and measles in adults.
- Intravenous ribavirin is also effective for treatment of infections caused by influenza B virus and Rift Valley virus, and Lassa, Crimean-Congo, and other hemorrhagic fevers.
- Ribavirin in combination with interferon-alpha (IFN- $\alpha$ ) is shown to be effective against the infection caused by hepatitis C virus.

### ► Dideoxynucleosides

Dideoxynucleosides (e.g., dideoxyinosine, dideoxycytidine, stavudine, and lamivudine), the analogs of nucleosides, have been synthesized for use against HIV. These agents act by inhibiting HIV replication by blocking the enzyme reverse transcriptase. These compounds inhibit the enzyme reverse transcriptase by preventing DNA chain elongation. These compounds are usually recommended for the treatment of AIDS in patients not responding to therapy with AZT. These are also used in combination with AZT for treatment of the AIDS cases.

### ► Other Nucleoside Analogs

These consist of a number of compounds including idoxuridine, trifluorothymidine, fluorouracil, and adenine arabinoside.

These are analogs of thymidine. They inhibit synthesis and replication of viruses:

- by inhibiting the synthesis of thymidine, a nucleic acid essential for synthesis of viral DNA or
- by replacing thymidine with itself in the viral DNA.

These are effective against viruses such as herpes simplex virus (HSV), replication of which is associated with synthesis of large volume of viral DNA.

### *Idoxuridine*

Idoxuridine was the first antiviral drug to be used for treatment of HSV but now has been replaced by trifluorothymidine and fluorouracil. These two compounds are more effective and less toxic for treatment of HSV. Fluorouracil is also used for topical treatment of warts caused by human papilloma viruses.

### *Adenine arabinoside*

Adenine arabinoside is a purine nucleoside analog similar to adenosine. It differs from adenosine in having arabinose instead of ribose as the sugar moiety. It was used as an important antiviral agent for treatment of herpes virus infection until ACV become available. Recently, many other nucleoside analogs have been evaluated as antiviral agents for treatment of infections caused by HIV, hepatitis B virus, and herpes viruses.

## Non-Nucleoside Polymerase Inhibitors

Non-nucleoside polymerase inhibitors include foscarnet and related phosphonoacetic acid. These inhibitors inhibit replication of viruses by binding to the pyrophosphate binding site of the DNA polymerase to block binding of nucleotides. Foscarnet specifically inhibits DNA polymerase of all herpes viruses and reverse transcriptase of the HIV. The compound has also shown antiviral activity against hepatitis B virus.

Nevirapine, delavirdine, and efavirenz are the other non-nucleoside polymerase inhibitors with different mechanisms of action. They bind to sites on the enzyme different from the substrate. These compounds are usually given in combination with other nucleoside analogs to delay or prevent emergence of drug resistance in HIV.

## Protease Inhibitors

Saquinavir, indinavir, ritonavir, nelfinavir, and amprenavir are some of the examples of protease inhibitors. These agents act specifically on the unique structure of HIV protease, which is essential for the production of a functional HIV. Human immunodeficiency virus strains showing resistance to these drugs occur through mutation of the HIV protease. Hence, a combination of protease inhibitor with AZT and a nucleoside analog is usually recommended to reduce replication of viruses to minimum undetectable levels.

## Other Antiviral Drugs

Amantadine (Adamantanamine hydrochloride, symmetrel) and rimantadine are anti-influenza drugs useful for treatment of influenza virus infections. These are not effective for treatment of influenza B or C viruses. These act specifically against influenza A virus by their ability to bind and to block protein channel by the matrix protein (M2) of the influenza A virus. Resistance to these drugs occurs due to mutations, resulting in changed M2 matrix protein or hemagglutinin protein.

Amantadine and rimantadine are useful in reducing severity of influenza A infection if taken within 48 hours of exposure. They are also useful as prophylactic agents in treatment of influenza A infection. Amantadine is also used for treatment of Parkinson's disease. The drug, however, is toxic to the central nervous system.

Zanamivir (Relenza) and oseltamivir (Tamiflu) are the antiviral compounds with clinical efficacy against both the influenza A and B viruses. They are potent inhibitors of the influenza neuraminidase. Without production of the enzyme neuraminidase, the hemagglutinin of the virus binds to sialic acid on other viral particles, forming clumps and thereby preventing release of virus particles. In several clinical trials, both the agents have demonstrated efficacy with minimal side effects. If taken within 48 hours of infection, these drugs reduce the duration of illness.

## Interferon

There are three classes of interferon: (*i*) interferon alpha (IFN- $\alpha$ ), (*ii*) interferon beta (IFN- $\beta$ ), and (*iii*) interferon gamma

(IFN- $\gamma$ ). IFN- $\alpha$  occurs as at least 15 subtypes, the genes for which show 85% homology. Interferons are produced by leukocytes and many other cells in response to infection by virus, double-stranded RNA (dsRNA), endotoxin, and mutagenic and antigenic stimuli. The dsRNA is a potent stimulator. The viruses that replicate slowly and viruses that do not inhibit synthesis of host proteins are usually good inducers of the interferons. IFN- $\gamma$  differs from other interferons in being released as lymphokines from activated T cells, natural killer cells, and occasionally from macrophages. Interferons exert antiviral effect by several pathways as follows:

1. They cause increased expression of class I and class II MHC (major histocompatibility complex) glycoproteins, thereby facilitating the recognition of viral antigens by immune system.
2. They activate the cells, such as natural killer cells and macrophages, the cells with the ability to destroy virus-infected targets.
3. They directly inhibit replication of viruses.

Interferons are now being increasingly used for treatment of chronic hepatitis B and C virus carriers who are at risk to progress to cirrhosis and hepatocellular carcinoma. The interferon when given with ribavirin has proved to be more effective than interferon alone for treatment of hepatitis C virus infection. Currently, synthetic IFN- $\alpha$  is actively used against hepatitis A, B, and C viruses; papilloma virus; HSV; and rhinovirus. It is also used for the treatment of condylomata acuminatum.

# Laboratory Diagnosis of Viral Diseases

## Introduction

The clinical manifestations may be protean and nonspecific for many of the viral infections. However, they provide a clue in the diagnosis of viral infections by exclusion of common bacterial, parasitic, fungal diseases, etc. Laboratory diagnosis, therefore, plays an important role in confirming viral etiology of suspected viral diseases. Laboratory diagnosis for viral diseases is performed to:

1. Confirm the viral etiology of diseases for which antiviral chemotherapeutic agents are available.
2. Screen blood donors for blood-borne viral pathogens, such as hepatitis B and C, human immunodeficiency virus (HIV), etc., to prevent transmission of infection by transfusion of blood and blood-borne products contaminated by viruses.
3. Define the viral disease process.
4. Perform seroepidemiological studies of viral infections.
5. Monitor and detect epidemics of serious virus infections, such as influenza, encephalitis, and poliomyelitis, etc., earlier so as to initiate appropriate control measures to prevent further spread of these diseases.

## Methods of Laboratory Diagnosis

Laboratory diagnosis of viral infections can be carried out by many methods. These methods include (a) demonstration of virus-induced cytopathic effects (CPEs) in the cells, (b) direct detection of viruses, (c) virus isolation and viral assays, (d) detection of viral proteins and other enzymes, (e) detection of viral genome, and (f) viral serology (Fig. 53-1).

### Demonstration of Virus-Induced CPEs in the Cells

Many viruses produce characteristic morphological changes in the cells they infect. These changes are known as CPEs, and the viruses causing the CPEs are known as cytopathogenic viruses. The characteristic CPEs include (a) change in cell morphology, such as rounding of cells or rounding and aggregation of cells, (b) syncytia formation, and (c) inclusion bodies formation.

- Replication of virus in infected cells may cause rounding, refractility, degeneration, and nuclear pyknosis. This

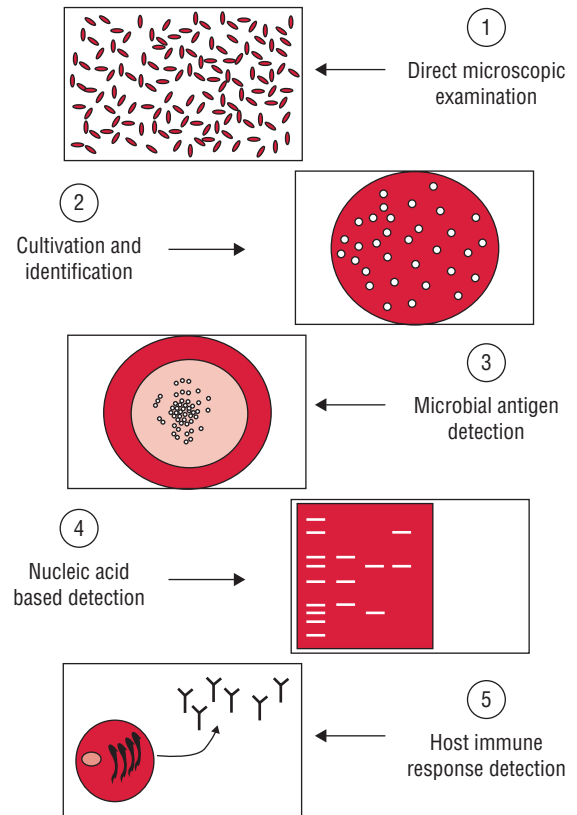

FIG. 53-1. Approaches for laboratory diagnosis of viral infections.

may finally lead to complete or partial cell lysis as well as vacuolation, as seen in picornaviruses. Viruses, such as adenoviruses, may cause rounding of cells and aggregate to form grape-like clusters.

- Viruses, such as paramyxovirus, varicella zoster, respiratory syncytial virus, and herpes simplex virus (HSV), cause formation of syncytia containing several (up to 100) nuclei in infected cells. These syncytia are multinucleated giant cells formed by fusion of virus-infected cells with neighboring or uninfected cells.
- Inclusion bodies are intranuclear or cytoplasmic bodies produced by viruses in infected cells. They are produced as a result of histological changes in infected cells caused by viral components. These are also produced as a result of virus-induced changes in cell structures.

These inclusion bodies can be demonstrated on staining by light microscopy. These inclusion bodies may be acidophilic

TABLE 53-1

Laboratory procedures for diagnosis of viral infections

Approaches	Methods
Demonstration of virus-induced cytopathic effects (CPEs) in the cells	Characteristic CPEs include (a) change in cell morphology, such as rounding of cells, or rounding and aggregation of cells, (b) syncytia formation, and (c) inclusion bodies formation
Direct detection of viruses	Electron microscopy, fluorescence microscopy, and light microscopy
Virus isolation	Animal inoculation, embryonated egg inoculation, and cell culture
Detection of viral proteins and other enzymes	The enzyme-linked immunosorbent assay (ELISA), direct immunofluorescence assay, RIA, etc.
Detection of viral genome	DNA probes, dot blot or Southern blot analysis, Northern blot or RNA:DNA probe hybridization, polymerase chain reaction (PCR), and reverse transcriptase PCR (RT PCR)
Viral serology	Hemagglutination inhibition (HI) test, neutralization test (NT), indirect fluorescent antibody (IFA) test, ELISA, RIA, latex agglutination test (LAT), and Western blot

or basophilic, small or large, round or irregular; and single or multiple. These bodies may be present either in nucleus or cytoplasm, or in both. Many viruses produce different types of inclusion bodies. For example, rabies virus produces intracytoplasmic inclusion bodies called Negri bodies in neural tissue of the brain. Cytomegalovirus (CMV) produces intranuclear owl's eye inclusion bodies (Color Photo 53) in infected cells or in cell sediments excreted in the urine of the patient infected with CMV. Human herpes viruses produces Cowdry type A inclusion bodies. Measles virus produces inclusion bodies that are seen both in the cytoplasm and nucleus of infected cells (Table 53-1).

## Direct Detection of Viruses

Viruses can be detected directly in clinical specimens by electron microscopy (EM), fluorescence microscopy, and light microscopy.

### ▶ Electron microscopy

Electron microscopy is the most commonly used method for direct detection of virus in clinical specimens for diagnosis of many viral diseases. EM can be used to detect distinctive viruses or viral structures directly in appropriate clinical specimens or in biopsy for diagnosis of viral infections. EM is not a routinely used test for detection of viral infection and is performed only in the laboratories equipped with electron microscope.

### Key Points

Electron microscopy is used for detection of:

- rotaviruses and herpes virus in stool samples,
- herpes virus in brain biopsy specimens, and
- poxvirus in vesicle fluid.
- virus in cell cultures.

### ▶ Fluorescence microscopy

Direct fluorescence microscopy (DFA), using specific monoclonal or polyclonal antibody, is employed to detect viral antigens

on the cell surface or within the cells infected by viruses. The viral antigens can be detected (a) in the acetone-fixed cell smears, (b) in the frozen tissue sections of the cells from virus-infected cells, and (c) also in vesicular fluid. The DFA test has been employed for:

- antemortem diagnosis of rabies by detection of rabies-virus antigen in smears from the face or nape of the neck;
- demonstration of viral antigens in brain biopsy specimens for diagnosis of herpes simplex encephalitis and subacute sclerosing encephalitis; and
- rapid diagnosis of infections caused by adenoviruses, paramyxoviruses, and orthomyxoviruses.

### ▶ Light microscopy

Viral antigens in infected cell cultures are demonstrated by immunoperoxidase staining.

## Virus Isolation

Demonstration of virus in appropriate clinical specimens by culture establishes diagnosis of viral diseases. Isolation of virus is always considered as a gold standard for establishing viral etiology of a disease. Collection of appropriate clinical specimens depends on type of the viral disease. For example, cerebrospinal fluid (CSF) is the specimen of choice for diagnosis of viral infections of the central nervous system (CNS) caused by arboviruses, picornavirus, or rabies virus. Blood is the specimen frequently examined for diagnosis of HIV and hepatitis B, C, and D infections and other blood-borne viral infections. The tests of other clinical specimens to be collected for diagnosis of other types of viral diseases are summarized in Table 53-2.

Timing of collection of specimen is important. The specimens collected early in the acute stage infection—before the shedding of virus is stopped—are most important. For example, enteroviruses are present in the CSF for only 2–3 days after the onset of CNS manifestations. Herpes simplex virus and varicella zoster virus are found in lesions only within first 5 days of onset of symptoms and respiratory viruses are present in respiratory secretions during only first 3–7 days of onset of symptoms.

TABLE 53-2

Laboratory specimens for diagnosis of viral infections

System	Direct examination	Isolation	Serology
Respiratory system	Nasopharyngeal aspirate (IF, EM)	Throat swab, throat washings	Paired sera
CNS	Brain biopsy (IF, EM), CSF (EM, IF)	Feces, blood (for arbovirus), CSF, and brain biopsy	Paired sera
Skin	Vesicular/pustular fluid (EM, ID), ulcer scrapings (EM), and crusts (EM, ID)	Macular/papular scrapings, vesicular/pustular fluid, ulcer scrapings, crust, urine	Paired sera
Eye	Conjunctival scrapings and smears (LM, IF)	Conjunctival scrapings or swabs	Paired sera
Liver	Serum and feces	Blood (for yellow fever)	Serum
Congenital infections	Nil	Throat swab, products of conception	Single sera (mother and baby)
Gastro-intestinal tract	Stool (antigen detection, EM for rotavirus)	Not cultured	Paired sera (ELISA)

IF, immunofluorescence; EM, electron microscope; ID, immunodiffusion; LM, light microscopy.

Immediate transport of the specimen to laboratory for processing also facilitates better isolation of virus from clinical specimens. The viruses are usually heat labile, and the clinical specimens may be infected secondarily by contamination with bacteria and fungi. Hence, clinical specimens for viruses are usually transported and stored on ice. They are transported in special transport media that contain antibiotics to inhibit bacterial and fungal contaminants and also contain proteins, such as serum albumin or gelatin. Some of the viruses, such as influenza virus, HSV, and VZV lose their infectious titer when clinical specimens are stored at room temperature or kept frozen at  $-20^{\circ}\text{C}$ . Most of the viruses can be cultivated in (a) experimental animals, (b) embryonated eggs, or (c) tissue culture.

### ► Animal inoculation

Mouse is most frequently used for isolation of viruses by animal inoculation. In addition, rabbits, hamsters, newborn or suckling rodents are also used. Experimental animals are rarely used for cultivation of viruses but play an essential role in study of pathogenesis of viral infections and that of viral oncogenesis.

Intracerebral, subcutaneous, intraperitoneal, or intranasal routes are various routes of inoculation. After inoculation, the animals are observed for signs of disease or death. The infected animals are then sacrificed and infected tissues are examined for the presence of viruses by various tests, and also for inclusion bodies in infected tissues. Furthermore, infant (suckling) mice are used for isolation of coxsackie virus and rabies virus.

### ► Embryonated eggs

Embryonated eggs were used initially for the growth of viruses. Embryonated chick egg was used first for cultivation of viruses by Goodpasture in 1931. The method further developed by Burnet was used for cultivation of viruses in different sites of the embryonated egg. Usually, 8–11 days' old chick eggs are used for culture of viruses. The viruses are isolated in different sites of the egg, such as yolk sac, amniotic cavity, and allantoic cavity, and chorioallantoic membrane (CAM) (Fig. 53-2).

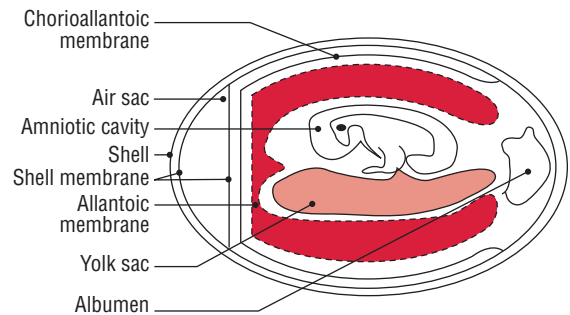

FIG. 53-2. Embryonated egg inoculation.

Many of these viruses cause well-defined and characteristic foci, providing a method for identification, quantification, or assessing virus pathogenicity. The embryonated egg is also used for growing higher titre stocks of some viruses in research laboratories and for vaccine production.

**Yolk sac:** Yolk sac inoculation is used for cultivation of Japanese encephalitis, Saint Louis encephalitis, and West Nile virus. It is also used for growth of chlamydia and rickettsia.

**Amniotic cavity:** Inoculation in the amniotic cavity is used mainly for primary isolation of influenza virus.

**Allantoic cavity:** Inoculation in the allantoic cavity is used for serial passages and for obtaining large quantities of virus, such as influenza virus, yellow fever (17D strain), and rabies (Flury strain) viruses for preparation of vaccines. For production of rabies virus, duck eggs were used due to their bigger size than that of hen's egg. This helped in production of large quantities of rabies virus, which are used for preparation of the inactivated non-neural rabies vaccine.

**Chorioallantoic membrane:** Inoculation of some viruses on CAM produced visible lesions known as *pocks*. Each infectious virus particle produces one pock. The pox viruses, such as variola or vaccinia are identified by demonstration of typical pocks on the CAM inoculated with the pox virus. Nowadays, in a virology laboratory, chick embryo inoculation has been replaced by cell cultures for routine isolation of viruses.

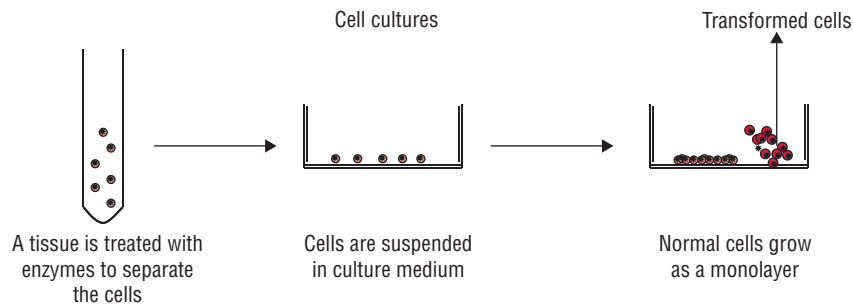

FIG. 53-3. Schematic diagram showing the steps in preparation of cell lines for culture.

## ► Tissue culture

Cell culture is most widely used in diagnostic virology for cultivation and assays of viruses. The tissue culture was first applied in diagnostic virology by Steinhardt and colleagues in 1913. They maintained the vaccinia virus by culture in tissues of rabbit cornea. Subsequently, Maitland (1928) used cut tissues in nutrient media for cultivation of vaccine viruses. Enders, Weller, and Robins (1949) were the first to culture poliovirus in tissue cultures of nonneural origin. Since then, most of the virus had been grown in tissue culture for diagnosis of viral diseases. Different types of tissue cultures are used to grow viruses. Tissue culture can be of three different types as follows:

### Organ culture

This was used earlier for the isolation of some viruses, which appear to show affinity for certain tissue organs. For example, coronavirus, a respiratory pathogen, was isolated in the tracheal ring organ culture. In this method, small bits of the organs are maintained *in vitro* for days and weeks preserving their original morphology and function. Nowadays, organ culture is not used.

### Explant culture

In this method, components of minced tissue are grown as explants embedded in plasma clots. Earlier, adenoid tissue explant cultures were used for isolation of adenoviruses. This method is now seldom used in virology.

### Cell culture

Cell culture is now routinely used for growing viruses. In this method, tissues are dissociated into component cells by treatment with proteolytic enzymes (trypsin or collagenase) followed by mechanical shaking. The cells are then washed, counted, and suspended in a growth medium containing essential amino acids and vitamins, salts, glucose, and a buffering system. This medium is supplemented by up to 5% of fetal calf serum and antibiotics. The cell suspension is dispensed in glass or plastic bottles, tables, or Petri dishes. On incubation, the cells adhere to the glass surfaces and divide to form a confluent monolayer sheet of cells covering the surface within a week (Fig. 53-3). The cell culture may be incubated either as a stationary culture or as a roller drum culture. The latter is useful for growth of some fastidious viruses due to better aeration by rolling of the

TABLE 53-3

Cell lines in common use

Cell lines	Examples
Primary cell culture	Rhesus monkey kidney cell culture Human amnion cell culture Chick embryo fibroblast cell culture
Diploid cell strains	Human embryonic lung cell strain (WI-38) Rhesus embryo cell strain (HL-8)
Continuous cell lines	Human carcinoma of cervix cell line (HeLa) Human epithelioma of larynx cell line (Hep-2) Human carcinoma of nasopharynx cell line (KB) Human synovial carcinoma cell line (McCoy) Sternal marrow cell line (Detroit-6) Human conjunctiva (C), intestine (I), liver (L), and kidney (K) cell line (Chang C/I/L/K) Vervet monkey cell line Baby hamster kidney cell line (Vero)

culture bottle in special roller drums. The cell cultures are classified into three different types based on their origin, chromosomal characters, and number of generations for which they can be maintained, as follows (Table 53-3):

**Primary cell culture:** These are a culture of normal cells obtained freshly from the original tissues that have been cultivated *in vitro* for the first time and that have not been subcultured. These cell cultures can be established from whole animal embryo or from selected tissues from adult, newborn, or embryos. These cells have the normal diploid chromosomal number and are capable of only limited growth (5–10 divisions) in culture. They cannot be maintained in serial culture, but can be subcultured to obtain large number of cells. Monkey kidney cell culture (Fig. 53-4, Color Photo 54), human embryonic kidney cell culture, and chick embryo cell culture are the common examples of primary cell culture. Primary monkey kidney cell cultures are highly useful for the primary isolation of myxovirus, paramyxovirus, many enteroviruses, and some adenoviruses.

**Diploid cell strains:** Diploid cell strains are of a single cell type that retains their original diploid chromosome number and karyotype. However, they have specific characteristics and compositions and are usually composed of one basic





FIG. 53-4. Normal monkey kidney cell lines ( $\times 1000$ ).

cell type. They are usually fibroblasts and can be cultured for maximum 50 serial passages before they undergo senescence (die off) or undergo a significant change in their characteristics. Diploid cells derived from human fibroblasts are useful for isolation of some fastidious viruses. They are also used for production of vaccines; for example, WI-38 human embryonic lung cell stem is used for the cultivation of fixed rabies virus, and human fetal diploid cells for isolation of adenovirus, picornaviruses, HSV, CMV, and VZV.

**Continuous cell lines:** Continuous or immortal cell lines are cells of a single type, which are derived from cancerous tissue and are capable of continuous serial cultivation indefinitely without senescing. The cells are usually derived from diploid cell lines or from malignant tissues and have altered and irregular number of chromosomes. Immortalization may occur spontaneously or can be induced by chemical mutagens, tumorigenic viruses, or oncogens. Hep-2, HeLa, and KB derived from human carcinoma cervix, human epithelioma of larynx, and human carcinoma of nasopharynx and other cell lines are excellent for recovery of a large number of viruses. These cell lines have been used extensively for the growth of a number of viruses. These cell lines are usually stored at  $-70^{\circ}\text{C}$  for use when necessary or are maintained by serial subculture. The type of cell line used for virus culture depends on the sensitivity of the cells to a particular virus; for example, Hep-2 cell line is excellent for the recovery of respiratory syncytial viruses, adenoviruses, and HSV. Most of the viruses can be isolated by using one of these cell lines. Growth of viruses in cell cultures can be detected by the following methods:

- **Cytopathic effect:** Many viruses can be detected and initially identified by observation of the morphological changes in the cultured cells in which they replicate. The CPE produced by different types of viruses are characteristic and help in the initial identification of virus isolates. Nuclear shrinking, vacuoles in the cytoplasm, syncytia formation, rounding up, and detachment are the examples of

alteration of morphology of the cells. Most CPEs can be demonstrated in unfixed and unstained monolayer of cells under low power of microscope. For example, adenoviruses produce large granular changes resembling bunches of grapes, SV-14 produces well-defined cytoplasmic vacuolation, measles virus produces syncytium formation, herpes virus produces discrete focal degeneration, and enteroviruses cause crenation of cells and degeneration of the entire cell sheet.

- **Hemadsorption:** Hemadsorption is the process of adsorption of erythrocytes to the surfaces of infected cells which serves as an indirect measurement of viral protein synthesis. This property is made use of to detect infection with noncytotoxic viruses as well as the early stage of cytotoxic viruses. Viruses, such as influenza virus, parainfluenza virus, mumps virus, and togavirus, when infect cell lines code for the expression of red cell agglutinins, which are expressed on the infected cell membrane during infections. These hemagglutinins bind some erythrocytes to the infected cell surface. Sometimes, viruses can be detected by agglutination of erythrocytes in the culture medium.
- **Heterologous interference:** This property is used to detect viruses that do not produce classic CPEs in the cell lines. In this method, the growth of non-CPE-producing virus in cell culture can be tested by subsequent challenge with a virus known to produce CPEs. The growth of the first virus will inhibit infection by the cytopathic challenge virus by interference. For example, rubella virus usually does not produce any CPE, but prevents the replication of picornaviruses, which is inoculated as a cytopathic challenge virus.
- **Transformation:** Oncogenic viruses that are associated with formation of tumors induce cell transformation and loss of contact inhibition in the infected cell lines. This leads to surface growth that appears in a piled-up fashion producing microtumors. Examples of such oncogenic viruses that produce transformation in cell lines are some herpes viruses, adenoviruses, hepadanoviruses, papovavirus, and retroviruses.
- **Light microscopy:** Viral antigens in infected cell cultures are demonstrated by staining virus-infected cells of tissue sections with specific viral antibody conjugated with horseradish peroxidase. This is followed by addition of hydrogen peroxide along with a benzidine derivative substance. In a positive reaction, a red insoluble precipitate is deposited on the cell line, which is demonstrated by examination under ordinary light microscope.
- **Immunofluorescence:** Direct immunofluorescence using specific antibodies is frequently used to detect viral antigens in inoculated cell lines for identification of viruses.
- **Electron microscopy:** The viruses can also be demonstrated in infected cell lines by EM.

## Viral Assays

The virus content of a specimen can be assessed either by estimating total virus particles count or by assay of infectivity of viruses.

### ► Total virus particles count

Electron microscopy and hemagglutination are the two methods used for estimation of total virus particles.

**Electron microscopy:** EM is useful to count virus particles directly in a negatively stained viral suspension. In this method, the virus suspension is mixed with a known concentration of latex particles, and the number of virus particles in the suspension is estimated by a ratio between the virus and latex particles demonstrated by EM.

**Hemagglutination:** Quantitation of hemagglutinating viruses is carried out by determination of hemagglutination titers. Although it is not a sensitive method, it is used as a convenient method of virus assay. For example, approximately,  $10^7$  influenza virions are essential to produce microscopic agglutination in cultured cells.

### ► Assay of infectivity of viruses

Quantitative and quantal assays are the two types of assays, which are carried out to determine assay of infectivity of viruses.

**Quantitative assay of infectivity:** Quantitative assay is used to estimate the presence of actual number of viable infectious viral particles in the inoculum. Two methods are available for the purpose, which include plaque assay in monolayer cell culture and pock assay on chick embryo CAM.

- (a) **Plaque assay:** It was introduced by Dulbecco in 1952 as a modification of bacteriophage plaque assay. This is based on the principle that each infectious viral particle gives rise to a localized focus of infected cells that can be visualized by the naked eye. Such foci are called *plaques*, and each plaque indicates an infectious virus. The test is performed by adding a viral inoculum to a monolayer of culture cells in a bottle or Petri dish. After sometime, this allows adsorption of viruses. The liquid medium is removed and replaced with a solid agar gel to ensure that the spread of progeny virus is confined to the immediate vicinity of infected cells.
- (b) **Pock assay:** Viruses that form pocks on CAM can be assayed by counting the number of pocks formed on the inoculated CAM. Each pock on CAM arises from a single virus particle. This is known as pock assay. Vaccinia and variola viruses can be assayed by pock assay.

**Quantal assays of infectivity:** Quantal assays of infectivity can be carried out to quantitate a virus by quantitating the virus particles in animals, in embryonated eggs, or in tissue culture. This method of assay of infectivity only indicates the presence or absence of infectious viruses, but it does not indicate actual number of viruses. The endpoints used for infectivity titrations are estimated by the (a) development of CPE in cell cultures, (b) production of hemagglutination in allantoic fluid of embryonated egg, or (c) death of experimentally infected animals. The titer of virus is usually expressed as the “50% infectious dose ( $ID_{50}$ )” per mL, which indicates the highest dilution of the inoculum that initiates detectable symptoms, antibodies, or other responses in 50% of inoculated test animals, eggs, or cell cultures.

## Detection of Viral Proteins and Other Enzymes

During replication of viruses in host cells, viral proteins, antigens, and other enzymes are produced. These viral products and components can be detected by many methods including biochemical, immunological, and molecular methods in clinical specimens.

Enzyme-linked immunosorbent assay (ELISA), direct immunofluorescence assay, and radioimmunoassay (RIA) are widely used methods. These methods are used for detection and identification of viruses and viral antigens in clinical specimens, as well as in cell cultures. These tests use specific monoclonal or monospecific antibodies that are raised against specific viral antigens.

Identification and quantification of specific virus can also be carried out by detection and assay of characteristic viral enzymes. For example, detection of reverse transcriptase in serum or cell culture suggests the presence of a retrovirus. Similarly, demonstration of hemagglutinins or hemadsorption in the cell culture indicates the presence of influenza virus.

## Detection of Viral Genome

The unique genomic structure and genetic sequences are the most important characteristics of the type and family of virus. Therefore, recently molecular methods are increasingly used for diagnosis of viral diseases. The restriction endonuclease fragment lengths from the genome of DNA viruses, such as HSV-1 and HSV-2 or the electrophoretic pattern of RNA viruses, such as influenza and reo viruses are considered as genetic fingerprints for these viruses.

The methods for detection of viral genome include (a) DNA probes, (b) dot blot or Southern blot analysis, (c) Northern blot or RNA:DNA probe hybridization, (d) polymerase chain reaction (PCR), and (e) reverse transcriptase PCR (RT PCR).



### Molecular Diagnosis

#### DNA probe

The DNA probes are highly sensitive and specific tools used for detection of virus in clinical specimens even in the absence of replication of virus. In this method, two strands of the target DNA in clinical specimens are first separated and then allowed to hybridize with a labeled single-stranded DNA probe. Enzyme-labeled or fluorescent-labeled DNA probes with sequences complementary to unique nucleic acid sequences of a viral genome can be used for detecting a virus. The hybridized labeled probe, after hybridization, can be detected by enzymatic or fluorescence method depending on the label used.

The commercially available DNA probes are available for detection of CMV, papillomavirus, and Epstein-Barr virus in clinical specimens. In situ hybridization is also used for the detection of integrated or nonintegrated copies of viral genomes in fixed permeability biopsy specimens in persistent infections or viral malignant conditions.

DNA probe is especially useful for:

- studying the expression of specific viral genomes on the different cell types;



- detecting, in clinical specimens, viral genomes that do not provide any CPE or for which no serological test are available; and
- detecting slowly replicating or nonproductive viruses, such as human papilloma virus or CMV.

### Southern blot analysis

Southern blot analysis or dot blot is used to detect viral genomes in clinical specimens. In this method, the viral genome or restriction endonuclease cleavage fragments of the genome are blotted onto nitrocellulose papers and then detected on the paper by their hybridization to DNA probes.

### Northern blot analysis

Northern blot analysis or RNA:DNA probe hybridization is a method also followed for detection of viral genomes. In this method, electrophoretically separated viral RNA are transformed onto a nitrocellulose paper and then detected by their hybridization to DNA probes.

### Polymerase chain reaction

It is a DNA amplification system that allows a millionfold amplification of a target sequence of nucleic acids, at least 100,000-folds in a few hours. This method is useful for diagnosis of viral infections caused by HIV-1, HIV-2, CMV, human papilloma virus, HSV, hepatitis B, C, and D viruses, morbillivirus, echovirus, rhinovirus, measles virus, rotavirus, etc. The PCR is useful specifically for detection of:

- latent and integrated sequences of viruses, such as retrovirus, herpes virus, papilloma viruses, and other viruses and
- viruses present in low concentration in clinical specimens.

## Viral Serology

Viral serology is based on detection of specific viral antibodies in serum of the infected human host. A wide number of serological tests are used for demonstration of specific viral antibodies in patient's sera. These include hemagglutination inhibition (HI) test, neutralization test (NT), indirect fluorescent antibody (IFA) test, ELISA, RIA, latex agglutination test (LAT), and Western blot.

The detection of virus-specific immunoglobulin (IgM) antibody in serum indicates a recent primary infection. This is because IgM antibodies appear in the serum during first 2 or 3 weeks of primary infection. A fourfold increase in the antibody titer between the serum collected during the acute phase of the disease and during the convalescent phase, 2–3 weeks after acute phase, is suggestive of seroconversion. An anamnestic or secondary antibody response occurs during reinfection or recurrence of viral infection later in life. The

serum antibody titer usually remains high in individuals who suffer frequent recurrence of the disease, such as herpes virus.

- HI test is used for detection of viruses that agglutinate red blood cells of chickens, guinea pigs, human, or other mammals. Antibodies present in serum prevent viruses to bind and to agglutinate the new blood cells. The HI test is used for diagnosis of infections caused by orthomyxoviruses.
- NT is based on inhibition of infection by the antibody and that of CPEs of the viruses in tissue culture cells. The neutralization antibody response is usually virus and strain specific. The highest dilution of serum preventing infectivity is 50% of virus. Serum mixture tested is considered as the titer of the test.
- ELISA is most commonly used for screening of blood samples for hepatitis B and C viruses and HIV.
- IFA, RIA, and LAT are also used for diagnosis of many common viral infections.
- Western blot is most commonly used to confirm infection caused by HIV, initially diagnosed by ELISA.

### Key Points

The viral serology has following uses:

- It is used to identify the virus and its strain or serotype.
- It is used to determine whether viral infection is an acute or chronic infection, or primary infection or reinfection.
- It is used for diagnosis of viral infections that cause diseases of long duration.
- It is used for diagnosis of infections caused by viruses that are difficult to culture.

The limitations of serological tests in viral diseases are the following:

1. The presence of antiviral antibody in serum only indicates infection but cannot determine whether it is recent or old. Demonstration of IgM antibodies or demonstration of a fourfold increase in the antibody titer between acute and convalescent sera indicates only recent infection.
2. The serological tests may be associated with false-positive or false-negative reactions. The serological cross-reaction may occur between different viruses, giving rise to false-positive reactions. Formation of immune complexes in serum may give rise to false-negative reaction as observed in viral infection caused by hepatitis B virus.

# Bacteriophages

## Introduction

Bacteriophages are bacterial viruses. They are the viruses that infect bacteria. They are obligate intracellular parasites that multiply inside bacteria by making use of some or all of the host biosynthesis machinery. They are also called *phages*. These extra-chromosomal genetic elements usually survive outside a host cell due to the presence of a nucleic acid genome surrounded by a protein coat. Phages occur widely in nature in close association with bacteria and are distributed widely in the soil, feces, and in other substances in the environment. They are associated with transmission of genetic material from one bacterium to another.

The activities of bacteriophage were first described by Twort in 1915, who described it as an infectious agent that distorted the appearance of the colonies of staphylococci. Subsequently, d'Herelle in 1979 demonstrated the lytic activities of the culture filtrate on bacterial colonies. He suggested that the lytic agent was a virus and gave it the name bacteriophage (*phage*: to eat).

## Morphology

Most of the phages consist of single, linear, and double-stranded DNA genome (Fig. 54-1). This genome is surrounded by a protein coat known as phage capsid. Large phages usually consist of a head and a tail. The head encloses the genome, and the tail is used as an organ of attachment as well as the conduit

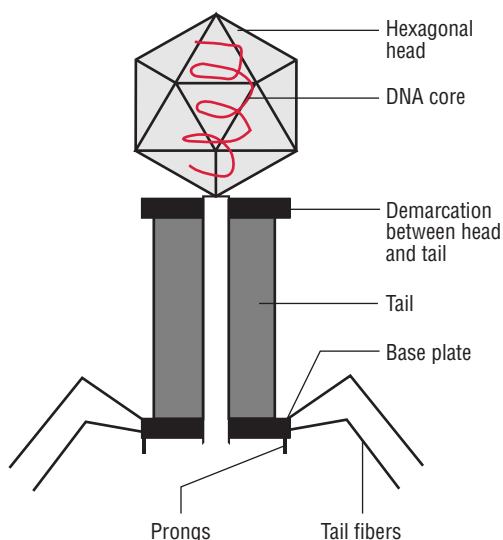

FIG. 54-1. Schematic diagram of a bacteriophage.

through which phage DNA passes into the host cell. The best-studied phages are the T-even phages (T2, T4, T6, etc.) that infect the bacteria *Escherichia coli*. These phages are traditionally considered as the prototype for describing the morphology of bacteriophages. Phages are tadpole-shaped with a hexagonal head and a cylindrical tail.

- **Head:** All phages contain a head structure, which can vary in size and shape. It is icosahedral (20 sides) or filamentous in shape. The size of the head measures between 28 and 100 nm in length. The capsid of bacteriophage head encloses a compartment that contains the nucleic acid, which in most of the phages is a double-stranded DNA molecule. This DNA is protected against degradation by environmental nucleases by virtue of its location inside the bacteriophage head. However, a group of phages that specifically infect male strains of *E. coli* contains only RNA. The capsid or protein coat of a virus is composed of individual proteins known as capsomeres.
- **Tail:** Many but not all phages have tails attached to the phage head. The tail consists of a hollow tube through which the nucleic acid passes during infection. The tail of complex phage like T4 is surrounded by a contractile sheath, which contracts during infection of the bacterium, and a terminal tail plate. The spikes and tail fibers both originate from the tail plate and specifically bind to receptors on the outer membrane of the bacterial cell wall.

## Key Points

- Phages vary considerably in their morphology. Phages that are spherical or filamentous and that possess single-stranded DNA or RNA have also been described.
- Phages show high host specificity. They usually inhabit the intestinal microbial flora of humans and animals.
- They pass through filters, which hold back the bacteria.
- These are inactivated by boiling.

## Life Cycle

Phages exhibit two different types of life cycle:

- **Lytic cycle:** also known as virulent cycle. In this cycle, intracellular multiplication of the phage results in the lysis of host bacteria, resulting in release of progeny virions.
- **Lysogenic cycle:** also known as temperate cycle. In this cycle, phage DNA becomes integrated with the bacterial genome and replicates with the bacteria synchronously without causing any harm to the host cell.

## Lytic Cycle

The lytic cycle of a virulent bacteriophage shows the stages of (a) adsorption, (b) penetration, (c) synthesis of the phage components, and (d) release of progeny phages.

**Adsorption:** Adsorption is the first stage and is a specific process. This stage depends upon the susceptibility of the bacterium to the specific phages. The specificity of the phage is determined by the presence of chemical receptors on surface of the bacteria. Adsorption occurs by random collision and is dependent upon concentration of both susceptible bacteria and the phage. It is a very rapid process and under optimal conditions is completed within minutes.

The sites of the receptors for bacteriophage in bacteria are different and may be situated in different layers of the cell wall or on the surface structure. For example, bacteriophage receptors are found on the outer membrane of the cell wall of *E. coli*, in the Vi antigen of *Salmonella*, in glycosylated teichoic acid of *Bacillus subtilis*, and in portions of outer membrane of the cell wall of Gram-negative bacteria.

Adsorption is a specific biochemical reaction; hence bacteriophages can infect only certain host bacterial cells. This process is so specific that it is used to classify bacteria within a given species. Bacterial strains having the same bacteriophage receptors are classified together. When the numbers of phages adsorbed is less, it may only affect the permeability of the membrane. Lysis of the host cell occurs only if an adequate number of phages invade the bacterium.

Infection usually does not occur in the absence of adsorption. However, infection of the bacterium directly by naked phage nucleic acid can occur, and this process is known as **transfection**.

**Penetration:** Adsorption is followed by penetration of phage nucleic acid into the bacterial cell. Phages with contractile tails behave as hypodermic syringes, injecting the phage DNA into the bacterial body through the hollow core (Fig. 54-2). Penetration through the cell wall is facilitated by an enzyme lysozyme present in the tail core that produces a hole on the bacterial cell wall. The phage DNA then passes through the central tail core into the host cytoplasm, while the empty protein capsid remains attached to the cell surface. More than one phage can adsorb to a host cell and inject its DNA. If more bacteriophages are adsorbed, they make so many holes in the cell wall that it causes lysis of the cell, a phenomenon called **lysis from without**.

The empty head and tail of the phage, after penetration, remain outside the cell surface as the empty shell or ghost. After entry, the phage DNA is rearranged to a circular form, and this process is known as **circulation of phage DNA**.

**Synthesis of phage components:** Synthesis of phage components begins immediately after penetration of the phage nucleic acid. **Early proteins** are the first products to be synthesized. These early proteins include the enzymes, such as nucleases, synthetic enzymes, and RNA polymerase. These early proteins are essential for the building of complex molecules peculiar to the phage.

Subsequently, **late proteins** are synthesized, which include (a) protein subunits of phage, (b) structural proteins necessary for the virion self-assembly, (c) enzymes involved in maturation, and (d) proteins used in the release of bacteriophages from the

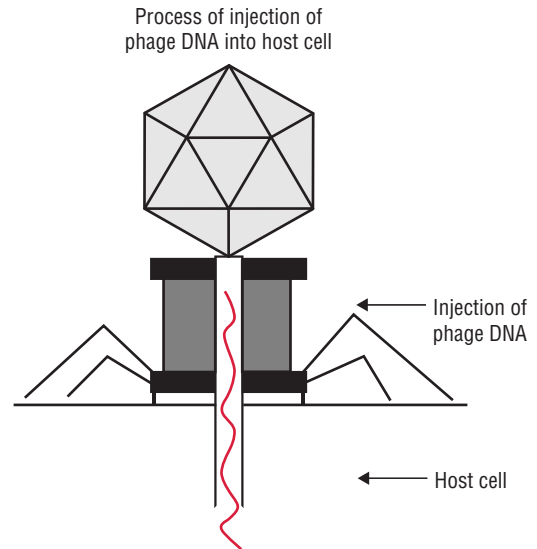

FIG. 54-2. Process of injection of phage DNA into host cell.

cell. During this period, the synthesis of bacterial proteins, DNA, and RNA stops. It is noteworthy that phage DNA, head proteins, and tail proteins are synthesized separately in the bacterial cell.

**Assembly and maturation:** The protein subunits of the phage head and tail aggregate spontaneously to form the compact capsid. The DNA is condensed into a compact polyhedral shape and packaged into the head. The assembly of the phage component into the mature infective phage particles is known as maturation.

**Release of progeny phages:** New mature progeny phages are released by lysis of the bacterial cells. During the replication of phages, the bacterial cell wall is weakened by lysozyme. Finally, the cell wall bursts as a result of osmotic pressure. This is known as **lysis from within**.

The interval between the infection of a bacterial cell and the first release of mature daughter phages is known as the **latent period**. The interval between the entry of phage nucleic acid into the bacterial cell and the appearance of the first infectious intracellular phage particle is known as the **eclipse phase**. The average yield of daughter phages from the infected bacterial cell is known as the **burst size**. The period during which the number of infectious phages released rises is known as the **rise period**.

Lytic cycle is enumerated by a plaque assay. A **plaque** is a clear area, which results from the lysis of bacteria. Each plaque arises from a single infectious phage.

## Lysogenic Cycle

Infection with every phage does not result in lysis of the host cells. Unlike virulent phages, which cause lysis of the host cell, some phages (such as temperate phages) integrate into the genome of the bacterial chromosome without causing any lysis of the bacteria. The integrated phage nucleic acid is known as the **prophage**. The prophage behaves like a segment of the host chromosome and multiplies synchronously with it. This phenomenon is known as **lysogeny**. The bacterium that carries a prophage within its genome is called **lysogenic bacterium** and such phages are called **lysogenic** or **temperate phages**.

**Lysogeny:** After infection by a temperate phage, the DNA from the temperate phage enters the host cell, which inside the cell forms a circle and by a single recombinant event becomes integrated into the DNA of the bacterium. The host bacterial cell, now called the lysogenic cell, replicates the phage DNA or prophage every time it divides. Sometimes, during the multiplication of lysogenic bacteria, the phage may become excised from the bacterial chromosome. The excised prophage can initiate a new lytic cycle resulting in release of daughter phage particles. These daughter phage particles also infect other bacterial cells and make them lysogenic. This is known as spontaneous induction of prophage.

All lysogenic bacteria on exposure to ultraviolet rays, hydrogen peroxide, and nitrogen mustard can also be induced to shift to the lytic cycle. A lysogenic bacterium is resistant to reinfection by the same or related phages. This is called as **superinfection immunity**. During lysogeny, the prophage confers certain new properties on the lysogenic bacteria. This is known as **lysogenic** or **phage conversion**. The examples of phage conversions are as follows:

- 1. Phage-mediated conversion of somatic antigens of *Salmonella*:** This occurs when a large number of temperate phages of *Salmonella* modify antigenic properties of somatic O antigen. For example, *Salmonella* Anatum (antigenic formula: 3,10:e, h:1,6) when lysogenized by a temperate phage shows a new antigenic formula (3,15:e, h:1,6), which is an antigenic formula of *Salmonella* Newington.
- 2. Toxicity of *Corynebacterium diphtheriae*:** The presence of prophage beta ( $\beta$ ) is responsible for production of toxin in *C. diphtheriae*. Removal of the prophage makes the bacteria nontoxic. Similarly, nontoxic *C. diphtheriae* can be made toxic by lysogenization with  $\beta$  phage.
- 3. Toxicity of *Clostridium botulinum*:** Toxin production in *C. botulinum* type C and D is determined by the presence of phages CE $\beta$  and DE $\beta$ , respectively. Elimination of the phages abolishes the toxicity of the bacillus.
- 4. Transduction:** Bacteriophages may act as carriers of gene from one bacterium to another. This is known as transduction. This phenomenon has been described in many bacteria and is recognized as one of the main mechanisms of transfer of genetic material among bacteria in nature. This has been discussed in detail in Chapter 7.

Table 54-1 summarizes the comparison of multiplication of bacteriophages and viruses.

## Uses of Bacteriophages

Bacteriophages have following uses:

- They are convenient model for study of virus host interaction.
- They play an important role in transmission of genetic information by process of transduction.
- They are used as cloning vectors for genetic manipulations.
- They are used for phage typing.

## Bacteriophage Typing

Different strains of a serologically or otherwise identical species of bacteria are susceptible to one or more different bacteriophages. When a suspension of phages is deposited on the lawn culture of a susceptible bacterium, an area of clearing occurs after incubation due to lysis of the susceptible bacteria by the phages. These zones of lysis are called **plaques**. The shape, size, and nature of plaques are characteristic for different phages. Since a single phage particle is capable of producing one plaque, plaque assay can be used for titrating the number of viable phages in preparation. On the basis of this phenomenon, many bacterial species can be divided into various phage types. Phage typing has been used in epidemiological study of infections or outbreaks caused by *Staphylococcus aureus*, *Salmonella* spp., *Vibrio cholerae*, and many other bacteria.

Different phages are available, which show difference in their specificity for genus, species, or strains. Examples are (i) genus-specific bacteriophages for *Salmonella*, (ii) specific bacteriophages for all members or strains of *Bacillus anthracis*, and (iii) for all members of *V. cholerae* biotype classical (e.g., Mukherjee's phage IV). Mukherjee's phage IV lyses all strains of *V. cholerae* biotype classical, but not *V. cholerae* biotype Eltor.

Phage typing of *S. aureus* is a pattern method in which a set of standard phages is employed for intraspecies typing of staphylococci. A strain of *Staphylococcus* may be lysed by a number of phages. Hence, the phage type of a strain is designated by the number of the different phages that lyse it. Phage typing of *Salmonella* Typhi is carried out by using prophage, which is active against only fresh isolates of *S. Typhi* possessing the Vi antigen.

TABLE 54-1

Comparison of multiplication of bacteriophages and viruses

Stage	Bacteriophages	Animal viruses
Attachment	Tail fibers attach to cell wall proteins	Attachment sites are plasma membrane proteins and glycoproteins
Penetration	Viral DNA is injected into host cell	Capsid enters by endocytosis or fusion
Uncoating	Not required	Enzymatic removal of capsid proteins
Biosynthesis	In cytoplasm	In nucleus (DNA viruses) or cytoplasm (RNA viruses)
Genome integration	Lysogeny	Latency; slow viral infections; cancer
Release	Host cell lysed	Enveloped viruses bud out; nonenveloped viruses rupture plasma membrane

# Poxviruses

## Introduction

Poxviruses are the largest and most complex viruses that occur in humans, birds, animals, and insects. These viruses, which belong to family Poxviridae, include a large group of DNA viruses that are morphologically similar and share a common nucleocapsid protein.

## Classification

The family Poxviridae, based on whether they infect insect or vertebrate hosts, has been classified into two subfamilies, Chordopoxvirinae and Entomopoxvirinae. The subfamily Chordopoxvirinae contains viruses that infect vertebrate hosts and include eight genera, of which at least four genera cause diseases in humans. These genera are as follows:

**Orthopoxvirus:** The genus *Orthopoxvirus* includes the poxviruses of mammals, such as smallpox (variola), vaccinia, monkeypox, cowpox, buffalopox, rabbitpox, mousepox, and camelpox viruses.

**Parapoxviruses:** These include the viruses of ungulates that may cause occasional infections in humans. These viruses are orf viruses, pseudocowpox virus, deerpox viruses, and bovine papular stomatitis virus.

**Yatapoxviruses:** These include tanapox viruses and yabapox viruses that are found mainly in Africa.

**Molluscipoxviruses:** These include molluscum contagiosum virus.

Most of the poxviruses that cause diseases in humans belong to the genera *Orthopoxvirus* and *Parapoxvirus*. Smallpox and molluscum contagiosum viruses are specific human pathogens, whereas other poxviruses cause rare zoonotic infections in humans. The poxviruses causing infections in humans are listed in Table 55-1.

## Variola (Smallpox) Virus

Smallpox caused by variola virus has been eradicated from the world in 1980 following an intensive worldwide campaign by the World Health Organization (WHO). However, the possible use of smallpox virus as an agent of bioterrorism is the main concern now.

## Properties of the Virus

### ► Morphology

Variola virus shows following features:

- The variola virus is a large, brick-shaped virus measuring  $300 \times 200 \times 200$  nm, almost visible by light microscopy.
- The virion consists of protein (90%), lipid (5%), and DNA (3%).
- The viral genome consists of a large, double-stranded, linear DNA that is fused at both ends. The DNA measures 130–375 kbp in size and has a terminal loop.
- The extracellular virion possesses two envelopes, while the intracellular virus has only one envelope. The outer envelope

TABLE 55-1

Human infections caused by poxviruses

Virus	Diseases
Variola	Smallpox
Vaccinia	Used for smallpox vaccination In patients with eczema causes <i>eczema vaccinata</i> and in patients with immunodeficiency causes progressive vaccinia
Monkeypox	A disease similar to smallpox
Cowpox	A localized disease, such as milker's node
Orf	Localized lesion, such as a single chronic granulomatous lesion with a central ulcer
Molluscum contagiosum	A self-limiting condition with localized lesions of the skin Causes chronic and extensive skin lesions in patients with HIV
Tanapox	Localized lesions, such as a single, pock-like vesicular lesion on the skin
Yabapox	Localized lesions
Pseudocowpox	Localized lesions

that encloses the extracellular virion consists of host cell lipids and several virus-specific proteins including hemagglutinins. These virions consist of a large number of proteins (more than 100), at least 10 of which show enzymatic activity needed for replication of the genome.

- The virus consists of many enzymes that facilitate in the synthesis, polyadenylation, and methylation of viral messenger RNA (mRNA).

### ► Viral replication

Poxvirus replication is complex. Among the DNA viruses, they are unique in that the complete replication cycle of the virus occurs in the cytoplasm of the host cell. The virus encodes the enzymes required for mRNA and DNA synthesis essential for genetic replication. The virus encodes and carries all proteins necessary for synthesis of mRNA. The virus also encodes proteins for other functions, such as DNA synthesis and immune escape mechanisms. Finally, the virions are assembled and acquire their envelopes by budding from the cell membrane as they are released from the cell.

### ► Other properties

**Susceptibility to physical and chemical reagents:** Variola virus is most stable at low temperature and low humidity. It remains viable for months at room temperature, if protected from sunlight and in the cold or when freeze-dried for years. It is resistant to action of 50% glycerol and 1% phenol. Even though enveloped, the virus is not susceptible to ether, hence is not inactivated by ether. It is susceptible to ultraviolet light and other irradiations and is also readily inactivated by formalin and oxidizing disinfectants.

**Antigenic properties:** Smallpox virus has a single serotype, which was responsible for successful vaccination against the disease. All poxviruses including vaccinia viruses have a common nuclear protein antigen. These poxviruses contain at least 20 different antigens, such as LS antigen, agglutinin, and hemagglutinin.

## Virus Isolation and Animal Susceptibility

### ► Chick embryo

Both variola and vaccinia viruses grow in the chick embryos. They produce pocks on chorioallantoic membrane (CAM) of 11–13 days' old chick embryo within 48–72 hours.

### Key Points

- **Variola virus** produces small, shiny, white, convex, non-necrotic, and nonhemorrhagic pocks.
- **Vaccinia viruses** produce larger, irregular, grayish, necrotic, pock lesions, some of which may be hemorrhagic.

### ► Cell culture

Variola virus can be grown in chick embryo cells, monkey kidney, and HeLa cells. Unlike the vaccinia virus, which

produces cytopathic effects (CPEs) rapidly within 24–48 hours, the variola virus produces CPEs very slowly. The CPEs consist of Guarnieri bodies, which are eosinophilic inclusion bodies that consist of aggregation of virus particles in matrix. These can be demonstrated in stained preparations.

### ► Laboratory animals

Variola virus causes experimental infection only in monkeys. Intranasal infection of monkeys by variola virus causes smallpox in monkeys with generalized skin lesions. Scarification of cornea of rabbit with variola virus causes keratitis with demonstration of characteristic Guarnieri bodies in the stained smears of cornea.

## Pathogenesis and Immunity

### ► Pathogenesis of small pox

Smallpox caused by variola virus is acquired by respiratory route through inhalation of nasal, oral, or pharyngeal droplets. The infection can also be acquired by direct contact with infected skin or fomites. The virus enters the human host through the mucous membranes of the upper respiratory tract. The poxviruses encode many proteins, which initially stimulate host cell growth and then lead to cell lysis and viral spread, thereby facilitating their replication in the cells, lysis of infected cells, and viral spread.

The virus replicates at the site of inoculation and spreads to lymph nodes draining the site of mucosal entry. The virus replicates in the lymphoid tissues, causes transient viremia, and infection of the reticuloendothelial cells. This is followed by a secondary phase of multiplication in these cells, leading to a secondary viremia. This results in clinical manifestations of the disease, which manifests as fever and other toxic manifestations. The viruses then enter the skin, localize in the blood vessels of the skin, and produce characteristic rash of the smallpox. The rash is due to the replication of virus in the skin followed by the damage caused by cytotoxic T cells, damaging the virus-infected cells.

### ► Host immunity

Variola infection is characterized by development of both humoral and cellular immunities. Humoral immune response includes the appearance of hemagglutination inhibition (HI), complement fixing (CF), and neutralizing (NT) antibodies within first to third week of infection. The HI and CF antibody levels usually decrease within a year, whereas NT antibodies persist longer, for many years and decades after infection. Humoral antibodies are not protective. Cell-mediated immunity plays an important role in controlling and resolving the disease. Virus-specific T cells control the spread of viruses by causing lysis of infected cells in the reticuloendothelial cells in the skin. An attack of smallpox gives complete protection against reinfection. Vaccination confers immunity, which lasts about 10 years.



## Clinical Syndrome

Variola virus causes smallpox, the disease which is now extinct.

### ► Smallpox

The incubation period varied from 10 to 14 days. The prodromal phase, which correlated with the phase of viremia, was the first to appear. Onset of disease was sudden. The condition manifested as sudden onset of fever, severe headache, nausea, pharyngitis, body malaise, and backache. An exanthematous rash would appear on the palate, tongue, and pharynx during the later part of the prodromal stage.

The smallpox rash was characterized by skin lesions that are in the same stage of evolution, unlike those lesions seen in chickenpox. The lesions in chickenpox appear in successive waves and in various stages, such as vesicles, pustules, and scabs.

The skin lesions first appear on the face and extremities and then spread centrifugally to the trunk. These lesions begin as macules and then develop into papules, vesicles, pustules, and finally crusts during a period of approximately 17 days. The lesions heal with formation of characteristic scarring.

Overwhelming toxemia was the usual cause of death in patients with smallpox. There were two variants of smallpox: variola major and variola minor. The variola major was associated with a fatality rate of 25–30%, while variola minor was associated with a low fatality rate of less than 1%. In addition, flat smallpox and hemorrhagic variola were the unusual manifestations of smallpox in some patients, and were usually fatal.

## Epidemiology

The world is free of smallpox.

### ► Geographical distribution

The last case of naturally occurring smallpox was detected in Somalia in 1977. The last recorded case in humans, which was due to an accidental laboratory infection, was reported in England in 1978. The WHO in 1980 declared that smallpox was eradicated from the world. At present, the only remaining known virus isolates are stocked in the laboratories at the Center

for Disease Control and Prevention (CDC) in the United States and at the Vektor Institute in Russia. However, during 1990s, it was learned that the smallpox virus has been used by some countries in their biological warfare program. It is not known how many countries still possess the virus in their laboratories.

### ► Reservoir, source, and transmission of infection

Smallpox was a highly infectious disease. Respiratory secretions and exudates of the skin lesions were the most common sources of infection. The disease was most commonly transmitted by inhalation of respiratory droplets from smallpox patients. The patients were highly infectious during the first week of rash, once fever had started. The features of the smallpox that contributed to its total eradication are summarized in Box 55-1.

## Laboratory Diagnosis

Smallpox was usually diagnosed clinically. The main criteria for clinical diagnosis of smallpox included:

- febrile prodromal phase occurring 1–4 days before the onset of rashes;
- characteristic smallpox lesions of the skin (deep, firm, round), which could be umbilicated or confluent; and
- skin lesions in same stage of development on any part of the body.

### ► Specimens

Skin lesions, such as vesicular fluid, were the specimens of choice.

### ► Microscopy

Electron microscope, if available, was used for direct demonstration of typical virus particles in clinical specimens. It was useful to differentiate a smallpox virus from that of the chickenpox. The Guarnieri bodies, the characteristic eosinophilic inclusion bodies, can be demonstrated in stained preparation of the clinical specimens by light microscopy.

### Box 55-1 Features of the smallpox that contributed to its total eradication

1. Smallpox was the first disease to be eradicated by vaccination program due to the availability of an effective vaccine.
2. A safe, stable, economical, and easy to administer smallpox vaccine was available.
3. Presence of scar indicated the successful vaccination against smallpox.
4. There was only a single serotype of variola virus; hence immunization by vaccines protected against all cases of smallpox.
5. Human and other animal poxviruses share common antigenic determinants. Safe vaccines prepared from animal poxviruses could also be used for vaccination against humans.
6. Smallpox exhibited strict host specificity to humans. Humans were the only reservoirs of infection. No animal reservoirs or vectors were incriminated.
7. The clinical manifestations of smallpox were consistently typical; hence cases could be detected and diagnosed easily.
8. These facilitated detection of human cases of smallpox and implementation of preventive measures to prevent transmission of infection to other susceptible human hosts.
9. Subclinical infections did not occur and also chronic carriage of the virus did not occur. The source of infection was a patient with smallpox who could be easily detected in the community and treated, and preventive measures were ensured.

## ► Isolation of the virus

Isolation of the virus in the laboratory is carried out by inoculation in the chick embryo and in cell culture. This is necessary for rapid and accurate identification of poxvirus infections.

**Embryonated egg:** Inoculation of vesicular fluid into the CAM of the chick embryo is a reliable method for detection and identification of variola virus. The virus produces characteristic pocks after 48–72 hours of inoculation. The variola pocks are smaller, whereas vaccinia pocks are large with necrotic centers. The monkeypox and cowpox produce well-marked hemorrhagic lesions, whereas tenapoxvirus, molluscum contagiosum, and the Parapoxvirus do not show any growth on the CAM.

**Cell culture:** Human and nonhuman primate cells, such as monkey kidney and HeLa cells, are used for isolation of virus from clinical specimens. Viruses are detected by the presence of Guarnieri bodies, the characteristic CPE produced by the variola virus. Unlike the vaccinia virus, which produces the CPE rapidly within 24–48 hours, the variola virus produces the CPE very slowly.

Tenapoxvirus and parapoxviruses grow poorly, whereas molluscum contagiosum does not grow at all in the cell cultures.

## ► Serodiagnosis

Serological tests were useful to confirm the diagnosis of poxvirus infection. Indirect immunofluorescent antibody test and HI, CF, and NT tests are available for demonstration of serum antibodies that appear after first week of infection.

## Treatment

No specific antiviral agents are available against variola virus. Methisazone is of some value against some poxviruses. It is recommended only for chemoprophylaxis but not for treatment. Vaccinia immune globulin is recommended for treatment of all complications except postvaccinated encephalitis. Although smallpox has been eradicated worldwide, concern still exists about the possible occurrence of smallpox through bioterrorism.

## Prevention and Control

Smallpox was the first disease to be eradicated by successful immunization program. Empirical preventive measures against smallpox had been used in India and China even before the first millennium. The practice of variolation carried out by intentional inoculation with some virulent strains of variola to prevent against variola infection spread from India to the Old World and subsequently East Europe in the eighteenth century. This procedure of variolation became very popular in Europe till it was replaced by vaccination introduced by Jenner 1796.

The variolation conferred lifelong immunity in vaccinated individuals. It was a risky procedure and was associated with a mortality rate of approximately one-tenth of that seen in individuals with naturally occurring disease. Moreover, inoculated individuals were capable of transmitting smallpox to susceptible individuals for sometime after variolation.

In 1960s, the WHO formulated a concept program for global eradication of smallpox. The disease was then present in 44 countries with a global incidence of around 10 million cases annually. By use of highly potent and stable vaccine, rapid identification of outbreaks, and carrying out ring vaccination in all contacts of a person who are infected (refer the box “Vaccine”), the disease was finally eradicated in 1977 when the last case of endemic smallpox was detected in Somalia.

## Vaccines

**The smallpox vaccine** is a live preparation of vaccinia virus propagated on the skin of cows. The vaccine is applied by scarification, which causes a local pustule that subsequently heals with formation of scab. Subsequently, the virus is grown on the skin of calves to reduce the risk of transmitting syphilis and other diseases during vaccination. Originally, Edward Jenner inoculated with pustular material containing the cowpox virus.

Vaccinia virus used as a vaccine replicating at the site of inoculation produces local erythematous maculopapules. These lesions subsequently vesiculate and finally heal by producing a scab over a period of 10–14 days. Finally, resolution of the lesions takes place by formation of pustule followed by scaling and healing. The resolution of the disease is associated with development of immunity to variola infection that persists for up to 10 years.

## Vaccinia Virus

Vaccinia virus is unique in that it is an artificial virus and does not occur in nature as such. Vaccinia virus was used as the smallpox vaccine. Edward Jenner originally used the cowpox virus for vaccination against smallpox. During subsequent years, the original virus strain was maintained by means of arm-to-arm inoculation, and was maintained as dry material on threads. Over a period of time, the virus mysteriously underwent some permanent changes from its original cowpox form in the strain of vaccinia now used in vaccines. This vaccinia virus could be readily differentiated from fresh isolates of cowpox and smallpox viruses.

Vaccinia virus is now being extensively studied in greater detail than variola, as it is safer to work with (Fig. 55-1). The virus is also being used as a vector for development of recombinant vaccines.

Both vaccinia and variola viruses show similarity in their morphology. They, however, can be differentiated by their growth properties and host range.

## Key Points

Vaccinia virus can be cultured *in vitro* on CAM. The virus is identified by its characteristic pock lesion on the CAM. The vaccinia virus produces relatively larger, irregular, flat, and necrotic lesions, some of which may be hemorrhagic (Table 55-2).

Vaccinia virus has recently been shown to be closely related to the New World orthopoxviruses, Cantagalo, and Aracatuba viruses.

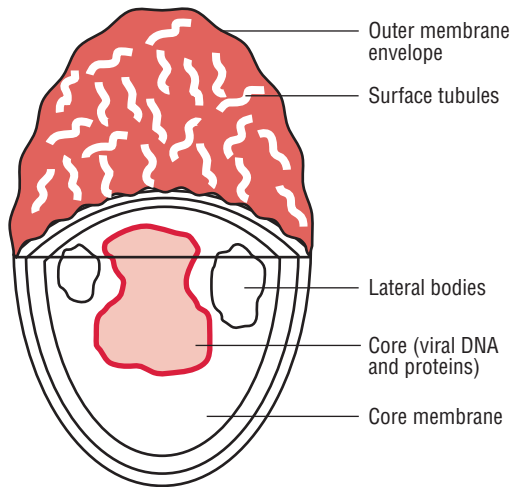

FIG. 55-1. Schematic diagram of structure of a vaccinia virus.

Vaccinia virus, which is used for vaccination, can also cause infection in humans. Vaccinia causes infection by accidental inoculation of the skin. At the site of inoculation, the lesion begins as maculopapular rash, progressing to vesicles, pustules, and finally leading to formation of scab. The lesion heals with formation of marked scarring. Vaccinia virus in patients with eczema causes *eczema vaccinata* and in patients with immunodeficiency causes progressive vaccinia.

## Monkeypox

Monkeypox can cause infection in humans and produce a disease similar to smallpox. This virus was first isolated in 1958 from captive monkeys in Copenhagen. First human infection with this virus was described in the early 1970s.

Cases of monkeypox have been described as a rare zoonotic infection in West and Central Africa, especially in Zaire. The subsequent cases of monkeypox were reported in North America in 2003. The origin of the infection was traced to exotic rodents imported from Africa. Monkeypox infection is acquired by handling infected animals, such as monkeys and squirrels. Person-to-person transmission is unusual.

Clinically, monkeypox cannot be distinguished from smallpox. The condition manifests with development of a

generalized pustule, rash, fever, and toxemia. Electron microscopy is useful to demonstrate the virion particles in clinical specimens for diagnosis of the condition.

## Buffalopox

Buffalopox, believed to be caused by vaccinia virus, occurs among buffaloes in India. In the infected buffaloes, the viruses produce pustular lesions on the teats and udders of lactating buffaloes. The individuals, such as milkmen, coming in contact with these infected buffaloes suffer from the infection. The lesions usually develop on the hands and faces of the milkmen.

Buffalopox appears to be distinct from variola and vaccinia viruses. Smallpox vaccine does not confer protection against infection by buffalopox.

## Cowpox

Human infection with cowpox is usually an occupational hazard. Cowpox resembles antigenically variola and vaccinia viruses but can be differentiated by the hemorrhagic lesions it produces on CAM and rabbit skin.

Cowpox infection in cows produces ulcers on the teats and udders. It may spread to other cows and humans during the process of milking. Natural cowpox infection has also been noted in wild animals kept in zoos including cheetahs and elephants and also in domestic cats. Rodents or cats but not cows have been suggested as the primary host of cowpox infection.

Milker's node or paravaccinia is an occupational disease acquired by humans during the process of milking of infected cows. The common lesions include small ulcerating nodules (Fig. 55-2). The condition presents as painful and hemorrhagic lesions on the hands and face (Color Photo 55) associated with pyrexia and other constitutional disturbances. The virus is distinct from cowpox and grows in bovine kidney cell culture, but not in embryonated eggs.

## Orf

Orf is an infection of humans caused by virus of contagious pustular dermatitis of sheep and goats. In humans, the disease

TABLE 55-2

Differences between variola virus and vaccinia virus

Property	Variola virus	Vaccinia virus
Isolated from	Humans	Origin unknown
Pocks on CAM	Small, white	Large, grayish, and hemorrhagic
Ceiling temperature on CAM	37.5–38.5°C	41°C
Growth on rabbit skin	–	+ or ++
Thymidine kinase sensitivity	+	–
Pathogenicity for baby mice	Low	High
Polypeptide pattern	Character of variola	Character of vaccinia
Host range	Narrow host range (only humans and monkeys)	Broad host range (includes rabbits and mice)



**FIG. 55-2.** Umbilicated nodular lesions over the finger and wrist—milkmaid's nodules (Courtesy: Thappa DM. *Textbook of Dermatology, Venereology and Leprology*. 2nd ed. India: Elsevier; 2005, p. 76, Fig. 7.12.).

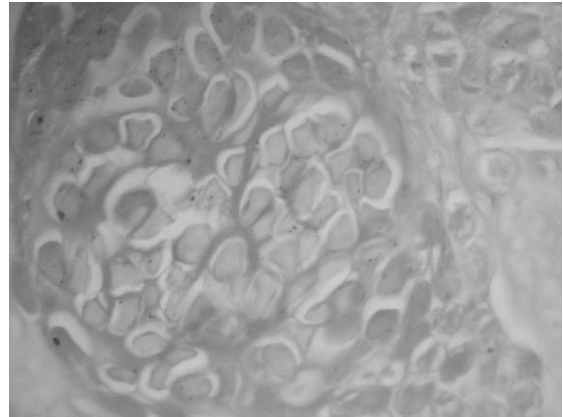

**FIG. 55-3.** Molluscum contagiosum inclusion bodies (×1000).

occurs as a single chronic granulomatous lesion with a central ulcer. The lesions usually present on hands, forearm, or occasionally on the face. The lesions heal without forming any scars. The virus resembles paravaccinia virus morphologically.

### Molluscum Contagiosum

Molluscum contagiosum is a poxvirus unique to humans. The virus is spread by close contact, often through sexual contact. The virus causes a disease of the skin usually seen in children and young adults. It causes small, pink, papular pearl-like benign tumors of the skin or mucous membranes. These lesions are present on the epidermis and occur on most parts of the body except on soles and palms. Lesions are more commonly found on the trunk and anogenital areas. This is a self-limiting condition and the condition generally resolves over a period of time.

Molluscum contagiosum in patients with HIV may cause chronic and extensive skin lesions. Sections of the nodular lesions show hyaline acidophilic inclusion bodies called *molluscum*

*bodies*. Their bodies are large and measure 20–30  $\mu\text{m}$  in size and are composed of large numbers of virion particles embedded in a protein matrix. These inclusion bodies can be seen in the cells of stratum corneum and the stratum granulosum (Fig. 55-3).

Humans are the only susceptible host. The virus cannot be grown in embryonated eggs, tissue cultures, or animals.

### Tanapox

Tanapox virus was first isolated from the cases of febrile illness that occurred along the Tana river in Kenya during 1950s. The virus produces single, pock-like vesicular lesion on the skin, which usually do not progress to form pustules. This lesion is most commonly seen on the upper part of the body. The virus is acquired by insect bite from monkeys and other wild animal reservoirs. It is antigenically not related to other poxviruses. The virus grows in human and monkey tissue culture but does not grow in embryonated egg.

### Yabapox

Yabapox virus produces large benign tumors in monkeys. It causes benign histiocytomas 5–20 days after muscular or subcutaneous inoculation to monkeys. Such lesions have been reported in persons handling affected monkeys.

### CASE STUDY

All doctors and nurses want to be vaccinated by smallpox vaccine in a hospital because of a sudden threat of bioterrorism this year. Since there is a limited supply of smallpox vaccine, the hospital authorities formulate a guideline to vaccinate only those medical and paramedical staff who were not vaccinated earlier.

- Which year the vaccination by smallpox vaccine was stopped in India?
- Which age population in India will be most susceptible group to smallpox in case of a potential threat of bioterrorism?
- After vaccination, at what point the staff receiving the smallpox vaccine will be considered to be fully protected from smallpox?
- How will you diagnose smallpox that occurs in susceptible persons in the laboratory?

# Papovaviruses

## Introduction

The family Papovaviridae consists of papovaviruses, which are a group of viruses containing small, enveloped, icosahedral capsid with a double-stranded, circular DNA. The term *papova* is derived from the first two letters of the names of the viruses (*pa*, papillomaviruses; *po*, polyomaviruses; and *va*, vacuolating agents). The family is divided into two genera *Papillomavirus* and *Polyomavirus*. Currently, the genus *Papillomavirus* is separated into a new family Papovaviridae, and the genus *Polyomavirus* into a new family Polyomaviridae.

The papovaviruses encode proteins that promote cell growth. They induce both lytic infections and tumors (benign or malignant). These viruses are capable of causing lytic, chronic, latent, or transforming infections depending on the host cells infected.

## Human Papillomaviruses

Human papillomaviruses (HPVs) are the causative agents of papillomas, which are the benign tumors of squamous cells or warts on the skin. These are also associated with cancerous conditions in humans, such as cervical carcinoma. HPVs causing diseases in humans are summarized in Table 56-1.

## Classification

Based on DNA homology, tissue tropism, and association with oncogenesis, the HPVs have been classified into 16 groups (A–P), containing at least 70 types.

TABLE 56-1

### Human infections caused by papovaviruses

Virus	Diseases	
Papillomavirus	Skin warts	
	Benign head and neck tumors	
	Anogenital warts	
	Cancerous conditions (oral premalignant lesions and oral squamous cell carcinoma, intraepithelial cervical neoplasia and cancer)	
	Recurrent respiratory papillomatosis	
Polyomavirus		
	BK virus	Renal diseases (hemorrhagic cystitis and urethral stenosis)
	JC virus	Progressive multifocal leukoencephalopathy

## Properties of the Virus

### ► Morphology

Human papillomaviruses show following features:

- They are double-stranded DNA virus without any envelope.
- The viruses are slightly larger than polyomaviruses and measure 50–55 nm diameter.
- They have an icosahedral capsid, composed of 72 capsomeres.
- The viral genome is a supercoiled, double-stranded DNA composed of approximately 3000 base pairs (bp). The DNA encodes seven to eight early genes (E1–E8) and two late (L1 and L2) genomes. All these genes are present in a single strand, that is the “+” strand. Two of the early genes E6 and E7 are implicated in carcinogenesis, whereas E1 and E2 participate in DNA replication.

### ► Viral replication

Papillomaviruses show tropism for epithelial cells of the skin and mucous membranes. The viruses during their replication in epithelial cells are dependent on the specific factors that are present in sequential differentiated states of epithelial cells.

The early genes of the virus are responsible for growth of cells and facilitate replication of viral genome during cell division. The virus-induced cell growth causes thickening of the basal and prickle cell layer of stratum spinosum. The late genes encode for the expression of structural proteins, which are present in the differentiated upper layers of the skin. This causes the tissues to be excreted with the dead cells of the upper layer.

### ► Antigenic and genomic properties

The HPVs show a widespread diversity. Based on the homology between their genomes, more than 100 distinct HPVs have been recognized. Certain HPV types show distinct predilection for infecting certain tissues. Approximately 30 types of HPVs infect the genital tract: HPV-6 and HPV-11 causing the genital warts. HPV types 1–6 primarily cause skin warts.

## Virus Isolation and Animal Susceptibility

Human papilloma viruses do not grow on any cell culture. Hence, cell cultures are not useful for diagnosis of HPV infections.

## Pathogenesis and Immunity

Human papilloma viruses show high degree of host specificity. They show a high predilection for the skin and also for mucous membrane. HPV infection is acquired by close contact, and the infection is initiated by infections of the skin or mucous membranes. Tissue tropism and manifestation of the disease depend on the HPV type that causes disease (Table 56-2).

### ► Pathogenesis of human papilloma virus infections

After infection, the virus replicates in the squamous epithelium of the skin to cause warts and in the mucous membrane to induce epithelial proliferation, such as oral, genital, and conjunctival papillomas. The warts occur as a result of virus-caused cell growth and thickening of the basal and prickle layers of the stratum spinosum as well as the stratum granulosum.

The presence of the koilocytes is the hallmark of the HPV infections of the skin. These koilocytes are the enlarged keratocytes with well-demarcated halos surrounding small nuclei. The HPV infection always causes a localized infection and the warts usually resolve spontaneously possibly as a result of immune response.

TABLE 56-2

Clinical syndromes associated with HPV

Syndromes	HPV types
<b>Cutaneous syndromes</b>	
<i>Skin warts:</i>	
Plantar wart	1, 2, 4
Common wart	1, 2, 4, 7, 26, 29
Flat wart	3, 10, 27, 28, 41
Epidermodysplasia verruciformis	5, 8, 9, 14, 15, 17, 19, 20, 21–25, 36, 38, 46
Warts in organ transplant patients	75, 77
Hand warts of meat and animal handlers	7
<b>Mucosal syndromes</b>	
<i>Benign head and neck tumors:</i>	
Laryngeal papilloma	6, 11
Oral papilloma	2, 6, 11, 16
Conjunctival papilloma	11
Keratoacanthoma	37
<i>Anogenital warts:</i>	
Condyloma acuminatum	1, 2, 6, 10, 11, 16, 30, 44, 45
Cervical intraepithelial neoplasia, cancer	11, 16, 18, 31, 33, 35, 42–44

## Key Points

- Certain types of HPV are associated with dysplasia and may become cancerous with the action of cofactors.
- Human papilloma virus-16 and HPV-18 are known to cause cervical papillomas and dysplasia. Integrated HPV DNA, rather than plasmid-like DNA, had been demonstrated in more than 85% cases of cervical carcinoma.
- The E6 and E7 proteins of these two viruses have been identified as oncogenes. These oncogenes have been found to interfere with the normal function of regulatory proteins, such as p53, p16, and TRb, thereby facilitating the outgrowth of the tumors cells.

Human papilloma virus has also been associated with development of oral premalignant conditions as well as malignant conditions in humans. HPV-16 as well as HPV-18, HPV-33, and HPV-35 have been linked with (a) verruciform proliferation in the oral cavity, (b) oral premalignant lesions, and (c) oral squamous cell carcinoma.

### ► Host immunity

The exact mechanism responsible for resolution of papillomas is not known. Cell-mediated immunity, however, appears to play an important role in the resolution of the disease. The conditions that depress cell-mediated immunity, such as in patients with HIV and those receiving immunosuppressive therapy, give rise to exacerbation of HPV infection and leads to more severe manifestation of the disease.

## Clinical Syndromes

Human papilloma virus infection causes: (a) cutaneous warts, (b) benign head and neck tumors, (c) genital warts, and (d) cancerous conditions in humans (Table 56-2).

### ► Cutaneous warts

Cutaneous warts are commonly caused by HPV-2, HPV-4, and HPV-7. Warts usually develop on the hands and feet after incubation period of 3–4 months depending on the HPV type and the site of infection. They may appear flat, plantar, or dome shaped. The plantar and flat warts are most common in children and young adults. Wart is usually a benign and self-limiting condition, which resolves during the course of time.

### ► Benign tumors of head and neck

These include oral papilloma, laryngeal papilloma, and conjunctival papilloma.

Oral papillomas are usually single but may be multiple. They are sessile, verrucous, and white with raised borders. These lesions usually appear on the lips, hard palate, or gingiva. Focal epithelial hyperplasia or *Heck disease* is commonly caused by HPV-13 and HPV-32. This condition manifests as multiple, smooth, and sessile nodules present on the mucosal surface of the lower lip or on the buccal mucosa. This condition was described in North American people.

Laryngeal papillomas are life-threatening conditions in children, caused by HPV-6 and HPV-11. This is the most common benign epithelial tumor of the larynx.

► **Genital warts**

Genital warts or *condyloma acuminata* is caused by HPV-6 and HPV-11. The condition typically manifests as solitary or multiple cerebriform and pink lesions, which appear more commonly on the nonkeratinized mucosa than on the keratinized mucosa. These genital lesions may also spread to the oral cavity during sexual activity involving orogenital contact.

► **Cancerous conditions**

Certain types of HPV—commonly, HPV-16 and less frequently, HPV-18, HPV-33, HPV-35—have been associated with oral premalignancy and malignancies in humans. These conditions are associated with verruciform proliferations in the oral cavity. Oral premalignant lesions and oral squamous cell carcinoma caused by HPV-16 and HPV-18 are most commonly associated with intraepithelial cervical neoplasia and cancer. The conditions progresses from mild to moderate neoplasia to severe dysplasia or carcinoma *in situ* during a period of 1–4 years.

**Epidemiology**

► **Geographical distribution**

HPV infections are found worldwide.

► **Reservoir, source, and transmission of infection**

Human papilloma viruses have been detected in the oral cavity of estimated 6–10% of children and adolescents, and in 5–80% in healthy adults. HPVs are found in genital secretions and skin sheddings, which contain virus. Infected humans are the main source of infection. Asymptomatic shedding of viruses in body secretions facilitates transmission of infection to other human hosts.

The infections are transmitted primarily by skin-to-skin contact and by genital contact. They are transmitted:

- most commonly by sexual contact (HPV-16, HPV-18);
- by direct contact through abrasions in the skin and mucosa; and
- by passage through infected birth canal as for laryngeal papilloma (types 6 and 11).

**Laboratory Diagnosis**

The diagnosis of wart is made by histopathological examination. Demonstration of hyperplasia of the prickle cells and excessive production of keratin (hyperkeratosis) is diagnostic of the condition. Human papilloma virus infection can be detected by the demonstration of round coalesced cytotc squamous epithelial cells occurring in clumps in Papanicolaou smears. Cell cultures are not useful, because HPVs do not grow in cell lines. Serology is rarely used. The typing of virus isolates may be carried out by immunohistochemical detection of HPV structural proteins.



**Molecular Diagnosis**  
DNA probe and polymerase chain reaction (PCR) are more sensitive techniques for detection of HPV in cervical swabs of tissue specimens.

**Treatment**

Warts are regressed during the course of time over a period of months to years. The warts can be removed by surgical cryotherapy, electrocautery, or chemical reagents.

**Prevention and Control**

No specific preventive measures are available against HPV infection. Avoidance of direct contact with infected warts may prevent transmission. Safe sexual practice will be useful to prevent sexual transmission of HPV.

**Polyomaviruses**

Simian virus 40 (SV40) is the prototype polyomavirus studied extensively for eliciting different properties of the virus. The human polyomaviruses, such as BK and JC viruses, usually cause asymptomatic infection in humans. Polyomaviruses (*poly*, many; *oma*, tumor) are smaller viruses than papillomaviruses, measuring 45 nm in diameter. They are nonenveloped viruses with a 72-capsomere icosahedral capsid.

Viral genome is a double-stranded DNA containing less nucleic acid, approximately 5000 bp. The genomes of polyomaviruses (BK, JC, and SV40) are similar to each other. The genome is divided into early, late, and noncoding regions. The early region codes for nonstructural transformation protein, while the late region codes for three viral capsid proteins, such as VP1, VP2, and VP3. The noncoding region contains the site of the origin of DNA for replication. Differences between HPV and polyomaviruses are summarized in Table 56-3.

Different polyomaviruses show different host specificities. Human polyomaviruses, such as JC and BK, probably enter through the respiratory tract, and then subsequently infect lymphocytes and the kidneys. The BK viruses cause latent infection of the kidney and of B cells. The pathogenesis of the human polyomavirus infection in humans depends on the immune status of the host. In the immunocompetent host, the replication of viruses is inhibited. Suppression of immunity in patients receiving organ transplantation or suffering from AIDS results in reactivation of latent JC and BK viruses. In these patients, reactivation of viruses leads to shedding of viruses and symptomatic infection. The reactivation of BK viruses causes severe urinary tract infection with excretion of the virus in urine. Reactivation of JC viruses causes viremia and spread of the virus to the central nervous system (CNS), causing infection of the CNS.

TABLE 56-3

## Differences between human papillomaviruses and human polyomaviruses

Properties	Papillomavirus	Polyomavirus
Virion size (diameter)	55 nm	45 nm
Genome size	$8 \times 10^3$ bp	$5 \times 10^3$ bp
Coding information	On one strand	On both strands
Oncogenic potential	Yes	Uncommon
Result of natural infection	Benign tumor	Inapparent
Target tissue	Surface epithelia	Internal organs
Transform cells <i>in vitro</i>	Rarely	Yes
Genome in transformed cells	Episomal in warts; integrated in carcinoma	Integrated
Viruses infecting humans	Human papillomavirus	BK and JC viruses; SV40
Clinical syndromes	Skin warts, genital warts laryngeal papillomas, cervical carcinoma	Progressive multifocal leukoencephalopathy and nephropathy in transplant recipients

All the polyomaviruses (BK, JC, and SV40) are known to cause tumor in animals, such as hamsters. These viruses, however, are not associated with any tumors in humans.

Primary infection by human polyomaviruses is mostly asymptomatic in immunocompetent host. In immunocompromised host, the tissues are reactivated causing many serious diseases.

Both JC and BK viruses are ubiquitous. Most people are infected by these two viruses by the age of 15 years. Both the viruses are probably transmitted by respiratory route.

- BK virus is associated with hemorrhagic cystitis in the bone marrow recipients. It also causes urethral stenosis in patients receiving kidney transplant.
- JC virus was first isolated from the brain of a patient with Hodgkin's disease, who developed progressive multifocal leukoencephalopathy (PML). PML is a subacute demyelinating disease of the CNS and is usually fatal. This disease occurs usually in immunocompromised patients including the patients with AIDS, Hodgkin's disease, and chronic lymphocytic leukemia.
- The SV40 shows oncogenic potential in newborn hamsters, but is not associated with any human disease. The SV40, however, has a public health importance. Earlier, some batches of polio vaccines, which were prepared in the simian cell culture were contaminated with undetected SV40 virus

in the primary monkey cell cultures. However, no SV40-related tumors have been reported so far, although many people were vaccinated with these SV40 contaminated polio vaccines.

Electron microscopy is useful to detect JC virus in brain tissue from the cases of PML and from urine of kidney transplant recipients. Immunoperoxidase and *in situ* immunofluorescence are rapid detection methods for detection of viral antigen in brain tissue obtained by biopsy or at autopsy.

BK polyomavirus is isolated from urine by culture in human diploid fibroblasts; JC virus is isolated from urine and brain tissue by culture in human fetal glial cell culture. Hemagglutination inhibition test is performed to differentiate these two viruses.

No specific antiviral treatment is available for polyomavirus infections in humans. Prevention of polyomavirus infection is difficult due to ubiquitous presence of these viruses.



### Molecular Diagnosis

DNA probe and PCR are newer, sensitive methods for detection of BK virus and JC virus in the urine, cerebrospinal fluid, or biopsy tissue.



### CASE STUDY

A 35-year-old female commercial sex worker with history of sexual contact with many clients is diagnosed to be suffering from cervical cancer. The cancer is linked to a viral etiology which is found worldwide.

- Name the causative viral agent of cervical cancer.
- How will you diagnose the condition in laboratory?
- Describe the methods of prevention of the condition.



# Herpesviruses

## Introduction

The herpesviruses are large, enveloped DNA viruses. They exhibit many common features, such as similar morphology of virions, basic mode of replication in the host cells, and capability to establish latent and recurrent infections. All herpesviruses are structurally similar. The herpesviruses measure 120–200 nm in diameter. The virus has a characteristic morphology and consists of four distinct structural elements: (a) DNA core, (b) capsid, (c) tegument, and (d) envelope.

The DNA core consists of a linear double-stranded DNA (dsDNA) molecule with molecular weight varying from 125 to 229 kilobase pairs (kbp). The core is surrounded by an icosahedral capsid containing 162 capsomeres. This is enclosed by a glycoprotein-containing envelope. Between the envelope and capsid is an amorphous structure called tegument, which contains viral proteins and enzymes that initiate replication.

Envelope is the outermost component and is composed of lipids. It is derived from the modified host cell nuclear membrane through which the naked virions project during replication. It carries surface spikes about 8 nm long. As enveloped viruses, the herpesviruses are sensitive to fat solvents, such as alcohol, chloroform, ether, and bile salts.

Herpesviruses replicate in the host cell nucleus, and both replication and assembly occur in the nucleus. The herpesvirus encodes for several glycoproteins that facilitate viral

attachment, fusion, and immune evasion. The virus buds from nuclear membrane and is released by exocytosis and cell lysis.

## Classification

Herpesviruses are ubiquitous. All human herpesviruses are included in the family Herpesviridae, which is divided into three subfamilies based on viral characteristics, pathogenesis of the disease, and clinical manifestation of the disease (Table 57-1). At least eight important herpesviruses are known to cause infection in humans (Table 57-2). They are officially designated as human herpesvirus types 1–8, but the common names are still used.

## Herpes Simplex Virus

Herpes simplex viruses (HSVs) are extremely host-adapted viruses that can cause a wide variety of illness in infected human hosts. There are two types of the HSVs: (a) herpes simplex virus type 1 (HSV-1) and (b) herpes simplex virus type 2 (HSV-2). Both the types are closely related in their DNA homology, antigenic determinants, and tissue tropism and disease symptoms, but differ in epidemiology. HSV-1 is transmitted primarily by contact with infected saliva, whereas HSV-2 is transmitted by sexual contact or by genital tract infection to newborn from an infected mother.

TABLE 57-1

Classification of human herpesviruses

Subfamily	Scientific name	Common name	Site of latency
Alphaherpesvirinae	Human herpesvirus 1	Herpes simplex virus type 1	Neurons
	Human herpesvirus 2	Herpes simplex virus type 2	Neurons
	Human herpesvirus 3	Varicella zoster virus	Neurons
Gammaherpesvirinae	Human herpesvirus 4	Epstein-Barr virus	Lymphoid tissues
	Human herpesvirus 8	Kaposi's sarcoma-related virus	—
Betaherpesvirinae	Human herpesvirus 5	Cytomegalovirus	Monocytes and lymphocytes in secretory glands
	Human herpesvirus 6	Human B cell lymphotropic virus	Lymphoid tissue
	Human herpesvirus 7	RK virus	Lymphoid tissue

TABLE 57-2

Human infections caused by human herpesviruses

Human herpesviruses	Diseases
Herpes simplex virus (HSV)-1	Acute herpetic gingivostomatitis, acute herpetic pharyngotonsillitis, herpes labialis, herpes encephalitis, eczema herpeticum, and herpetic whitlow
HSV-2	Genital herpes, neonatal infection, and aseptic meningitis
Varicella zoster virus (VZV)	Chickenpox and herpes zoster
Epstein-Barr virus (EBV)	Infectious mononucleosis, EBV-induced tumors, such as Burkitt's lymphoma, other B-cell lymphoma, and nasopharyngeal carcinoma. Duncan's syndrome, lymphoproliferative syndrome, oral hairy leukoplakia
Cytomegalovirus (CMV)	Congenital CMV infection, acquired CMV infection, CMV infection in immunocompromised patients, and CMV infection in immunocompetent adult hosts
HSV-6	Roseola infantum, may also cause mononucleosis syndrome and lymphadenopathy
HSV-7	Roseola infantum and febrile seizures in children
HSV-8	Associated with Kaposi's sarcoma, body cavity lymphoma, and Castleman disease

## Properties of the Virus

### ► Morphology

Herpes simplex viruses show following features:

- The HSVs like other herpesviruses are large, enveloped, icosahedral viruses.
- Both HSV-1 and HSV-2 are structurally and morphologically similar. They, however, are distinguished antigenically by using type-specific monoclonal antibodies, restriction endonuclease patterns of their genome DNA, and the site of lesions.
- The virus contains a dsDNA. The genomes of both HSV-1 and HSV-2 are similar in organization and show a higher degree of sequence homology. They, however, can be differentiated by restriction enzyme analysis of viral DNA.
- The unique feature of the DNA genome is that it encodes for as few as 80 polypeptides.
- Half of the proteins are required for replication of viruses, whereas other proteins help in interaction of the viruses with different host cells and immune response. HSV encodes for at least 11 glycoproteins that serve as (a) viral attachment proteins (gB, gC, gD, gH), (b) fusion proteins (gB), (c) structural proteins, (d) immune escape proteins (gE, and gI), and (e) other fractions.

### ► Viral replication

Herpes simplex virus (HSV) grows very rapidly in infected cells, requiring only 8–16 hours for completion. The virus infects most types of cells in human hosts and usually causes lytic infections of the fibroblasts and epithelial cells. After entry into the cell, the virion is uncoated, genome is released, and the genome DNA enters into the nucleus. The mRNA is transcribed by host cell RNA polymerase and then translated into early nonstructural proteins. Subsequently, the viral DNA polymerase replicates the genome DNA, during which synthesis of early proteins is stopped but synthesis of late structural proteins begins. These late proteins are transported to the nucleus where assembly of virion occurs.

The virion acquires its envelope by budding through the nuclear membrane. It also causes latent infections of neurons

by the presence of multiple copies of HSV-1 DNA in the cytoplasm of infected neurons.

### ► Other properties

Like other enveloped viruses, HSVs are sensitive to treatment with acid, fat solvents, detergents, and drying. They are readily inactivated in the conditions prevalent in the gastrointestinal tract.

## Virus Isolation and Animal Susceptibility

### ► Chick embryo

The virus grows on the chorioallantoic membrane of the embryonated egg and produces small, white, shining, non-necrotic pocks measuring less than 0.5 mm in diameter. Both HSV-1 and HSV-2 show cross-reaction.

### ► Cell culture

Herpes simplex virus grows in a variety of primary and continuous cell lines. The viruses grow readily on HeLa cells, Hep-2 cells, human embryonic fibroblasts, and rabbit kidney cells.

## Key Points

- HSV typically produces Cowdry type A acidophilic inclusion bodies, which are well-defined foci with heaped-up cells in the infected cell lines.
- Many strains of HSV also produce syncytial and giant cells in the infected cells.
- The virus kills the cells rapidly in tissue culture.

A cell line that expresses beta galactosidase after infection with HSV is a new approach for isolation and identification of the virus in the cell lines. Addition of a chromotropic substrate allows the detection of enzymes in the infected cell.

## Pathogenesis and Immunity

HSV shows three unique biological properties: neurovirulence, latency, and reactivation.

- **Neurovirulence:** The viruses have capacity to invade and multiply in the nervous system.
- **Latency:** Establishment and maintenance of latent infection in the nerve cell ganglion is the unique property of the virus. HSV-1 affects most commonly the trigeminal ganglion, whereas HSV-2 affects the sacral nerve root ganglion (S2–S5).
- **Reactivation:** Reactivation and replication of latent HSV can lead to overt or covert recurrent infections and excretion of HSV. Reactivation can be caused by a variety of stimuli, including fever, trauma, emotional stress, sunlight, etc. In immunocompetent patients, HSV-1 reactivates more frequently in the oral cavity rather than on the genital parts, but HSV-2 reactivates eight to ten times more frequently in the genital parts as compared to orolabial infection. In immunocompromised patients, reactivation by either HSV-1 or HSV-2 is more frequent and more severe. The viruses cause disseminated infection in individuals with HIV-related disease and in people with impaired T-cell immunity, such as organ transplant recipients.

### ► Pathogenesis of herpes simplex virus infection

Herpes simplex virus causes disease by direct cytopathologic effects. The infection is initiated by direct contact and depends on the infected tissues whether oral, genital, or brain, etc. The infection occurs by inoculation of virus into susceptible mucosal surfaces, such as the oropharynx, conjunctiva, or cervix or through small abrasions on the skin.

The viruses infect cells of ectodermal origin, the cells coming in contact with infected material, such as saliva or genital secretion. Viruses replicate at the site of entry in the skin or mucous membrane. The neuroinvasiveness (the ability of virus to invade the brain), neurotoxicity (ability to multiply in the brain and destroy the brain), and its latency (ability to remain in a nonreplicating stage in the dorsal root ganglia of the central nervous system, or CNS) are the properties of HSV that influence the course of infection in an infected host.

The virus multiplies locally with cell-to-cell spread. The virus replicates in the infected cells at the base of the lesion and infects the innervating neuron. Subsequently, the viruses travel by retrograde transport to the ganglion, such as the trigeminal ganglion for HSV-1 and the sacral ganglion for HSV-2. The virus then returns back to the initial site of infection and may cause inapparent infection or produce vesicular lesions. Thin-walled umbilicated vesicles—the roof of which breaks down, leaving tiny superficial ulcers—are the typical lesions caused by HSV. These vesicles heal without forming any scars. The vesicle fluid contains infectious virions.

After this retrograde axonal flow from neurons, the viral genomes become latent in the ganglia, particularly those of the trigeminal (HSV-1) and sacral (HSV-2) nerves. No viral particles are produced during this phase of latency. Also, latent infection in neurons does not cause any demonstrable damage in neurons. This latency phase may be reactivated periodically in some individuals, causing recurrent oral and genital lesions.

Various stimuli, such as physical or emotional stress, trauma, fever, and sunlight can induce a recurrence in which

the virus travels back down the nerve, leaving lesions to develop at the skin, at the same spot each time. These stimuli trigger reactivation:

- by facilitating viral replication in the nerve,
- by inhibiting cell-mediated immunity (CMI) transiently, or
- by inducing both the mechanisms.

Thus, recurrences or reactivation of infection can occur in the presence of specific antibodies. However, the recurrent infections are more localized, less severe, and of short duration than the primary infection, due to presence of past memory immune responses.

### ► Host immunity

Immunity is type specific, but some cross-protection may occur. In primary HSV infection, the immunity is characterized by the appearance of specific antibody responses within a few days, followed by a cellular immune response in the second or third week of infection.

Humoral antibodies to HSV-1 increase with age, starting at childhood during which HSV-1 is usually acquired. Antibodies to HSV-2 appear in sexually mature adults, correlating with their degree of sexual activity. The antibodies usually do not prevent recurrence of disease, but reduce the severity of clinical disease. Immunity is incomplete, and both reinfection and reactivation occur in the presence of circulating antibodies.

CMI plays an important role in conferring immunity to HSV infection and facilitates recovery from the infection. Hence, the virus tends to cause more frequent and severe infections in the patients with altered CMI, such as HIV and other CMI-deficient diseases.

Tissue damage occurring in HSV infection is due to a combination of viral pathology and immunopathology. These immunopathologic effects of CMI and inflammatory responses are the major causes of symptoms seen during the disease.

## Clinical Syndromes

Herpes simplex virus causes a wide variety of clinical manifestations. The clinical manifestations depend on (a) the age of patient, (b) immune status of the host, (c) previous immunity of the patient to autologous or heterologous viruses, (d) antigenic type of the virus, and (e) anatomical site of involvement.

Generally, HSV-1 produces the lesions above the waist, and HSV-2 produces lesions below the waist. HSV-1 infection is normally associated with orofacial infections and encephalitis, whereas HSV-2 is associated with genital infections. Primary infection with either virus is typically associated with systemic signs, prolonged duration, increased severity of illness, and more complications.

### ► HSV-1 infections

HSV-1 can cause a wide variety of clinical entities. These include (a) acute herpetic gingivostomatitis, (b) acute herpetic pharyngotonsillitis, (c) herpes labialis, (d) herpes encephalitis, (e) eczema herpeticum, and (f) herpetic whitlow.

**Acute herpetic gingivostomatitis:** Acute herpetic gingivostomatitis is the manifestation of primary HSV-1 infection occurring in children between 6 months and 5 years. Saliva from infected child or an adult is the source of infection. This condition has an incubation period of 3–6 days. The condition has an abrupt onset with high temperature. Gingivitis is the most important manifestation with marked lip swelling and erythematous and friable gums. Vesicular lesions appear on the oral mucosa, tongue, and lips. These lesions subsequently rupture and coalesce together, leaving behind ulcerated plaques. The acute disease lasts for 5–7 days, and the symptoms subside in 2 weeks. Viral sheddings from the saliva may continue for 3 weeks or more.

**Acute herpetic pharyngotonsillitis:** HSV-1 causes pharyngitis and tonsillitis in adults more frequently than gingivostomatitis. The condition manifests as fever, malaise, headache, and sore throat. The vesicular lesions on the tonsils and the posterior pharynx usually rupture to form ulcers. Associated oral and labial lesions can be found in less than 10% of the patients.

**Herpes labialis:** Herpes labialis is the most common clinical manifestation of recurrent HSV-1 infection (Fig. 57-1, Color Photo 56). Pain, burning, and tingling sensation at the site of infection are presenting features. An intraepidermal vesicle that later becomes pustular and ulcerate is the typical lesion. Usually, two or less recurrences manifest each year in most patients. But in some patients, even monthly recurrence is seen.

**Herpes encephalitis:** Herpes encephalitis is an acute febrile disease that is usually caused by HSV-1. This may be a manifestation of primary or recurrent infection with the virus. The infection may have an insidious or an abrupt onset. Focal neurological manifestations, such as seizures, hemiparesis, aphasia, and paresthesia may be seen during acute condition. In some patients, the infection may rapidly progress from stupor to coma to death, without having any localized neurological symptoms.

**Eczema herpeticum:** Eczema herpeticum is seen in children with active eczema. The vesicular lesions appear briefly on previous eczematous areas with extensive ulceration. Subsequently, the infection may be disseminated by blood to the adrenal glands, liver, and other organs, resulting in fatal consequences.

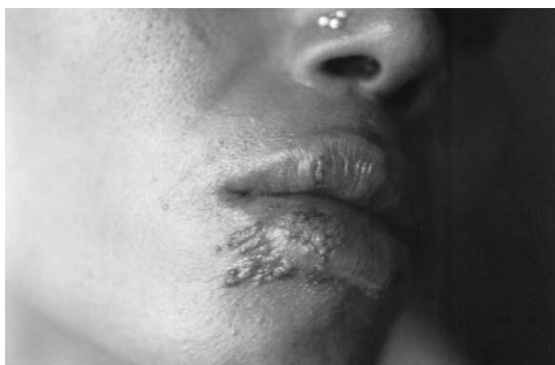

**FIG. 57-1.** Grouped vesicles and erosions over the angle of the mouth—recurrent herpes labialis (Courtesy: Thappa DM. *Textbook of Dermatology, Venereology and Leprology*. 2nd ed. India: Elsevier, 2005, p. 64, Fig. 7.1.).

**Herpetic whitlow:** Herpetic whitlow is an infection of the finger caused by entry of the virus through cuts or abrasions on the skin. The condition often occurs in doctors and nurses who are exposed to patients with HSV infection and to patients who have genital infection. The vesicular lesions are usually produced on the skin of the finger but may also be seen on the skin of the head and neck.

## ► HSV-2 infections

HSV-2 causes (a) genital herpes, (b) neonatal infection, and (c) aseptic meningitis.

**Genital herpes:** Genital herpes is mostly caused by HSV-2 but can also be caused by HSV-1. The latter causes less than 10% of genital infections. Most primary genital infections are asymptomatic. The clinical manifestations of primary genital herpes caused by HSV-1 and HSV-2 are similar, but recurrences are more common with HSV-2.

In symptomatic men, the herpetic vesicles appear in the glans penis, the prepuce, shaft of the penis, and sometimes on the scrotum, thighs, and buttocks. Herpetic proctitis involving the perianal area and rectum are seen in the persons who engage in anal intercourse. In women, the vesicles appear on the external genitalia, labia majora, labia minora, vaginal vestibule, and introitus. The vesicles subsequently rupture, leaving behind extremely painful ulcers. Cervicitis, urethritis, and dysuria may also be present in some women.

In both men and women, the primary infection may be associated with constitutional symptoms, such as fever, headache, malaise, and myalgia. In both the sexes, the ulcerative lesions persist from 4 to 15 days until crusting and re-epithelization occur. The virus continues to shed in the ulcerative lesions for more than 12 days.

Recurrent genital herpes are more common with HSV-2 as compared to HSV-1. The condition is shorter in duration and less severe than the primary genital herpes. Recurrent genital herpes in men may present as one or more numbers of clustered vesicles on the shaft of the penis, prepuce, or glans. Relatively, pain is mild and urethritis is uncommon. The lesions heal in 7–10 days. In women, the vesicular lesions are found on the labia majora, labia minora, or perineum. These lesions are very painful. Fever and constitutional symptoms are uncommon. The lesions heal in 8–10 days.

**Neonatal infection:** Neonatal infection is a most serious and usually fatal disease caused mostly by HSV-2. It usually occurs due to shedding of HSV-2 from the cervix during vaginal delivery. It can also occur from an ascending *in-utero* infection during a primary infection of the mother. The infection can also be acquired postnatally from family members or hospital staff.

Since CMI is poorly developed in neonates, the virus causes a disseminated disease with involvement of liver, lung, as well as the organs of the CNS. The condition has a high mortality of 80%. Progression of the infection to the CNS results in mental retardation or neurological disabilities even with treatment, or may finally lead to death.

**Aseptic meningitis:** Aseptic meningitis may occur as a complication of genital HSV-2 infection.

TABLE 57-3

Differences between HSV-1 and HSV-2

Characteristics	HSV-1	HSV-2
Site of latency	Trigeminal ganglia	Sacral ganglia
Age of primary infection	Young children	Young adults
<b>Diseases:</b>		
Vesicular lesions in the skin	Above the waist	Below the waist, especially the genitalia
Gingivostomatitis	Common	Rare
Pharyngotonsillitis	Common	Rare
Keratoconjunctivitis	Common	Rare
Infection of the CNS	Encephalitis	Meningitis
Infection in neonates	Rare	Skin lesions and disseminated infections
Infection in immunocompromised hosts	Dissemination to visceral organs	No dissemination
Transmission of infection	Contact (often saliva)	Sexual
Growth on CAM	Small pocks	Large pocks
Growth in chick embryo fibroblast	Replicates poorly	Replicates well
Laboratory animals	Less neurovirulent	More neurovirulent
Recurrence	Less chance of recurrence	More recurrence irrespective of site
Resistance to antiviral agents in culture	Less resistant	More resistant

HSV-1, herpes simplex virus type 1; HSV-2, herpes simplex virus type 2; CAM, chorioallantoic membrane.

Differences between HSV-1 and HSV-2 infections are summarized in Table 57-3.

## Epidemiology

Herpes simplex viruses are distributed worldwide.

### Geographical distribution

HSV-1 infection is more common than HSV-2 infection. By the age of 30 years, 80% individuals in high socioeconomic status and 80% in a low socioeconomic status are seropositive. Serum antibodies to HSV-2 begin to appear at puberty, correlating with degree of sexual activity. The HSV-2 infection is a major problem in the United States. It has been estimated that five of every 12 adults are infected with HSV-2. A total of 45 million individuals are infected, with up to 1 million newly infected people added every year.

### Reservoir, source, and transmission of infection

Herpes simplex virus infections are exclusively human diseases. Humans are the only natural reservoirs. No vectors are involved in transmission of the disease. An infected person is a lifelong source and reservoir of the virus. Vesicle fluid, saliva, and vaginal secretions are the important sources of infection for both types of HSV.

HSV-1 infection is transmitted orally through saliva. It is usually transmitted by oral contact, such as by kissing or by sharing of the toothbrushes or other saliva-contaminated items. The HSV infection can also occur following mouth-to-skin contact, with the virus entering through minor abrasions in the skin. Autoinoculation may also cause infection of the eye.

## Key Points

### HSV-2

- HSV-2 is transmitted through sexual contact with infected person.
- The infection can also be transmitted from an infected mother to a child at birth and by autoinoculation.
- The virus is inactivated readily at room temperature and by drying; hence transmission by aerobes or fomites is most unusual.

Children are at risk for acquiring HSV-1 infection, whereas sexually active people are at increased risk to HSV-2 infection. Medical and paramedical staffs on coming in contact with oral and genital secretions are at increased risk for acquiring herpetic whitlow. Immunocompromised individuals and neonates are at high risk for developing life-threatening disseminated disease.

## Laboratory Diagnosis

### Specimens

These include saliva, vesicle fluid, conjunctival fluid, corneal scraping, skin swab, skin scrapings, and cerebrospinal fluid (CSF).

### Microscopy

Light microscopy of the stained infected cell may show ballooning of cells, ground glass nuclei and eosinophilic intranuclear inclusions, and multinucleated giant cells. Electron microscopy can be used for direct demonstration of virions in the negatively stained smears of the clinical specimens.

### ► Direct antigen detection

Direct enzyme immunoassay and direct fluorescent antibody test are useful to demonstrate HSV antigens directly in vesicular fluid, tissue smear, or biopsy.

### ► Isolation of the virus

A definitive diagnosis of HSV infection is made by isolating the viruses in cell cultures.

**Cell culture:** For culture, scrapings of skin vesicles and mucosal lesions are collected, transferred immediately in a vial transport medium, and are carried to microbiology laboratory. After inoculation, HSV produces cytopathic effects (CPEs) within 1–3 days on HeLa cells, Hep-2 cells, and human embryonic fibroblasts. These cells become enlarged and appear ballooned. Some virus strains, particularly HSV-2, cause fusion of infected cells, leading to formation of syncytium. Immunofluorescent staining of infected tissue culture is useful to confirm the diagnosis within 24 hours. Polymerase chain reaction (PCR) is a useful tool to distinguish HSV-1 from HSV-2. Isolated HSV can be typed by biochemical, immunological, and molecular methods.

### ► Serodiagnosis

Serodiagnosis is of little value for diagnosis of primary HSV infection. It is mainly used for epidemiological studies. It is used only to determine postexposure to HSV. It is not useful for diagnosing recurrent infections because rise in antibody titer does not usually correlate with recurrent disease. Also, the serological tests cannot distinguish between HSV-1 and HSV-2 antibodies due to cross-reactivity.

### Molecular Diagnosis

DNA probe and PCR are useful for demonstration of viral genome directly in vesicular fluid, skin scraping, CSF, and other specimens for diagnosis of the disease. PCR shows a higher sensitivity (95%) for detection of HSV-1 DNA in the CSF specimen. PCR is also used to detect asymptomatic shedding or HSV in skin lesions, but is not cost-effective. PCR is also being increasingly used for diagnosing HSV infection of brain by examining the brain biopsy specimen.

- HSV-1 and HSV-2 types can be distinguished from each other by using (a) type-specific antibody, (b) DNA probe analysis, and (c) PCR.
- The DNA maps of restriction enzyme fragments of HSV-1 and HSV-2 are unique, hence can be detected or identified by DNA probe analysis and PCR.

### ► Other tests

#### Histology

**Tzanck smear:** It is useful for the cytological identification of viruses in the scraping obtained from the base of the vesicular lesion. In this procedure, the vesicular lesion is aseptically ruptured, and the base of the lesion is scrapped with a scalpel. The scraping from the base of the lesion is smeared on a glass slide, air dried, fixed, and usually stained

### Laboratory tests for diagnosis of herpes simplex virus infections

TABLE 57-4

Diagnostic methods	Diagnostic features
<b>Microscopy</b>	
Tzanck smear	Presence of multinucleated giant cells with faceted nuclei and homogeneously stained ground glass chromatin (Tzanck cells)
Light microscopy	Eosinophilic intranuclear inclusions
Electron microscopy	Virus particle
<b>Direct antigen detection</b>	
Direct fluorescent antibody and direct enzyme immunoassay	HSV antigens directly in vesicular fluid, tissue smear, or biopsy
<b>Cell culture</b>	
Culture on HeLa cells, Hep-2 cells, and human embryonic fibroblasts	Cytopathic effects within 1–3 days
<b>Serology</b>	
ELISA, CFT, and neutralization test	Not useful for primary infection; only used for seroepidemiological studies
<b>Molecular diagnosis</b>	
DNA probe and PCR	Detects viral genome directly in vesicular fluid, skin scraping, CSF, and other specimens. Standard assay for specific diagnosis of HSV infections of the central nervous system

with Giemsa or Wright stain. Demonstration of typical giant cell or Cowdry type A intranuclear inclusion bodies in the stained smear is diagnostic of HSV infection. This method shows variable sensitivity of 40–80% for diagnosis of HSV. Laboratory tests for diagnosis of HSV infections are summarized in Table 57-4.

### Treatment

Herpes simplex virus infections are among other few non-HIV viral infections that can be treated with antiviral therapy. Treatment with specific antiviral chemotherapy is used to (a) prevent disease and recurrence, (b) treat the infection, and (c) to reduce the clinical course of infection.

**Acyclovir:** It is a synthetic acyclic purine nucleotide analog, which is most commonly used to treat HSV infection. Acyclovir is useful:

- to diminish shedding of viruses,
- to decrease rate of clinical recurrences, and
- to suppress recurrent genital infections.

Oral therapy with acyclovir is usually recommended for primary orolabial and genital HSV infections, which are non-life-threatening. Intravenous acyclovir is recommended for life-threatening and serious HSV infections, such as encephalitis, infections in immunocompromised patients, and occasional severe orolabial or genital cases.

Famciclovir and valacyclovir are other antiviral agents used against HSV.

## Prevention and Control

Prevention of genital HSV infection is difficult because most transmission occurs during subclinical viral shedding. Nevertheless, abstinence from sexual intercourse while the patients have prodromal symptoms or lesions or use of condoms may be useful. But these methods are not fully protective. Prevention of transmission of HSV from mother to infant is also difficult due to presence of asymptomatic primary or recurrent genital infection. In such infected mothers, transmission can be prevented by avoiding vaginal delivery and instead delivering by caesarian section. At present, no vaccine is available for use against HSV.

## Herpesvirus Simiae: B Virus

Herpesvirus simiae, recently designated as *Cercopithecine herpesvirus 1*, was isolated in 1934 by Sabin and Wright from the brain of a laboratory staff, who died from ascending myelitis following bite by an apparently healthy monkey. This virus was named as B virus from the initial of the name of this patient. Since then many cases have been reported in the literature.

Herpesvirus simiae is similar to HSV in many properties. These two viruses are antigenically related, though the antibody against HSV does not protect against herpesvirus simiae infection. Herpesvirus simiae in monkeys usually causes asymptomatic infection. In symptomatic cases, it is associated with formation of vesicles on the buccal mucosa. The lesion ulcerates, shedding the viruses in the ulcer exudate.

The infection in humans is usually acquired by bite of the monkeys. In some cases, it is acquired by handling infected monkey tissues. In humans, the disease is usually fatal. Neurological sequelae are seen in the patients who rarely survive from the condition.

## Varicella Zoster Virus

Varicella zoster virus (VZV) causes two distinct clinical entities in humans: (a) chickenpox (varicella) and (b) herpes zoster or shingles. Chickenpox is acquired by transmission from an infected host to a susceptible host, whereas herpes zoster occurs as a result of reactivation of the latent virus. Contact with a case of zoster or chickenpox may transmit chickenpox but not herpes zoster.

## Properties of the Virus

Varicella zoster virus (VZV) shows following features:

- The virus has the smallest genome of all the human herpesviruses.
- It is an enveloped, dsDNA virus showing many similarities with the HSV.

- The virus like that of the HSV encodes an enzyme thymidine kinase and is susceptible to antiviral drugs. It produces characteristic blister-like lesions and also has the ability to cause latent infections of nervous and recurrent disease. However, unlike HSV, VZV is transmitted mainly by the respiratory secretions.
- VZV shows a replicative cycle similar to that of HSV.

## Virus Isolation and Animal Susceptibility

Varicella zoster virus grows readily in cultures of human fibroblasts, human amnion, or HeLa cells. These cell cultures show an apoptotic effect similar to that seen in HSV-infected cells, but the lesions are less marked than those produced by HSV. Also, the CPE appears after a longer incubation period. In culture, the viruses remain associated with the cells and are not found free in the media. The virus does not grow in chick embryos or in experimental animals.

## Pathogenesis and Immunity

Chickenpox is the primary disease, whereas herpes zoster represents reactivation of a previous infection.

### ▶ Pathogenesis of varicella zoster virus infections

Primary VZV infection occurs in humans when the virus comes into contact with the mucosa of the respiratory tract or conjunctiva. From these sites, the virus enters the blood stream and lymphatic system to the cells of the reticuloendothelial system. After 11–13 days, a secondary viremia occurs and the virus spreads throughout the body and to the skin. In tissues, VZV spreads from cell to cell via direct contact to produce its effects.

After primary infection, the virus migrates along the sensory nerve fibers to the satellite cells of the dorsal root ganglia or cranial nerve ganglia, where it becomes latent. This latency may be permanent, or the virus may become reactivated in old adults or in patients with impaired cellular immunity. On reactivation, the virus replicates and spreads along the nerve fibers to the skin, known as *herpes zoster* or *shingles*.

### ▶ Host immunity

CMI is important in controlling the infection. It limits the progression of the disease and results in early resolution of the disease. The virus causes a disseminated life-threatening and more serious disease in immunocompromised patients with a deficient CMI. Depression of the CMI during life in the old age may cause recurrence of VZV and may cause herpes zoster. Humoral antibodies also play an important role by limiting the spread of the virus in the circulation. CMI also contributes to the immunopathology and symptomatology in the infected host. In some infected adults, it is responsible for more severe manifestations and more extensive cell damage than seen in children.

Immunity following varicella is lifelong; the individual does not suffer from varicella again, but can suffer from herpes zoster despite having immunity to varicella. Immunity is also lifelong in herpes zoster.

## Clinical Syndromes

Varicella zoster virus causes following two distinct clinical syndromes: (a) varicella (chickenpox) and (b) herpes zoster (shingles).

### ► Varicella (chickenpox)

Varicella is one of the five childhood exanthemata along with measles, rubella, rubeola, and fifth disease. Chickenpox is a benign illness of the childhood, which is characterized by an exanthematous varicella rash that occurs following infection with VZV.

Incubation period is about 2 weeks. The condition is normally asymptomatic. In symptomatic cases, the condition manifests as fever and maculopapular rash that progresses within a few hours to thin-walled vesicle on an erythematous base. This vesicle, which is the hallmark of chickenpox, is characteristically surrounded by a red ring. The vesicle, which measures approximately 2–4 mm in diameter, becomes a pustule within 12 hours and begins to ulcerate, after which scabs appear. Successive crops of vesicles appear over 2–5 days and as a result at any given time all stages of the lesions are seen on the skin.

### Key Points

- The skin lesions are characteristically *centripetal* in distribution. They are more commonly present on the trunk than on the extremities.
- Typically, they are also present on the scalp.
- On the mucous membrane, lesions typically occur in the mouth, conjunctiva, and vagina. All these features help to distinguish chickenpox from many other exanthematous diseases. Secondary bacterial infection followed by scarring is the noted complication in the children.

Primary infection in adults is generally more severe than in children. The vesicles heal more slowly; secondary bacterial infections and scarring are more common. The accompanying fever is more prolonged and higher. Interstitial pneumonia, Guillain–Barre syndrome, and Reye’s syndrome may occur in some of the patients.

In pregnancy, VZV tends to cause more serious disease if the mother has not been infected during the childhood. The virus crosses the placenta and causes congenital infection in the fetus. Congenital malformation with hypoplasia of limbs, chorioretinitis, and scarring of skin are seen in the fetus infected during pregnancy.

### ► Herpes zoster

Herpes zoster is a recurrence of latent varicella infection acquired many years earlier. This occurs due to reactivation of the VZV, which has remained latent in one or more sensory ganglia following primary varicella many years earlier. The viruses travel down along the sensory nerve to produce painful vesicles in the areas of the skin (*dermatome*) innervated by the nerves from the affected ganglia. Severe pain in the area innervated by the nerve preceding the appearance of chickenpox-like lesion

is the hallmark of the disease. The rashes are usually restricted to a dermatome. For example, if thoracic nerve supplies are affected, rashes appear most commonly on the chest walls. The rashes are distributed on the scalp and forehead when the ophthalmic nerve of trigeminal ganglion is affected. In more than 50% of the cases, the eye is affected, leading to corneal ulceration, anterior uveitis, and stromal keratitis.

The accompanying pain and herpetic neuralgia is very much severe for up to a few weeks and occurs in about half of the patients over 60 years of age. The pain may persist for months, which may even require surgical ablation of the ganglion.

Zoster of the seventh nerve ganglion may cause Bell’s palsy and Ramsay Hunt syndrome. This is caused by reactivation of virus involving the facial and auditory nerves. Vesicular lesions may develop on the pinna, tragus, in the auditory canal, and on the tympanic membrane. The patient may have nystagmus, vertigo, or facial nerve palsy resembling Bell’s palsy.

Postherpetic neuralgia is a chronic pain syndrome caused by VZV. The condition is characterized by persistence of recurrent pain lasting 30 or more days after the acute infection. This condition occurs in more than 30% of patients, in the older people aged 65 years and above.

Herpes zoster ophthalmicus is the most serious and devastating form of acute herpes zoster (Color Photo 57). The condition occurs due to reactivation of the fifth cranial (trigeminal) nerve. This condition may appear weeks to months after resolution of other symptoms. Postherpetic neuralgia and long-term sequelae are common in this condition.

**Varicella zoster virus infection in immunocompromised patients:** The virus causes more lesions, and a progressive and life-threatening disease in immunocompromised patients and in neonates. The defective CMI in these patients facilitates rapid dissemination of the virus to the brain, lungs, and liver, thereby causing a fatal infection. The condition may occur following primary infection by varicella or by reactivation of latent disease.

## Epidemiology

### ► Geographical distribution

Varicella zoster virus is a highly infective pathogen distributed worldwide.

### ► Reservoir, source, and transmission of infection

Chickenpox is exclusively a human disease. No animal reservoirs are present. A chickenpox or herpes zoster patient is the source of infection. Varicella zoster virus is shed mainly in the respiratory secretions and also in the vesicular lesions of the skin. The infectivity is maximum during the early stage of the disease when the virus is shed in large numbers in respiratory secretions. The buccal lesions and vesicular fluid, which are rich in virus content, are highly infectious and are sources of infection. Scabs do not contain any viruses, hence are noninfectious.

Chickenpox is transmitted primarily by inhalation of respiratory secretions. The infection may also occur by direct



contact with vesicular lesions on the skin. Herpes zoster is a reactivation of latent varicella zoster virus infection, hence is not acquired from an infected patient.

Chickenpox is mainly a disease of children. In herpes zoster infection, people of all ages are affected. The incidence of the disease, however, increases with age, due to the decrease in immune functions that occurs during aging.

## Laboratory Diagnosis

In almost all the cases, diagnosis of chickenpox and herpes zoster is always clinical.

### ► Specimens

These include skin lesion specimens, respiratory secretions, or organ biopsy.

### ► Direct antigen detection

Direct fluorescent antibody test employing antibodies against viral membrane antigen (fluorescent antibody to membrane antigen; FAMA) is used to detect membrane antigen of the virus directly in the skin scrapings and biopsy specimens. The counter-current immunoelectrophoresis using zoster immune serum is also used to detect antigen directly in the vesicular fluid.

### ► Isolation of the virus

Specimens from buccal or skin lesions collected during early stage of the disease are cultured on human amnion, human fibroblast, and HeLa or Vero cells. The VZV produces a CPE similar to that of HSV, but is less conspicuous and takes a long time to develop.

### ► Serodiagnosis

Both indirect fluorescent antibody and enzyme-linked immunosorbent assay are employed to detect serum antibodies against VZV. These tests are useful mainly for epidemiological studies rather than for diagnosis of individual cases.

## Molecular Diagnosis

PCR is a highly sensitive method for detecting of viral genome in skin scrapings or biopsy specimens.

### ► Other tests

**Histology:** The Tzanck smear is useful to detect Cowdry type A intranuclear inclusions and syncytia in VZV-infected cells.

## Treatment

Antiviral drugs are available for treatment of VZV infections. These are acyclovir, famciclovir, and valacyclovir. Treatment with these agents is usually recommended for adults and immunocompromised patients with varicella infection and for patients with herpes zoster infections. Antiviral therapy is usually not indicated for treatment of varicella infection in children.

## Prevention and Control

Prevention of transmission of varicella infection in children is difficult.

### ► Varicella zoster immunoglobulin

Varicella zoster immunoglobulin is prepared by pooling sera from patients convalescing from herpes zoster. High-risk people, such as immunosuppressed patients, are protected from serious disease by administration of varicella zoster immunoglobulin (VZIG). The immunoglobulin is also used for treatment of medical and paramedical personnel exposed to virus, as well as for treatment of newborns of infected mothers showing symptoms within 5 days of delivery. It is, however, not useful as a therapy for treatment of patients suffering from active varicella or herpes zoster disease.

## Vaccines

A live attenuated **varicella vaccine** (*Oka strain*) is being used for protection against VZV. This vaccine was developed by Takahashi in Japan 1974 by attenuating strains of the varicella virus by serial passage in human and guinea pig fibroblast cell lines. The vaccine is given in a single dose for children aged 1–12 years and in two doses at 6–10 weeks' interval for older children.

- The vaccine is safe and protective. It stimulates the production of protective antibody and CMIs.
- The vaccine even confers protection in immunodeficient children.
- It is also used as a prophylactic agent for treatment of people even after exposure to VZV.

## Epstein–Barr Virus

Epstein–Barr virus (EBV) or human herpesvirus 4 (HSV-4) is the causative agent of infectious mononucleosis. Epstein–Barr virus is also the first virus known to be associated with human malignancies, such as Burkitt's lymphoma, other B-cell lymphoma, and nasopharyngeal carcinoma. It also causes other lymphoproliferative disorders in immunodeficient individuals. Epstein–Barr virus is a gamma herpesvirus belonging to subfamily Gammaherpesvirinae. It shows very limited host specificity.

## Properties of the Virus

### ► Morphology

Epstein–Barr virus shows following features:

- It is an enveloped DNA virus. It consists of a genome, a capsid, and an envelope.
- The genome consists of a 172 kbp, linear dsDNA. It is surrounded by an icosahedral capsid composed of capsomeres. Both the capsid and the genome, which form the

nucleocapsid, are enclosed by an envelope containing glycoproteins. The envelope is derived from the outer nuclear membrane of host cell and contains many proteins, which are expressed for different types of infections.

- The viral capsid antigen (VCA) is the most important antigen present in the capsule and is of diagnostic importance. Neutralizing antibodies are produced against the viral membrane antigen. The early antigens (EAs), Epstein–Barr nuclear antigen (EBNA), lymphocyte-determined membrane antigen, and viral membrane antigens are other antigens of diagnostic importance.

The EBV enters B lymphocytes at the site of receptor for the C3 component of the complement. The virus replicates in cytoplasm of the infected epithelial cells and the replicative cycle is similar to that of HSV.

### ▶ Antigenic and genomic properties

Based on differences in the latency nuclear antigen genes, EBV consists of two types EBV-1 and EBV-2, also known as type a and type b strains, respectively. Both the types cause the same degree of clinical illness. They are prevalent throughout the world and can simultaneously infect the same person.

### ▶ Other properties

Epstein–Barr viruses are sensitive to the action of ether and bile salts. They are relatively fragile and do not survive for a longer period outside the human body fluids.

### Virus Isolation and Animal Susceptibility

The virus can grow in human embryonic lung fibroblast culture. The CPE produced by the virus is focal and is associated with refractile ballooning of the cells. The CPE unlike other viruses takes two or more weeks to develop.

### Pathogenesis and Immunity

Epstein–Barr virus in humans can cause either of the following types of infections:

1. Primary infections by replication of viruses in B cells and epithelial cells.
2. Latent infection of B cells and presence of competent T cells.
3. Transformation of B cells to immortal plasmacytoid cells leading to malignancies.

### ▶ Pathogenesis of Epstein–Barr virus infection

Epstein–Barr virus infection first occurs in the oropharynx and then spreads to the blood causing infection of B lymphocytes. The virus is, therefore, present in large numbers in oropharyngeal secretions. Hence, the infection is most commonly transmitted through infected saliva often as a result of kissing.

Therefore, the infectious mononucleosis is also commonly called as the *kissing disease*.

### ▶ Host immunity

The virus infection induces a strong immune response, comprising circulating antibodies against many virus-specific proteins, cell-mediated immune responses, and production of lymphokines. The humoral immunity is characterized by the appearance of IgM antibodies first against the viral membrane antigen, followed by the IgG antibodies, which persist for life. These antibodies against viral membrane antigen confer lifelong immunity against the second attack of infectious mononucleosis. The CMI plays an important role in controlling chronic infection and limiting primary infection.

### Clinical Syndromes

EBV is associated with (a) infectious mononucleosis, (b) EBV-induced tumors, and (c) EBV infection in immunocompromised host.

### ▶ Infectious mononucleosis

This is a clinical syndrome that represents the immunopathogenic response of the host to infection with EBV. It is the classic syndrome associated with primary EBV infection in adolescents and young adults. EBV is the causative agent in approximately 90% of cases of acute infectious mononucleosis. Cytomegalovirus (CMV) is most commonly associated with EBV-negative cases of infectious mononucleosis.

The condition is most often asymptomatic in children younger than 4 years. In symptomatic cases in adolescents and in adults, the condition is characterized by high fever, sore throat, headache, myalgia, nausea, and abdominal pain. The condition is associated with pharyngitis, generalized lymphadenopathy, hepatosplenomegaly, and fatigue. The symptoms are usually present for 2–3 weeks. But fatigue, which is the major complaint, continues to persist.

Epstein–Barr virus infection rarely causes death in immunocompromised patients but may cause neurological complications (meningoencephalitis, Guillain–Barre syndrome, etc.), upper airways obstruction, or splenic rupture.

### ▶ Epstein–Barr virus-induced tumors

Epstein–Barr virus infection is associated with a number of tumors. Endemic Burkitt's lymphoma caused by EBV is a poorly differentiated monoclonal B cell lymphoma of the jaw. It is the most common tumor of childhood in Africa associated with both EBV and falciparum malaria. *Plasmodium falciparum* malaria causes stimulation and proliferation of polyclonal B cells in the presence of EBV infection. The malaria parasite also alters response of T lymphocytes to EBV, apparently contributing to pathogenesis of the tumor.

## Key Points

- Epstein–Barr virus infection is associated with nasopharyngeal carcinoma endemic in Asia and is common in males of Chinese origin. EBV DNA can be demonstrated in the nasopharyngeal carcinoma cells.
- Epstein–Barr virus is also associated with Hodgkin's lymphoma and most non-Hodgkin's lymphoma. EBV genome is demonstrated in Reed Sternberg cells in Hodgkin's lymphoma.

### ► Epstein–Barr virus infection in immunocompromised host

The virus causes most severe diseases in patients who are immunocompromised. In these patients, the EBV causes several syndromes and proliferation disorders including Duncan syndrome, ataxia telangectasia, Wiskott–Aldrich syndrome, and common variable immunodeficiency.

### Epidemiology

Epstein–Barr virus infection occurs worldwide, but since it is not a reportable infection, the exact prevalence of infection is not known.

### ► Geographical distribution

The viral infection is of relatively low transmissibility and does not occur as epidemics. It has been estimated that by age of 5 years, approximately 50% of the population in the United States is infected by EBV. The same appears to be true for other developed countries. In developing countries, 90% of children below 5 years are believed to experience an asymptomatic EBV infection.

### ► Reservoir, source, and transmission of infection

Epstein–Barr virus infection is exclusively a human disease. Humans are the only known reservoirs of the virus. It is present in oropharyngeal secretion, saliva, peripheral blood, or lymphoid tissue of the infected human host. Saliva is the main source of infection. The saliva of people with active infection as well as people with reactivation of a latent infection constitute major source of infection. More than 90% of EBV-infected people intermittently shed the virus in their saliva throughout the life even when totally asymptomatic. The virus causes lifelong infection. The infection is transmitted by:

- saliva through close oral contact during the act of kissing;
- sharing of items, such as drinking glasses, cups, toothbrushes, etc.;
- blood transfusion and by bone marrow transplantation, but rarely.

The possible association of cofactors is suggested to play an important role in the geographical distribution of EBV-associated tumors. Malaria has been suggested as an important

cofactor in the progression of chronic or latent EBV infection to acute Burkitt's lymphoma in Africa. The genetic predisposition of the people in China or the presence of cofactors in the food or environment is believed to be important in facilitating the incidence of nasopharyngeal carcinoma in people living in certain parts of China.

Immunocompromised people, such as patients with AIDS, transplant recipients, and genetically immunodeficient people are at high risk for lymphoproliferation disorders caused by EBV.

### Laboratory Diagnosis

The laboratory diagnosis of EBV-induced infectious mononucleosis is based on the three classic criteria:

- Presence of lymphocytosis.
- Presence of at least 10% atypical lymphocytes in peripheral blood smear.
- Presence of heterophilic antibodies and antibodies to viral antigens.

These criteria are supplemented by direct detection of viral antigens or EBV genomes in clinical specimens.

### ► Specimens

These include lymphoid tissues, nasopharyngeal carcinoma tissue and saliva (for direct detection of viral antigens or EBV genomes), and blood (for serological tests) and peripheral blood (for blood smear).

### ► Direct antigen detection

Direct immunofluorescent antibody using specific viral antibodies is used to detect EBV in clinical specimens.

### ► Isolation of the virus

EBV can be isolated from saliva, peripheral blood, or lymphoid tissue by transformation of normal human lymphocytes obtained from umbilical blood. However, the procedure is tedious and time-consuming, hence seldom used. Attempt has also been made to culture “spontaneously transformed” B lymphocytes from EBV DNA or virus-infected patients.

### ► Serodiagnosis

Epstein–Barr virus infection stimulates production of a wide range of antibodies including the heterophilic antibodies. These heterophilic antibodies are IgM antibodies that recognize Paul–Bunnell antigen on sheep, horse, and bovine RBCs. Therefore, serum from patients with acute mononucleosis agglutinates sheep, horse, or bovine erythrocytes.

### Heterophile antibody test

**Paul–Bunnell test:** Paul–Bunnell test was first described by Paul and Bunnell for demonstration of heterophile antibodies in patients with infectious mononucleosis in 1932. This heterophile antibody, which is an IgM antibody, is not directed

against EBV or EBV-infected cells, but is produced due to polyclonal activation of B cells by EBV. Such heterophilic antibodies are also found in serum sickness during drug reaction and naturally occurring antibodies to the Forssman antigen. These antibodies are absent or present in a very low titer in serum of healthy individuals.

The human blood to be tested is first absorbed by guinea pig kidney and then it is tested for agglutination activities that are directed against horse, sheep, or cow erythrocytes. The serum is inactivated at 56°C for 30 minutes and in doubling dilution is mixed with equal volume of a 1% suspension of sheep RBCs. The test is incubated at 37°C for 4 hours and is examined for agglutination. A serum titer of 100 or greater is considered a positive test and is suggestive of infectious mononucleosis.

Differential absorption of agglutinin with guinea pig and cow red cells is necessary for confirmation of the diagnosis. Cow RBCs absorb infectious mononucleosis heterophile antibodies from serum but not Forssman antibodies. Guinea pig kidney cells absorb Forssman antibodies, but not the infectious mononucleosis heterophile antibodies. Both guinea pig kidney cells and bovine RBCs absorb the antibodies produced in serum sickness. A serum titer of 1:100 after adsorption with guinea pig cells is considered positive and is suggestive of acute infectious mononucleosis.

The heterophile antibodies are present in serum of 40–60% of patients with infectious mononucleosis in the first week of illness and in 80–90% of cases by the third or fourth week. These heterophile antibodies are usually present for 3 months but may persist for even as long as a year.

**Monospot test:** Monospot test is a rapid slide agglutination test, which uses either horse RBCs or bovine RBCs. Bovine RBCs are more specific for acute infectious mononucleosis heterophile antibodies; hence they do not require differential absorption. Monospot test shows a specificity of 63–80%. It may show rare false positive reaction in patients with lymphoma or hepatitis.

### EBV-specific antibody tests

Epstein–Barr virus infection is characterized by development of specific antibodies against different viral antigens, which appear during different stages of infection. Antibodies are produced against viral capsid antigens (VCA), early antigens (EAs), and Epstein–Barr nuclear antigen (EBNAs). Viral capsid antigen and membrane antigens are produced late in the lytic cycle, whereas EBNA is expressed in the latently infected cells. EAs are always expressed early in the lytic cycle.

Indirect immunofluorescence test, ELISA, and Western blot are frequently used methods to detect antibodies against these antigens.

- Demonstration of IgM VCA antibodies as well as antibodies against EAs in the serum indicates current infection with EBV.
- Demonstration of IgG VCA antibodies indicates past infection.
- Demonstration of antibodies to EBNA antigens is also suggestive of past infection.

Serological profile of EBV infections is summarized in Table 57-5.

### Other tests

**Complete blood count:** Presence of atypical lymphocytes is the characteristic feature of infection with EBV. Usually 20–40% of lymphocytes are atypical. These atypical lymphocytes of Downy type III are larger and have a less dense nucleus than normal lymphocytes. Lymphocytosis (more than 50% lymphocytes) is seen in approximately 80–90% of patients. Lymphocytosis is well marked during the second or third week of illness and persists for 2–6 weeks.

### Treatment

No specific treatment is available against acute infectious mononucleosis. Acyclovir has little activity against EBV; it may be useful in high doses for treatment of life-threatening EBV infections. Treatment of the condition is mainly symptomatic.

TABLE 57-5

Serologic profile for EBV infections

Serological parameters	Patient's clinical status					
	Acute primary infection	Chronic primary infection	Past infection	Reactivation	Burkitt's lymphoma	Nasopharyngeal carcinoma
Heterophile antibodies	+	–	–	–	–	–
VCA-IgM	+	–	–	–	–	–
VCA-IgG	+	+	+	+	+	+
EA	±	+	–	+	+	+
EBNA	–	–	+	+	+	+

EBV, Epstein–Barr virus; VCA-IgM, viral capsid IgM antibodies; VCA-IgG, viral capsid IgG antibodies; EA, early antigen; EBNA, Epstein–Barr nuclear antigen.

## Molecular Diagnosis

DNA probe for Epstein-Barr early antigens has been used to detect and identify the EBV mRNA in the nuclei of EBV-infected lymphoid cells. PCR has been developed to detect EBV DNA in plasma during acute infectious mononucleosis. This EBV DNA levels decline during convalescence. They are not demonstrated in latently infected individuals.

## Prevention and Control

Prevention and control of infection is difficult due to widespread prevalence of the virus and intermittent shedding of the virus by the infected individuals throughout the life. Avoidance of contact with saliva and avoidance of kissing children on the mouth are some of the preventive measures. No vaccine is available against EBV infection.

## Cytomegalovirus

Cytomegalovirus or human herpesvirus 5 (HSV-5) is the causative agent of mononucleosis syndrome in symptomatic infection in immunocompetent hosts. It causes pneumonia and more serious diseases in immunocompromised patients than in other individuals. The name is originated from the word *cytomegalo* (large cell virus) and is derived from the swollen cells containing large multinuclear inclusions that characterize these infections.

## Classification

Cytomegalovirus is a member of the Betaherpesvirinae in the subfamily Herpesviridae. The virus shares similar common features in the structure, genome, and potency to cause latent and persistent infections like those of other herpesviruses.

## Properties of the Virus

### ► Morphology

Cytomegalovirus shows following features:

- CMV is the largest herpesvirus measuring 150–200 nm in size.
- It has the largest genome of all the herpesviruses, ranging from 230 to 240 kbp. It is a double-stranded linear DNA virus with 162 hexagonal protein capsomeres surrounded by a lipid membrane.
- CMV is the only beta herpesvirus that has the only class E genome, similar to that present in HSV.

Replicative cycle of CMV is similar to that of other herpesvirus, except that some of the immediate early proteins of the CMV are translated from mRNAs incorporated into the infected cells by the parental virion, but are not translated from the mRNAs synthesized in the newly infected cells.

### ► Antigenic and genomic properties

Human CMV has a single serotype. It does not show any antigenic cross-reaction with CMV of other mammalian species. It shows only minor antigenic cross-reaction with simian CMV.

## Virus Isolation and Animal Susceptibility

Human CMV replicates only in human cells. The virus grows only in diploid human fibroblast cell culture but not in epithelial cell culture. CMV grows very slowly in these cell lines, taking as long as 4–6 weeks to produce characteristic CPEs. The CPE includes foci of swollen refractile cells with cytoplasmic granules, which can be demonstrated by staining. In a stained smear, these cells show multinucleated giant cells containing acidophilic inclusions in the nuclei and cytoplasm.

## Pathogenesis and Immunity

CMV is a lytic virus, which produces the CPE *in vitro* and *in vivo*. The pathogenesis of CMV infection is similar to that of other herpesviruses in many ways.

### ► Pathogenesis of CMV infection

The virus infects the epithelial cells of the salivary glands, causing a persistent infection and shedding of viruses in the salivary secretion. Activation and multiplication of the virus in the kidney and secretory glands facilitate secretion of CMV in urine and other body secretions including serum and milk.

CMV infection is acquired by coming in contact with blood, tissue, and most body secretions containing viruses. On entering the human host, CMV primarily affects epithelial cells and causes infection of those cells. Subsequently, CMV infection progresses to establish persistent and latent infection in T cells, macrophages, and other cells and in different organs, such as the kidney and heart.

In the infected cells, CMV infection produces characteristic enlarged cells with viral inclusion bodies. This histopathological change, most commonly referred to as *owl's eye*, is considered diagnostic of the CMV infections. These histological findings, however, may be minimal or absent in infected organs.

### ► Host immunity

Immunity to CMV involves both humoral immunity and CMI. CMI is more important and essential (*a*) for resolution of infection and (*b*) also for controlling progression of CMV infection. The production of cytotoxic T cells against CMV is very crucial in CMI response to control the infection.

CMV-specific CD4 and CD8 lymphocytes play an important role in protection after primary infection or reactivation of latent disease. Studies have shown that patients who do not develop CMV-specific CD4 or CD8 cells are at higher risk for developing CMV pneumonitis. Suppression of CMI, which is caused by therapy with corticosteroid or infection with HIV, induces reactivation of the latent viral infection. Recent

studies have also shown that many viral gene products appear to modulate host inflammatory response and are responsible for symptoms of the disease.

The humoral immunity is characterized by development of CMV IgM antibodies during 4–7 weeks of infection. These neutralizing antibodies are directed mostly against an envelope glycoprotein gB. More than 50% of neutralizing antibodies in convalescent serum are found to be produced against glycoprotein gB. Antibodies are also produced against other viral proteins, such as pp153, pp28, and pp65. The antibodies have some role in control of severe disease, but do not prevent transplacental infection, which can occur even in pregnant mothers who are CMV seropositive.

## Clinical Syndromes

CMV causes (a) congenital CMV infection, (b) acquired CMV infection, (c) CMV infection in immunocompromised patients, and (d) CMV infection in immunocompetent adult hosts.

### ► Congenital CMV infection

CMV is the most common viral cause of congenital infection. The infection is acquired by fetus by transmission of virus through placenta from mother's blood. The infection can also be an ascending infection from the cervix of the mother during recurrence of infection. The congenital infection may be classified as asymptomatic or symptomatic.

Asymptomatic congenital CMV infection occurs in infants born to women who have preexisting immunity to CMV. These infants appear normal at birth but are at risk of developing growth retardation and other neurodevelopmental abnormalities during later stage of life.

Cytomegalic inclusion disease is the manifestation of the symptomatic congenital CMV infection, which usually occurs in women who acquire primary CMV infection during pregnancy. The disease is characterized by microcephaly, intracerebral calcification, hepatosplenomegaly, and rash. Mental retardation and unilateral or bilateral hearing loss are the most common consequences of cytomegalic inclusion disease in adults. Approximately, 10% of affected infants show clinical evidence of disease at birth.

### ► Acquired CMV infection

Acquired CMV infection occurs postnatally as follows:

**Perinatal CMV infection:** This condition usually occurs following exposure to infected genital secretions in the birth canal or to milk during breast feeding. Most perinatal infections are asymptomatic. Some infants may manifest lymphadenopathy, hepatitis, and pneumonitis. However, these patients do not show any neurological or neurodevelopmental complications.

**CMV mononucleosis:** CMV mononucleosis is a disease of young adults acquired by person-to-person transmission. This condition is transmitted by blood transfusion or organ transplantation. Fever and severe malaise are typical symptoms.

Clinically, it is difficult to distinguish CMV mononucleosis from EBV-induced mononucleosis.

**Transfusion-acquired CMV infection:** This condition occurs following transfusion of infected blood after an incubation period of 20–60 days. This condition is mostly asymptomatic. In symptomatic cases, clinical manifestations of transfusion-acquired CMV are similar to CMV mononucleosis.

### ► CMV infection in immunocompromised host

CMV is the most important opportunistic agent in immunocompromised hosts, in whom it causes a variety of clinical syndromes. These include life-threatening intestinal pneumonitis, gastrointestinal diseases, retinitis, hepatitis, encephalitis, and varieties of other CMV syndromes. Patients receiving organ transplants are severely affected by the disease.

### ► CMV infection in immunocompetent adult hosts

CMV produces mononucleosis syndrome, a condition similar to EBV-induced mononucleosis in immunocompetent adult hosts. CMV is a sexually transmitted disease. The infection is transmitted by contaminated genital secretions.

## Epidemiology

CMV infection is worldwide.

### ► Geographical distribution

Many serological surveys have shown CMV to be present in 42–100% of the people depending on socioeconomic condition. In developing countries, infection of children is most common with a seroprevalence for CMV to be 100% very early in childhood. In developed countries, infection of the young adults is more common; more than 50% of young adults are seropositive in many developed countries.

### ► Reservoir, source, and transmission of infection

Humans are the natural hosts. An infected human is the only reservoir of CMV infection. No animal reservoirs are present for this virus. Cytomegaloviruses are found in the urine, blood, saliva, tears, throat swab, stool, semen, milk, amniotic fluid, cervical and vaginal secretions, and tissue obtained for transplantation.

Saliva, tears, urine, and breast milk are the common sources of infection for baby or child. Cervical secretions are the source of transmission of infection to neonates. Blood, organ graft, and semen are the other sources of infection in adult population. Transmission of CMV occurs in a variety of ways:

- Early in life, infection is transmitted to infants through the placenta, through infected birth canal, and also through breast milk.
- Infection to young children is most commonly transmitted by saliva.

- In adults, infection is transmitted sexually through semen and cervical secretions.
- Infection is also transmitted through the blood transfusion and organ transplantation.

CMV causes latent infection; hence reactivation may result in disease in patients who are immunocompromised. These patients include those with HIV and those receiving organ and bone marrow transplantation. Immunodeficiency caused by antineoplastic compounds and ionizing radiation may also cause reactivation of CMV infection.

## Laboratory Diagnosis

### ► Specimens

Different body secretions, such as saliva, urine, throat washing, blood, CSF, cervical secretions, and bronchoalveolar lavage fluid, and tissue bits are the specimens that can be used for the culture.

### ► Direct antigen detection

Direct immunofluorescence test using specific fluorescein-labeled monoclonal antibodies has been used to detect CMV pp65 and pp67 proteins of the virus directly in the clinical specimens, such as blood leukocytes. These proteins are typically expressed only during replication of the virus in the tissues.

### Key Points

- Antigen detection tests are very useful for detection of sub-clinical disease in immunocompromised patients at high risk.
- These are also useful to initiate specific antibiotic therapy in transplantation.

### ► Isolation of the virus

Cell culture is the definitive method for establishing diagnosis of CMV infection. Body fluids or organ tissues are usually cultured on human diploid fibroblast cell lines and are incubated for development of the characteristic CPEs for at least 4–6 weeks.

**Shell vial assay:** Though cell culture is highly sensitive, but takes a longer time of 4–6 weeks for identification of virus. To avoid that, shell vial assay is carried out for rapid detection of viruses. This is an adaptation of tissue culture, which provides result more rapidly. In this method, the clinical specimen is added to a vial containing a monolayer of cell line. The shell vial is centrifuged at a low speed and incubated for 24–48 hours. The tissue culture medium is removed, and the cells are stained using fluorescent-labeled anti-CMV antibodies and examined by a fluorescent microscope. The positive shell vial assay is the presumptive evidence of active CMV infection and has been found to be as sensitive as traditional tissue culture.

### ► Serodiagnosis

ELISA is a frequently used test to detect CMV IgM antibodies developed early during the course of illness and during reactivation of latent CMV infection. A fourfold or greater rise in antibody titer is diagnostic. The serology is useful for primary CMV infection, but not reliable for diagnosis of congenital CMV infection.



### Molecular Diagnosis

PCR has been developed to detect CMV DNA in tissue or body fluids, such as spinal fluid and amniotic fluid. The test is highly sensitive and becomes positive even before the viremia in those who are receiving organ transplants.

### ► Other tests

**Histology:** The presence of an enlarged cell that contains a dense, central *owl's eye* and basophilic intranuclear inclusion body is the characteristic feature of the cell infected by CMV. These cells are found in most tissues of the body and in the urine. These inclusion bodies can be readily seen on staining with hematoxylin–eosin or Papanicolaou's staining. These cells are found in most tissues of the body and in the urine.

## Treatment

Ganciclovir is the drug of choice for treatment of CMV. It is a nucleoside analog that inhibits DNA synthesis and also has activity against HSV, VZV, and human herpesviruses 7 and 8. Ganciclovir treatment is useful for gastrointestinal disease in patients who have received organ transplants and also those who are HIV positive. Ganciclovir has also been used as a prophylactic treatment of CMV disease in patients who have received transplants. This is given to all patients who have positive finding on serology and also to those who show evidence of ongoing replication. Neutropenia and thrombocytopenia are the major adverse effects associated with ganciclovir therapy. In addition, foscarnet is another drug, which has been used to treat the infection that is resistant to ganciclovir.

## Prevention and Control

Sexual transmission of CMV can be prevented by following safe sexual practices, such as using condoms. Transmission of virus is also reduced by regular screening of blood and organ donors for CMV seronegativity. Prophylaxis with ganciclovir prevents reactivation of latent CMV infection in immunocompromised patients. No vaccine is available for CMV.

## Human Herpesvirus 6

Human herpesvirus 6 (HSV-6) was first isolated from the peripheral blood of patient with AIDS in the year 1986. HSV-6 like EBV and CMV is lymphotropic and ubiquitous. This virus

is believed to persist chronically in salivary gland tissue in some of the adults. The virus is spread by the saliva, which is the main source of infection. Like other herpesviruses, HSV-6 causes a latent infection in T cells and monocytes. The replication of the virus in CD4+ T lymphocytes is controlled by CMI. The reactivation of the virus occurs in immunocompromised patients (patients with AIDS or other immunosuppression disorders). HSV-6 causes roseola infantum, a febrile infection that affects young children. The virus may also cause mononucleosis syndrome and lymphadenopathy.

### Human Herpesvirus 7

Human herpesvirus 7 (HSV-7) was first isolated from peripheral CD4 cells of healthy persons in 1990. HSV-7 like HSV-6 has also been isolated from saliva of healthy adults and has been implicated as one of the causative agents of rubeola

infantum and febrile seizures in children. The virus has also been associated with acute hemiplegia of childhood, hepatitis, and respiratory tract infections.

### Human Herpesvirus 8

Human herpesvirus 8 (HSV-8) is associated with Kaposi's sarcoma and also with body cavity lymphoma and Castleman disease. DNA sequences of HSV-8 have been identified in patients with Kaposi's sarcoma. This virus, also known as KS-associated herpesvirus, is believed to be important in causing and/or maintaining lesions in Kaposi's sarcoma. The lesion in Kaposi's sarcoma begins as red purple or dusky area that enlarges into a plaque and progresses subsequently into a tumorous growth. T-is condition is observed most commonly in immunosuppressed patients but also occurs in children, although rarely.



#### CASE STUDY

A 21-year-old college student attended medicine OPD with history of sore throat, low-grade fever for several days, followed by swollen cervical lymph nodes and increasing fatigue. Blood film examination revealed lymphocytosis with atypical cells. The serum for heterophile antibodies was positive by Paul-Bunnell test.

- Name the most likely diagnosis of the condition.
- What are the other laboratory tests that can be performed to diagnose the condition?
- Describe the methods of transmission of the condition.
- Describe the preventive measures for the condition.



# Adenoviruses

## Introduction

Adenoviruses cause a variety of sporadic and epidemic diseases in humans including acute respiratory disease, pharyngoconjunctival fever, epidemic keratoconjunctivitis, acute hemorrhagic cystitis, and more recently adenoviral infections in immunocompromised hosts. Of most recent interest is the role of adenoviruses as vectors in gene therapy. The virus is being used to deliver DNA for gene replacement therapy in few genetic disorders, such as cystic fibrosis.

## Adenovirus

### Classification

Adenoviruses belong to the family Adenoviridae, which consist of a group of medium-sized, nonenveloped, double-stranded DNA viruses that multiply in the nucleus of the infected cell. The family consists of two distinct genera: *Mastadenovirus* and *Aviadenovirus* consisting of mammalian and avian adenoviruses, respectively. The genus *Mastadenovirus* comprises at least 49 serotypes, which infect humans. All these human serotypes have been divided into six groups (A–F) on the basis of their DNA homology and other physical, chemical, and biologic properties (Table 58-1).

### Properties of the Virus

#### ► Morphology

Adenoviruses show following features:

- Adenoviruses are double-stranded DNA, nonenveloped viruses measuring 80–110 nm in diameter.

- The adenovirus genome is a linear double-stranded DNA with terminal protein. DNA contains terminal incorporated lipids of more than 100 base pairs, rendering the single-stranded DNA to form pan-handle-shaped molecules. The viruses have icosahedral nucleocapsid with a diameter of 70–90 nm.
- Adenoviruses have a characteristic morphology. They are the only viruses having a fiber protruding from each of the 12 vertices of the capsid.
- The capsid is composed of 252 capsomeres, which consist of hexons and pentons. Of these 252 capsomeres, 240 hexons make up the 20 triangular faces of icosahedron and 12 pentons form the bases.
- An apical fiber, 9–31 nm in length and 62 kDa in molecular mass, projects from each penton. This apical fiber helps to bind specifically adenoviruses to receptor sites on the host cells. The fiber contains the viral attachment proteins and can act as a hemagglutinin. The penton base and fiber are toxic to cells. The type-specific antigens are present in the pentons and also in the fibers.
- Viruses encode proteins to promote messenger RNA (mRNA) and DNA synthesis including its own DNA polymerase.

#### ► Viral replication

Adenoviruses attach to surface of the cells by their fibers, then penetrate the cell, and once inside the cell, uncoat the viral DNA. The viral DNA is then transported into the nucleus of the cell and initiates replication cycle. Host cell DNA-dependent RNA polymerase transcribes the early genes leading to formation of functional mRNA. Then in the cytoplasm, the early mRNA is translated into nonstructural proteins. In the nucleus, after viral DNA replication, late mRNA is transcribed and then translated into structural virion proteins. This is followed by assembly of virions in the nucleus and release of virions by lysis of the cells, but not by budding.

TABLE 58-1

Classification of human adenoviruses

Groups	Serotypes	Hemagglutination with red cells	Oncogenicity in hamsters	Transformation of cells
A	12, 18, 31	Rat (partial)	High	+
B	3, 7, 11, 14, 16, 21, 34, 35	Monkey (complete)	Weak	+
C	1, 2, 5, 6	Rat (partial)	None or low	+
D	8–10, 13, 15, 17, 19, 20, 22–30, 32, 33, 36–39, 42–47	Rat (complete)	None but can transform cells	+
E	4	Rat (partial)	None or low	+
F	40, 41	Rat (partial)	None	+

### ▶ Antigenic and genomic properties

Viral group-specific antigen is present on the inner surface of hexon capsomere. These group antigens can be detected by immunofluorescence or enzyme-linked immunosorbent assay (ELISA). Type-specific antigen is located on other region of the hexon and on the fiber. The fiber protein is the main type-specific antigen. Fiber determinant ( $\gamma$ ) is a type-specific hemagglutinin. Serotypes are identified by neutralization test.

#### Key Points

Human adenoviruses are classified into six groups (A–F), also called subgroups or subgenera based on the properties, such as (i) DNA fragment analysis, (ii) fiber length hemagglutination, and (iii) oncogenic potential. These subgroups are further classified into 49 different serotypes based on the differences in their penton bases and fiber proteins, which determine the nature of tissue tropism and disease.

### ▶ Other properties

Adenoviruses are relatively stable and remain viable for about a week at 37°C but are readily inactivated at 50°C. They are resistant to ether and bile salts. They resist drying, detergents, gastrointestinal tract secretions including acid, protease, and bile, and even mild chlorine treatment.

### Virus Isolation and Animal Susceptibility

Human adenoviruses are highly host specific; hence laboratory animals are not susceptible to infection by the virus.

### ▶ Cell culture

Human adenoviruses can be grown only in tissue cultures of human origin. They grow well on monolayer of HeLa, Hep-2, KB, and human embryo kidney cells. Cytopathic changes are observed after 1–4 weeks of inoculation and consist of cell rounding and aggregation into grape-like clusters. Infected cells swell, become ballooned, and show intranuclear inclusions in stained preparations.

### Pathogenesis and Immunity

Tissue tropism of the specific groups or serotypes of adenovirus strain determine the type of disease caused by adenoviruses in humans.

### ▶ Pathogenesis of adenovirus infections

Adenoviruses are transmitted mainly by respiratory or feco-oral contact between humans. They infect the conjunctiva or the nasal mucosa. They may multiply in conjunctiva, pharynx, or small intestine, and then spread to preauricular, cervical, and mesenteric lymph nodes, where epithelial cells are infected. Adenoviruses may cause three different types of interaction with the infected cells. These are (a) lytic infection, (b) latent infection, and (c) transforming infection.

**Lytic phase:** Adenoviruses infect mucoepithelial cells in the respiratory tract, gastrointestinal tract, and conjunctiva or cornea, causing damage of these cells directly. After local replication of the virus, viremia follows with subsequent spread to visceral organs. Dissemination occurs more commonly in immunocompromised patients than in the immunocompetent individuals.

**Latent infection:** The adenovirus has a unique ability to become latent in lymphoid and other tissues, such as adenoids, tonsils, and Peyer's patches. The exact mechanism of latency of adenoviruses in these tissues is not known. These latent infections can be reactivated in patients infected with other agents or in the patients who are immunocompromised.

**Oncogenic transformation:** Some adenoviruses belonging to groups A and B have the property for oncogenic transformation in rodent cells. During oncogenesis, the multiplication of adenovirus is inhibited followed by integration of viral DNA into the host DNA. After integration, adenoviruses produce EIA proteins, which target rodent cells by altering cellular transcription, finally leading to transformation of rodent cells. However, oncogenesis of human cells has not been demonstrated.

### ▶ Host immunity

Adenovirus infection is characterized by development of an effective and long-lasting immunity against reinfection. Both cell-mediated immunity (CMI) and humoral immunity are important. CMI plays an important role in limiting proliferation and outgrowth of adenoviruses. Therefore, different disease is seen in persons whose CMI is immunocompromised. Serum antibodies play an important role for resolving adenovirus infection. Resistance to clinical disease is believed to be directly related to the presence of circulating neutralizing antibodies. The antibodies protect the person from reinfection with the same serotype but not other serotypes. Moreover, adenovirus infection confers lasting immunity to reinfection with the same serotype.

### Clinical Syndromes

Adenoviruses primarily infect children. Adults are also infected. Certain serotypes of adenovirus are associated with specific syndromes. Respiratory infections are caused by low-numbered serotypes (1, 2, 3, 5, and 7) and gastrointestinal infection by high-numbered serotypes (40, 41, 42) (Table 58-2). Incubation period varies from 5 to 8 days. Major clinical syndromes caused by the human adenoviruses are as follows:

### ▶ Respiratory diseases

**Acute respiratory disease:** This disease is caused by adenovirus serotypes 4 and 7. Fever, rhinorrhea, cough, and sore throat are the typical symptoms, which last for 3–5 days. This syndrome most often affects military recruits living in crowded conditions.

**Pharyngoconjunctival fever:** This syndrome occurs primarily in school-going children. Fever, sore throat, coryza, and red eye are the classic presentations of the condition. These symptoms

TABLE 58-2

**Diseases associated with various serotypes of adenoviruses**

Disease	Serotypes
Acute respiratory disease	4, 7, 14, 21
Acute febrile pharyngitis	
Endemic	1, 2, 5, 6
Epidemic	3, 4, 7
Pneumonia	1–3, 7
Pharyngoconjunctival fever	3, 4, 7
Acute follicular conjunctivitis	3, 4, 11
Epidemic keratoconjunctivitis	19, 37
Gastroenteritis and diarrhea	40, 41
Intussusception	1, 2, 5
Acute hemorrhagic cystitis	11, 21
Disseminated infection	5, 34, 35, 43–47

may precede ocular findings, or they may not be present. Acute conjunctivitis may occur as a separate entity with or without pharyngitis. The condition is usually self-limiting. This condition is caused predominantly by serotypes 3, 4, and 7.

**Other respiratory tract diseases:** Bronchiolitis, croup, laryngitis, and cold-like symptoms are the other respiratory tract diseases caused by adenoviruses.

### ► Epidemic keratoconjunctivitis

This is a highly contagious condition and has an insidious onset of unilateral red eye. Subsequently, both the eyes are involved. Patients complain of photophobia, tearing, and pain. Fever and lymphadenopathy may be present in some children. Inflammation of the conjunctiva may persist for a week, accompanied with residual scarring and visual impairment. The condition may occur as an epidemic, which is usually caused by serotype 8 and less often by serotypes 19 and 37.

### ► Gastroenteritis and diarrhea

These conditions are most commonly associated with serotypes 40 and 41, but other serotypes may also be involved. The enteric adenovirus infection is a common cause of infantile diarrhea in day-care centers. The condition manifests as fever and watery diarrhea, which resolves within 1–2 weeks.

### ► Other manifestations

Adenoviruses have also been associated with acute hemorrhagic cystitis caused by serotypes 11 and 21, intussusception in young children, pertussis-like illness, musculoskeletal disorders, and genital and skin infections.

### ► Adenovirus infections in immunocompromised host

These infections are caused by multiple serotypes of adenoviruses. These serotypes cause disease during the posttransplant period in the patients who have received hematopoietic

stem cell transplant. Patients receiving stem cell transplantation and with T-cell deletion and lymphopenia are at risk for serious adenovirus infections. Infections in these patients may cause variable manifestations, but include hemorrhagic cystitis, pneumonia, nephritis, and gastroenteritis. Infection occurs either by reactivation of old infection or by exogenous transmission from other infected hosts. Adenovirus serotypes associated with various human illnesses are summarized in Table 58-2.

## Epidemiology

Adenovirus infections are found worldwide.

### ► Geographical distribution

More than one serotypes of virus may produce the same clinical syndrome, and one serotype of virus may cause clinically different diseases. Adenoviruses 1–7 are the common serotypes worldwide and are responsible for most cases of adenovirus-associated infections.

### ► Reservoir, source, and transmission of infection

Adenovirus infections are exclusively human infections. No animal reservoirs are present. Infected symptomatic as well as asymptomatic humans who excrete adenoviruses intermittently in their respiratory secretions and also in their stool are the sources of infection. The infection is transmitted from person-to-person directly by

- aerosol droplets,
- feco-oral route,
- direct inoculation of conjunctiva by contaminated fingers,
- contaminated fomites including towels and medical instruments, and
- swimming in improperly disinfected swimming pool.

Overcrowding, poor hygiene, and close contact facilitate transmission of infection. Adenovirus typically affects children, starting from infants to school-going ones, though children of any age may be affected.

## Laboratory Diagnosis

### ► Specimens

Specimens used depend on the nature of the clinical illness caused by adenoviruses. These include throat swab, nasopharyngeal aspirate, bronchial lavage, conjunctival swab, corneal scraping, urine, and feces.

### ► Microscopy

Certain serotypes of enteric adenoviruses may be seen directly in stool specimens by electron microscope. These serotypes (40, 41, 42) are difficult to grow in cell cultures, hence are referred to as noncultivable adenoviruses.

### ► Direct antigen detection

ELISA or direct fluorescent antibody test using specific antibodies raised against adenoviruses is used to detect viral antigen in feces and nasopharyngeal secretions.

### ► Isolation of the virus

Isolation of the virus by cell culture establishes the specific diagnosis of the condition. Viruses from clinical specimens may be isolated on primary human embryonic kidney cells, HeLa, Hep-2, and KB cells. The viruses within 2–20 days produce a lytic infection with characteristic inclusion bodies. Primary human embryonic kidney cells support growth of many fastidious adenoviruses. The viral antigens in the cell culture can be detected by direct immunofluorescent test using polyclonal or monoclonal antibodies. The viral isolates are usually classified into subgroups by hemagglutination with rat and monkey erythrocytes. Further serotyping is carried out by neutralization test.

### ► Serodiagnosis

Serology is rarely used for diagnosis of the cases. It is usually used for epidemiological studies. They are also used to confirm causative role of a fecal or respiratory tract isolate by identifying its serotype.



### Molecular Diagnosis

DNA probe and polymerase chain reaction (PCR) are used to identify enteric adenovirus serotypes 40, 41, and 42 directly in stool specimens, which do not grow in cell cultures. These methods are also used to detect, type, and group adenovirus isolates in tissue culture and stool specimens.

## Treatment

At present, no specific antiviral agents are available for treatment of adenovirus infections. Ribavirin has been used with variable success in treatment of adenovirus infections in immunosuppressed hosts.

### Vaccines

Three live, nonattenuated vaccines against serotypes 4, 7, and 21 are available for use as oral vaccines. Each of the three vaccines is monovalent, and each vaccine contains only one serotype.

- These vaccines are given orally in a gelatin-coated capsule, which protects the live virus from inactivation by stomach acidity. The virus is released in the intestine, where it replicates and induces neutralizing antibodies. The vaccine strain does not spread from person to contacts.
- The vaccine is available for only military recruits in the United States and is not available for civilian use.

## Adeno-Associated Viruses

Adeno-associated viruses (AAVs) are small, icosahedral viral particles measuring 20–25 nm in diameter. They are so called because they can multiply only in cells simultaneously infected with adenovirus, but cannot multiply independently because they lack enough DNA. These viruses have been classified in the genus *Dependovirus*. Four serotypes (1–4) have been recognized, of which types 1, 2, and 3 are of human origin and type 4 is of simian origin. The pathogenic role of the human serotypes of AAVs is not clear.



### CASE STUDY

A 3-year-old child in a nursery school suffered from a mild respiratory tract infection. Subsequently, many other children studying in the same nursery also suffered from the same illness. A viral infection is suspected.

- Name the adenovirus types frequently associated with this illness.
- List other types of adenoviruses and the diseases caused by them.
- Describe the laboratory methods for diagnosis of the condition.
- Describe the vaccines available against the condition.

# Parvoviruses

## Introduction

Parvoviruses are the smallest of the DNA viruses belonging to the family Parvoviridae. They are icosahedral, nonenveloped viruses containing a single-stranded DNA. Human parvovirus B19 (B19) is the only known parvovirus that is pathogenic for humans, and it shows tropism for erythroid progenitor cells.

## Classification

The family Parvoviridae consists of three genera: *Dependovirus*, *Parvovirus*, and *Erythrovirus*. The genus *Dependovirus* consists of poxviruses, which are defective and replicate only in association with a second helper virus. They neither cause illness by themselves nor alter the infection caused by helper viruses. These are usually found in association with an adenovirus, hence are known as adeno-associated viruses. These viruses do not cause any disease in humans. The genus *Parvovirus* includes animal viruses of veterinary importance, such as feline panleukopenia virus and canine parvovirus. The genus *Erythrovirus* consists of B19, the only member of the Parvoviridae family known to cause disease in humans. The diseases associated with B19 are summarized in Table 59-1.

TABLE 59-1

Human infections caused by B19 virus

Disease	Manifestations
Flu-like illness	Malaise, headache, myalgia, and rhinorrhea
Erythema infectiosum	Cutaneous rash, arthralgia; aplastic crisis “Fifth disease” in children
Infection in pregnant women	Reinfection in a pregnant mother: no adverse effects; nonimmune seronegative pregnant mothers: hydrops fetalis and fetal death
Chronic B19 infection	Chronic anemia, leukopenia, and thrombocytopenia
Transient aplastic crisis	Severe acute anemia

## Parvovirus B19

Parvovirus B19, or B19 virus, is the causative agent of erythema infectiosum (“fifth disease”—it was fifth of the six classified exanthematous diseases of childhood), a mild viral illness of children, and polyarthralgia–arthritis syndrome in immunocompetent adults.

## Properties of the Virus

### ► Morphology

B19 viruses show the following properties:

- B19 viruses are extremely small viruses, measuring 18–26 nm in diameter.
- They possess a nonenveloped, icosahedral capsid.
- The viral genome contains a single-stranded DNA measuring 4000–6000 bases in length.
- The genome is negative-strand DNA, but there is no virion.
- The genome encodes for many proteins, which include three structural, one major nonstructural, and several smaller proteins.

### ► Viral replication

B19 virus shows tropism for (a) bone marrow cells, (b) erythroid cells from fetal liver, and (c) erythroid leukemia cells. Replication of virus occurs in the nucleus. The single-stranded DNA genome has hairpin loops at both of its ends, which facilitate double-stranded areas for the cellular DNA polymerase to start synthesis of the progeny genomes. The cellular RNA polymerase synthesizes viral mRNA from the double-stranded DNA intermediate. This is followed by assembly of virions in the nucleus. Viral replication results in cell death.

### ► Antigenic properties

Only one serotype of B19 virus is known to occur.

### ► Other properties

B19 virus is highly resistant to inactivation but can be inactivated by formalin, beta propiolactone, and oxidizing agents. The viruses withstand heating at 56°C for 30 minutes and are stable between pH 3 and 9.

## Pathogenesis and Immunity

B19 virus shows a tropism for two types of cells: (a) red blood cell (RBC) precursors and (b) endothelial cells in the blood vessels.

### ▶ Pathogenesis of parvovirus infections

The virus infects rapidly dividing erythrocyte precursors, such as bone marrow cells, erythroid cells from fetal liver, and erythroid leukemia cells, and destroys these cells after infection, thereby causing aplastic anemia. Infection of the endothelial cells in the blood vessels leads to erythema infectiosum. It has been demonstrated that the B19 virus first enters through the nasopharynx or upper respiratory tract and then spreads to the blood, causing viremia. The virus then infects mitotically active erythroid precursor cells in bone marrow and establishes the infection.

The virus enters susceptible cells through the P blood antigen receptors on the erythrocyte precursors. Inside the red cells, the virus enters the nucleus, starts replicating, followed by killing of the red cells. The production of RBCs is stopped for approximately 1 week due to killing of the erythroid precursor cells by the viruses. The initial stage is associated with flu-like illness caused by large viremia. The viruses are shed in the oral and respiratory secretions and even cross the placenta. Subsequently, viremia is controlled by the production of specific antibodies against B19 virus.

The rash and arthralgia present the second stage of the disease and is believed to be immunologically mediated. This stage coincides with the disappearance of B19 virus from the circulation, appearance of B19 virus-specific IgM and IgG antibodies, and finally the formation of immune complexes.

### ▶ Host immunity

The disease exhibits two stages: initial stage is flu-like illness and second stage is appearance of rash and arthralgia. Host immunity to B19 virus infection is primarily antibody mediated. The circulating antibodies stop the viremia and are important for resolution of the disease. The role of cell-mediated immunity in conferring immunity to B19 virus is unknown.

## Clinical Syndromes

B19 virus causes following clinical syndromes: (a) flu-like illness, (b) erythema infectiosum or fifth disease, (c) infection in pregnant women, and (d) chronic B19 infection.

### ▶ Flu-like illness

B19 virus most commonly causes a flu-like illness. Malaise, headache, myalgia, and rhinorrhea are the common symptoms.

### ▶ Erythema infectiosum or fifth disease

B19 virus is an additional causative agent of erythema infectiosum or fifth disease, the condition seen most commonly in children. The infection begins with nonspecific symptoms,

followed by appearance of a distinctive rash on fifth day of infection. A bright red rash develops on both cheeks that appear as they have been slapped. The rash then appears on the trunk, which spreads gradually toward the arms and legs. The condition usually subsides within 1–2 weeks.

**Aplastic anemia:** Transient but severe aplastic anemia can occur in children with chronic anemia, such as sickle cell anemia, thalassemia, and spherocytosis (aplastic crisis) after infection with B19 virus. Gloves and sock syndrome is another serious complication caused by B19 virus. In this syndrome, erythematous exanthema appears on the hands and feet, with a well-defined margin on the wrist and ankle joints.

### ▶ Infection in pregnant women

If the B19 virus causes reinfection in a pregnant mother who is infected earlier by the same virus and is already immune to the virus (showing positive B19 antibodies), then no adverse effects are seen in the fetus. In nonimmune seronegative pregnant mothers, B19 virus infection is increasingly associated with risk for fetal death. The infection may cause severe anemia in the fetus and subsequently, the fetus may develop signs of high-output cardiac failure (*hydrops fetalis*). B19 virus, however, does not cause any congenital anomalies in the fetus.

### ▶ Chronic B19 infection

This infection occurs in immunocompromised patients, such as patients with HIV, those receiving immunosuppressive therapy, and transplant patients. Chronic anemia, leukopenia, and thrombocytopenia are the common manifestations.

## Epidemiology

### ▶ Geographical distribution

B19 virus is distributed worldwide. The exact data on seropositivity in population world over is not known. Approximately, 90% of adults older than 60 years are seropositive in the United States. Similar data from other parts of the world are lacking.

### ▶ Reservoir, source, and transmission of infection

B19 virus infection is strictly a human disease. Humans are the only reservoir. Viruses are excreted in respiratory samples, which are the primary source of infection. The infected patient is contagious from 24 to 48 hours before developing prodromal syndrome till the appearance of rash. The infection is transmitted by:

- vertical transmission during birth;
- respiratory route through respiratory secretions; and
- percutaneous exposure to blood and transfusion of blood and blood products (pooled RBCs, platelets, intravenous immunoglobulins, etc.).

## Laboratory Diagnosis

Demonstration of specific IgG and IgM antibodies in the serum is useful for diagnosis of erythema infectiosum caused

by B19 virus. ELISA (enzyme-linked immunosorbent assay), RIA (radioimmunoassay), and IFA (indirect fluorescent antibody) for demonstration of IgG and IgM antibodies are available. In pregnant women, the serum positive for IgG and IgM antibodies indicates B19 virus infection within 7 days to 4 months and a possible risk to fetus. Positive IgG but negative IgM result indicates only past infection, hence no risk to fetus. Furthermore, polymerase chain reaction (PCR) is available to demonstrate B19 virus genome in the blood. The positive result suggests viremia or infection.

## Treatment

No specific antiviral therapy is available for treatment of B19 virus infection.

## Prevention and Control

No specific measures are available for prevention of the infection. Development of a vaccine against B19 virus is undergoing phase I clinical trial.



### CASE STUDY

A 31-year-old man with HIV was admitted to a hospital with aplastic anemia. The serum was positive for B19 viral genome by PCR.

- What is the most likely route of transmission?
- What are the clinical manifestations of B19 virus infection in children and in pregnant women?
- Describe the laboratory methods for diagnosis of B19 virus infection.

# Picornaviruses

## Introduction

The family Picornaviridae is one of the largest families of viruses and includes a large number of very small (*pico*: measuring small; *rna*: RNA virus) RNA viruses. They are nonenveloped viruses measuring 27–30 nm in size. The capsid is a naked icosahedral made up of 60 protein subunits. The genome consists of a single linear molecule of single-stranded RNA. The genome RNA is unusual, because it has a protein at the 5' end that serves as a primer for transcription by RNA polymerase.

## Classification

The family Picornaviridae consists of more than 230 members and is divided into five genera: *Enterovirus*, *Rhinovirus*, *Hepatovirus*, *Arthrovirus*, and *Cardiovirus*. The first three genera (*Enterovirus*, *Rhinovirus*, and *Hepatovirus*) are the important viruses, which cause disease in humans. Two other genera (*Arthrovirus* and *Cardiovirus*) are of veterinary importance and cause foot-and-mouth disease in cattle and meningoencephalomyelitis in mice. The picornaviruses causing human infections are summarized in Table 60-1. The important features of picornaviruses are summarized in Table 60-2.

## Enteroviruses

Human enteroviruses consist of at least 72 serotypes, which include poliovirus types 1–3, coxsackieviruses A types 1–24, coxsackieviruses B types 1–6, echoviruses types 1–34, and enteroviruses 68–71. Originally hepatitis A virus (enterovirus 72) was included in this group but has been reclassified as a hepatovirus in the genus *Hepatovirus* (Chapter 66).

The capsids of the enteroviruses are very resistant to environmental conditions and the conditions in the gastrointestinal tracts. They can remain viable for several weeks in feces at room temperature. They also remain viable for a year at –20 to –70°C and for months at 4°C. The virus may survive heat at 60°C in food stuffs and also holder method of pasteurization. The enteroviruses are also rapidly inactivated by 0.3% formaldehyde, 0.1 M hydrochloric acid, drying, or ultraviolet light. The enteroviruses are readily killed by moist heat at 50–55°C, and they are also inactivated on exposure to ether, chloroform, and deoxycholate. A higher concentration of chlorine is necessary in water to inactivate the virus in the

presence of organic matter, because the latter diminishes the activities of residual chlorine.

Most enteroviruses are host specific; they infect only one or a few related species.

## Poliovirus

Poliomyelitis is an enteric infection caused by polioviruses transmitted by the fecal–oral route. The worldwide prevalence of poliomyelitis has decreased by more than 99% due to improved socioeconomic conditions and availability of vaccines.

## Properties of the Virus

### ► Morphology

Polioviruses show the following features:

- Poliovirus was the first animal virus to be purified and obtained in crystalline form.
- The viruses are spherical particles about 27 nm in diameter (Fig. 60-1).
- The virion is composed of 60 subunits, each consisting of four viral proteins (VP1–VP4).
- The viral protein VP1 contains the major antigenic site for combination with type-specific neutralizing antibodies.
- The viral genome is a single-stranded positive-sense RNA, which can be directly translated by host ribosomes to form a polyprotein, which is divided into 11 different proteins.

### ► Viral replication

Polioviruses are cytolitic; they replicate in cytoplasm of the host cell. Polioviruses show high host specificity restricted to primates, which include both humans and nonhuman primates, such as monkeys and apes. This is due to presence of a specific receptor that is present only on primate cell membrane. However, purified viral RNA without the capsid protein can enter and replicate in many nonprimate cells by avoiding the cell membrane receptors.

The virion causes infection first by binding to the specific receptor on the cell membrane and enters the cell. Once inside the cell, the virion uncoats by removing the capsid and releases the RNA genome. The RNA serves as the mRNA and is translated into a very large polypeptide known as noncapsid



**TABLE 60-1 Human infections caused by picornaviruses**

Virus	Serotype	Clinical syndrome
Poliovirus	1-3	Aseptic meningitis, paralysis, and undifferentiated febrile illness
Coxsackievirus group A	1-24	Aseptic meningitis and exanthemas
	7, 9	Paralysis
	2, 5-7, 9	Encephalitis
	2-6, 8, 10	Herpangina
	5, 10, 16	Hand-foot-and-mouth disease
	4, 9	Hepatitis
	9, 16	Pneumonitis of infants
	18, 20-22, 24	Diarrhea
	21, 24	Cold
	24	Acute hemorrhagic conjunctivitis
Coxsackievirus group B	1-6	Aseptic meningitis, febrile illness
	2-5	Paralysis
	1-5	Encephalitis, pleurodynia, myocarditis, generalized disease of infants, pericarditis
	5	Exanthemas and hepatitis
	1, 3-5	Cold
	4, 5	Pneumonia
	3, 4	Diabetes mellitus
Echovirus	1-34	Aseptic meningitis and diarrhea
	2, 4, 6, 9, 11, 30	Paralysis
	2, 6, 9, 19	Encephalitis
	2, 4, 6, 9, 11, 16, 18	Exanthemas
	1, 6, 9	Pleurodynia
	1, 6, 9, 19	Myocarditis and pericarditis
	4, 9, 11, 20, 25	Cold
	4, 9	Hepatitis
	11	Generalized disease of infants
Enterovirus	68	Pneumonia
	70	Acute hemorrhagic conjunctivitis
	71	Pulmonary edema, herpangina, aseptic meningitis, and hand-foot-and-mouth disease
	70, 71	Paralysis and encephalitis
Rhinoviruses	> 100	Common cold

**TABLE 60-2 Classification and important properties of picornaviruses of medical importance**

Virus	Antigenic types	Serotypes	Stability at acid pH	Optimal temperature for growth (°C)	Sites of isolation		
					Nose	Throat	Intestine
Poliovirus	1-3	3	Stable	37	-	+	+
Coxsackie A virus	1-22, 24	23	Stable	37	-	+	+
Coxsackie B virus	1-6	6	Stable	37	-	+	+
Echovirus	1-9, 11-27, 29-34	30	Stable	37	-	+	+
Enterovirus	68-71	4	Stable	37	-	+	+
Rhinovirus	1-113	113	Labile	37	+	+	-

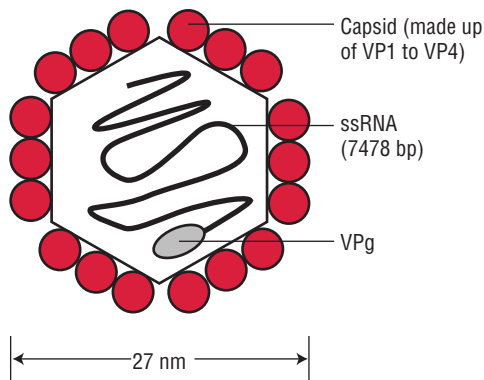

FIG. 60-1. Schematic diagram of structure of a poliovirus.

viral protein. Subsequently, the viral protein is utilized by the viral enzyme protease to form capsid proteins of the progeny virions as well as several noncapsid proteins including the RNA polymerase.

RNA polymerase initiates the synthesis of progeny RNA genomes. This is followed by assembly of the progeny virions by coating of the genome RNA with capsid proteins in the cell cytoplasm. The release of progeny virions occurs by the lysis and death of the cells, but not by budding from the cell membrane.

### ▶ Antigenic properties

The polioviruses have been classified into three serotypes (types 1, 2, and 3) on the basis of neutralization test. The prototype strains for type 1 poliovirus are Brunhilde and Mahoney strains, for type 2 poliovirus are Lansing and MEFI strains, and for type 3 poliovirus are Leon and Saukett strains. Type 1 is the most common poliovirus and causes most epidemics of poliomyelitis; type 2 strain is usually associated with endemic infections, whereas type 3 strains occasionally cause epidemics. Two antigens, C (coreless or capsid) and D (dense) are recognized by enzyme-linked immunosorbent assay or precipitation test. The C antigen, also known as heated or H antigen is associated with the empty, noninfectious virus. It is less specific and reacts with heterotypic sera. The D antigen, also known as the nature or N antigen is associated with the whole virion. It is more specific and is type specific. Antibodies against D antigen are protective; hence the potency of injectable polio vaccine is measured in terms of D antigen unit.

### ▶ Other properties

Poliovirus is sensitive to heat and is readily inactivated at 55°C for 30 minutes. It is also sensitive to formaldehyde and oxidizing disinfectants. The viruses are readily destroyed by chlorination in water, but the presence of organic matter delays inactivation.

Polioviruses are resistant to lipid-soluble agents (ether, chloroform, and bile), proteolytic enzymes of the intestine, and detergents. They survive in feces for months at 4°C and for

years at -20°C. They survive for days to several weeks in feces at room temperature depending on the environmental conditions, such as temperature, moisture, acidity, etc. Polioviruses are killed by lyophilization.

## Virus Isolation and Animal Susceptibility

### ▶ Cell culture

Polioviruses grow readily in cell lines of primate origin. They can be cultured on monkey kidney cell lines, human amnion, HeLa, Hep-2, MRC-5, and other cell lines. The cytopathic effects consist of cell retraction, increased refractivity, cytoplasmic granularity, and nuclear pyknosis and are observed within 48 hours of inoculation. Eosinophilic intranuclear inclusion bodies may be demonstrated in stained preparation of the infected cell lines. Well-formed plaques develop in infected monolayers with agar overlay.

### ▶ Laboratory animals

Cynomolgus and rhesus monkeys are commonly used animals. They can be experimentally infected by intracerebral or intraspinal inoculation. Cynomolgus monkeys and chimpanzees can also be infected orally. Laboratory-maintained strains may grow in rodents and chick embryos. But fresh isolates of poliovirus cannot grow in these hosts.

## Pathogenesis and Immunity

Poliovirus is transmitted by the fecal oral route on ingestion of contaminated water. The viral particles initially multiply in the nasopharynx and the gastrointestinal mucosa. The virions are resistant to acidity of stomach and to lytic activities of the protease and other enzymes of the intestinal tract and bile.

### ▶ Pathogenesis of poliomyelitis

On entering the body, the virus infects and multiplies in the tonsils and Peyer's patch of the ileum. It then spreads to regional lymph nodes and enters the blood, causing a primary viremia. On continued infection and multiplication of virus in the reticuloendothelial cells, it invades the blood stream again and causes secondary viremia. During this period of viremia, the poliovirus crosses the blood-brain barrier or gains access to the brain by infecting skeletal muscle and traveling up on the nerves to the brain as in rabies virus.

Poliovirus shows tissue tropism by specifically combining with neural cells. It recognizes a receptor present on the anterior horn cells of (a) the spinal cord, (b) dorsal root ganglia, and (c) motor neurons. On combination at these sites, the poliovirus causes destruction of the motor neurons, anterior horn, and brain stem. The destruction of motor neurons leads to paralysis of the muscles innervated by those neurons. Paralysis is not caused by the virus infecting the muscles. The poliovirus also infects the brain stem,

causing bulbar poliomyelitis associated with respiratory paralysis.

Poliovirus causing the pathological changes in the central nervous system (CNS) is usually responsible for causing symptoms of poliomyelitis. Immune mechanisms do not play any role in pathogenesis of the disease.

### ► Host immunity

Host immunity in poliomyelitis is mostly dependent on the humoral antibodies. Both the serum and secretory antibodies play an important role in conferring protection against poliomyelitis.

- **Serum IgM antibodies** appear within a week of infection and persist for nearly 6 months. IgG antibodies, which develop subsequently, persist lifelong. The neutralizing antibodies in the blood protect against disease by the same serotype of poliovirus. These antibodies, however, do not prevent infection of the intestinal neuron and excretion of virus in the feces.
- **Secretory IgA antibodies** provide mucosal immunity against the virus (*a*) by preventing intestinal infections and (*b*) by preventing shedding of virus. The IgA antibody in the breast milk protects the infants from infection. Therefore, the poliomyelitis tends to be more severe and shedding of virus is more prolonged in the infected human host with altered humoral immune response.

Cell-mediated immunity plays little or very insignificant role in the immunity against poliovirus. Host immunity is type specific. However, there is a significant amount of cross-protection between type 1 and 2 and type 2 and 3 polioviruses. There is little or no cross-protection between type 1 and 3 strains.

## Clinical Syndromes

Poliovirus causes a wide spectrum of illness in unvaccinated people, such as (*a*) asymptomatic illness, (*b*) abortive poliomyelitis, (*c*) nonparalytic poliomyelitis, (*d*) paralytic polio, and (*e*) postpoliomyelitis syndrome. Incubation period is usually 10 days but may vary from 4 days to 4 weeks.

### ► Asymptomatic illness

Most patients (90–95%) infected with poliovirus develop inapparent infection and are asymptomatic. This asymptomatic illness is caused as a result of viral infection confined to the oropharynx and the intestine.

### ► Abortive poliomyelitis

Abortive poliomyelitis is the minor illness occurring in approximately 5% of infected people. This is a febrile illness characterized by fever, headache, sore throat, loss of appetite, vomiting, and abdominal pain. Neurological symptoms are typically absent. The duration of this illness is usually less than 5 days.

### ► Nonparalytic poliomyelitis

Nonparalytic poliomyelitis also known as aseptic meningitis is caused by invasion of virus into the CNS. The symptoms of nonparalytic poliomyelitis are similar to those of abortive poliomyelitis but are more intense. Stiffness of the posterior muscles of the neck, trunk, and limbs is present in addition to the symptoms of the minor illness. This condition occurs in 1–2% of infected patients.

### ► Paralytic polio

This is the major illness, which occurs in 0.1–2% of individuals infected with poliovirus. This is the most severe manifestation of poliomyelitis and appears 3–4 days after the abortive poliomyelitis has subsided. This condition is caused due to invasion of virus from blood to the anterior horn cells of the spinal cord and the motor cortex of the brain. Depending on the various tissues or organs affected and the intensity of neuronal infection, poliomyelitis may be of two types, as follows:

**Paralytic poliomyelitis:** Paralytic poliomyelitis or spinal paralysis is characterized by spinal paralysis involving one or more limbs. Asymmetrical flaccid paralysis with no sensory loss is the typical manifestation. This condition is caused mostly by poliovirus type 1. This condition is seen in some of the vaccinated individuals following vaccination. This occurs due to reversion of the attenuated vaccine virus types 2 and 3 to virulence types. In this condition, there may be paralysis of only one limb, such as one leg or there may be complete flaccid paralysis of both the legs and hands. The condition may progress to death or may recover completely with residual paralysis.

**Bulbar poliomyelitis:** This is caused due to involvement of the cranial nerves, most commonly 9th, 10th, and 12th. This condition tends to be more severe with involvement of the muscles of the pharynx, vocal cords, and respiration. The condition may cause death in 75% of the patients.

### ► Postpoliomyelitis syndrome

This condition is sequelae of poliomyelitis, which may develop 20–40 years after infection with poliovirus. This condition is seen in 20–80% of patients who have recovered from poliomyelitis. Recurrence of weakness or fatigue is observed in this condition, and it usually involves the muscles that were initially affected by the poliovirus.

## Epidemiology

Poliovirus mainly affects children. However, individuals of any age may also develop the disease.

### Key Points

- Most epidemics of paralytic poliomyelitis are caused by poliovirus type 1, less commonly by type 3.
- Poliovirus type 2 is a common cause of paralytic poliomyelitis in India and is the causative agent of inapparent illness in Western countries.

## ► Geographical distribution

Polio continues to remain a major public health problem in developing countries. Six countries have been identified as endemic for poliomyelitis in the year 2003. These include Afghanistan, Egypt, Niger, Nigeria, Pakistan, and India. Significant progress has been made in reducing the prevalence of poliomyelitis in India. Efforts have been recently maximized to eliminate poliovirus infection in the very near future.

## ► Reservoir, source, and transmission of infection

Natural infection occurs only in humans. Infected humans excreting poliovirus in their stool are the major reservoir of infection. Infected stool containing poliovirus is the major source. The viruses secreted in throat secretions during early stage of the illness may also be another source of infection. The poliovirus is transmitted:

- primarily by the fecal-oral route by ingestion of food and water contaminated with human feces.
- by inhalation or through fomites contaminated with respiratory secretions.

Poor sanitation, low socioeconomic status, and crowded living conditions facilitate transmission of infection. Immunocompromised patients, such as those with HIV infection, B cell dysfunction, and IgA deficiency are particularly at high risk of developing poliomyelitis when exposed to poliovirus.

## Laboratory Diagnosis

### ► Specimens

Stool, throat swab, and cerebrospinal fluid (CSF) are the specimens used for isolation of the viruses. Viruses can be isolated from feces for more than 30 days during the illness and from the throat swab during the first few days of the illness. The virus is isolated rarely from the CSF specimens.

### ► Microscopy

Microscopy of the CSF shows a predominantly lymphocytic pleocytosis with the presence of 25–500 cells/mm<sup>3</sup>. The virus is rarely demonstrated in the CSF.

### ► Isolation of the virus

Isolation of viruses from clinical specimen by tissue culture is the most specific method in the diagnosis of poliomyelitis.

**Cell culture:** Virus isolation from feces and throat swab is carried out by cultivation on monkey kidney, human amnion, HeLa, Hep-2, Buffalo green monkey (BGM), MRC-5, and other cell cultures. The cytopathic effects produced by the virus are observed within 48 hours. These consist of cell retraction, increased refractivity, cytoplasmic granularity, and nuclear pyknosis. Identification of serotype is carried out by performing neutralization test. Differentiation of a wild virulent virus strain from that of an attenuated vaccine strain can be done by virulence

test in the monkeys and by performing polymerase chain reaction (PCR). Isolation of poliovirus from feces does not indicate a diagnosis of poliomyelitis, as large numbers of asymptomatic illnesses are seen. Hence, isolation of poliomyelitis virus from feces needs to be interpreted carefully along with clinical presentation of the disease.

## ► Serodiagnosis

Serodiagnosis is based on demonstration of a fourfold increase in the antibody titer of the serum collected at the time of acute illness and the period of convalescence. Neutralization or complement fixation test is carried out to demonstrate antibodies. Neutralizing antibodies appear early and are present throughout life. However, serodiagnosis is less frequently used for diagnosis of poliomyelitis.



### Molecular Diagnosis

PCR is a highly sensitive and specific test for diagnosis of poliomyelitis. The test, however, is not widely available in the developing countries.

## Treatment

No antivirals are available for the treatment of poliomyelitis.

## Prevention and Control

Poliovirus vaccines are the key component in prevention of polio and have played an important role in the effort to eradicate polio worldwide.

### Vaccines

Two types of vaccines used are as follows:

**Inactivated polio vaccine:** Inactivated polio vaccine or Salk vaccine was developed by Jonas Salk in 1956 for immunization against poliomyelitis. The vaccine contains formalin-inactivated strains of the three serotypes of the poliovirus grown in monkey kidney cell culture. The vaccine is given to children by deep subcutaneous or intramuscular injections in three doses. The vaccine is given at 2 months, 4 months, and at school entry, which is usually at 4 years. It does not cause development of vaccine-associated poliomyelitis (VAP).

The injection of the vaccine elicits the production of higher IgG antibody titers in the serum, but it does not stimulate the production of detectable level of secretory IgA in the gut, hence does not prevent alimentary tract infection. The main advantage of this vaccine is that since it uses killed viruses, it can be safely used for immunization in immunocompromised hosts. The disadvantages of this vaccine are that (a) it is not as immunogenic as oral polio vaccine, (b) it does not induce local mucosal immunity in the gut, and (c) it needs to be administered parenterally, which shows poor compliance.

**Live attenuated oral polio vaccine:** Live attenuated oral polio vaccine or Sabin vaccine was developed by Albert Sabin in the year 1962. It contains live attenuated strains of the three serotypes of poliovirus cultured in monkey kidney cells or human diploid cells. The vaccine is given orally, which causes

## Vaccines

natural infection. It elicits production of both local secretory IgA antibodies in the pharynx and alimentary tract, and humoral IgG antibodies in the serum. The virus lacks the capability to multiply in the CNS, hence is non-neurovirulent. The vaccine virus is excreted for several weeks in the feces during which the vaccine virus spread may occur to close contacts, inducing or boosting immunity in them. The first dose of vaccine is given to infants at age of 1½ months along with DPT. Second, third, and fourth doses of vaccine are given when children are raised to 2½, 3½, and 16–24 months, respectively.

Oral polio vaccine has been used since the 1960s. This vaccine has been mainly responsible for significant decrease in prevalence of disease throughout the world. The advantages of this vaccine are many: first, it induces local mucosal immunity; second, it provides appropriate herd immunity, and finally, it is cost-effective, especially in developing countries.

The major disadvantage of this vaccine is the loss of efficacy of the vaccine due to improper cold chain. Association of the vaccine with VAP is another major disadvantage. Although the virus content in this vaccine is attenuated, it may become neurotropic and may produce disease similar to wild type virus. The risk of VAP has been estimated at between 0.5 and 3.4 cases per million.

Advantages and disadvantages of Sabin and Salk vaccines are summarized in Table 60-3. Recently, a new monovalent oral poliovirus type I vaccine (MOPVI) has been introduced. This is used to eliminate some of the last poliovirus reservoirs in the endemic countries. The vaccine is contraindicated in children who are immunocompromised and also in those whose caretakers are immunocompromised.

## Coxsackieviruses

Coxsackieviruses are so named, because the viruses were first isolated in Coxsackie village in New York, United States, by Dandruff and Sickel in the year 1955. These viruses based on the pathological changes produced in suckling mice are classified into two groups: coxsackieviruses A and coxsackieviruses B.

## Key Points

- **Coxsackie A virus** produces generalized myositis, flaccid paralysis followed by death within a week in suckling mice.
- **Coxsackie B virus** produces patchy focal myositis, spastic paralysis, localized lesions in the liver, myocardium, pancreas, and brain, and brown fat pads.

The structure and morphology of the coxsackieviruses and the RNA genome are similar to those of poliovirus. But unlike poliovirus, they can infect mammals other than primates. Replication cycle is similar to that of poliovirus.

Coxsackie A viruses consist of 24 serotypes and are associated with diseases involving vesicular lesions, such as herpangina. Coxsackie B viruses consist of six serotypes and are most frequently associated with myocarditis and pleurodynia.

Coxsackie A viruses show tropism for skin and mucous membranes, whereas coxsackie B viruses show predilection for visceral organs, such as liver, heart, pancreas, and pleura. Both the viruses infect anterior horn cells of the motor neurons and meninges and cause paralysis. They replicate first in the oropharynx and gastrointestinal tract from where they spread by the blood circulation. Host immunity is IgG-antibody mediated and is type specific.

Coxsackievirus infection occurs worldwide. Humans are the only natural hosts. The viruses are transmitted primarily by fecal–oral route.

## Diseases Caused by Coxsackie A

Diseases specifically caused by coxsackie A viruses include the following:

**Herpangina:** This condition is caused by coxsackie A virus serotypes 2, 4, 5, 6, 8, and 10. The infection is most commonly

**TABLE 60-3** Advantages and disadvantages of polio vaccines

Vaccine	Advantages	Disadvantages
<b>Live (oral) vaccine</b>	Effective	Risk of vaccine-associated poliomyelitis in vaccine recipients
	Lifelong immunity	Not safe for administration to immunodeficient patients
	Induction of local immunity	Unstable—to be stored in cold conditions
	Induction of herd immunity	
	Ease of administration	
	No need for repeated booster vaccine	
	Cheap	
<b>Killed (parenteral) vaccine</b>	Useful in epidemics	
	Effective	Lack of induction of secretory antibody
	Stable	Booster dose needed for lifelong immunity
	Safe in immunodeficient patients	Costly
	No risk of vaccine-related disease	No community protection
		Not useful in epidemics

seen in children between 1 and 7 years. The symptoms include sudden onset of fever, sore throat, and difficulty in swallowing. The classical finding is a painful vesicular eruption of the oral mucosa around the soft palate and uvula. Less commonly, these lesions may be found on the hard palate. The condition is self-limiting. The viruses are isolated from the lesions or from the feces.

**Hand-foot-and-mouth disease:** This is a vesicular exanthema usually caused by coxsackievirus serotypes 5 and 16. This is mainly a disease of children, seen most commonly in patients younger than 10 years. After an incubation period of 3–6 days, the infection begins with prodromal symptoms, such as fever, cough, sore throat, malaise, and anorexia. After 12–36 hours, vesicular eruptions appear on the hands, feet, and oral cavity. This is a self-limiting condition and the illness subsides in a few days.

### Diseases Caused by Coxsackie B

Diseases specifically caused by coxsackie B viruses include the following:

**Pleurodynia:** This condition, also known as epidemic myalgia or Bornholm disease, is caused by coxsackie B virus serotypes 3 and 5. This condition is an acute illness, which manifests with a sudden onset of fever accompanied by muscular pain and pain in the chest and abdomen. The pain is spasmodic in nature. The condition usually lasts for 4 days but may relapse again after the condition has been asymptomatic for several days.

**Myocarditis:** This is a serious condition caused by coxsackie B virus, mostly in newborn infants. Shortness of breath, dull or sharp chest pain, and fever are the common manifestations of the condition. This is a life-threatening condition mostly in newborns. In adults, the condition presents with myocardial infection with fever. The condition is associated with a high morbidity.

### Diseases Caused by Coxsackie A and B

Diseases caused by both coxsackie A and B viruses include aseptic meningitis.

**Aseptic meningitis:** The condition is caused by coxsackie A serotypes 2, 4, 7, and 9 and by coxsackie B viruses. The laboratory diagnosis of coxsackievirus infection is made by isolation of the virus from the feces or from lesions by intracerebral or intraperitoneal inoculation into a 1-day-old mouse. Identification of

the virus is carried out by histopathology study of the infected mouse after sacrifice. Some of the coxsackieviruses can also be isolated by culture in human diploid embryonic lung fibroblasts, BGM, and HeLa cell lines. Cytopathic effects resemble those of polioviruses but develop more slowly, beginning as foci of rounded refractile cells, which die and fall off the glass. Differences between coxsackieviruses A and B are summarized in Table 60-4.

### Echoviruses

Echoviruses were originally isolated from the feces of an individual who had no clinical illness and caused a cytopathic effect in the cell culture. The prefix ECHO is an acronym for enteric cytopathogenic human orphan viruses (ECHO viruses). They were earlier called “orphans”, because these viruses were not associated earlier with any disease but now they are known to cause a variety of human illnesses.

The echoviruses resemble other enteroviruses in their properties. They are classified into 32 serotypes (1–34 except 10 and 28) on the basis of their type-specific neutralization capsid antigen. Some serotypes of echoviruses (types 3, 6, 7, 11, 12, 13, 19, 20, 21, 24, 29, 30, and 33) cause hemagglutination of human red cells. Agglutination of red cells is followed by elution, making the red cells inagglutinable by echoviruses or coxsackieviruses but not by myxoviruses.

All echoviruses grow in human and monkey kidney cell lines, producing cytopathic effects. Humans are the natural hosts for these viruses. Echoviruses are found in the intestinal tract of the infected humans. The infection like other enterovirus is transmitted by fecal–oral route.

Most of the echoviruses cause asymptomatic infections in humans, but some of them have been associated with many clinical syndromes. Nonspecific febrile illness associated with rash, headache, and common-cold-like symptoms is caused by many serotypes of echoviruses. Aseptic meningitis is also caused by echoviruses. Some strains of echovirus have been associated with gastroenteritis (serotype 8) and respiratory diseases in children (serotypes 1, 11, 19, 20, and 22).

Laboratory diagnosis of echovirus infection is made by isolation of viruses from feces, throat swab, or CSF. They are cultured using human diploid embryonic lung fibroblast and human rhabdomyosarcoma cell lines. The growth of the virus is detected by cytopathic changes, which is similar to that of other coxsackieviruses.

TABLE 60-4

Differences between coxsackie A and coxsackie B viruses

Properties	Coxsackie A	Coxsackie B
Serotypes	23 (1–24 except 23)	6 (1–6)
Pathological changes produced in suckling mice	Generalized myositis, flaccid paralysis, and death within a week	Patchy focal myositis, spastic paralysis, necrosis of brown fat, pancreatitis, hepatitis, and myocarditis
Growth in monkey kidney cell culture	+	+

## Other Enteroviruses

Four new enteroviruses have been described that include enteroviruses 68, 69, 70, and 71. Of these, enterovirus 69 does not cause any human diseases, but rest of the three enteroviruses cause diseases in humans. Type 68 causes pneumonia and bronchitis, type 70 causes acute hemorrhagic conjunctivitis (AHC), and type 71 causes meningoencephalitis and paralysis.

## Enterovirus 70

Enterovirus 70 is the causative agent of acute hemorrhagic conjunctivitis (AHC). The condition was first recognized in 1969 in Ghana and Indonesia. Subsequently, the condition spread widely, involving several parts of Japan, England, Europe, Africa, Middle East, and Southeast Asia including India. Coxsackievirus A 24 has also been known to cause the similar disease.

AHC is a highly contagious ocular infection, which can cause large-scale epidemics. Transmission is facilitated by overcrowding and nonsanitary conditions. The infection is transmitted directly from finger or fomite to eye. The condition is most prevalent in adults between 20 and 50 years.

The incubation period is about 24 hours, and the onset is abrupt. The most common symptoms include pain in the eyes, burning sensation, swelling of the eyelids, and foreign body sensation in the eye. Photophobia and watery discharge may also be found in some cases. The other eye becomes infected a few hours after infection of the first eye. Fever, malaise, and headache are the nonspecific symptoms. AHC is a self-limiting condition. The symptoms typically improve by second or third day of infection, and the recovery is complete within 7–10 days.

Isolation of the virus is made by culturing in human diploid embryonic kidney and HeLa cell lines.

## Rhinoviruses

Rhinoviruses are the most important causative agents of common cold and upper respiratory tract infections. Earlier, many viruses isolated from the cases of common cold were known as common cold viruses, Salisbury viruses, or Muri viruses. Now all these viruses have been given the name rhinoviruses (*rhino* referring to the organ specifically affected).

Rhinoviruses are small RNA viruses, morphologically resembling other picornaviruses. They grow better *in vivo* at a temperature of 30°C than at 37°C, a property that contributes partially for predilection of these viruses for the cooler environment of the nose and conjunctiva. The rhinoviruses have been classified into more than 102 serotypes on the basis of a type-specific antigen in their capsids.

Rhinoviruses differ from other picornavirus in being more acid labile and more heat stable. They are inactivated at a low pH below 5 and become completely inactive at pH 3. They are relatively stable at 20–37°C and can survive on environmental surfaces, such as door knobs, for several days. Some serotypes

TABLE 60-5

### Differences between enteroviruses and rhinoviruses

Property	Enteroviruses	Rhinoviruses
<b>Size</b>	22–30 nm	30 nm
<b>Capsid:</b>		
Symmetry	Icosahedral	Icosahedral
Genome	RNA, single stranded, positive sense	RNA, single stranded, positive sense
Polypeptides	VP1–VP4	VP1–VP4
<b>Optimum temperature for growth</b>	37°C	33°C
<b>Effect of acid</b>	Stable (pH 3.9)	Labile (pH 3.5)
<b>Density in cesium chloride (g/mL)</b>	1.34	1.39–1.42

may survive heating at 50°C for 1 hour. They are resistant to 20% ether and 5% chloroform but are sensitive to hypochlorite and aldehyde. Differences between enteroviruses and rhinoviruses are summarized in Table 60-5.

Rhinoviruses grow at 37°C in cell lines of human or simian origin in the presence of good oxygenation, low pH (7 or less), and low temperature. They can grow in human embryonic tracheal epithelial, human diploid cell lines, and HeLa cells, but without producing conspicuous cytopathic effects. Some strains grow well in both monkey and human cell lines and are designated as M strains, and those that grow only on human cells are known as H strains.

Infection is transmitted to other susceptible human hosts by nasal secretions expelled from the nose of a patient during sneezing and coughing. Infection can be initiated by as little as one infectious viral particle. During the acute phase of illness, nasal secretions contain approximately 500–1000 infectious virions/mL of secretions. Also, these secretions may contaminate hands, fingers, handkerchiefs, or paper tissues, and the normal susceptible hosts who come in contact with these contaminated surfaces acquire the virus. The virus enters through the nose, mouth, or eyes and causes infections of the upper respiratory tract including the throat.

The infection occurs mostly by multiplication of the virus in the nose. The onset and severity of the symptoms usually correlate with the quantity of viruses excreted in the nasal secretion and the time of viral shedding. Infected cells release bradykinin and histamine, which cause a running nose. The progression of infection is limited by an interferon which is produced in nasal secretion in response to the nasal infections. However, the cytokines produced during infection can promote the spread of the virus by enhancing the expression of inter-CAM-1 viral receptor.

Host immunity in rhinoviruses is characterized by both humoral and cell-mediated immunities. Humoral immunity is characterized by the production of both nasal secretory IgA and serum IgG antibodies within a week of infection. The cell-mediated immunity does not play any important role in controlling rhinovirus infection. Immunity is transient and

is usually serotype specific. Therefore, one attack of common cold by rhinovirus does not confer immunity against subsequent attacks due to presence of numerous serotypes of the virus.

Rhinoviruses are the major cause of common cold and are responsible for more than 50% of all colds worldwide. Other viruses which may also cause common cold include coronaviruses, coxsackieviruses A21 and A24, echoviruses 11 and 20, and parainfluenza viruses.

Rhinovirus causes common cold after an incubation period of 2–4 days. The condition begins as an upper respiratory infection with sneezing, soon followed by a running nose (*rhinorrhoea*). Rhinorrhoea then increases and is associated with symptoms of nasal obstruction. Mild sore throat, headache, malaise, fever, and rigor sometimes accompany rhinovirus infection. Usually, symptoms subside in about a week, but in some cases the cough and nasal symptoms may persist for 7–10 days or longer. The clinical manifestations of the common cold are characteristic; hence laboratory diagnosis may not be necessary.

Infected humans suffering from acute illness are the only reservoirs and sources of rhinovirus that cause common cold. Asymptomatic people also play an important role in transmitting the infection even though they shed few viruses in their respiratory secretions.

Rhinovirus is transmitted mainly by two routes: first, by direct inhalation of infectious droplets and second, by direct contact with hands or fomites contaminated with respiratory

droplets. Contaminated hands appear to be the major route of transmission, and direct person-to-person contact is the major mode of spread of infection. Common cold occurs most commonly in infants and in children and occurs most frequently in the early autumn and the late spring in people living in temperate climates. The nonenveloped rhinoviruses are extremely stable and survive on external objects, such as fomites for many hours, thereby facilitating transmission of infection.

- Laboratory diagnosis is made by isolation of the virus from nasal washing by culture on human diploid fibroblast cells (e.g., WI-38 at 33°C).
- The rhinoviruses are identified by their typical cytopathic effects and demonstration of acid lability.
- Serotyping of the strains is performed with the use of pools of specific neutralizing antisera.

Treatment of the condition is symptomatic. No vaccine is available against rhinovirus. Hand washing and disinfection of contaminated objects are the best methods of preventing transmission of the virus.

## Hepatitis A Virus

Hepatitis A virus, formerly known as enterovirus, has now been accorded the status of a separate genus *Hepatovirus* of the family Picornaviridae. The virus is discussed in detail in Chapter 66.



### CASE STUDY

A 7-year-old girl came to a hospital with flaccid paralysis of right leg. Her parents provided the history of paralysis for the past 2 weeks. On examination, no sensory loss was elicited in the affected right leg. The girl was suspected to be suffering from paralytic poliomyelitis. On enquiry, the parents gave the history of the girl receiving oral polio vaccine during her childhood.

- What is the cause of vaccination failure in this girl?
- What are the countries in the world in which polio still continues to be endemic?
- What are the mechanisms of pathogenesis of poliomyelitis?
- How would the diagnosis be confirmed in the laboratory?



# Orthomyxoviruses

## Introduction

The term myxovirus was coined for a group of enveloped RNA viruses that have the ability to adsorb onto mucoprotein receptors on erythrocytes, causing hemagglutination. It included influenza, mumps, parainfluenza, and Newcastle disease viruses.

## Classification

All these viruses were grouped under myxovirus (*myxa* meaning mucus) due to their affinity to mucins. The influenza, mumps, parainfluenza, and Newcastle disease viruses were initially grouped in this class. However, two separate families were created subsequent to the recognition of clear differences between these viruses. These two families are: Orthomyxoviridae, consisting of influenza viruses, and Paramyxoviridae, consisting of parainfluenza, mumps, measles, respiratory syncytial, and Newcastle disease viruses. Differences between orthomyxoviruses and paramyxoviruses are summarized in Table 61-1.

The genus *Orthomyxovirus* includes influenza viruses, the causative agents of worldwide epidemics of influenza. Human diseases associated with influenza virus are presented in Table 61-2.

TABLE 61-1

**Differences between orthomyxoviruses and paramyxoviruses**

Properties	Orthomyxoviruses	Paramyxoviruses
<b>Size</b>	80–120 nm	100–300 nm
<b>Shape</b>	Spherical	Pleomorphic
<b>Genome</b>	Segmented—eight pieces of RNA	Single, linear RNA
<b>Gene reassortment</b>	Common	Not reported
<b>Antigenic stability</b>	Variable	Stable
<b>Hemolysis</b>	Absent	Present
<b>Site of synthesis of ribonucleoprotein</b>	Nucleus	Cytoplasm
<b>DNA-dependent RNA synthesis</b>	Required for multiplication of the virus	Not required for the multiplication of the virus

TABLE 61-2

**Diseases associated with influenza virus infection**

Disease	Symptoms
Influenza in adults	Fever, malaise, myalgia, sore throat, and nonproductive cough
Influenza in children	Acute disease similar to that in adults but with high fever, abdominal pain, vomiting, otitis media, myositis, and croup
Complications	Primary viral pneumonia; secondary bacterial pneumonia; neurological complications, such as Guillain-Barre syndrome, encephalopathies, encephalitis, and Reye's syndrome

## Influenza Viruses

Influenza viruses are classic respiratory viruses. They cause influenza, an acute respiratory disease, with well-defined systemic symptoms. Influenza is an acute infectious disease of the respiratory tract that occurs in sporadic, epidemic, and pandemic forms.

## Properties of the Virus

### ► Morphology

Influenza viruses show following features:

- Influenza viruses are spherical or filamentous, enveloped particles 80–120 nm in diameter.
- Influenza virus is composed of a characteristic segmented single-stranded RNA genome, a nucleocapsid, and an envelope (Fig. 61-1).
- The viral genome is a single-stranded antisense RNA. The genome consists of an RNA-dependent RNA polymerase, which transcribes the negative-polarity genome into mRNA. The genome, therefore, is not infectious. The viral RNA has a molecular weight of 5 million daltons and a length of 13,600 nucleotides. Characteristically, it is segmented and consists of seven or eight segments. These segments code for different proteins which are NS1, NS2, NP, M1, M2, M3, HA, and NA.
- The genome is present in a helically symmetric nucleocapsid surrounded by a lipid envelope. The envelope has an inner membrane protein layer and an outer lipid layer. The membrane proteins are known as matrix or M protein and are composed of two components M1 and M2.

- Two types of spikes or peplomers project from the envelope: (a) the triangular *hemagglutinin* (HA) peplomers and (b) the mushroom-shaped *neuraminidase* (NA) peplomers.

### ► Viral replication

Influenza virus, hepatitis delta virus, and retroviruses are the only RNA viruses that have an important stage of their replication cycle in the nucleus. Infection of the host cell begins by adsorption of the cell by influenza virus, which is mediated through the HA. HA is first cleaved by an extracellular protease to a modified HA that actually mediates the attachment of the virus to the cell surface. Once inside the cell, the virus uncoats within the endosome.

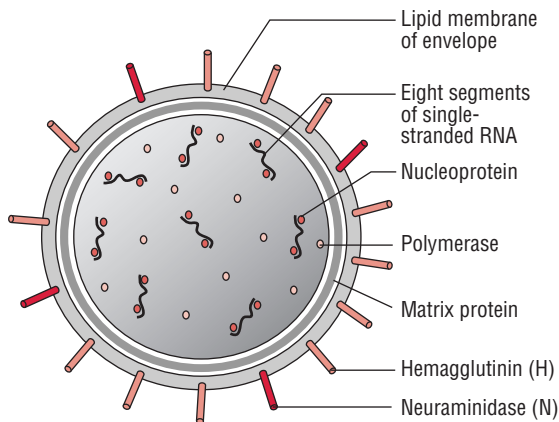

FIG. 61-1. Schematic diagram of structure of an influenza virus.

In the nucleus of the host cell, the virion RNA polymerase transcribes the eight-genome segments into eight viral mRNAs. Most of the viral mRNAs, however, move out of the nucleus into the cytoplasm, where they are translated into viral proteins. Some of the viral mRNAs continue to remain in the nucleus and serve as the templates for synthesis of the negative-strand RNA genomes for the progeny virions. In the nucleus also, two proteins, namely, nucleoprotein (NP) and matrix protein are synthesized, which then bind with the RNA genome of the viral progeny and form a complex, which is subsequently transported to the cytoplasm.

Matrix protein mediates the interaction of the nucleocapsid with the envelope, and finally, the virion is released from the cell by budding from the cell membrane at the site where the HA and NAs are present.

### ► Antigenic and genomic properties

Influenza viruses have two types of antigens:

**Group-specific antigens:** The ribonucleoprotein (RNP) antigen, or the “soluble” antigen, or the internal antigen is the group-specific antigen. Influenza viruses are divided into types A, B, and C on the basis of variation in this nucleoprotein antigen.

**Type-specific antigens:** The surface antigen, or “viral” antigen, or “V antigen” is composed of two virus-encoded proteins, HA and NA, which are the type-specific antigens (Fig. 61-2).

**Hemagglutinin:** HA is a trimer and is composed of two polypeptides, HA1 and HA2, responsible for hemadsorption and hemagglutination. The hemagglutinin consists of 500 spikes,

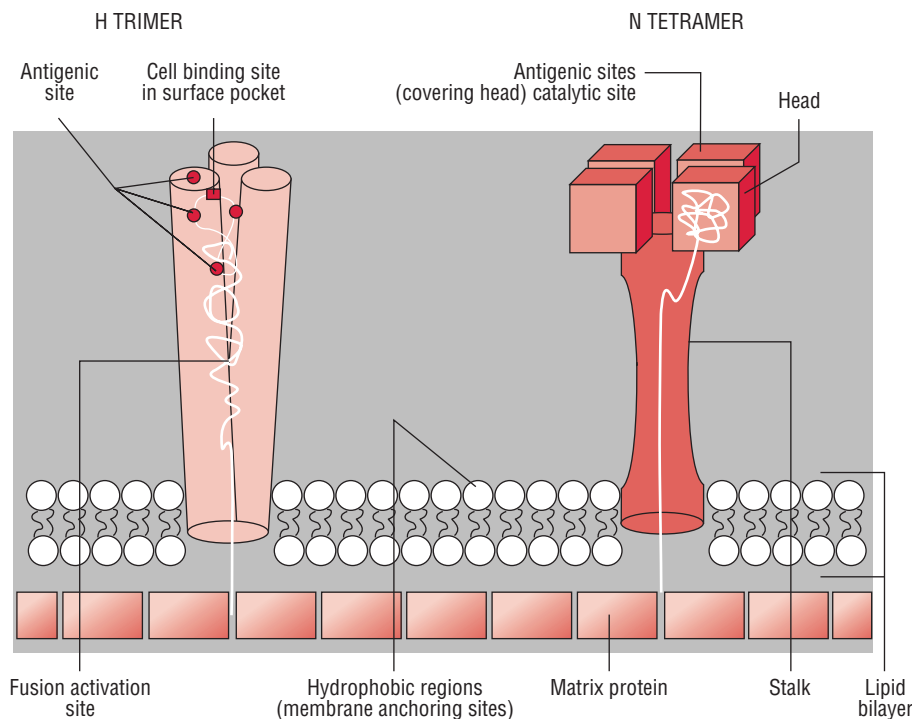

FIG. 61-2. Schematic diagram of H trimer and N tetramer of influenza virus.

each measuring 12 nm in length. The triangular-shaped HA is inserted into the virus membrane by its tail end. The distal end, which contains five antigenic sites (designated as HA1–HA5), is responsible for binding of virion to host cells.

Influenza viruses adsorb many avian and mammalian erythrocytes. Hemagglutinin binds with the neuraminic acid (sialic acid) cell receptor, the cell surface glycoprotein receptor, and initiates the infection in the host cell. Adsorption of erythrocytes occurs at 4°C, but at 37°C there is detachment of the red cells due to destruction of the glycoprotein receptors by the viral enzyme, neuraminidase. The hemagglutinin agglutinates certain red blood cells, which is inhibited by the neutralizing antibodies. This forms the basis of the hemagglutination inhibition test used in the serodiagnosis of influenza.

Hemagglutinin has potency to undergo antigenic variations. The nucleotide and amino acid sequences of the polypeptides, HA1 and HA2, undergo radical changes in antigenic shift. In antigenic drift, only minor changes take place in the compositions of HA antigenic sites.

**Neuraminidase:** The NA is a glycoprotein and tetramer. It consists of 100 mushroom-shaped spikes. The mushroom-shaped NA is inserted into the virus membrane by its hydrophobic tail end. The distal end contains antigenic as well as enzymatically active sites. The NA causes hydrolysis of *N*-acetyl neuraminic acid or sialic acid residues present on the glycoprotein receptors on red cells, hence causes elution or detachment of the cells adsorbed to virion particles. The function of the neuraminidase is to cleave the neuraminic acid and to release progeny virions from the infected host cells. The neuraminidase also degrades the mucus layer, thereby exposing the epithelial membrane of the respiratory tract for infection by the virus.

All the strains of influenza A, B, and C share the common internal proteins, such as nucleoproteins and membrane proteins. They, however, differ in their surface proteins, such as HAs and NAs. The influenza viruses are further subdivided into subtypes, A0, A1, A2, and A3, and these subtypes into strains.

### ▶ Antigenic variations

Antigenic variation is a unique feature of influenza virus. The surface antigens HA and NA show variations and are primarily responsible for antigenic variations exhibited by influenza viruses. The internal RNP antigen and M protein are stable, hence do not contribute to the antigenic variations. Antigenic variations are of two types: antigenic shift and antigenic drift.

**Antigenic shift:** The abrupt, drastic, discontinuous change is called the antigenic shift. This occurs due to major antigenic changes in HA or NA antigens, and is caused by replacement of the gene for HA by one coding for a completely different amino acid sequence. The antigenic shift is characterized by alteration of virtually all the antigenic sites of the HA. This occurs independently in the HA and NA.

**Antigenic drift:** The gradual, sequential, regular antigenic change in influenza virus is known as antigenic drift. This

TABLE 61-3

### Differences between antigenic shift and antigenic drift

Antigenic shift	Antigenic drift
Abrupt, drastic, and discontinuous variation in antigenic structure	Gradual, sequential, and regular variation at periodic intervals
Results in a different strain Related to predecessor strain	Results in a new strain Not related to predecessor strain
Antigenic drift is due to mutation and selection	Antigenic shift is due to gene reassortment
Responsible for epidemics of influenza	Responsible for epidemics as well as pandemics of influenza

occurs due to minor antigenic changes in the HA or NA occurring at frequent intervals. This is caused even by a single mutation affecting HA glycoprotein. The antigenic drift is characterized by changes in certain epitopes in the HA, while others are being conserved.

Differences between antigenic shift and antigenic drift are summarized in Table 61-3.

### Key Points

- Influenza A virus shows maximum antigenic variations.
- Influenza B virus does not undergo antigenic shift because influenza B virus is the only human virus for which there is no animal source of new RNA segments. However, influenza B virus undergoes antigenic drift.
- Antigenic variation never occurs in type C influenza virus.

### ▶ Gene reassortment

Because the influenza virus genome is segmented, genetic reassortment can occur when a host cell is infected simultaneously with viruses of two different parent strains. This process of genetic reassortment accounts for the periodic appearance of the novel types of influenza A strains that cause influenza pandemics.

Influenza viruses of animals, such as aquatic birds, chickens, swine, and horses show high host specificity. These animal viruses are the source of the RNA segments that encode the antigenic shift variants that cause epidemics among humans. For example, if a person is infected simultaneously by an avian and human influenza strains, then it is possible that a genetic reassortment could occur in infected cells in humans. The reassortment could lead to emergence of a new human influenza A virus, the progeny of which will contain a mixture of genome segments from the two strains (e.g., a new variant of human influenza A virus bearing the avian virus HA) (Fig. 61-3).

Many studies have conclusively demonstrated that the aquatic birds (such as water fowl) are a common source of these new genes. The pigs act as mixing vessels, where these virulent genes of water fowl mix with the genome of influenza virus giving rise to new variant of influenza virus.

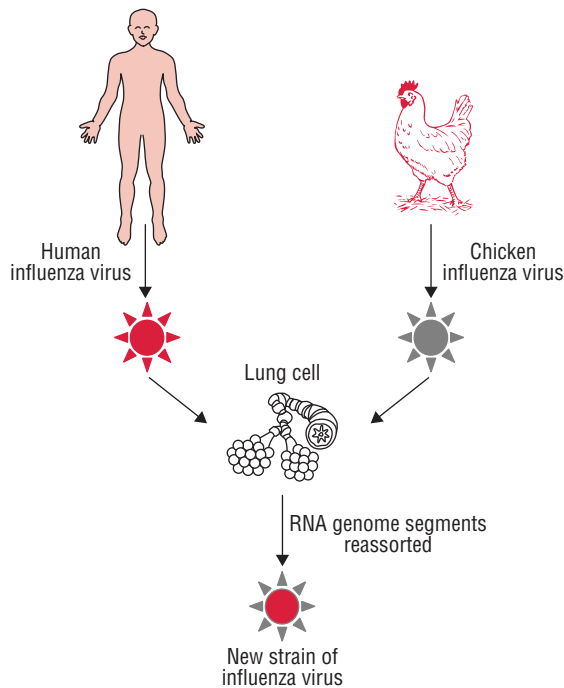

FIG. 61-3. Genetic reassortment between a human and animal virus.

### ► Designation of influenza viruses

Influenza virus type A can be classified into subtypes based on the variations in their surface antigens (Table 61-4). The WHO proposed a new system of classification in 1971 and was later modified, which takes into account the nature of both the surface antigens. According to this, the complete designation of a strain will include the (*a*) type, (*b*) place of origin, (*c*) serial number, and (*d*) year of isolation followed by (*e*) antigenic subtypes of the HA and NA in parentheses. For example: influenza A/Singapore/1/57 (H2N2) indicates that influenza was first originated from Singapore and was isolated for the first time in the year 1957. The HA and NA antigens are H2 and N2 as shown in the parentheses.

### ► Other properties

Influenza viruses are inactivated by ether, formaldehyde, phenol, salts of heavy metals, and common chemical disinfectants. Heating at 50°C for 30 minutes inactivates most strains of the virus. Influenza viruses are resistant to slow drying. They remain viable in dust up to 2 weeks, at -70°C for a longer period, and by freeze-drying indefinitely.

TABLE 61-4

Types and subtypes of influenza virus

Family	Types (genus)	Subtypes (species)
Orthomyxoviridae	Influenza virus A	H1N1 (A1 human, H <sub>sw</sub> N1), H2N2 A2, H3N2 (A3, A Hong Kong)
	Influenza virus B	B (human)
	Influenza virus C	C (human)

## Virus Isolation and Animal Susceptibility

Influenza viruses are isolated from respiratory secretions by growing in chick embryos or tissue cultures (monkey kidney or baboon kidney cell lines).

### ► Chick embryos

The influenza viruses grow in the allantoic and amniotic cavity of the chick embryos. After an incubation period of 3 days, the fluid is tested for hemagglutination activities of the viruses.

### ► Cell culture

Cell lines are widely used for culture of influenza viruses. They can grow in several primary and continuous cell lines. Rhesus Monkey kidney cell lines (LLC-MK2) and Madin-Darby canine kidney (MDCK) are the continuous cell lines frequently used to isolate influenza viruses.

### ► Laboratory animals

Human influenza virus causes experimental infections in a variety of animals. Intracerebral inoculation of mice by neurotrophic strains produces fatal encephalitis. It causes an acute respiratory disease on intranasal inoculation in ferrets.

## Pathogenesis and Immunity

Influenza virus is transmitted from person to person primarily in droplets released by sneezing and coughing.

### ► Pathogenesis of influenza

Inhaled influenza viruses reach lower respiratory tract, tracheobronchial tree, the primary site of the disease. They attach to sialic acid receptors on epithelial cells by HA present on the viral envelope. Relatively few viruses are needed to infect lower respiratory tract than the upper respiratory tract.

Neuraminidase of the viral envelope may act on the *N*-acetyl neuraminic acid residues in mucus to produce liquefaction. In concert with mucociliary transport, this liquefied mucus may help spread the virus through the respiratory tract. Infection of mucosal cells results in cellular destruction and desquamation of the superficial mucosa. The resulting edema and mononuclear cell infiltration of the involved areas are accompanied by symptoms including nonproductive cough, sore throat, and nasal discharge. Although the cough may be striking, the most prominent symptoms of influenza are systemic: fever, muscle aches, and general prostration. The virus remains localized to the respiratory tract; hence viremia does not occur.

In an uncomplicated case, virus can be recovered from respiratory secretions for 3–8 days. Peak quantities of 10<sup>4</sup>–10<sup>7</sup> infectious units/mL are detected at the time of maximal illness. After 1–4 days of peak shedding, the titer begins to drop, in concert with the progressive abatement of disease.

Occasionally, in patients with underlying heart or lung disease, the infection may extensively involve the alveoli, resulting in interstitial pneumonia, sometimes with marked accumulation of edema and lung hemorrhage. Pure viral pneumonia of this type is a severe illness with a high mortality. Virus titers in secretions are high, and viral shedding is prolonged. In most cases, however, pneumonia associated with influenza is caused by bacteria, principally pneumococci, staphylococci, and Gram-negative bacteria. These bacteria can invade and cause disease, because the preceding viral infection damages the normal defenses of the lung.

### ► Host immunity

Antibody is the primary defense in immunity to reinfection. IgA antibody, which predominates in upper respiratory secretions, is less persistent than secretory IgG, but contributes to confer immunity. Secretory IgG antibody, which predominates in lower respiratory secretions, appears to be the most important.

Antibodies provide long-lasting immunity against the infecting influenza strain. Only antibodies directed against HA is able to prevent infection. Antibodies against HA neutralizes the infectivity of the virus, thereby preventing the disease. Antibodies against NA do not neutralize infectivity but reduce severity of the disease. They act presumably by impairing the action of NA against *N*-acetyl neuraminic acid residues in the virion envelope and thus promoting virus aggregation. The antibodies against the internal ribonucleoprotein group-specific antigen do not confer any immunity.

Immunity to influenza virus is strain-specific and lasts for many years. Recurrent cases of influenza are caused primarily by antigenically different strains. The role of cell-mediated immunity in conferring protection against influenza is not clear.

## Clinical Syndrome

The virus causes classic influenza syndrome.

### ► Influenza syndrome

Incubation period is short (1–3 days). The classic influenza syndrome is a febrile illness of sudden onset, characterized by tracheitis and marked myalgias. Headache, chills, fever, malaise, myalgias, anorexia, and sore throat appear suddenly. The body temperature rapidly rises to 101–104°F (38.3–40.0°C) and respiratory symptoms ensue. Nonproductive cough is characteristic.

Sneezing, rhinorrhea, and nasal obstruction are common. Patients may also report photophobia, hoarseness, nausea, vomiting, diarrhea, and abdominal pain. They appear acutely ill and are usually coughing. Minimal to moderate nasal obstruction, nasal discharge, and pharyngeal inflammation may be present. Lung examination is usually normal.

The viruses mostly cause subclinical infections. They do not display the classic syndrome described above. Moreover, the influenza syndrome is uncommon in children and is not seen in infants. A given patient may exhibit symptoms including predominantly sneezing, nasal obstruction, and nasal discharge

(common cold); nasal obstruction, discharge, and sore throat (upper respiratory illness); sore throat with erythema (pharyngitis); hoarseness (laryngitis); or cough (tracheobronchitis). Fever may be absent.

## Complications

**Secondary bacterial infections:** Life-threatening influenza is often caused by secondary bacterial infections with staphylococci, pneumococci, and *Haemophilus influenzae*. Pneumonia may develop as a complication and may be fatal, particularly (a) in elderly persons above 60 years with underlying chronic disease, (b) in people with impaired resistance (chronic cardiopulmonary disease, renal disease, etc.), and (c) in pregnant women.

**Central nervous system complications:** Guillain-Barré syndrome characterized by encephalomyelitis and polyneuritis is a rare complication of influenza virus infection. This condition was documented in the United States in the year 1976, following extensive vaccination with inactivated H3N2 influenza virus.

**Other complications:** Reye's syndrome is a noted complication of influenza B infection. The condition is seen most commonly in young children and is associated with degenerative changes in the brain, liver, and kidney.

## Epidemiology

Influenza occurs worldwide.

### ► Geographical distribution

Influenza viruses cause epidemic, endemic, and pandemic influenza. Influenza A virus causes epidemics and occasionally pandemics; influenza B virus only causes epidemics; and influenza C viruses only cause minor respiratory illness and do not cause any epidemics. Influenza epidemics have been recorded throughout the history. The worst of these was the 1918 pandemic, which caused about 20 million deaths worldwide and about 500,000 deaths in the United States. In temperate climates, the epidemics typically occur in the winter and cause considerable morbidity in all age groups.

Influenza occurs throughout India. The worst, severe pandemic in the year 1918–1919 (Spanish flu) caused nearly 10 million deaths in India.

### ► Reservoir, source, and transmission of infection

Infected humans are the main reservoir of infections for influenza A virus. Respiratory secretions of infected persons are the important source of infection. The virus is excreted in respiratory secretions immediately before the onset of illness and for 3–4 days thereafter. Wild aquatic birds are known reservoirs of influenza A. They secrete the viruses in their feces, which contaminates ponds and lakes. The virus is spread from person-to-person primarily by air-borne respiratory droplets released during the acts of sneezing and coughing.

Influenza B virus only causes epidemics. Infection is from humans-to-humans. No animal reservoir hosts are known.

Influenza C virus only causes minor respiratory illness and does not cause any epidemics.

### ► Influenza epidemics and pandemics

Influenza epidemics are of two types. Yearly epidemics are caused by both type A and type B viruses. The rare, severe influenza pandemics are always caused by type A virus. Antigenic shift and antigenic drift are the two different mechanisms responsible for producing the strains that cause these two types of epidemics.

**Antigenic shift:** A major change in one or both of the surface antigens, a change that yields an antigen showing no serologic relationship with the antigen of the strains prevailing at the time is called antigenic shift. Antigenic shift has been demonstrated in type A influenza virus only.

Influenza A virus causes epidemics and occasionally, pandemics. Pandemics are caused by the virus strains undergoing antigenic shift. Antigenic shift variants appear less frequently, about every 10 or 11 years. It is demonstrated that pandemic strains are the recombinant strains, originated from some animal or bird reservoir, either spreading to humans directly by host range mutation or as a result of a recombination between human and nonhuman strains. The pandemic strains also show the capability to spread rapidly among the population.

The completely novel antigens that appear during antigenic shift are acquired by genetic reassortment. The donor of the new antigens is probably an animal influenza virus. Type A viruses have been identified in pigs, horses, and birds, and animal influenza viruses possessing antigens closely related to those of human viruses. Fourteen distinct HA and nine NA antigens are known. Since continued surveillance of animal influenza viruses in recent years has failed to discover new antigens, these may represent the full variety of major influenza virus surface antigens (subtypes).

**Antigenic drift:** Repeated minor antigenic changes, on the other hand, generate strains that retain a degree of serologic relationship with the currently prevailing strain. This is called antigenic drift. The epidemics are caused by influenza A virus undergoing antigenic variations due to antigenic drift resulting from mutations and selections. Antigenic drift variants occur very frequently, virtually every year. This is responsible for emergence of the strains that cause yearly influenza epidemics. When persons are reinfected with drift viruses, the serum antibody responses to the surface antigens that are shared with earlier strains to which the person has been exposed are frequently stronger and of greater avidity than are the responses to the new antigens. This phenomenon, which has been called “*original antigenic sin*” is sometimes useful in serologic diagnosis. Antigenic drift represents selection for naturally occurring variants under the pressure of population immunity.

Influenza A is generally more pathogenic than influenza B. Influenza A is a zoonotic infection and more than 100 types of influenza A viruses have been described which infect birds, pigs, horses, dogs, and seals. The 1918 pandemic of influenza that resulted in millions of human deaths worldwide is believed to have originated from a virulent strain of H1N1 from pigs or birds (Table 61-5).

TABLE 61-5

### Prevalence of antigenic subtypes of influenza virus type A

Period of prevalence	Antigenic structure	Type of antigenic variation
1918–1919	H1N1	Antigenic shift
1918–1957		Progressive antigenic drift
1957	H2N2	Antigenic shift
1957–1968		Progressive antigenic drift
1968	H3N2	Antigenic shift
1968–1990		Progressive antigenic drift
1976	H1N1	Reappearance of Swine H1N1 virus
1977	H1N1	Reappearance of H1N1 virus (resembling 1950 strain)
1977–1978		Progressive antigenic drift
1989	H1N1	Reappearance of Swine H1N1 virus

### ► H5N1 bird flu

The H5N1 flu, caused by an avian subtype influenza virus, which has been associated with bird flu in the domesticated birds, can be transmitted from birds to humans. The H5N1 was first described in Hong Kong in 1997. Human infections caused by this virus were established in only 18 individuals of which six died. Since then, sporadic cases of H5N1 infection continued to be described in southern China.

An epidemic of bird flu occurred in domesticated birds in Southeast Asia, primarily Vietnam, in January 2004. More than 240 human cases have been documented and more than 140 persons have died due to the poultry outbreaks and bird-to-human transmission. Most deaths have been reported in Vietnam and Indonesia. Sporadic outbreaks have continued to occur since the 2004 outbreak even outside Southeast Asia, including Turkey.

Till now, no conclusive evidences are available to show the human-to-human transmission of H5N1. However, scientists are concerned that a slight mutation could convert H5N1 to a strain that would be easily transferred from human-to-human. Such a strain, it is believed, could potentially spread rapidly and cause a catastrophic worldwide pandemic. Hence, efforts are currently underway to develop an effective vaccine against H5N1. In addition, the number of drugs that are effective against influenza are being increasingly evaluated. Ribavirin has shown activity when tested in animal models.

Another avian subtype, H9N2, was described in two young children in March 1999. However, after that despite concern, no further outbreak of H9N2 infection has been documented. Experts are also concerned that a virulent strain of H9N2 influenza similar to H5N1 flu may mutate to allow human-to-human infection and that such a strain may possess the combination of transmissibility, infectivity, and lethality.

## ► H1N1

A novel H1N1 swine origin influenza virus (SOIV) H1N1 emerged in 2009 to produce the first human influenza pandemic of the twenty-first century. Within 1 year, this virus spread to 214 countries and caused more than 18,000 confirmed deaths worldwide. First described in April 2009, the novel swine origin influenza virus emerged due to a “triple-reassortment” of influenza viruses of avian, swine, and human origin. This led to the popular term “swine flu” being used for this virus. The 2009 pandemic H1N1 virus is composed of (a) PB2 and PA segments from North American avian viruses; (b) the PB1 segment of the human H3N2 viruses; (c) hemagglutinin (HA; of the H1 subtype), nucleoprotein (NP) and NS segments derived from classical swine H1N1 viruses, and the neuraminidase (NA; of the N1 subtype), and (d) M segments of Eurasian “avian-like” swine viruses. Unlike previous strains of influenza virus, the novel swine origin influenza virus did not have a predilection for populations more than 60 years of age. Rather, more number of younger people less than 40 years of age were found to be affected. A small percentage of those affected were found to develop pneumonia or acute respiratory distress syndrome. The number of cases decreased greatly by May 2010, and the pandemic was officially declared to be at an end in August 2010. For diagnosis of H1N1 influenza, testing of samples like nasopharyngeal swabs or oropharyngeal swabs is essential. Real time RT-PCR for viral nucleic acid is the recommended method for its diagnosis, and other rapid tests like antigen detection were not found to be useful.

The treatment for severe cases of H1N1 influenza is the neuraminidase inhibitor, oseltamivir.

Two types of influenza vaccines have been developed against H1N1 influenza—a trivalent inactivated vaccine and a live attenuated influenza vaccine, which can be administered intranasally.

## Laboratory Diagnosis

During an epidemic of influenza, the clinical diagnosis can be made, but definitive diagnosis depends on the laboratory methods.

### ► Specimens

Specimens include nasal or throat washings or sputum for viral antigen and viral RNA, throat gargles for isolation of viruses, and serum for viral antibodies.

### ► Direct antigen detection

A rapid, specific diagnosis of influenza is made by demonstrating viral antigens directly on cells obtained from the nasopharynx. Immunofluorescence (IF) or enzyme-linked immunosorbent assay using specific monoclonal antibodies are used commercially to detect viral antigen. The results of the rapid tests are useful to start treatment with the NA inhibitors within 48 hours of the onset of symptoms.

### ► Isolation of the virus

Throat gargles are the specimen of choice. The specimen is collected in saline broth or a buffered salt solution and is sent immediately to the laboratory, or if delayed is stored at  $-4^{\circ}\text{C}$ . The virus is isolated from the specimen by inoculation into embryonated eggs or into certain cell cultures.

**Egg inoculation:** The specimen is inoculated into the amniotic cavity of the chick embryo. After incubation at  $35^{\circ}\text{C}$  for 3 days, the amniotic fluid and allantoic fluid are harvested and tested for the presence of viral HA. This is carried out by using fowl and guinea pig red cells in parallel and incubating at room temperature and at  $4^{\circ}\text{C}$ . Usually, influenza A viruses agglutinate only guinea pig cells, influenza B both fowl and guinea pig red cells, and influenza C agglutinate only fowl cells at  $4^{\circ}\text{C}$ . If the test is positive, the isolate is then typed by a serological test (e.g., hemagglutination inhibition test) using specific antisera to types A, B, and C.

**Cell culture:** Influenza virus is usually isolated from respiratory secretions by growing in tissue cultures (monkey kidney or baboon kidney cell lines). The cell cultures are incubated at  $33^{\circ}\text{C}$  in the roller drums in the presence of trypsin, but without serum.

Virus growth in tissue cultures is detected by direct demonstration of viral antigen in infected cell cultures by IF or by testing for hemadsorption with human O, fowl, and guinea pig red cells. In a positive hemadsorption test, red cells adhere to the virus budding from infected cells. If the culture tests positive, serological tests with specific antisera may be used to identify the virus.

### ► Serodiagnosis

Demonstration of a rise in serum antibody titer between acute-phase and convalescent-phase sera by a serological test is diagnostic of infection. The acute-phase sera are collected within a few days of illness and the convalescent sera 7–10 days after the illness. Complement fixation tests (CFTs) with RNP antigens of influenza types A, B, and C and also the CFTs with V antigens are employed for demonstration of rising antibody titer in the paired sera samples.

Hemagglutination inhibition test, enzyme neutralization test, radial immunodiffusion test, and ELISA are the other tests also used for demonstration of antibodies. However, none of these techniques are useful to identify all infections. Various approaches followed for laboratory diagnosis of influenza are summarized in Table 61-6.



### Molecular Diagnosis

Reverse transcriptase-polymerase chain reaction is used recently for the detection of viral nucleic acid in the nasopharyngeal cells for diagnosis of influenza.

## Treatment

Amantadine and rimantadine are the specific antiviral agents available for treatment of influenza. These drugs are effective against influenza A virus but not against influenza B virus.

TABLE 61-6

Laboratory diagnosis of influenza virus infection

Method	Test	Detection
Direct antigen detection	IF, ELISA	Influenza virus antigen in respiratory secretions
<b>Virus isolation</b>		
Cell culture	Primary monkey kidney cell, Madin-Darby canine kidney cell, and hemadsorption to infected cells	Limited cytopathic effects Presence of HA protein on cell surface
Chick embryo	Allantoic and amniotic cavity	Fluid is tested for hemagglutination of virus
Serology	Hemagglutination inhibition, Hemadsorption inhibition, ELISA, CFT, and IF	Demonstration of a rise in serum antibody titer
Molecular diagnosis	RT-PCR	Viral nucleic acid in the nasopharyngeal cells

ELISA, enzyme-linked immunosorbent assay; CFT, complement fixation test; IF, immunofluorescence; RT-PCR, reverse transcriptase-polymerase chain reaction.

These drugs when given within 1–2 days of the onset of illness, reduce severity of the disease and also hasten the disappearance of fever and other symptoms. The drugs are recommended for prevention of influenza in elderly unimmunized population in whom the influenza can cause a life-threatening infection. Emergence of viral resistance can occur during treatment.

Zanamivir (*Relenza*) and oseltamivir (*Tamiflu*) are newer drugs for treatment of influenza and are effective against both influenza A and B viruses. These are the NA inhibitors, which act by inhibiting the release of viruses from infected cells. These drugs also prevent the spread of virus from one cell to another. *Relenza* is used in the form of nasal spray, whereas *Tamiflu* is given orally.

## Prevention and Control

This is based on the following:

1. Immunoprophylaxis by vaccines
2. Chemoprophylaxis

### Immunoprophylaxis by vaccines

Influenza A subtypes H1N1 and H3N2 are most common prevailing human influenza viruses. The trivalent vaccine used worldwide contains influenza A strains from H1N1 and H3N2, along with an influenza B strain. Influenza virus vaccines have been used for about 40 years to prevent influenza, primarily influenza A and B. Following types of vaccines are used:

**Inactivated vaccines:** Initially inactivated vaccines were used. The viruses for these vaccines are grown in chick embryos, inactivated by formalin, purified to some extent, and adjusted to a dosage known to elicit an antibody response in most individuals. The vaccines contain the strains of types A and B viruses that are believed most likely to produce epidemics during the following winter.

The vaccine is administered parenterally. One or two doses are required, depending on the immune experience of the population with related antigens. The vaccines are recommended especially for persons at high risk, especially those over 65 years of age and those with chronic cardiopulmonary diseases.

Local and systemic reactions to the vaccine are minor and occur in the first day or two after vaccination. In some persons, the vaccine may cause reactions allergic to egg proteins present in the vaccine. The killed vaccines do not induce formation of secretory antibodies in the secretory mucosa, although they elicit production of specific protective antibodies in the serum.

**Live attenuated vaccines:** Live attenuated vaccines are now being developed as alternatives to inactivated vaccines. These vaccines induce production of specific secretory antibodies in respiratory mucosa. Earlier, the live vaccine used the viruses that were attenuated by repeated egg passage and was given by intranasal instillation. But these vaccines often failed to protect the children from clinical disease. Recently, temperature-sensitive (*ts*) mutant strains have been used in the live attenuated vaccine preparations. These avirulent mutants are able to grow at 32–34°C in the nasopharyngeal secretions, but not at 37°C in the lungs. These vaccines are useful to protect the children from clinical disease.

Table 61-7 summarizes vaccines available against influenza virus.

## Vaccines

**Recombinant vaccines:** Recombinant vaccines using recombinant strains are now being evaluated in influenza. Recombinant strains are produced by hybridization between the *ts* mutants and new antigenic variants of the strains. These strains carry the surface antigens of the new variants and growth properties of the old established strains. The recombinant vaccines are indicated most importantly for immunoprophylaxis of a new strain of influenza virus, threatening to cause pandemics of influenza.

### Chemoprophylaxis

Chemoprophylaxis by amantadine and rimantadine hydrochloride has been shown to be more successful. These two drugs effectively prevent infection and illness caused by type A, but not by type B viruses (because they lack M2 components). The persons with high risk can be protected by administering in a



**TABLE 61-7** Types of vaccines available against influenza virus

Type of vaccine	Advantage	Disadvantage
<b>Whole virus vaccines</b>	This vaccine confers protection in 60–90% of vaccines and the protection lasts for 1–5 years	The subsequent infecting virus may show slow antigenic drift and the vaccine-induced antibody will be less effective in conferring protection against the new strains
<b>Split virus vaccines</b>	These vaccines have been shown to induce fewer side effects in the vaccines	Just as immunogenic as whole virus vaccine
<b>Subunit virus vaccines</b>	Fewer reactions than those if given whole virus vaccines and absorbed subunit vaccine; therefore, the best vaccines available at present are the aqueous subunit vaccines	No significant disadvantage
<b>Live attenuated vaccines</b>	Immunization with live attenuated influenza virus vaccines induces a solid immunity than do inactivated vaccines. When given intranasally, few side effects are produced	No significant disadvantage

dosage of 100 mg/day. The drugs interfere with virus uncoating and transport by blocking the transmembrane M2 ion channel. These antiviral agents prevent about 50% of infections and about 67% of illnesses under natural conditions. When

administered for 10 days to household contacts of a person with influenza, these drugs protect up to 80% of the persons from illness. Side effects are greater for amantadine but are limited to the central nervous system.

 **CASE STUDY**

There was a scare of bird flu infections in poultry birds in Maharashtra during 2006. Newspapers reported that thousands of poultry birds were culled and poultry industry suffered a major economic loss due to that. People stopped taking chicken and chicken products.

- What was the reason for such scare among poultry industry?
- Which influenza virus causes infection in poultry birds and can it be transmitted to humans?
- Describe the possibility of genetic reassortment among bird flu and human influenza viruses.
- What are the prophylactic measures against the influenza virus in humans?

# Paramyxoviruses

## Introduction

Paramyxoviruses are roughly spherical-shaped viruses and usually vary in size from 100 to 300 nm. Sometimes, long filaments and giant forms of the virus measuring up to 800 nm are also found. These viruses consist of a negative-sense single-stranded RNA genome enclosed in a helical nucleocapsid surrounded by a pleomorphic envelope. Paramyxoviruses resemble orthomyxoviruses in morphology but are larger, surface spikes are different, and their genomes are not segmented (see Table 62-1).

## Classification

The family Paramyxoviridae consists of three important genera (*Morbillivirus*, *Paramyxovirus*, and *Pneumovirus*), which contain important human pathogens responsible for causing most of acute respiratory infections and contagious diseases of children and infants.

TABLE 62-1

### Diseases associated with paramyxoviruses

Virus	Diseases
Measles virus	Measles, atypical measles, and subacute sclerosing panencephalitis
Human parainfluenza virus (HPIV):	
HPIV-1, HPIV-2, and HPIV-3	Croup
HPIV-1 and HPIV-3	Pneumonia
HPIV-1, HPIV-2, HPIV-3, and HPIV-4	Bronchiolitis and tracheobronchitis; other infections: otitis media, pharyngitis, conjunctivitis, and coryza
Mumps virus	Mumps
Respiratory syncytial virus	Upper respiratory tract infection, common cold; lower respiratory tract illness, resulting in bronchiolitis or pneumonia in infants
Nipah virus	Encephalitis
Hendra virus	Zoonotic paramyxovirus Severe respiratory disease and respiratory tract disease in children and adults
Human metapneumovirus	Respiratory pathogen first detected using a molecular approach

- The genus *Morbillivirus* includes the measles virus.
- The genus *Paramyxovirus* includes parainfluenza and mumps virus.
- The genus *Pneumovirus* includes respiratory syncytial virus (RSV), which is responsible for majority of acute respiratory infections in infants and children.

The nucleocapsid is associated with the nucleoprotein (NP), polymerase phosphoprotein (P), and larger (L) protein. The NP maintains genomic structure, the P facilitates RNA synthesis, and the L protein is an RNA polymerase. The nucleocapsid surrounded by envelope has the matrix (M) protein at its base. The virion envelope contains two glycoproteins, a fusion (F) protein and a viral attachment protein called hemagglutinin neuraminidase (HN), hemagglutinin (H), or G protein. The F protein facilitates fusion of the viral and host cell membranes, and HN promotes adsorption of the virus to the host cell surface. The F protein is activated by proteolytic cleavage, resulting in the production of F1 and F2 glycopeptides held together by disulfide bond to express membrane-fusing activities.

The binding of the HN, H, or G protein on the virion envelope to these cell surface glycoproteins containing sialic acid is the first step in the replication of paramyxoviruses. This is followed by the fusion of the viral envelope with the plasma membrane of the cell, promoted by the F protein of the virion envelope. In addition, paramyxovirus also induces cell-to-cell fusion, resulting in production of multinucleated giant cells. Paramyxoviruses associated with human diseases are summarized in Table 62-1.

## Measles Virus

Measles is a highly communicable acute viral disease characterized by fever, conjunctivitis, and pathognomonic Koplik's spots. It is one of the five classic exanthematous diseases of the childhood; others being chickenpox, rubella, roseola, and fifth disease.

## General Properties

### ► Morphology

Measles virus shows following features:

- Measles virus is spherical, but is often pleomorphic, measuring 120–250 nm in diameter.
- It contains a negative-sense RNA genome.
- The helical nucleocapsid is surrounded by an envelope carrying H and F protein on its surface. The virus causes hemagglutination of monkey erythrocytes, but it is not followed by elution as the virus does not produce any neuraminidase activity.

### ► Viral replication

Measles virus replicates in the cell cytoplasm. The virus first adsorbs cell surface by its hemagglutinin, then enters the cell, and uncoats inside the cytoplasm of the cell. The viral RNA polymerase transcribes the negative-strand genome into mRNA. Multiple copies of mRNAs are produced, each of which is translated into specific viral proteins. This is followed by the assembly of nucleocapsid, and the virus is released by budding from the cell membrane.

### ► Antigenic and genomic properties

The measles virus has only one serotype and infects only humans, not any other mammals. The virus is antigenically uniform; it shares antigens with canine distemper virus.

### ► Other properties

The measles virus is heat labile. It is readily inactivated by ether, formaldehyde, high temperature, and ultraviolet light. The virus is stabilized by molar  $\text{MgSO}_4$  following which the virus resists heating at 50°C for 1 hour.

## Virus Isolation

### ► Culture

The measles virus is very difficult to grow, although it can be grown in primary human or monkey kidney cell cultures. The isolates can be adapted for growth on HeLa or Vero cell lines. Characteristic cytopathological effects include multinucleated giant cells with cytoplasmic and nuclear inclusion bodies. *Warthin–Finkeldey cells* are the multinucleated giant cells produced by measles virus in lymphoid tissue of the patients. These giant cells are produced as a result of the F proteins in the spikes.

## Pathogenesis and Immunity

Measles is highly contagious and is spread from person to person by aerosols. It enters the susceptible host by the respiratory route.

### ► Pathogenesis of measles

The virus initiates infection and replicates locally in the trachea and bronchial epithelial cells of the respiratory tract. After 2–4 days, the virus spreads systemically in lymphocytes, perhaps carried by pulmonary macrophages, and causes viremia. Wide

dissemination of the virus causes infection of the conjunctiva, respiratory tract, urinary tract, lymphatic system, blood vessels, and the central nervous system (CNS). The characteristic rash seen in measles is caused primarily by cytotoxic T cells attacking the measles virus-infected epithelial cells in the skin.

## Key Points

Encephalitis is one of the most important sequelae of the infection caused by measles. The virus causes:

- encephalitis by direct infection of the neurons;
- immune-mediated conditions, such as postinfectious measles encephalopathy, believed to be immune mediated; and
- subacute sclerosing panencephalitis (SSPE) caused by an infective mutant of measles, produced during the acute stage of the disease.

### ► Host immunity

Measles causes immunosuppression, characterized by decrease in eosinophils and lymphocytes (both B and T cells) and depression of their response to activation by mitogens. Also, the condition is associated with marked decrease in interleukin-12 production and leads to antigen-specific lymphoproliferative responses that are present for weeks to months after the acute infection.

Cell-mediated immunity (CMI) plays an important role to control measles infection. Therefore, measles virus in individuals with deficiency in cellular immunity causes progressive and often fatal giant cell pneumonia without a rash. The antibodies do not have any role in conferring protection against measles virus, because the viruses spread from cell to cell. However, maternal antibodies in infants protect against measles during first 6 months of life.

Immunosuppression caused by measles in the infected individuals may predispose individuals to bronchopneumonia, a severe bacterial infection and a major cause of measles-related mortality among young children. Nevertheless, one attack of measles confers lifelong immunity.

## Clinical Syndromes

Measles virus is associated with the following clinical syndromes: (a) measles, (b) atypical measles, and (c) subacute sclerosing panencephalitis.

### ► Measles

Incubation period varies from 8 to 12 days. Measles is a highly contagious febrile illness. The prodromal phase is characterized by high fever, malaise, anorexia, conjunctivitis, cough, and coryza. Koplik's spot is the typical pathogenic lesion found in the mucous membrane.

**Koplik's spots:** These are bluish gray specks or grain substance on a red base, which usually appear on the buccal mucosa opposite the second molar. They appear at the end of

prodrome, just before the appearance of rash. These Koplik's spots may also appear on the mucous membrane of the conjunctiva and vagina. Koplik's spots usually appear after 2 days of illness. These spots, which last for 24–48 hours, are pathognomonic of measles. Their presence establishes the diagnosis of measles.

An erythematous maculopapular rash appears within 12–24 hours of appearance of the Koplik's spots. The rash usually begins on the face, then spreads extensively and appears on the trunk, extremities, palms, and soles and lasts for about 5 days. Desquamation of the rashes except those of palms and soles may occur after 1 week. Patients appear highly sick during the first or second day of the appearance of the rash. The rash is typically absent in patients with defective CMI. Generalized lymphadenopathy and mild hepatomegaly may also occur in some patients.

**Complications of measles:** Complications include otitis media, bronchopneumonia, laryngotracheobronchitis (*croup*), and diarrhea. Bronchopneumonia is a most serious condition and is responsible for 60% of deaths caused by measles virus. Hepatitis, encephalitis, and SSPE are the rare complications. Encephalitis is one of the most dangerous complications and occurs approximately in one of every 1000 patients. Measles causes death mostly in children younger than 5 years. It causes high mortality in (i) infants between 4 and 12 months and (ii) children who are immunocompromised because of human immunodeficiency virus (HIV) infection or other diseases.

### ► Atypical measles

Atypical measles is a syndrome that has been described in people who were infected with measles virus after immunization with the older, killed measles vaccine used during 1963–1977. This condition also occurs, but rarely, in individuals vaccinated with attenuated virus vaccine. The condition is characterized by a prolonged high fever, pneumonitis, and the rash. The rash characteristically begins peripherally and may be urticarial, maculopapular, hemorrhagic, or vesicular. The condition appears to be immune mediated and to occur as a result of hypersensitivity to measles virus in a partially immune host. This condition is associated with a low measles antibody titer early in the course of infection but a very high measles IgG antibody titer during the course of infection (e.g., 1:1,000,000).

### ► Subacute sclerosing panencephalitis

The subacute sclerosing panencephalitis (SSPE) is a degenerative disease of the CNS caused by persistent measles infection. It is the most serious and late neurological sequelae of measles that affects the CNS. The disease is characterized by the development of behavioral and intellectual deterioration and seizures after many years (mean incubation period is 10.8 years) of infection by measles.

The condition occurs in about seven in every 1 million patients. The condition occurs most commonly in children who were initially affected when they were younger than 2 years. The condition is associated with the presence of an extremely high measles antibody titer in the blood and cerebrospinal fluid (CSF).

## Epidemiology

Measles is a disease reported throughout the world.

### ► Geographical distribution

Epidemics of measles occur every 2–3 years. Approximately, 30 million cases of measles are reported annually, most cases being from Africa. The condition has also been well documented in the America, Europe, Eastern Mediterranean region, Western Pacific region, and Southeast Asia.

### ► Reservoir, source, and transmission of infection

Measles is exclusively a human disease. Infected respiratory droplets are the primary source of infection. Patients are infectious from 3 days before the onset of illness until the rash desquamates. Infectivity is maximum at the prodrome and diminishes rapidly with the onset of the rash. The infection is transmitted from person to person by inhalation of large droplet aerosols produced during the act of coughing and sneezing.

Children with immunodeficiency due to leukemia, corticosteroid therapy, or HIV are at increased risk for infection regardless of their status of immunization. Unvaccinated people are also at risk. The condition is most commonly seen in children living in crowded condition.

## Laboratory Diagnosis

The clinical manifestations of typical measles cases are so characteristic that the diagnosis is self-evident. The laboratory diagnosis is frequently helpful to diagnose atypical measles and to differentiate from rubella.

### ► Specimens

Respiratory specimens, conjunctival specimens, urine, blood, and brain tissues are the frequently used specimens. The respiratory specimens and blood collected during the prodromal stage and the period following until 2 days after the appearance of the rash are the specimens of choice for isolation of viruses by culture.

### ► Microscopy

Demonstration of multinucleated giant cells, measuring up to 100 nm in diameter, in Giemsa-stained smears is diagnostic of measles (Fig. 62-1, Color Photo 58). These giant cells can be demonstrated in biopsies of Koplik's spots, nasal secretion smears, and in dermal rashes.

### ► Direct antigen detection

Measles antigen can be detected in nasal secretions, pharyngeal secretions, or in urinary sediments by direct immunofluorescence antibody test.

### ► Isolation of the virus

The measles virus is difficult to isolate, but it can be grown in primary human or monkey kidney cell cultures. The virus produces cytopathic effects (CPEs) very slowly, usually 1 week after

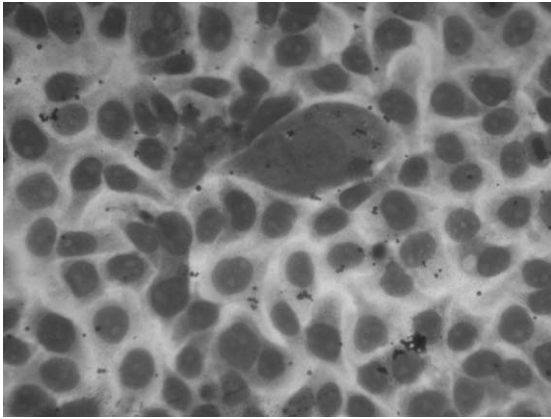

**FIG. 62-1.** Multinucleated giant cells of measles in Giemsa-stained smears ( $\times 1000$ ).

inoculation. The viral antigen appearing in the infected cell cultures, however, can be detected much earlier by using direct immunofluorescence antibody test.

### ► Serodiagnosis

Sandwich capture IgM enzyme-linked immunosorbent assay (IgM ELISA) is the quickest method to diagnose acute measles by detection of IgM antibodies in the serum. The IgM antibodies begin to appear in the serum on the third day after appearance of rash and remain positive 30–60 days after illness in most individuals suffering from measles. The test is therefore positive during these days. IgM ELISA is highly sensitive (nearly 100%) during this period of illness. The IgM antibody is usually not positive in the first 2 days after appearance of rash; in some individuals, IgM antibodies may become negative 30 days after the onset of rash.

Demonstration of more than fourfold rise in IgG antibody titer between acute and convalescent sera confirms diagnosis of measles. IgG antibodies usually appear 4 days after the onset of rash and persist for a longer period even after the patient has been cured of the illness. Demonstration of unusually high titer of measles antibody in the serum and CSF is diagnostic of SSPE.

### Treatment

Ribavirin given either intravenous or in aerosol form is being now evaluated to treat severely affected adults and immunocompromised individuals with acute measles or SSPE. Measles virus has been shown to be susceptible to ribavirin *in vitro*. However, the drug is yet to be used for regular treatment of cases of measles, since no controlled trials have been conducted to test the efficacy of the drug in patients with measles.

### Prevention and Control

Measles vaccine along with mumps and rubella (MMR) vaccine is currently used for universal immunization of children.

Serum human gamma globulin, if administered within 6 days of exposure to measles, may prevent or attenuate the

disease. This is of immense value in children with immunodeficiency, in pregnant women, and in others at increased risk to measles.

### Vaccines

- Measles vaccine is a live attenuated vaccine, which now uses Schwartz and Moraten attenuated strain of the original Edmonston B strain.
- The first dose of vaccine is given to children older than 12 months in the United States, but are used for children aged 9 months in developing countries like India with high endemicity.
- The second dose of the vaccine is given usually to school-going children aged 4–6 years.
- Immunization with two doses of vaccine has shown a sero-conversion of 99% after 1 year.

### Parainfluenza Virus

Human parainfluenza viruses (HPIVs) are the pathogens that primarily affect young children; in whom the viruses cause upper and lower respiratory tract infections. The nomenclature and taxonomic relationship of HPIVs have changed considerably over the last decade. These are now composed of five serotypes: HPIV-1, HPIV-2, HPIV-3, HPIV-4a, and HPIV-4b. They belong to two different genera: the genus *Respirovirus* (HPIV-1, HPIV-3) and the genus *Rubulavirus* (HPIV-2, HPIV-4a, and HPIV-4b).

### Properties of the Virus

#### ► Morphology

Human parainfluenza viruses (HPIVs) show following features:

- HPIVs are pleomorphic viruses measuring 150–200 nm in diameter.
- The virus contains a single-stranded, nonsegmented, negative-sense RNA genome with nucleoproteins P and L. It is surrounded by a helical nucleocapsid, which contains glycoprotein spikes.
- The surface spikes consist of H, N (neuraminidase), and F proteins. Both H and N proteins are present on the same spike, whereas the F protein is present on a separate spike. The F protein mediates the formation of multinucleated giant cell.

#### ► Viral replication

Viral replication of the parainfluenza viruses is similar to that of measles virus.

#### ► Antigenic and genomic properties

The virus contains five serotypes: HPIV-1, HPIV-2, HPIV-3, HPIV-4a, and HPIV-4b. These serotypes show cross-reactions among themselves.

## Virus Isolation and Animal Susceptibility

### ▶ Cell culture

Human parainfluenza viruses grow in primary monkey kidney (PMK) cells (Rhesus and African green monkeys). The virus also grows in continuous monkey kidney cell lines (LLC-MK2), which is excellent for continuous passage and almost as good as PMK cells for primary isolation.

## Pathogenesis and Immunity

Human parainfluenza virus infection is limited to respiratory tract. Respiratory epithelium appears to be the important site of virus binding and subsequent infection.

### ▶ Pathogenesis of human parainfluenza virus infection

The virus adsorbs to the respiratory epithelial cells by specifically combining with neuraminic acid receptors in the cell through its hemagglutinin. Subsequently, the virus enters the cells following fusion with the cell membrane, mediated by F1 and F2 receptors. The virus replicates more rapidly than mumps and measles viruses in the cell cytoplasm and causes formation of multinucleated giant cells. These giant cells, each of which contains two to seven nuclei, usually develop late in the infection. The virus also causes the formation of single and multilocular cytoplasmic vacuoles and basophilic or eosinophilic inclusions.

The virus causes inflammation of the respiratory tract, leading to secretions of high level of inflammatory cytokines, usually 7–10 days after initial exposure. Airways inflammation, necrosis, and sloughing of respiratory epithelium, edema, and excessive mucus production are the noted pathological features associated with HPIV infections.

### ▶ Host immunity

Humoral immunity plays a major role in defense against HPIVs. The antibodies are produced against both surface glycoproteins (HN and F) of the virus. Neutralizing antibodies to all the five types of the viruses are seen in most of the children at the time of birth; but the titer falls rapidly after 6 months. Most children and adults develop detectable level of neutralizing antibodies in the serum following natural infection with the virus.

Secretory IgA antibodies also appear to play an important role. The CMI appears to play some role in containing the disease, as HPIV infection tends to be more severe in persons with defective CMI.

Immunity to HPIV is long-lasting, but reinfection may occur many times throughout the life, most probably due to the presence of multiple serotypes of HPIV.

## Clinical Syndromes

Human parainfluenza viruses cause croup, pneumonia, bronchiolitis and tracheobronchitis, and some other infections.

### ▶ Croup

Croup or laryngotracheobronchitis is a heterogeneous group of illnesses that affects the larynx, trachea, and bronchi. The condition manifests as fever, cough, laryngeal obstruction, and expiratory stridor. HPIV-1, HPIV-2, and HPIV-3 are the common causes of croup; of which HPIV-1 is the most common.

### ▶ Pneumonia

HPIV-1 and HPIV-3 are responsible for most cases of human parainfluenza pneumonia. Fever, rales, and evidence of pulmonary consolidation are the common symptoms.

### ▶ Bronchiolitis and tracheobronchitis

Bronchiolitis is caused by all the five types of HPIV, but HPIV-1 and HPIV-3 are the most common causes. Most cases of bronchiolitis occur in infants. The condition manifests as fever, expiratory wheezing, tachypnea, and rales. HPIV-3 is more commonly associated with tracheobronchitis than HPIV-1 or HPIV-2.

### ▶ Other infections

Otitis media, pharyngitis, conjunctivitis, and coryza are the other infections caused by HPIV.

## Epidemiology

Human parainfluenza viruses are ubiquitous.

### ▶ Geographical distribution

HPIVs (HPIV-1, HPIV-2, HPIV-3, and HPIV-4) have worldwide distribution. HPIV-1 is usually associated with epidemics of the disease.

### ▶ Reservoir, source, and transmission of infection

Parainfluenza viruses cause disease exclusively in humans. No animal reservoirs are present. Respiratory secretions from the infected humans are the source of infection. The infection is transmitted by inhalation of respiratory droplets or by direct person-to-person contact with infected secretions.

### Key Points

- HPIV-1 causes the largest, most common outbreaks of parainfluenza virus infections.
- Outbreaks of infection with HPIV-2 usually follow HPIV-1 infection.
- HPIV-3 infections cause outbreaks mainly in spring and summer.
- HPIV-4 is infrequently isolated.

## Laboratory Diagnosis

### ▶ Specimens

Respiratory specimens include nasopharyngeal aspirations, nasal washings, and nasal aspirations.

### ► Direct antigen detection

The ELISA, immunofluorescence assay, and fluoroimmunoassays are used to detect HPIV antigen directly in urine specimens. These methods are sensitive and specific. Shell viral assay is a sensitive method for rapid demonstration of the virus.

### ► Isolation of the virus

**Cell culture:** The virus can be isolated from clinical specimens by culture in PMK and LLC-MK2 cell lines. The CPEs are rarely demonstrated during primary isolation of the virus in tissue culture with exception of HPIV-2. The latter causes formation of syncytium in the infected cells. Hemadsorption inhibition using guinea pig erythrocytes is also used for detection of virus antigen in cell lines within 3–10 days of incubation.

### ► Serodiagnosis

Hemagglutination inhibition, neutralization, ELISA, and Western blot are frequently used antibody-based serological tests for diagnosis of HPIV infection. A fourfold rise in antibody titer of acute and convalescent sera is diagnostic of acute infection.



### Molecular Diagnosis

A multiplex reverse transcriptase polymerase chain reaction (RT-PCR) has been developed for simultaneous detection of HPIV-1, HPIV-2, and HPIV-3 genome in clinical specimens.

### Treatment

Ribavirin has been shown to be effective against HPIV infection *in vitro*. Uses of ribavirin aerosols or systemic therapy for treatment of HPIV infection in children and adults who are severely immunocompromised have shown mixed results with uncertain clinical benefit.

### Prevention and Control

Live attenuated vaccine is available. Field trials of formalin-killed whole HPIV (HPIV-1, HPIV-2, and HPIV-3) have proved to be ineffective in children. These vaccines failed to protect against natural infection by parainfluenza virus.

### Mumps Virus

Mumps is an acute infectious disease of children, characterized by acute, nonsuppurative, painful swelling of the salivary glands, caused by mumps virus.

### Properties of the Virus

#### ► Morphology

Mumps virus shows following features:

- Mumps virus is a typical paramyxovirus containing a single-stranded, negative-sense RNA surrounded by an envelope.
- It has two major surface glycoproteins: (a) one with both hemagglutinin and neuraminidase and (b) the other with cell-fusion protein.
- The hemagglutinin agglutinates the RBCs of fowl, guinea pigs, humans, and many other species. The hemagglutination is followed by hemolysis and elution at 37°C.
- The F protein is responsible for fusion of lipid membrane of the virus to the host cell.

#### ► Viral replication

Viral replication is similar to that of measles virus.

#### ► Antigenic and genomic properties

Only one antigenic type of mumps virus is known. Neutralizing antibodies are produced against the hemagglutinin. It has an internal nucleocapsid soluble (S) antigen, which is detected by the complement fixation test.

#### ► Other properties

The mumps virus is a heat-labile virus. It is sensitive to heat and rapidly inactivated at room temperature. Treatment with formaldehyde, ether, or ultraviolet light also inactivates the virus. The virus can be stored for a longer period by lyophilization at –70°C.

### Virus Isolation

#### ► Cell culture

The virus grows well in PMK tissue culture, Hep-2 cells, and H292 cells. The CPE consists of multinucleated giant cells and acidophilic cytoplasmic inclusions. The growth of virus in the cells can be detected by direct immunofluorescence and hemadsorption. The virus also grows well in amniotic cavity of 6–8 days' old embryonated egg.

### Pathogenesis and Immunity

#### ► Pathogenesis of mumps

Infection by mumps virus begins after the entry of the virus into the respiratory tract. The virus then replicates locally and disseminates by blood circulation to target tissues, such as the CNS and salivary glands, particularly the parotid glands. The virus causes infection of the parotid gland either through Stensen's duct or by viremia. Salivary glands, such as parotid glands, show desquamation of necrotic epithelial cells lining the ducts.

The virus replicates in these target tissues and then causes a secondary phase of viremia. The virus is spread by viremia throughout the body to kidneys, testes, ovary, pancreas, and other organs. Infection of the CNS, especially meninges, causes meningitis, or meningoencephalitis (Fig. 62-2).

## ► Host immunity

Humoral immunity is characterized by the appearance of antibody against the soluble S antigen and hemagglutinating antibodies. The antibody against S antigen is the first to appear, within 3–7 days after the onset of symptoms. The hemagglutinating antibodies directed against hemagglutinin confer lifelong immunity against mumps virus. CMI is essential for control of infection. This also contributes to pathogenesis of the disease and is responsible partially for the symptoms observed during the course of clinical illness. Immunity in mumps is lifelong.

## Clinical Syndrome

Mumps virus causes mumps.

## ► Mumps

The incubation period is long and varies from 12 to 25 days. Most of the infections are asymptomatic. The onset of mumps is sudden.

### Key Points

- Fever, headache, and earache are the initial symptoms. These symptoms are followed by painful swelling of the parotid gland. Initially, it may be unilateral but may become bilateral later. The condition is accompanied by fever, local pain, and tenderness.
- Epididymo-orchitis is the second most common manifestation in adults, which is usually preceded by parotitis. Orchitis may occasionally cause testicular atrophy and sterility.

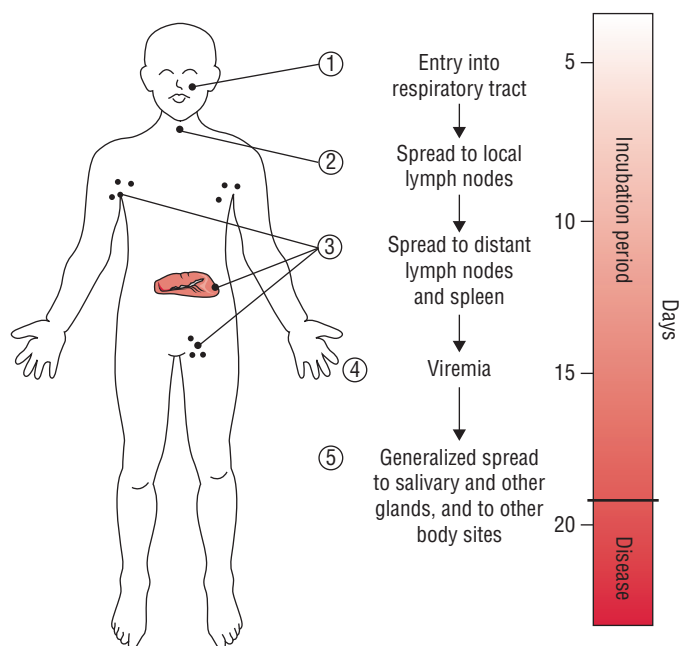

FIG. 62-2. Pathogenesis of mumps.

**Complications of mumps:** Meningoencephalitis is the most frequent complication of mumps in childhood. Other rare complications include oophoritis, mastitis, pancreatitis, thyroiditis, arteritis, thrombocytopenia, and pneumonia. Death due to mumps is rare.

## Epidemiology

Mumps is a highly communicable disease, occurring worldwide.

## ► Geographical distribution

Mumps continues to remain endemic in many countries throughout the world, as the mumps vaccine is used in only 57% of the countries. In the absence of vaccination program, it often occurs as epidemics in children 5–15 years of age.

## ► Reservoir, source, and transmission of infection

Humans are the only natural hosts of the mumps virus. No animal hosts are present. The infected patients are the source of infection. A patient remains infectious usually from 9 days prior to the onset of parotid swelling as long as 7 days after onset of the swelling. The infection is transmitted by direct person-to-person contact and also by inhalation of respiratory droplets. The unvaccinated people and immunocompromised people are at more risk to infection by mumps virus.

## Laboratory Diagnosis

Diagnosis of mumps is usually clinical. The laboratory diagnosis is useful for diagnosis of atypical infection or manifestation of mumps without typical symptoms.

## ► Specimens

The specimens include the saliva, urine, secretions from Stensen's duct, and the CSF. The virus is present in the saliva for 4–5 days, in the CSF for 8–9 days, and in the urine for 15 days after the onset of the symptoms.

## ► Isolation of the virus

**Egg inoculation:** Egg inoculation is another method, but is a less sensitive method than the cell culture. The viruses can be detected in the amniotic fluid, after inoculating 6–8 days' old embryonated egg. The virus is identified in amniotic fluid 5–6 days after inoculation by hemagglutinin inhibition assay for hemagglutinins.

**Cell culture:** Mumps virus can be isolated from clinical specimens by inoculation into monkey kidney cells, human amnion cells, or HeLa cells. The growth of the virus in monkey kidney cells is detected by the presence of multinucleated giant cells. The CPE may take as long as 1–2 weeks to appear. Virus growth in the cells can be detected much earlier by hemadsorption of guinea pig erythrocytes adsorbing the surface of virus-infected cells. Immunofluorescence test is also a very rapid test used to



detect viral antigen in the infected cells as early as 2–3 days after inoculation.

### ► Serodiagnosis

The hemagglutinin inhibition, immunofluorescence assay, and ELISA are used for demonstration of viral antibodies in the serum. Detection of mumps-specific IgM antibody by IgM ELISA indicates recent and active infection. A fourfold increase between acute and convalescent phases in serum IgM antibody levels confirms the diagnosis of mumps.

### Treatment

No specific antiviral agents are available against mumps.

### Prevention and Control

To achieve and maintain high immunization levels, primarily in infants and young children, is the principal strategy to prevent mumps.

### Vaccines

An effective live attenuated vaccine is available against mumps. The vaccine consists of the Jeryl-Lynn strain of mumps virus attenuated by serial passage in eggs and chick fibroblasts. The vaccine confers 95% protection, which lasts for as long as 12 years.

The vaccine is recommended for use in children of both sexes, at 12 months of age. The vaccine can be given to all asymptomatic HIV-infected children at the same age. It is given as a part of MMR vaccine. The vaccine is contraindicated in pregnancy and in patients with severe febrile illness.

### Respiratory Syncytial Virus

Respiratory syncytial virus (RSV) is the leading cause of respiratory tract infection in infants and young children.

### Properties of the Virus

#### ► Morphology

Respiratory syncytial virus shows following features:

- It is pleomorphic and measures from 150 to 300 nm in size.
- It has a small nucleocapsid, measuring 13 nm in diameter, unlike large nucleocapsid (18 nm) of other paramyxoviruses.
- The viral envelope contains a surface glycoprotein G, by which it is attached to the cell surface of the host cells. It contains F protein but lacks both H and N proteins.
- The F protein induces the fusion of the infected cells with adjoining cells, resulting in the formation of large multinucleated syncytia, from which the virus derives its name.

Differences between morphology of RSV and other paramyxoviruses are summarized in Table 61-1.

#### ► Viral replication

Viral replication is similar to that of measles virus.

#### ► Antigenic and genomic properties

The virus is antigenically stable. It has only one antigenic serotype with the subtypes A and B. Subtype A appears to be more virulent than the subtype B.

#### ► Other properties

The virus is highly labile; it is easily inactivated by dryness at room temperature and by acid. It is preserved by lyophilization.

### Virus Isolation

#### ► Cell culture

Respiratory syncytial virus is difficult to grow in cell culture in PMK or in human cell (HeLa cells, Hep-2) lines. Formation of large multinucleated syncytia is the characteristic CPE produced by the virus, but slowly in 2–10 days.

### Pathogenesis and Immunity

Respiratory syncytial virus infection is restricted to the respiratory tract. The virus initiates infection in the epithelial cells of the upper respiratory tract. Spread of the virus down the respiratory tract occurs by cell-to-cell transfer of the virus along the syncytia from the upper respiratory tract to the lower respiratory tract, resulting in pneumonia. The virus usually does not cause any viremia or systemic spread. The virus causes necrosis of the small airway epithelium, plugging of the lumens with exudates, and edema, leading to obstruction of the normal airways of the young infants. The host's immune response plays a major role in the pathogenesis of bronchiolitis observed during the period of illness.

#### ► Host immunity

Humoral antibody plays a minimal role in the host immunity against RSV. Maternal antibodies do not protect the infant from infection. CMI appears to play an important role in recovery from infection. Natural infection by RSV does not prevent reinfection by the virus.

### Clinical Syndromes

Respiratory syncytial virus primarily causes infection of the respiratory tract, ranging from common cold to pneumonia.

#### ► Common cold

The illness begins with infection of the upper respiratory tract, which manifests as common cold with marked rhinorrhea (running nose). This condition is most common in older children and adults. Incubation period varies from 4 to 5 days.

#### ► Bronchiolitis

In infants, RSV causes a more severe lower respiratory tract illness, resulting in bronchiolitis or pneumonia. Clinically, the condition presents as cough, coryza, wheezing, rales, and

low-grade fever (<101°F). Bronchiolitis is usually self-limiting, but may cause a serious disease in premature infants, in immunocompromised hosts, and in individuals with underlying lung diseases. Reinfection with the virus occurs throughout the life. However, with advancing age and recurrent infection, the RSV infection is confined more to the upper respiratory tract than the lower respiratory tract.

## Epidemiology

### ► Geographical distribution

Respiratory syncytial virus infection is prevalent worldwide.

### ► Reservoir, source, and transmission of infection

Respiratory syncytial virus is highly contagious. Humans are the only hosts. Infected patients are the source of infection. They continue to excrete viruses for several days or weeks in their respiratory secretions. The infection is transmitted:

- usually by inhalation of large droplet aerosols, coughed out by the patient during the act of coughing or sneezing.
- also by direct contact with contaminated hands and fomites.

The virus is highly prevalent in young infants and children, with a peak incidence in 2–8 months' old infants. Virtually all children are infected by RSV by the age of 4 years. The viral infection is usually seasonal and mostly occurs during winter. Nosocomial infections caused by the virus are frequent in nurseries and pediatric ward.

## Laboratory Diagnosis

### ► Specimens

These include respiratory secretions obtained by washing, suctioning, or swabbing of the nasopharynx.

### ► Direct antigen detection

The viral antigens in the nasal washings or nasopharyngeal aspirates can be detected by using ELISA or direct immunofluorescence antibody test using specific monoclonal antibodies.

### ► Isolation of the virus

The virus can be isolated from clinical specimens by inoculation of HeLa cells, Hep-2 cells, or monkey kidney cells. After 2–10 days of incubation, RSV is identified by the characteristic syncytium formation in the cells. Direct immunofluorescence can also be used to detect viral antigen in infected cells.

### ► Serodiagnosis

The ELISA is used for demonstration of antibodies in the serum. Demonstration of a fourfold or more increase in the antibody titer of acute and convalescent sera confirms the diagnosis of RSV infection.

## Treatment

Ribavirin, a broad-spectrum antiviral agent, has been recommended for the aerosolized treatment of children with severe RSV disease. This has shown beneficial effect by decreasing the duration of illness and decreasing the shedding of viruses in respiratory secretions.

## Prevention and Control

Passive immunization with anti-RSV immunoglobulin has proved beneficial for use for prophylaxis in high-risk infants such as premature babies or babies with chronic lung disease. The anti-RSV immunoglobulin is a pooled polyclonal human immunoglobulin product with high titers of RSV antibodies.

Attempts to use a vaccine against RSV have been proved unsuccessful to date. Previously, a formalin-inactivated RSV vaccine was used in children, but the children who received this vaccine developed more severe disease than those who were exposed to natural RSV infection; hence, this vaccine is no longer used. Recently, a live attenuated RSV vaccine that can be used as nasal spray is under evaluation.

## Nipah Virus

Nipah virus was reported to be the causative agent of encephalitis in Malaysia and Singapore in 1998 and 1999. People rearing pig populations were increasingly susceptible to encephalitis to this previously unrecognized virus. No specific antiviral agent or vaccine is available against Nipah virus.

## Hendra Virus

Hendra virus is a recently described, new paramyxovirus. Hendra virus was first isolated from the cases of severe respiratory disease in Hendra, Australia, in 1994; hence the name Hendra virus. Infection is transmitted from infected horses to humans. Fruit bats are the natural reservoir. No specific antiviral agent or vaccine is available against Hendra virus.

## Human Metapneumovirus

Human metapneumovirus (HMPV) is a newly described virus in the family Paramyxoviridae. The virus was first reported as a cause of respiratory illness in children in 2001. The clinical manifestations of HMPV are closely similar to that of RSV infection in children. Human metapneumovirus like other members of the family Paramyxoviridae is a single-stranded RNA virus. The virus is a respiratory pathogen and is associated as the cause of respiratory tract disease in children and adults worldwide.

The virus appears to be prevalent worldwide. The first report of virus in 2001 demonstrated that all Dutch children by the

age of 10 years were seropositive for the virus. Similar studies conducted in Australia, Canada, Japan, and Israel have shown the high seroprevalence of HMPV antibodies in the population. Infants, elderly persons, and immunocompromised individuals appear to be more susceptible to infection by the virus.

The virus is an important cause of respiratory tract infection in children, particularly in infants. It causes a disease, clinical manifestations of which are very much similar to those caused by human RSV. It causes a clinical disease, which ranges from mild respiratory symptoms to severe cough, bronchiolitis, and pneumonia. The condition is also associated with high-grade fever, vomiting, and myalgia. The virus

also causes RSV-like diseases in adults, especially in those with chronic obstructive lung disease.

The virus is very difficult to grow in cell culture, and currently, serodiagnosis tests are not widely available for diagnosis of the condition. PCR appears to be the most specific test for diagnosis of the condition by examination of respiratory secretions. These include nasopharyngeal swabs, nasopharyngeal aspirates, or bronchoalveolar lavage specimens.

No specific antiviral treatment is available for HMPV infection. Hence, the treatment is majorly supportive. No vaccine is currently available for HMPV infection. Characteristics of various genera in the family Paramyxoviridae are summarized in Table 62-2.

TABLE 62-2

Characteristics of various genera in the family Paramyxoviridae

Virus	Serotypes	Membrane fusion	Hemolysin	Hemagglutination	Hemadsorption	Neuraminidase	Inclusions
Measles	1	+	+	+4	+	–	Nuclear, cytoplasmic
Mumps	1	+	+	+3	+	+3	Cytoplasmic
Parainfluenza	4	+	+	+3	+	+3	Cytoplasmic
Respiratory syncytial virus	2	+	–	–	–	–	Cytoplasmic
Human metapneumovirus	?	+	–	–	–	–	?
Hendra and Nipah virus	?	+	–	–	–	–	?

 CASE STUDY

A 3-year-old girl attended the Pediatrics OPD with complaints of high fever, malaise, anorexia, conjunctivitis, cough, and coryza. Parents of the child gave the history of appearance of red-colored rash initially on the face and then spreading to the trunk, extremities, palms, and soles. On examination, bluish gray specks on a red base were found on the buccal mucosa opposite the second molar.

- What is the clinical diagnosis of the condition?
- Are there any laboratory tests to confirm the diagnosis of the condition?
- Is the child contagious, and how is the virus transmitted?
- What are the vaccines available to prevent the condition?

# Reoviruses

## Introduction

The family Reoviridae is divided into nine genera, of which only four genera cause human diseases. These genera are *Orbivirus*, *Orthoreovirus*, *Rotavirus*, and *Coltivirus*. Other genera infect only the plants, insects, and fish. The Reoviridae viruses are non-enveloped viruses with double-layered protein capsids. The inner capsid layer shows well-defined subunits, whereas the outer layer of some viruses (e.g., rotaviruses and orbiviruses) lacks these well-defined structures. The genome consists of a 10–12-segmented double-stranded RNA with a total genome size of 16–27 kbp. The virus core contains many enzymes essential for transcription and capping of viral RNA. These viruses are unusually resistant to heat, a wide pH (3.0–9.0), and to lipid solvents but are sensitive to 95% ethanol, phenol, and chlorine. Reoviruses associated with human diseases are listed in Table 63-1.

## Orbiviruses

Orbiviruses are primarily animal pathogens that cause disease mainly in animals. They are so named for their ring-shaped (Latin word *orbi*: ring) structure. These viruses are differentiated from the orthoreoviruses by their protein structure and their transmission by arthropod vectors. The genus *Orbivirus*

consists of 19 species and at least 130 subspecies. The orbiviruses are nonenveloped viruses with two-layered capsids. The genome consists of 10 segments of double-stranded RNA. The virion measures 70–80 nm in diameter.

Unlike other reoviruses, the orbiviruses are sensitive to low pH. The orbiviruses mainly cause disease in animals, such as sheep, cattle, goats, and wild ungulates. They are associated with African horse sickness in horses, donkeys, and dogs; blue tongue disease in sheep; and epizootic hemorrhagic fever in deer.

Only few of orbiviruses are linked to disease in humans. Kemerovo virus has been implicated in neurological infections in Russia and Central Europe. Lebombo virus, a virus isolated in Africa, has been implicated with clinical disease in humans. Orbiviruses cause a severe flu-like disease, encephalitis, and polyradiculitis in humans. Fever, headache, and myalgia are the common manifestations. Rarely, the cases are complicated by other neurological manifestations. Till date, fewer than 50 cases of orbivirus infection in humans have been reported from Africa, South and Central America, Russia, and Eastern Europe. No case is reported from India. Humans acquire infection by the bite of arthropod vectors including mosquitoes, ticks, gnats, and midges. Oklahoma tick fever or Kemerovo or Lipovnik virus infections are transmitted by bite of ticks, specifically *Ixodes* ticks. However, bite of mosquitoes transmits orbivirus infections in Africa and South America. Orbivirus infections are mostly asymptomatic.

Changuinola virus has been implicated in a single documented case of an acute self-limited febrile illness in Panama. The disease is transmitted by *Phlebotomus* flies. Orungovirus found in parts of Sub-Saharan Africa causes an acute illness characterized by headache, fever, and myalgia. The virus is transmitted primarily by *Aedes* mosquitoes. Oklahoma tick fever, reported in Oklahoma and Texas in the United States, is transmitted by ticks. The condition manifests as fever, nausea, and abdominal pain.

The diagnostic facilities for orbivirus infections are available only in a few reference laboratories.

TABLE 63-1

Diseases associated with reoviruses

Virus	Diseases
<b>Orbiviruses</b>	
Kemerovo virus	Oklahoma tick fever in Oklahoma and Texas in the United States
	Neurological infections in Russia and Central Europe
Orungovirus	Acute illness with headache and myalgia in Africa
Lebombo virus	Clinical illness in humans in Africa
Changuinola virus	An acute self-limited febrile illness in Panama (a single case)
<b>Coltiviruses</b>	
Colorado tick fever virus	Colorado tick fever
Orthoreoviruses	Mild upper respiratory tract illness, gastrointestinal tract illness, and biliary atresia
Rotavirus	Diarrhea in infants and young children

## Key Points

- The virus can be isolated by culture in Vero or baby hamster kidney (BHK)-21 cells and by inoculation in suckling mice.
- Complement fixation test, neutralization test, and enzyme immunoassays are used for serodiagnosis of orbiviral infections. A fourfold rise in antibody titer in acute and convalescent sera is suggestive of orbiviral infections.
- ELISA for detection of virus-specific IgM antibodies in the cerebrospinal fluid is useful for diagnosis of patients with neurological complications, such as meningitis or encephalitis.

No specific antiviral agents are available. Use of insect repellents, protective clothing, and avoidance of tick bite prevent transmission of orbivirus infections.

## Coltiviruses

Coltivirus resemble the orbiviruses in their morphology and in having two capsids. The genome consists of a 12-segmented double-stranded RNA. The coltivirus associated with human disease include Colorado tick fever, Salmon River virus, Banna virus, Beijing virus, Gansu virus, and Eyach virus.

### Colorado Tick Fever Virus

Colorado tick fever is an acute viral infection transmitted by the bite of wood tick (*Dermacentor andersoni*) caused by Colorado tick fever virus. Colorado fever was so named because the illness was believed to occur predominantly in Colorado and was used to distinguish this clinical illness from that of Rocky Mountain spotted fever caused by *Rickettsia* species. The causative agent of this fever was recognized as a virus in 1946.

Colorado tick fever virus is a double-stranded RNA virus surrounded by two capsids. The virus contains 12 RNA segments. The virus infects and replicates in the bone marrow, lymph nodes, spleen, and liver of rhesus monkey, but without producing any histological abnormalities. The virus has been shown to replicate in erythroid precursor cells without severely damaging them and is present in mature red blood cells.

Colorado tick fever occurs almost exclusively in the Western United States and in Canada. The disease is transmitted by the bite of wood tick, *D. andersoni*. Larval and nymphal stages of *D. andersoni* ticks usually transmit the virus among all rodents, but only adult ticks transmit the virus to humans. The ticks acquire the infection on feeding an infected viremic host. The infected ticks subsequently transmit the virus through their saliva during act of feeding on a new susceptible host. Squirrels, rabbits, and deer are the natural animal hosts for the virus.

The virus generally causes a nonspecific febrile illness. The incubation period is short and varies from 3 to 6 days. The clinical manifestations of the acute condition are characterized by the sudden onset of fever, chills, headache with retro-orbital pain, malaise, nausea, and occasionally vomiting. A rash is generally absent by which Colorado tick fever is differentiated from the Rocky Mountain spotted fever.

The fever is typically biphasic (i.e., with two episodes of fever), each of which lasts 2–3 days, separated by a remission of approximately equal duration. In most cases, the febrile period is followed by moderate to marked weakness and malaise. Complications are rare, but may include hepatitis, pericarditis, epididymo-orchitis, atypical pneumonitis, encephalitis, and aseptic meningitis.

Viruses are present in the erythrocytes during the first 2 weeks of disease. This is followed by a period during which the viruses infect and replicate within the erythropoietic cells. In the infected red blood cells, the viruses can live for the life of the cells, which is nearly 120 days. A single attack of infection usually produces lifelong immunity.

Laboratory diagnosis of Colorado tick fever is established by isolation of the virus from the erythrocyte fraction of the whole blood. The virus has been shown to persist in erythrocytes for as long as 120 days. The virus has also been found in the cerebrospinal fluid of patients with no apparent encephalitis or meningitis. The virus isolation, however, takes nearly 1–2 weeks.

Neutralization test in suckling mice, tissue culture neutralization, immunofluorescence, and enzyme immunoassay are various serological tests used for demonstration of antibodies in the serum for diagnosis of the condition. A fourfold increase in titer of the specimen during the acute phase and convalescent phase is demonstrated in nearly all patients.

### Key Points

- Direct fluorescent antibody method is a rapid and the most useful method for demonstration of viral antigen directly on the surface of erythrocytes in a blood smear.
- A new RT-PCR has been used nowadays to detect viral genome in the red blood cells and to establish diagnosis of the condition as early as from the first day of the symptoms.

No specific antiviral treatment is available for Colorado tick fever. The condition is usually self-limited and can be prevented by avoiding contact with the wood tick.

## Orthoreoviruses

Orthoreoviruses are nonenveloped viruses, measuring 80 nm in diameter. It is composed of an inner protein shell, i.e., core and an outer protein shell known as outer capsid. The inner core is composed of three major lipids,  $\gamma 1$ ,  $\gamma 2$ , and  $\sigma 2$ , and many minor proteins. The core consists of a 10-segmented double-stranded RNA. The reoviruses have three serotypes, namely, type 1, 2, and 3, based on neutralization and hemagglutination inhibition test. All these serotypes share a common complement fixation antigen.

The reoviruses are very stable. They are stable to heat, to a wide range of pH, and are also stable in aerosols. Reoviruses can be cultured in monkey kidney cells, HeLa cells, and mouse L-cell fibroblast.

Human volunteers' studies have failed to establish a clear cause-and-effect relationship between reoviruses and human illness. So far, reoviruses have been linked with upper respiratory infection, fever, enteritis, and febrile exanthema in children. All three serotypes of the virus have been recovered from healthy children and from children with minor febrile illness, diarrhea, or enteritis. The exact method of transmission of reoviruses is not known. Since viruses are isolated most frequently from the feces, the infection appears to be transmitted by the fecal–oral route.

Recent studies have shown the potential of reovirus as an oncolytic virus and have shown the susceptibility of transformed cell to reovirus replication. It has been demonstrated that normal nontransformed cells were resistant to the virus. Reovirus causes *oncolysis* (apoptotic cell death) in a wide variety of cancer cells and tumors.

Results of many studies have shown a possible role of reovirus in the treatment of brain and leptomeningeal metastasis from

breast cancer. The beneficial role of reovirus in reducing the sequential spinal and leptomeningeal metastasis from medulloblastoma has also been suggested. The laboratory diagnosis of the human orthoreovirus infection can be made by:

- The isolation of the virus and detection of the viral antigen and RNA genome in various clinical specimens, such as feces, throat swabs, and nasopharyngeal specimens.
- The serological tests, such as hemagglutination inhibition, complement fixation, or virus neutralization to demonstrate antibodies. These serological tests are used primarily for epidemiological studies.

No specific treatment is available for orthoreovirus infection. No preventive measures have been suggested due to the lack of definitive association of orthoreovirus with human disease.

## Rotavirus

Rotavirus is the most common agent of gastroenteritis in children aged 6 months to 2 years.

### Properties of the Virus

#### ► Morphology

Rotavirus shows following features:

- The rotavirus has a distinctive morphological appearance by negative stain EM. The virus measures 70 nm in diameter and possesses three-layer icosahedral capsid without an envelope.
- The sharply defined circular outline of the outer capsid gives the appearance of the rim of a wheel placed on short spokes radiating from a wide arm. This appearance gives the virus the name “*rota*” (Latin word which means wheel).
- The genome consists of a segmented double-stranded RNA genome. The outer shell is composed of a major glycoprotein with a molecular weight of 34,000 Da. This protein is known as viral protein (VP7). It also consists of a minor trypsin-sensitive protein with a molecular weight of 84,000 Da. This protein is now designated as VP4, which was earlier called VP3. The minor shell or core protein of the virus core consists of four proteins: VP1, VP2, VP3, and VP6. The virus also consists of six nonstructural proteins (NS53, NS34, NS35, NS28, NS26, and NS12).

#### ► Viral replication

Rotaviruses replicate in cytoplasm of the host cell. Infection of the cell begins by attachment to the cell surface at the site of beta-adrenergic receptor. After entry into the cell, the virion uncoats and in the cytoplasm the RNA-dependent RNA polymerase synthesizes mRNA from each of the 10–11 segments. These mRNAs encode a variety of structural and nonstructural proteins. RNA polymerase is one of those proteins that synthesizes minus strands, which become a part of progeny virus.

Capsid proteins, subsequently, form an incomplete capsid around the minus strands. Later on, the plus strands of progeny genome segment are synthesized. Finally, the virions are released by lysis of the cell.

#### ► Antigenic and genomic properties

Human and animal rotaviruses have been classified into different serotypes, groups, and subgroups. Human rotaviruses have been classified to a total of 11 G serotypes primarily based on the VP7 (glycoprotein G) and VP4 (protease-sensitive protein P) proteins. Serotypes G1, G2, G3, or G4 have been identified with a majority of infections and are designated as serotype 1, 2, 3, or 4, respectively. There are six different HRP-P types. P type 1 is usually associated with G type 1, 3, or 4, whereas P type 1b is usually associated with a type 2.

Rotaviruses are classified into seven groups (from A to G) based on the antigenicity of VP6 and the electrophoretic mobility of the genomic segments. Human disease is caused mostly by group A and occasionally by group B and C rotaviruses.

#### ► Other properties

Rotaviruses are relatively stable at low temperature. They are also stable at extremes of pH (3.5–10) and also to repeated freezing and thawing. Treatment with proteolytic enzymes, such as trypsin, enhances the infectivity of the virus.

### Virus Isolation

#### ► Culture

Human rotaviruses are also difficult to grow. They do not grow readily in cell cultures. Rotavirus growth is facilitated if the viruses are pretreated with proteolytic enzyme, trypsin, and if low levels of trypsin are included in tissue culture medium. This causes cleavage of outer capsid protein of the virus and thereby facilitates uncoating.

### Pathogenesis and Immunity

Rotavirus is transmitted by feco–oral transmission.

#### ► Pathogenesis of rotavirus diarrhea

Rotavirus survives the acidic environment in the stomach and initiates infection in the mucosal cells of the small intestine. It does not cause infection in mucosa of the stomach and large intestine. After absorption, the viruses replicate in the cytoplasm of the enterocytes and damage their transport mechanism.

Non-structural protein 4 (NSP4) of the rotavirus may act as a viral enterotoxin, which causes secretion of fluids by stimulating a signal transduction pathway. The toxin induces influx of calcium ion into enterocytes and release of neuronal activators, and alters sodium and glucose absorption. The resulting diarrhea is due to impaired sodium and

glucose absorption, as damaged cells on the villi are replaced by nonabsorbing immature crypt cells.

The rotavirus after replicating in the cell causes damage to the cell. The damaged cells are released into the lumen of intestine, releasing large quantities of viruses in the diarrheic stool. It takes around 3–8 weeks for restoring the normal function of the cell. Hence, the rotavirus produces watery diarrhea similar to that seen in cholera.

### ► Host immunity

Rotavirus infection is characterized by the presence of high quantity of immunoglobulin A (IgA) in the intestinal secretions. The IgA plays an important role in conferring the gut immunity against rotavirus. It protects newborns up to the age of 6 months. The serum antibodies usually reduce the severity of the disease, but not necessarily prevent reinfection. Even a small quantity of a virus may cause infection and diarrhea in the absence of specific antibodies in the serum.

## Clinical Syndrome

Rotavirus is a major cause of diarrhea in infants and young children.

### ► Diarrhea

The incubation period is short being less than 48 hours. The condition manifests commonly as fever, vomiting, diarrhea, and occasionally dehydration. Vomiting is usually of short duration and can occur before or after the onset of diarrhea. The diarrheic stool may be watery, green, or yellow but does not contain mucus. Rotavirus diarrhea is a self-limiting disease, and patients recover completely within 5–10 days without any complications or sequelae. Also, rotavirus has been reported as an agent of traveler's diarrhea in adults. The virus has also been reported to cause gastroenteritis in adults.

## Epidemiology

Rotavirus is found worldwide. The virus is an important cause of diarrhea in infants and young children between 3 and 5 years of age. The viruses are excreted in the diarrheic stool of the children 2–5 days after the start of diarrhea. The infected children are the common source and reservoir of infection. The virus is transmitted from person-to-person by fecal–oral route. The virus is resistant to environmental condition, hence survives well on fomites, as well as on hands. The rotavirus diarrheal disease shows a seasonal variation; the disease being more common in autumn, spring, and winter.

## Laboratory Diagnosis

### ► Specimen

Diarrheic stool is the specimen of choice for demonstration of rotavirus and viral antigens.

### ► Microscopy

Rotavirus can be demonstrated in stool by direct electron microscopy (EM) and by immunoelectron microscopy (IEM).

### Key Points

- Direct EM is a rapid method for detecting rotavirus in the fecal specimen. EM detects typical 70-nm cart-wheel-shaped viruses in the stool. The sensitivity of this method, however, is low.
- On-grid IEM is a three times more sensitive and reliable method than the conventional EM for demonstration of rotaviruses in the stool.

### ► Direct antigen detection

Enzyme immunoassay, such as Rotazyme and latex agglutination test, are useful tools to detect rotavirus antigen directly in the stool for diagnosis of diarrheal illness. This is a method used for routine diagnosis of rotavirus diarrhea.

### ► Isolation of the virus

Rotaviruses are difficult to grow in cell culture, hence are not routinely used for diagnosis of rotavirus diarrhea.

## Treatment

No specific antiviral therapy is available for rotavirus infection. The treatment of the condition is mostly supportive. It consists of restoring the fluid loss in dehydrated patients. Oral rehydration fluid using glucose and electrolyte solution is currently preferred than the intravenous fluids to restore the hydration. Intravenous fluids are used only in severely dehydrated children.

## Prevention and Control

Few vaccines have been evaluated to protect children from rotavirus diarrhea. Improved personal hygiene including hand washing and isolation of known cases of rotavirus are the best modes of control of the rotavirus diarrhea.

### Vaccines

A rhesus–human reassortant rotavirus tetravalent vaccine (RRV-TV; Rota shield) is a recent vaccine being used since 1998. The vaccine consists of a polyvalent preparation consisting of the VP7 protein of each of the four clinically important serotypes with the attenuation phenotype of the rhesus rotavirus. This has been successful in preventing severe rotavirus diarrhea in two different studies conducted in Finland with protection rates of 80–91%. In developing countries, such as Peru and Brazil, the efficacy of this vaccine has been less impressive, varying between 20% and 30% protection rates in children.

**CASE  
STUDY**

A 1-year-old child was admitted to the pediatrics ward with complaints of watery diarrhea, vomiting, and low-grade fever. The child was dehydrated. Routine laboratory investigations ruled out any bacterial or parasitic etiology. The diarrhea was strongly suspected to be due to rotavirus.

- What are the other viral agents that can cause diarrhea in a child?
- What are the laboratory tests you would like to perform to confirm rotavirus etiology of the diarrhea?
- How is the virus transmitted? Describe the mechanism of diarrhea?
- What are the vaccines available against rotavirus diarrhea?



# Rhabdoviruses

## Introduction

Rabies virus is the most important member of the rhabdoviridae family, which causes disease in humans. It causes rabies, a recognized zoonotic disease worldwide. Rabies is the most fatal infection in humans. No specific antirabies agents are useful, once clinical signs or symptoms develop.

## Classification

The family Rhabdoviridae is classified into two genera: *Lyssavirus* and *Vesiculovirus*. The genus *Lyssavirus* consists of more than 80 viruses and includes a rabies serogroup, which consists of 10 viruses including the classic rabies virus. The rabies virus is the prototypical human *Lyssavirus* pathogen. Other viruses included in this group are Mokola virus, Duvenhage virus, Obodhiang virus, Kotonkan virus, Rochambeau virus, European bat *Lyssavirus* types 1 and 2, and Australian bat *Lyssavirus*. These viruses rarely cause human disease. The genus *Vesiculovirus* includes vesicular stomatitis virus and other viruses infecting vertebrates and invertebrates.

## Rabies Virus

Rabies virus causes rabies, a viral infection of the central and peripheral nervous systems that causes encephalitis with or without paralysis. It is mostly fatal.

## Properties of the Virus

### ► Morphology

Rabies virus shows following features:

- It is a bullet-shaped virus with one end rounded or conical and the other end planar or concave (Fig. 64-1).
- It is a negative-sense, nonsegmented, single-stranded RNA virus measuring approximately  $60 \times 180$  nm.
- It is composed of an internal protein core or nucleocapsid, which contains the nucleic acid. It also consists of an outer envelope, a lipid-containing bilayer covered with transmembrane glycoprotein spikes. The nucleocapsid shows helical symmetry, containing a linear negative-sense RNA with an RNA-dependent RNA transcriptase. The virus genome is unsegmented.

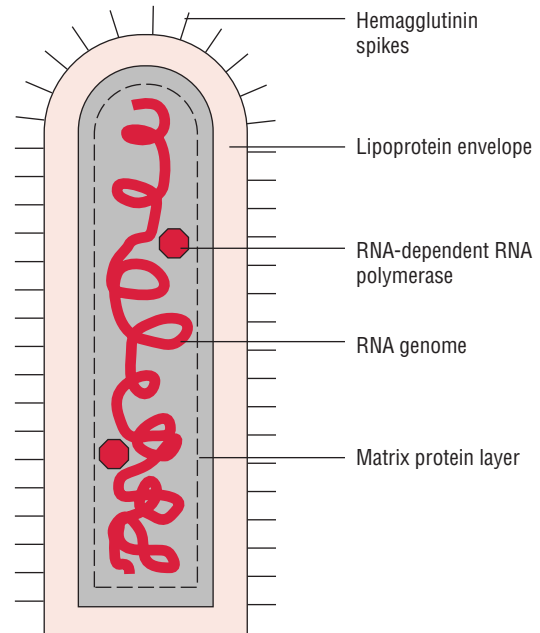

**FIG. 64-1.** A schematic diagram of rabies virus.

The genome encodes for production of five proteins associated with either the ribonucleoprotein (RNP) complex or the viral envelope. The L (transcriptase), N (nucleoprotein), and NS (transcriptase-associated) proteins comprise the RNP complex, together with the viral RNA. These proteins are aggregated together in the cytoplasm of virus-infected neurons and constitute Negri bodies, the characteristic histopathological finding of rabies virus infection. The M (matrix) and G (glycoprotein) proteins are associated with the lipid envelope. The G protein forms the protrusions that cover the outer surface of the virion envelope and is the only rabies virus protein known to induce virus-neutralizing antibody.

### ► Viral replication

Rabies virus replicates in the cytoplasm. It causes infection by combining with the acetylcholine receptor of the cell surface. The virus then enters the cell, uncoats, and the viral RNA polymerase synthesizes five mRNAs that encode viral proteins. The virus-encoded RNA polymerase facilitates the replication of the viral genomic RNA, which is followed by assembly of the genomic RNA with virion proteins to form the nucleocapsid. Finally, the virions bud from plasma membrane by budding through the cell membrane, during which they acquire their envelopes.

### ► Antigenic and genomic properties

Rabies viruses of humans and animals are of single antigenic type. Rabies virus contains the following antigens:

**G protein:** The glycoprotein or G protein is present on the surface spikes present on the outer lipoprotein envelope of the virion. It mediates the attachment of virus to the acetylcholine receptors of neural tissues. The G protein is important in pathogenesis and virulence of the virus. It is strongly antigenic and elicits the production of neutralizing antibodies, which are protective. It also induces hemagglutination-inhibiting antibodies and stimulates cell-mediated immunity. G protein is a serotype-specific antigen.

**N protein:** Nucleoprotein or N protein is a group-specific antigen. It shows cross-reaction with some rabies-related viruses. It is antigenic and produces antibodies, which are not protective but are of diagnostic value. These antibodies can be demonstrated by serological tests, such as immunofluorescence (IF) test for the purpose of diagnosis.

**Other antigens:** These include membrane proteins, glycolipid, and RNA-dependent RNA polymerase.

### ► Typing of strains

Rabies viruses may be typed as fixed or street viruses. The *fixed viruses* are the viruses that by several intracerebral passages in animals or cell culture undergo certain changes, such as they show a fixed incubation period of 6–7 days. The *street viruses* are those viruses that are isolated from natural human and animal infections and show a variable incubation period of 1–12 weeks.

The monoclonal antibodies and genetic sequencing are now being used to differentiate and type street rabies viruses. Typing of street viruses has been found to be helpful in identifying viral variants originating in major host reservoirs throughout the world. This is also found to be useful to suggest the likely sources of human exposure when a history of definitive animal bite was otherwise missing from a patient's case history. Differences between fixed and street viruses are summarized in Table 64-1.

### ► Other properties

Rabies virus possesses hemagglutinating property. The virus agglutinates goose erythrocytes at 0–4°C and at pH 6.2. Rabies virus is sensitive to ethanol, iodine, soap, quaternary ammonium compounds, detergents, ether, chloroform, acetone, etc. It is inactivated by formalin, phenol, beta-propiolactone, ultraviolet radiation, and sunlight. It can be inactivated at 50°C

for 1 hour or at 60°C for 5 minutes. It can also be inactivated on exposure to CO<sub>2</sub>. The virus is resistant to drying and cold. It survives at 4°C for weeks; hence viruses can be preserved by storing at –70°C or by lyophilization.

## Virus Isolation and Animal Susceptibility

### ► Embryonated egg

The rabies virus grows in the yolk sac of the chick embryo. The rabies vaccine strains, such as Flury and Kelev strains, are grown in the yolk sac.

### ► Cell culture

Rabies virus can grow in several primary and continuous cell cultures. These are WI-38, BHK (baby hamster kidney)-21, and chick embryo-related (CER) chick embryo fibroblast, and porcine, mouse, or hamster kidney cell lines. The fixed virus strains are adapted to grow in vero and human diploid cell lines. The cytopathic effect produced by the virus in the cell lines is minimal.

### ► Laboratory animals

Mouse is the animal of choice. Intracerebral route is the frequently used route of infection. Intracerebral inoculation causes encephalitis, and the inoculated mouse die within 5–30 days.

## Pathogenesis and Immunity

Rabies virus has a broad host range. The virus can infect all mammals, although certain mammals (such as dogs, foxes, wolves, and bats) are important for transmission of infection.

### ► Pathogenesis of rabies

The virus may enter the peripheral nervous system directly at the site of bite. In some cases, however, it may replicate in muscle tissue after entering the host, remaining at or near the site of introduction for most of the incubation period. However, the precise sites of viral sequestration remain unknown, since neither the antigen nor the virus can usually be found in any organ during this phase.

The virus infects the sensory neurons and moves rapidly by axonal transport centripetally to the central nervous system (CNS) for replication. During its transport within the neurons, it is protected from the host immune system. The virus travels along the axons at a rate of 12–24 mm in a day to enter the

TABLE 64-1

Differences between street and fixed rabies viruses

Street virus	Fixed virus
Virus is isolated from natural human or animal infection	Virus is isolated after several serial intracerebral passages in rabbits
Can cause fatal encephalitis in laboratory animals after a long incubation period of 1–12 weeks	Neurotropic but much less infective. Can cause fatal encephalitis in laboratory animals after a short and fixed incubation period of 6–7 days
Negri bodies can be demonstrated in the brain of infected animals	Negri bodies cannot be demonstrated in the brain of infected animals
Cannot be used for vaccine production	Can be used for vaccine production

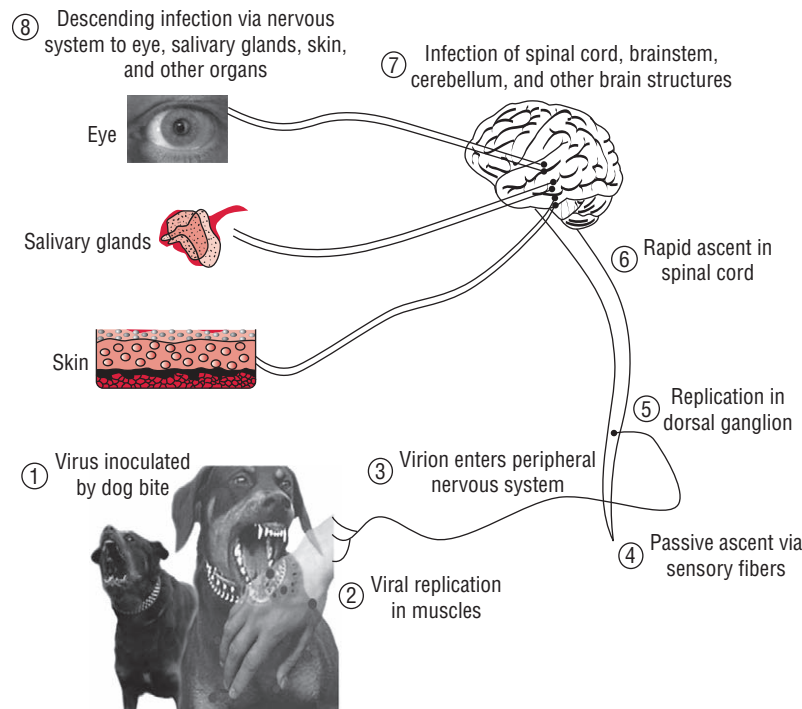

FIG. 64-2. Pathogenesis of rabies in humans.

spinal ganglion. Its multiplication in the ganglion is indicated by the onset of pain or paresthesia at the site of the inoculum, which are the first clinical symptom and a hallmark finding. From here, the virus spreads quickly, at a rate of 200–400 mm/day, into the CNS, and the spread is marked by rapidly progressive encephalitis. Thereafter, the virus spreads to the periphery and salivary glands (Fig. 64-2).

During the course of infection, encephalitis develops, associated with the death of neurons and demyelination. Acidophilic intracytoplasmic neuronal inclusion bodies are found in infected neurons, which is important for laboratory diagnosis.

### ► Host immunity

Production of cytokines (such as interferon), induced during rabies virus infection or vaccination, has been reported to abort the disease if it occurs shortly after viral infection. Recently, it has been demonstrated that animals immunized with purified RNP complexes or recombinant nucleoprotein vaccines resisted lethal challenge with rabies virus. However, the role of N protein in protection, illness, or recovery is unclear.

## Clinical Syndrome

Rabies virus causes rabies, the most fatal infection in humans. No specific antirabies agents are useful, once clinical signs or symptoms develop.

### ► Rabies

In general, four stages of rabies are recognized in humans. These are (i) incubation, (ii) prodromal period, (iii) acute neurologic period, and (iv) coma; which subsequently lead to death.

**Incubation period:** The average period of incubation is 20–90 days. Rarely, incubation lasts as long as 19 years. In more than 90% of cases, incubation is less than 1 year. During the incubation period, the virus travels from peripheral areas to the CNS. The patients remain asymptomatic during the period. The incubation period is less than 50 days if the patient is bitten on the head or neck or if a heavy inoculum is transferred through multiple bites, deep wounds, or large wounds. A person with a scratch on the hand may take longer to develop symptoms of rabies than a person who receives a bite on the head. The rabies virus is protected from the immune system during this period and no antibody response is observed.

**Prodromal period:** The virus enters the CNS during the prodromal period. The duration of this period is 2–10 days. The period is characterized by nonspecific symptoms and sign Paresthesia or pain develops at the inoculation site and is pathognomonic for rabies. Paresthesia occurs in 50% of cases during this phase and may be the patient's only presenting sign. Other symptoms may include malaise, anorexia, headache, fever, chills, pharyngitis, nausea, emesis, diarrhea, anxiety, agitation, insomnia, and depression.

**Acute neurologic period:** This period is associated with objective signs of developing CNS disease. The duration is 2–7 days. Furthermore, it presents with the following conditions:

**Furious rabies:** Patients develop agitation, hyperactivity, restlessness, thrashing, biting, confusion, or hallucinations. After several hours to days, this becomes episodic and interspersed with calm, cooperative, lucid periods. Furious episodes last for less than 5 minutes. Episodes may be triggered by visual, auditory, or tactile stimuli, or they may be spontaneous. Seizures may occur.

## Key Points

- Hydrophobia and aerophobia are pathognomonic for rabies and occur in 50% of patients. Attempting to drink or having air blown in the face produces severe laryngeal or diaphragmatic spasms and a sensation of choking.
- This may be related to a violent response of the airway irritant mechanisms. Even the suggestion of drinking may induce hydrophobic spasm.

Autonomic instability is observed, including fever, tachycardia, hypertension, hyperventilation, drooling, anisocoria, mydriasis, lacrimation, salivation, perspiration, and postural hypotension. Other neurologic signs include cranial nerve involvement with diplopia, facial palsy, and optic neuritis. This phase may either end in cardiorespiratory arrest or progress to paralysis.

**Paralytic rabies:** It is also known as dumb rabies or apathetic rabies, because the patient is relatively quiet compared to a person with the furious form. Paralysis develops from the outset. Fever, headache, and nuchal rigidity are prominent. Paralysis is symmetric and may be either generalized or ascending and may be mistaken for Guillain-Barré syndrome. Calmness and clarity gradually deteriorates to delirium, stupor, and then coma.

**Coma:** The patient may go into coma within 10 days of onset; but duration is variable. Coma leads to respiratory failure within a week of neurologic symptoms. Hypoventilation and metabolic acidosis predominate. Acute respiratory distress syndrome is common. Without intensive supportive care, respiratory depression, arrest, and death occur shortly after coma. Most cases result in death within 14 days because of complications, despite intensive supportive care. Recovery is very unlikely. A few reports indicate that those patients who survived had pre-exposure or postexposure prophylaxis supported by most advanced life-support system.

## Epidemiology

Rabies is a recognized zoonotic disease worldwide.

### ► Geographical distribution

Rabies has been recognized for over 4000 years. Today it is found in most countries, except many Australian islands, Great Britain, Japan, Hawaii, and most of the Caribbean islands. The risk of rabies is highest in countries with hyperendemic canine rabies, including most of Asia, Africa, and Latin America.

Rabies is endemic in India. It has been estimated that more than 30,000 people die of rabies in India every year. More than 70,000 people in India receive antirabies vaccination per year. With the dog population of over 16 million, the problem of rabies is huge. The virus is usually transmitted from a rabid animal to humans mostly by bites or other forms of traumatic contacts.

### ► Reservoir, source, and transmission of infection

Rabies is a zoonotic disease. Dogs are the important reservoir of infection. Other animal reservoirs include silver-haired bats,

eastern pipistrella, raccoons, skunks, foxes, or cats, ferrets, cattle, opossums, fowl, etc. Foxes are more infectious than dogs and other animals, because larger amounts of virus (up to  $10^6$  infectious doses/mL) are present in their saliva.

The virus is excreted in saliva of infected dogs, foxes, wolves, jackals, vampire bats, raccoons, and skunks. The virus is found in the salivary gland of these infected animals. Infected saliva or infected CNS tissue, including corneal transplants in humans, are the sources of infection. The virus is transmitted to humans by following ways:

- Bite of a rabid dog or other infected animals is the main route of transmission of infection.
- Contact of saliva with broken skin or with mucous membranes, exposure to aerosolized secretions from an infected animal, and contact with unpasteurized milk from dairies are very uncommon modes of transmission.
- Corneal transplants: The only documented cases of rabies caused by human-to-human transmission occurred in eight recipients of transplanted corneas. Currently, donated corneas are not accepted if the donor died from encephalitis that may be consistent with rabies. In India, few such cases have also been documented.

With the exception of corneal transplants, man-to-man infection is rare.

## Laboratory Diagnosis in Humans

### ► Specimens

Saliva, serum, cerebrospinal fluid (CSF), blood, urine, and skin and brain biopsy are the frequently used specimens for diagnosis of rabies.

### ► Microscopy

Demonstration of Negri bodies by microscopy is the characteristic histopathological feature of rabies (Fig. 64-3, Color Photo 59). Impression smears of the human brain tissue collected at postmortem are stained by Seller's technique for demonstration of Negri bodies. The stain contains methylene blue alcohol as fixative and basic fuchsin as staining reagent.

## Key Points

**Negri bodies** are demonstrated in 80% of human cases of rabies. Therefore, failure to demonstrate Negri bodies in neural tissue does not rule out the diagnosis of rabies.

- Negri bodies are made up of a finely fibrillar matrix and rabies virus particles.
- They appear as intracytoplasmic, round or oval, purplish pink structures with characteristic basophilic inner granules on staining by Seller's technique.
- They measure 3–27  $\mu\text{m}$  in size.
- They are found in the neural tissues and are found more in the cerebellum and hippocampus.
- They are not found in non-neural tissues, such as corneal specimen, saliva, or skin.

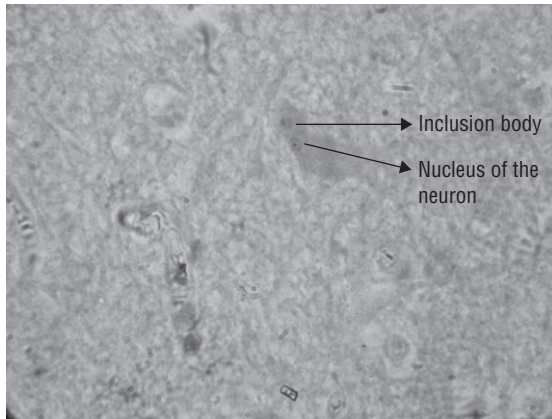

**FIG. 64-3.** Negri bodies in neural tissue ( $\times 1000$ ).

## Direct Antigen Detection

Viral antigens can be demonstrated in the corneal smear, skin biopsy collected from the face or neck, and saliva (antemortem) or in the brain tissue (postmortem) for diagnosis of rabies. Direct fluorescent antibody (DFA) test using specific monoclonal antibodies is a specific method to demonstrate rabies antigen in clinical specimens.

### Isolation of the virus

Viruses can be isolated from brain tissue, CSF, saliva, and urine by culture in cell lines or in animals.

**Culture:** Isolation of virus in cell lines (WI-38, BHK-21, and CER) is a sensitive method. The cytopathic effect produced by the virus is minimal; hence, the presence of virus in the inoculated cell cultures is made by demonstration of viral antigen within 2–4 days. The DFA test using monoclonal rabies antibodies tagged with fluorescein isothiocyanate is a frequently used specific method to demonstrate the antigen.

**Animal inoculation:** Mouse is the animal of choice. CSF, saliva, and urine are inoculated intracerebrally. The inoculated mice are observed for the signs of clinical illness. After death of the mice or after 28 days of inoculation, the brain tissues are examined for the presence of Negri bodies by microscopy or for viral antigen by the DFA test.

### Serodiagnosis

Rabies antibodies are found in the serum as well as in the CSF of human cases. A high titer of antibodies is found in the CSF. Antibodies in the serum are demonstrated by a rapid fluorescent focus inhibition test titer in which results are positive in 50% of cases. In the CSF, positive antibody titers (2–25% of serum titer) are found after the first week of illness.

## Molecular Diagnosis

Polymerase chain reaction is being increasingly evaluated for the diagnosis of rabies. The nucleic acid sequence-based amplification (NASBA) on saliva and CSF can be used for rapid diagnosis as early as 2 days after symptom onset. The NASBA technique on urine samples may be used in the future.

### Other tests

WBC count ranges from normal to elevated, with 6–8% atypical monocytes. Albuminuria and sterile pyuria may be observed. Respiratory alkalosis due to hyperventilation develops in the prodromal and early acute neurologic phases, which is followed by respiratory acidosis as respiratory depression progresses. In the CSF, after the first week of illness, 80% monocytosis is observed. Protein and glucose test results are normal.

### Antemortem diagnosis of human rabies

Until recently, most of the cases of rabies were fatal and patients used to die of the rabies. But with intensive support care and better management of patients, few cases have survived. Hence in such situations, laboratory methods for antemortem diagnosis of rabies in humans are proving to be more useful.

## Key Points

- Corneal smears, skin biopsy from nape of the neck or face, and saliva are the usual specimens.
- Diagnosis is made by demonstration of rabies virus antigen by IF or the viral DNA by molecular methods.
- Nucleic acid sequence based amplification (NASBA) on saliva and CSF can be used for rapid diagnosis as early as 2 days after symptom onset.

## Laboratory Diagnosis in Animals

Laboratory diagnosis of rabies in dogs and other animals is useful to assess the risk of infection and to monitor postexposure prophylaxis in humans bitten by the animals.

### Specimens

The brain of the dead animal is the specimen of choice. The brain is collected carefully from the dead animal. Part of the specimen is collected in 50% glycerol saline (preservative) for isolation of virus. The other part of the brain including the hippocampus and cerebellum (abundant in Negri bodies) is collected in Zenkers' fixative for demonstration of Negri bodies.

### Microscopy

Impression smears of the brain tissue are stained by Seller's technique for demonstration of Negri bodies. This is still a useful method in the laboratories lacking facilities for cell culture and antigen detection methods.

### Direct antigen detection

Demonstration of viral antigens in the infected brain tissue and in saliva of the animal by DFA is a useful method for diagnosis of rabies in animals. Detection of antigen in the saliva shows whether the animal was excreting the virus in the saliva or not.

### Isolation of the virus

Viruses can be isolated from animal brain issue and saliva by culture in cell lines or in animals, as described earlier for diagnosis of human rabies.

## Treatment

No specific antirabies agent is available. Although until recently rabies was considered to be invariably fatal, it has now been demonstrated that complete recovery can occur from established rabies with intensive supportive care and management of complications.

## Prevention and Control

Specific prophylaxis in rabies, depending upon whether given before or after exposure can be discussed as pre-exposure prophylaxis and postexposure prophylaxis.

### ► Pre-exposure prophylaxis

Pre-exposure prophylaxis is given to persons at high risk, such as dog handlers, other animal handlers, and veterinarians. This is achieved by use of cell culture vaccines, which are more safe. Pre-exposure prophylaxis requires three doses of cell culture vaccines, given on day 0, 7, 21, or on day 0, 28, and 56. A booster dose is recommended after 1 year, and then one dose every year. Animal control and vaccination strategies now have stronger roles than postexposure prophylaxis in preventing the spread of rabies.

### ► Postexposure prophylaxis

Postexposure prophylaxis is started immediately after exposure to infection. After exposure to possibly infected dog or other rabid animals, immediate preventive actions are taken up, which consist of (a) local treatment, (b) confirmation whether or not the animal is rabid, (c) administration of hyperimmune serum, and (d) antirabies vaccine.

**Local treatment:** This involves prompt cleaning of the wound. Animal bites deposit the virus in the wounds. The wound should be immediately scrubbed with soap and water followed by treatment with quaternary ammonium compounds, such as Cetavlon, tincture, or aqueous solution of iodine or alcohol.

**Confirmation whether or not the animal is rabid:** This can be made by clinical observation of suspected dog. If dog is still healthy 10 days after biting human, rabies is extremely unlikely. Diagnosis can also be made by demonstration of the Negri bodies in brain tissues at autopsy or viral antigens in the brain tissue or saliva.

**Administration of hyperimmune serum:** Passive immunization is carried out by administering purified equine rabies immune globulin (ERIG) and human rabies immune globulin (HRIG). Administration of HRIG is promptly made to ensure passive immunization against rabies. The recommended dose of HRIG is 20 IU/kg body weight. Fifty percent of the dose is given into the wound and 50% intramuscularly. It is usually given before or simultaneously with the first dose of the rabies vaccine. It is not given after injection of rabies vaccine. The recommendations for postexposure prophylaxis are presented in Table 64-2.

**Antirabies vaccine:** Rabies is the only disease where postexposure vaccination is employed extensively and successfully. This is due to long incubation period of the disease. The chances

TABLE 64-2

### Immunoprophylaxis in rabies\*

#### Category I

- Touching, feeding of animals or licks on intact skin
- No exposure
- Therefore, no treatment if history reliable

#### Category II

- Minor scratches or abrasions without bleeding or licks on broken skin
- Nibbling of uncovered skin
- Use vaccine alone

#### Category III

- Single or multiple transdermal bites, scratches or contamination of mucous membrane with saliva (i.e., licks)
- Use immunoglobulin plus vaccine
- Use vaccine alone

\*According to the World Health Organization Department of Communicable Diseases Surveillance and Response.

of preventing the rabies are more when vaccination is given to humans as early as possible after exposure. Since the time of Pasteur's successful use of a rabies vaccine obtained from desiccated preparation of spinal cord of rabbits in the year 1885, a wide variety of vaccines are being used worldwide to protect humans against rabies even after infection with the virus. Of late, neural-tissue vaccines are gradually being replaced by cell culture vaccines that are grown in human diploid cells and then inactivated with propiolactone (refer the box Vaccines). The list of such vaccines with their advantages and disadvantages are summarized in Table 64-3.

## Vaccines

**Cell culture vaccines:** These vaccines include human diploid cell vaccine, purified chick embryo cell vaccine, and purified vero cell vaccines. All these cell culture vaccines are equally effective and safe. The dosage schedule is same for children and adults. These are given intramuscularly or subcutaneously in the deltoid region in adults and on the anterolateral side of the thigh in children. Postexposure prophylaxis requires a course of five to six doses, starting as soon as possible.

- These are given, on days 0, 3, 7, 14, 30, and optionally, 90.
- The first dose on the day 0 is combined with an injection of human hyperimmunoglobulin (20 IU/kg). Vaccination with complete dosages gives virtually complete protection, for at least 5 years. During this period of 5 years, if any further exposure occurs, only one or two booster doses (on days 0, 3) may be given. After 5 years, a full course of five injections is given if the patient is again exposed to infection.

## Rabies-Related Viruses

The genus *Lyssavirus* consists of more than 80 viruses including the rabies virus, which is the prototypical human Lyssavirus pathogen. Other viruses included in this group rarely cause human disease.

TABLE 64-3

Different rabies vaccines: advantages and disadvantages

Type of vaccine	Advantages	Disadvantages
<b>Neural vaccines</b> (Semple vaccines, beta-propiolactone vaccine, and infant brain vaccine)	<ul style="list-style-type: none"> <li>■ Cheap and economical</li> </ul>	<ul style="list-style-type: none"> <li>■ Poor immunogens</li> <li>■ Encephalitogenic</li> <li>■ Associated with serious risk of neurologic complications</li> </ul>
<b>Non-neural vaccines:</b> Egg vaccines (duck egg vaccine, live attenuated chick embryo vaccine: Flury strain—LEP vaccine, HEP vaccine)	<ul style="list-style-type: none"> <li>■ Cheap</li> </ul>	<ul style="list-style-type: none"> <li>■ Poorly immunogenic</li> </ul>
<b>Tissue culture vaccines</b> (HDC vaccine from WI-38, MRC-5)	<ul style="list-style-type: none"> <li>■ Highly antigenic</li> <li>■ Free from side effects</li> </ul>	<ul style="list-style-type: none"> <li>■ Very expensive</li> </ul>
<b>Primary cell culture vaccines</b> grown on chick embryo, hamster and dog kidney cells and continuous cell culture vaccines grown on vero cells	<ul style="list-style-type: none"> <li>■ Highly immunogenic</li> <li>■ Economical</li> </ul>	<ul style="list-style-type: none"> <li>■ No particular disadvantage</li> </ul>
<b>Subunit vaccines:</b> Surface glycoprotein cloned and recombinant vaccine	<ul style="list-style-type: none"> <li>■ Very protective</li> <li>■ Safe</li> </ul>	<ul style="list-style-type: none"> <li>■ Still in experimental stages</li> </ul>

## Duvenhage Virus

The virus is classified as Lyssavirus serotype 4. The virus has been reported in bats from Southern Africa and many European countries. The first human case was reported in 1971 from South Africa, who died of clinical rabies after being bitten by a bat.

## Mokola Virus

The virus is classified as Lyssavirus serotype 3. The virus has been isolated from many domestic and wild animals (shrew, cat, and dog) in Africa. It was first reported from shrews in Africa in the year 1968. Later, the virus has been isolated from animals in many European countries. The first report of human infection was from two children with CNS infection.

## Lagos Bat Virus

The virus is classified as Lyssavirus serotype 2. The viruses have been reported from bats and cats in Nigeria and Central Africa. The virus was initially isolated in 1956 from the pooled brains of frugivorous bats from Lagos island, Nigeria. The virus causes a rabies-like illness following intracerebral inoculation in infected monkeys.

## Other Rabies-Related Viruses

Other viruses, such as Rochambeau virus and Australian bat Lyssavirus have been reported to cause occasional rabies-like fatal disease in humans. Obodhiang and Kotonkan viruses have only been reported from mosquitoes in Sudan and Ibadan. No human infection by these viruses has been documented.

### CASE STUDY

A 35-year-old hunter from rural India came with sore throat and had trouble in swallowing. The man was treated as usual with antibiotics by a local physician. That night, the man began to pace and spit frequently, his facial muscles twitched uncontrollably, and he became anxious and fearful. He was hospitalized. Physicians thought he might be suffering from a drug overdose or viral encephalitis. Although he remained alert for several days, he became increasingly agitated, he vomited, his body temperature rose to 106°F, and he died. His friend on enquiry revealed that the victim had a tussle with a dog while he was hunting 2 months ago.

- What is the possible cause for his death?
- What are the reservoirs for the organism?
- What are the presenting symptoms in case of this suspected infection?
- How can you confirm this condition in laboratory?

# Arboviruses

## Introduction

Arboviruses are RNA viruses that are transmitted by arthropods. The word *arbovirus* is an acronym for arthropod-borne viruses that are transmitted by arthropods, from one vertebrate host to another. Arbovirus is a collective name for a large group of viruses of which about 100 are known human pathogens. Most of the arboviruses causing infections in humans are zoonotic, with humans acting as accidental host. Humans play an important role in the maintenance or transmission of the virus in the cycle. Yellow fever virus and dengue virus are two exceptions, which are not zoonotic. The viruses multiply in tissues of the arthropod host without producing any disease. Some arboviruses are maintained in nature by transovarian transmission in arthropods.

Dengue, Japanese encephalitis (JE), yellow fever, Western equine encephalitis, Eastern equine encephalitis, St. Louis encephalitis, West Nile fever, and sandfly fever are some of the major arbovirus diseases distributed worldwide. In India, the most important arbovirus infections are JE, chikungunya fever, dengue, Kyasanur forest disease (KFD), Chandipura fever, and encephalitis.

## Classification

Arboviruses were named initially, according to the disease they cause, such as yellow fever virus, or depending upon the place from where they were first isolated, e.g., West Nile fever and St. Louis encephalitis. Taxonomically, most arboviruses and roboviruses are recently classified into five families, namely, Togaviridae, Flaviviridae, Bunyaviridae, Reoviridae, and Rhabdoviridae. Most viruses of medical importance are included in the family Togaviridae, some belong to family Flaviviridae, and some to families Reoviridae and Rhabdoviridae.

Togaviruses, flaviviruses, bunyaviruses, reoviruses, and rhabdoviruses associated with human infections are summarized in Table 65-1.

## Important Properties of Arboviruses

### The Viruses

#### ► Togaviruses

Togaviruses are single-stranded RNA viruses. They are spherical, 17 nm in diameter, and have an icosahedral nucleocapsid

### Togaviruses, flaviviruses, bunyaviruses, reoviruses, and rhabdoviruses associated with human infections

TABLE 65-1

Virus group	Human pathogens
<b>Togaviruses</b>	
Alphaviruses	Arboviruses, Chikungunya, eastern, western and Venezuelan equine encephalitis viruses
Rubiviruses	Rubella virus
<b>Flaviviruses</b>	
Bunyaviruses	Arboviruses, Hepatitis C virus
<b>Bunyaviruses</b>	
Reoviruses	Arboviruses, California encephalitis, Oropouche, and Turlock viruses
<b>Reoviruses</b>	
Orbiviruses	Arboviruses and Bluetongue viruses
<b>Rhabdoviruses</b>	
Vesiculovirus	Arboviruses

surrounded by an envelope. They replicate in cytoplasm of the infected host cell, and after assembly in the host cell they show budding through the cell membrane. All viruses are serologically related. Togaviruses are divided into two families: alphaviruses and rubiviruses.

The major togaviruses are chikungunya, Venezuelan, and Western equine encephalitis viruses, Eastern encephalitis viruses, Mayaro, O'nyong-nyong, Semliki Forest, and Sindbis viruses. Most of these viruses are transmitted by mosquito arthropods to humans.

#### ► Flaviviruses

Flaviviruses are similar to togaviruses in that they are also single-stranded RNA viruses and have an icosahedral nucleocapsid surrounded by an envelope. They differ from togaviruses in being small, only 40–50 nm in diameter; in contrast, the togaviruses are relatively large and have a diameter of 70 nm. The flaviviruses replicate in the cytoplasm and assembly of viruses occurs within endoplasmic reticulum. All flaviviruses are serologically related.

#### ► Bunyaviruses

Bunyaviruses are large, spherical (80–120 nm in diameter), and have a triple-segmented and a single-stranded RNA. They have a helical nucleocapsid surrounded by an envelope. They replicate in the cytoplasm, and the assembly of the



virion occurs by budding on smooth membrane of the Golgi system. The members of the family Bunyviridae are classified into four genera: *Bunyavirus*, *Hantavirus*, *Nairovirus*, and *Phlebovirus*.

### ► Reoviruses

Reoviruses are spherical viruses, measure 16–18 nm in diameter, and are nonenveloped viruses. The genome consists of a double-stranded RNA of 10–12 segments. Replication and assembly of the virus occurs in the cytoplasm of the host cell. Reoviruses are divided into two genera: *Coltivirus* and *Orbivirus*. Coltiviruses include Colorado tick fever virus, transmitted by ticks. Orbiviruses include African horse sickness virus and blue tongue virus.

### ► Rhabdoviruses

Rhabdoviruses include the vesiculoviruses, which are transmitted by either mosquitoes or sandflies. Vesicular stomatitis virus and Chandipura viruses are the common examples.

### Life Cycle

The life cycle of the arboviruses is characterized by their ability to multiply in both the vertebrate hosts and blood-sucking arthropods. Nevertheless, for effective transmission to vectors, the virus must be present in sufficiently higher number in the blood stream of the vertebrate hosts, which can be taken up in small volume of blood ingested during bite of the arthropod. After ingestion, the virus replicates in the gut of arthropods and then spreads to other organs including the salivary gland.

Only the females of the species serve as the vector of the virus, because female species require blood meal for production of the progeny. Most of these viruses in their life cycle show an *extrinsic incubation period* in the vectors, during which viruses are replicated sufficiently in the vector and are present in sufficient numbers in the saliva to transmit infection to the vertebrate host. The extrinsic period for most of the viruses ranges from 7 to 14 days. Some arboviruses are transmitted by vertical transmission through transovarial passage from a mother tick to baby ticks.

### Key Points

Humans in transmission cycle of arboviruses are usually the dead-end hosts.

- Usually human-to-human transmission of infection by the arthropods does not take place due to very low titer of viruses present in the human blood.
- In some diseases, such as dengue and yellow fever, there is a very high titer of viruses in the blood; hence they act as reservoir of infection of other humans.

Disease caused by arboviruses occurs primarily in dead-end host, but neither in the arthropod vector nor in the vertebrate animal that act as the natural host. For example, after infection yellow fever virus causes disease in humans, who are a

dead-end host, but causes a harmless infection among the jungle monkeys in South Africa, which serve as the natural host for yellow fever virus.

### Clinical Syndromes

Arboviruses cause diseases in humans, which may be one of the following clinical syndromes:

1. Fever with or without maculopapular rash.
2. Encephalitis, often with high mortality.
3. Hemorrhagic fever, also frequently severe and fatal.

However, there are some arboviruses that can cause more than one syndrome in the infected human host, e.g., dengue virus. Recovery from the disease usually confers a lifelong immunity.

### Epidemiology

Arbovirus infection occurs in distinct geographical distribution and vector patterns. The viruses occur in tropics as well as in temperate countries. They show a tendency to cause sudden outbreak of disease that usually occurs in the adjoining areas between human dwellings in jungle or forest areas.

### Control

Control methods essentially include vector controls and vaccination. The vaccination has been effective only in yellow fever and a few other diseases but not in most of arboviral diseases. Hence, vector control continues to be a mainstay in prevention of arboviral diseases.

### Roboviruses

A new group of viruses called *roboviruses* has been described recently. This is an acronym for *rodent-borne viral disease*, which is transmitted from rodents to rodents and directly from rodents to humans without participation of arthropod vectors. Transmission occurs by direct contact with body fluids or excreta of rodents. Hantavirus infection, Lassa fever, and South American hemorrhagic fever are the major rodent-borne viral diseases worldwide. The properties of roboviruses are summarized in Box 65-1.

### Togaviruses

Togaviruses are the largest family of arboviruses and contains two genera: *Alphavirus* and *Rubivirus*. The genus *Alphavirus* includes 32 different viruses of which at least 13 viruses are associated with human diseases. They are transmitted mainly by mosquitoes. The genus *Rubivirus* contains rubella virus that causes rubella, which is not arthropod-borne. Togaviruses are classified as follows:

### Box 65-1 Important properties of Roboviruses

1. Spherical, 90 nm in diameter.
2. Single-stranded RNA, linear, nonsegmented, negative-sense, 8.9 kb, MW 3 million Da.
3. Six structural proteins.
4. Enveloped.
5. Replicate in nucleus.
6. Broad host range.
7. Neurotropic.
8. Cause neurobehavioral abnormalities.

1. Alphaviruses
  - A. Encephalitis group
    - (a) Western equine encephalitis
    - (b) Eastern equine encephalitis
    - (c) Venezuelan equine encephalitis
  - B. Febrile illness group
    - (a) Chikungunya virus
    - (b) O'nyong-nyong virus
    - (c) Semliki forest virus
    - (d) Sindbis virus
    - (e) Ross river virus
2. Rubivirus
  - A. Rubella virus

## Alphaviruses

Alphaviruses are mosquito-borne arboviruses, which can be classified as febrile illness group and encephalitis group. The febrile group includes chikungunya virus, O'nyong-nyong virus, Semliki Forest virus, Sindbis virus, and Ross River virus. The encephalitis group includes Western equine encephalitis virus, Eastern equine encephalitis virus, and Venezuelan equine encephalitis virus.

### ▶ Encephalitis group

Encephalitis is an acute inflammation of the brain parenchyma often with secondary meningeal involvement. Western equine encephalitis, eastern equine encephalitis, and Venezuelan encephalitis are the alphaviruses that are associated with encephalitis.

**Western equine encephalitis virus:** This virus causes disease more frequently than the eastern equine encephalitis virus, but the infection is less severe. It is a neuropathic *Alphavirus*, which causes encephalitis and viral symptoms with an associated rash. The virus is spread primarily by the vector mosquito *Culex tarsalis*. The condition is most commonly seen in the United States and is subclinical. The isolation of the virus from the cerebrospinal fluid (CSF) or demonstration of rise in specific antibody titer in the serum confirms the diagnosis. No antiviral therapy is available. A killed vaccine is available to protect horses but not humans.

**Eastern equine encephalitis virus:** Eastern equine encephalitis virus is one of the alphaviruses that causes most severe

disease and is associated with highest fatality. The virus is transmitted primarily by *Culiseta* mosquito. Wild boars are the reservoir host, and horses and humans are the dead-end hosts. The diagnosis is made by isolating the virus or demonstrating a rise in antibody titer in the serum. There is no antiviral therapy. There is a killed virus vaccine for horses, but not for humans.

**Venezuelan equine encephalitis:** This virus is transmitted primarily by *Culex* and *Culiseta* mosquitoes. The condition that manifests as a mild systemic infection and may lead to encephalitis is prevalent in North and South America. Birds are the reservoir hosts.

### ▶ Febrile illness group

**Chikungunya virus:** Chikungunya virus was first described in humans and *Aedes aegypti* mosquito from Tanzania in 1954. The name *chikungunya* means “doubled up”, which describes the clinical manifestation in which patient lies doubled up due to severe joint pains. The disease is transmitted primarily by *A. aegypti* mosquitoes. Humans are dead-end hosts and no animal reservoirs are seen. The virus causes a severe disease with a sudden onset of fever, frequent joint pains, lymphadenopathy, and conjunctivitis. Fever typically is biphasic with a period of remission after 1–6 days. The condition is often associated with maculopapular rash. Hemorrhagic lesions were also observed in the patients in Kolkata during 1963.

Chikungunya virus was first demonstrated in India in 1963 during extensive epidemic caused by the virus in Kolkata, Chennai, and other areas. Outbreaks of Chikungunya have also been documented at regular intervals along the east coast of India and in Maharashtra till 1960s. In 2006, an outbreak occurred in India with 2500 cases reported. About 70% cases were from Andhra Pradesh and Maharashtra. But often there are no outbreaks. No antiviral therapy or vaccine is available.

**O'nyong-nyong virus:** This virus is restricted to Africa and was first reported from Uganda. The virus, closely related to Chikungunya virus antigenically, is transmitted by *Anopheles* mosquito.

**Semliki forest virus:** This virus is yet to be associated with any human disease, although serum antibodies against this virus have been demonstrated in African population.

**Sindbis virus:** Sindbis virus was first reported from *Culex* mosquito in Egypt in 1952. Since then the virus has been reported from other parts of Africa, Philippines, and Australia. Serological evidence of Sindbis virus by demonstration of antibodies in the serum has been demonstrated in India.

**Ross river virus:** The virus has been associated with epidemic polyarthritides in Australia.

## Rubivirus

### ▶ Rubella virus

Rubella is not transmitted by any arthropod vector. Rubella virus is described in detail in Chapter 70.

## Flaviviruses

Flaviviruses were originally named as group B arboviruses. They are similar to togaviruses in that they are also single-stranded RNA viruses and have an icosahedral nucleocapsid surrounded by an envelope. They are slightly smaller (40–50 nm in diameter) than those of an *Alphavirus*, and the RNA does not have a polyadenylate sequence. The virus also lacks a conspicuous capsid structure in the virion. All flaviviruses are serologically related, and antibodies to one virus cross-react with another virus.

The genus flavivirus contains more than 70 viruses, of which nearly 13 viruses can cause infection in humans. Most of these infections are transmitted either by mosquitoes or by ticks. However, hepatitis C virus is transmitted neither by mosquitoes nor by ticks. The flaviviruses causing infections in humans are classified as follows:

1. Mosquito-borne flaviviruses
  - A. Encephalitis viruses
    - (a) St. Louis encephalitis virus
    - (b) Ilheus virus
    - (c) West Nile virus
    - (d) Murray Valley encephalitis virus
    - (e) Japanese encephalitis virus
  - B. Yellow fever virus
  - C. Dengue virus
2. Tick-borne flaviviruses
  - A. Tick-borne encephalitis viruses
    - (a) Russian spring-summer encephalitis virus
    - (b) Powassan virus
  - B. Tick-borne hemorrhagic fever viruses
    - (a) Kyasanur forest disease
    - (b) Omsk hemorrhagic fever
  - C. Hepatitis C virus

## Mosquito-Borne Flaviviruses

### ▶ Encephalitis viruses

**St. Louis encephalitis virus:** St. Louis encephalitis virus is the most important mosquito-borne viral disease in the United States. It is transmitted by *Culex* mosquitoes. Wild birds, such as English sparrows, are the reservoir hosts. Humans are the dead-end host. These viruses are mostly seen in urban areas because these mosquitoes breed in stagnant waste water. The virus causes encephalitis, which is associated with a mortality rate of 10%. Isolation of the virus is difficult; hence diagnosis is mostly based on serology. No antiviral therapy or vaccine is available.

**Ilheus virus:** The virus occurs mostly in South and Central America. The infection is maintained in forests by bats and mosquitoes. The virus usually causes asymptomatic infection and rarely causes encephalitis.

**West Nile virus:** West Nile virus causes encephalitis. The virus is endemic in the Middle East, Africa, and Asia. Wild birds are the main reservoirs of the virus. The infection is transmitted

from wild birds to humans by *Culex*, *Aedes*, and *Anopheles* mosquitoes. Humans are the dead-end hosts. The virus first causes asymptomatic or symptomatic illness in the wild migratory birds. These infected birds contain high titer of the viruses and remain viremic for 1–2 weeks. These serve as important reservoirs of infection for transmission to humans, horses, dogs, and other small animals after being bitten by mosquitoes.

The virus like other arthropod-borne viruses causes viremia, crosses blood–brain barrier, and infects the brain parenchyma causing viral encephalitis. Patients with this virus may present with features of encephalitis, aseptic meningitis, or both. This condition has also been reported from India, and the virus has been isolated from *Culex* mosquitoes. The virus has been isolated from the brain of these fatal cases of encephalitis in Karnataka in 1980–1981. Mental confusion and disorientation with decreased consciousness are some of the manifestations of patients with encephalitis. The infection usually occurs in summer months when humans, mosquitoes, and wild migratory birds remain in close proximity outdoors.

Laboratory diagnosis of the condition is made by isolation of the virus from blood within the first 2 weeks of infection; the virus cannot be isolated from CSF. Enzyme immunoassay and plaque reduction utilization test are available for the specific diagnosis of the condition by demonstration of specific antibodies in serum. A fourfold or greater rise of antibody titers between acute and convalescent titer is diagnostic of the infection. Polymerase chain reaction (PCR) is also available. No antiviral therapy or vaccine for the virus is available.

This is an infection that can be transmitted by transfusion of contaminated blood. Hence, PCR and nucleic acid probes specific for the virus are used to screen the blood for the virus.

**Murray Valley encephalitis virus:** This virus is endemic in New Guinea and Australia. The virus occurs in enzootic cycle involving mosquitoes and wild birds. *Culex annulirostris* is the main vector. The virus was first reported during an epidemic of encephalitis in Murray River Valley in 1951, and hence was called Murray Valley encephalitis virus.

**Japanese encephalitis virus:** JE virus is a flavivirus, which causes JE, the most common cause of epidemic encephalitis. JE virus is a single-stranded RNA virus closely related to St. Louis encephalitis and West Nile virus. The virus was first isolated in Japan during an epidemic of encephalitis in 1935. The virus initially was called Japanese B encephalitis to distinguish it from the Japanese A encephalitis virus (Wang Economs type A encephalitis), which had different epidemiological properties. In India, the virus was first reported in 1955, during an outbreak of encephalitis in Tamil Nadu.

Birds and pigs are two main reservoir hosts. JE is transmitted to humans by certain species of *Culex* mosquitoes widely prevalent in rice fields in Asia. The disease is spread throughout mostly in rural areas of Asia by culicine mosquitoes, most often *Culex tritaeniorhynchus*. Natural infection occurs in Ardeid birds, such as herons and egrets, and the virus is transmitted from bird to bird by *C. tritaeniorhynchus*.

## Key Points

- Birds act as a reservoir host from which the virus is transmitted to humans through several species of culicine mosquitoes.
- Pigs are usually the amplifier host.
- Humans, cattle, buffaloes, and pigs are the vertebrate hosts. *C. tritaeniorhynchus* is a major vector that has predilection for cattle and bites them in preference to humans or pigs, but since the cattle does not develop viremia, this does not contribute to the spread of the disease. The high cattle to pig ratio in India is a major factor that has been suggested to control infection in India.

The bite of infected mosquitoes transmits JE virus to humans. The virus initially replicates at the site of the bite and in the regional lymph nodes. Subsequently, the virus spreads through circulation, causing viremia and leading to inflammatory changes in the reticuloendothelial system, heart, lungs, and liver. Usually, most infections are cleared before the virus infects the central nervous system (CNS) causing subclinical disease. However, neurological invasion can also occur possibly by growth of the virus across vascular endothelial cells, thereby affecting the large parts of brain including the thalamus, basal ganglia, brain stem, cerebellum, hippocampus, and cerebral cortex.

Circulating antibodies play an important role in conferring heterologous immunity against JE.

Most of the infections are asymptomatic. Only 1 in 250 infections results in symptomatic disease. Most symptomatic infections occur in young children between 2 and 10 years and in elderly people in endemic areas. In nonendemic areas, the infection occurs in all the age groups.

Incubation period of JE varies from 4 to 15 days. The condition has an abrupt onset with appearance of symptoms, which include fever, headache, nausea, diarrhea, vomiting, and myalgia, which may last for several days. This is followed by altered state of consciousness, tremors, incoordination, and convulsions. Seizures develop in two-thirds of people—most often in children, while headache and meningismus are more common in adults.

Mortality rate is high; in less-developed areas with poor medical care, the mortality rate may exceed 35%. More than 10,000 reported deaths occur per year due to JE worldwide. The neurological sequelae are severe and can occur in many patients who suffer from the disease. The neurological sequelae include seizure disorder, movement disorder, or motor or cranial nerve paralysis.

JE is a seasonal disease with most cases occurring in temperate areas from June to September. In subtropical areas, transmission begins as early as March and extends until October. Transmission may occur earlier in some subtropical areas, such as Indonesia. Approximately, 35,000–50,000 symptomatic cases are reported per year worldwide, although this is slightly an underestimation of the true incidence of the disease. Approximately 3 billion people currently live in areas endemic for JE, which extend from India to Maritime, Siberia, and Japan.

The disease occurs throughout Asia, but is most prevalent in Southeast Asia.

JE in India was first reported from Vellore, Tamil Nadu, and Pondicherry in 1950s. Since then the condition has been reported in all the states and union territories of India. An estimated 378 million people are living at the risk of JE in 12 states, union territories that are frequently affected. Several outbreaks of JE have occurred in Bankura and Burdwan in West Bengal, Dibrugarh in Assam, South Arcot in Tamil Nadu, Kolar in Karnataka, various areas in Andhra Pradesh, and in Pondicherry, and Gorakhpur in Uttar Pradesh. Rapid agricultural development and intensive rice cultivation supported by irrigation systems facilitating breeding of culicine mosquitoes is primarily responsible for the spread of the condition to newer areas in India. An epidemic of JE virus occurred in Uttar Pradesh and Bihar in India in 2005 and also throughout Nepal. During this epidemic, more than 5000 cases were reported and approximately 1000 deaths were documented.

*C. tritaeniorhynchus* is the most important mosquito species that transmits JE. This mosquito has a peculiar habit to bite outdoors and is extremely active in the evening and night. These mosquitoes breed in collection of water, typically rice fields, thereby increasing the risk of infections in rural areas. Low-grade, short-term viremia occurs in humans and other mammals; hence these are dead-end hosts for the virus. Pigs are the amplifying hosts, because they have persistent, high-grade viremia and help in transmission of the virus in humans living close to the pig-rearing areas.

Laboratory diagnosis of JE is made by isolating the virus from the blood during the first week of illness. The CSF rarely yields virus except in severe or fatal cases. Serodiagnosis is made by using ELISA for demonstration of IgM antibodies in serum or CSF (Fig. 65-1). This test has a high sensitivity, nearing 100%. The test may show false-positive reaction with serum from other febrile illnesses, such as dengue and West Nile fever or with the serum collected after vaccination with yellow fever and JE. The IgM antibodies are present in serum or CSF in approximately three-fourths of patients within the first 4 days after onset of illness and in nearly all the patients after 7 days of illness. Direct fluorescent antibody test is a

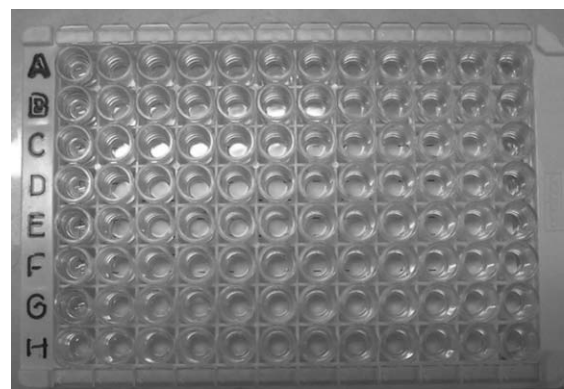

FIG. 65-1. IgM ELISA for serodiagnosis of Japanese encephalitis.

rapid method for detection of viral antigen directly in the brain tissue. Reverse transcriptase polymerase chain reaction (RT-PCR) is used to demonstrate viral genome in the CSF and blood for diagnosis of JE.

There is no specific antiviral therapy available for treatment of JE. Prevention consists of the use of inactivated mouse-brain-derived vaccine using the Nakayama strain. Mosquito eradication and measures to prevent mosquito bite, such as use of mosquito nets, mosquito repellants, and insecticides are useful to prevent transmission of infection.

## Vaccines

### Inactivated mouse-brain-derived vaccine using the Nakayama strain:

- The vaccine is approximately 100% immunogenic after three doses. Two doses of the vaccine are administered at 2 weeks' interval followed by a booster dose after 6–12 months.
- The vaccine is recommended for persons living in epidemic and endemic areas and for travelers planning to visit these areas.
- Vaccine is also useful in pig population to prevent epidemics.

## ► Yellow fever virus

Yellow fever is a mosquito-borne acute febrile illness that occurs in Africa and South America. The disease is not reported in India. Yellow fever virus is the type-specific virus of the family Flaviviridae. It is a single-stranded, enveloped, RNA virus. The envelope consists of a lipid bilayer containing an envelope glycoprotein and a matrix protein. The single RNA is complexed with a capsid protein.

Yellow fever is transmitted by the bite of *Aedes* mosquito. During blood meal, the mosquito deposits the saliva containing the virus into a bite wound. The virus replicates locally and in regional lymph nodes draining the wound. Subsequently, the virus spreads by blood to the bone marrow, liver, myocardium, spleen where further replication of virus occurs. The condition is associated with hemorrhagic manifestations occurring as a result of disseminated intravascular coagulation. This occurs due to bleeding from the gastrointestinal mucosa and from abdominal and pleural serous layers. This is associated with reduction in the synthesis of coagulation factor and altered platelet function. The condition progresses to shock and finally death due to multiple organ failure involving liver, kidney, brain, and heart.

Host immunity is characterized by the presence of viral neutralizing antibodies by the end of the first week during which the virus is rapidly cleared from the circulation. The role of immunity in the pathogenesis of the disease is not known. An attack of yellow fever confers a lifelong immunity.

Incubation period is short and varies from 3 to 6 days. No prodromal symptoms occur.

As the name suggests, yellow fever is characterized by jaundice and fever. This is an illness characterized by an acute onset of fever followed by jaundice within 2 weeks of onset of symptoms. Typically, symptoms begin suddenly with fever, chill, malaise, prostration, headache, giddiness, myalgia, anorexia,

nausea, and vomiting. This may be associated with bleeding from the nose, gums, gastrointestinal tract, or skin that usually occurs within a few weeks of illness. Hemorrhagic diathesis progressing to disseminated intravascular coagulation is the most important complication of the disease. Multiple organ failure involving liver, kidney, and heart is responsible for death of the patient. Yellow fever is a severe and life-threatening disease.

The yellow fever is endemic in South America and in the Caribbean enzootic countries of Africa. Although yellow fever can be transmitted in Asian countries, till now no documented transmission of yellow fever has been reported from Asian countries including India. It has been suggested that previous infection with another flavivirus, such as dengue virus, may confer protection from yellow fever virus. This is the reason suggested for the absence of yellow fever in Asian countries including India. Yellow fever shows following transmission cycles:

**Jungle (sylvatic) cycle:** In this cycle, the mosquito transmits the virus to wild, nonhuman primates; from these hosts, it is transmitted to another mosquito. Humans are the incidental hosts in the cycle. This sylvatic cycle is present in rain forests, and the humans, such as men clearing the trees in the forest are bitten by the mosquito. *Aedes* species are the main vectors in Africa. Wild *Aedes* species are the vectors in South America.

**Urban cycle:** This cycle is confined to urban areas in which the mosquitoes transmit the virus to a human host and then it is transmitted to another mosquito. *A. aegypti*, a domestic mosquito, is the primary vector.

**Intermediate cycle:** This cycle is confined to Savanna forest area of Africa and is the most common cycle responsible for outbreaks of yellow fever in Africa. In this cycle, the mosquito transmits the virus to wild nonhuman primates and human hosts and then it is transmitted to another mosquito.

The yellow fever is transmitted from infected humans to mosquitoes, which are diurnal feeders. Humans suffering from the disease during initial 3–4 weeks of illness are the source of infection. The extrinsic incubation period is 12–21 days. Vertical transmission of yellow fever takes place from female mosquitoes to the female progeny in 1% of cases. This is the important reason for the survival of the virus in dry season. Approximately, 3–10 variants are necessary to infect a mosquito. Seasonal transmission of yellow fever occurs during mid-rainy season and early dry season in Africa. In South America, this occurs from January to March. An estimated 200,000 cases of yellow fever occur in Africa and South America, causing 20,000–30,000 deaths annually. Laboratory diagnosis of yellow fever can be made by:

- Isolation of yellow fever virus from the clinical specimens.
- Demonstration of IgM-specific antibodies in the serum or demonstration of fourfold or more rise in serum IgG.
- Detection of yellow fever antigen in tissues by immunohistochemistry
- Detection of viral genomes by PCR, and
- Elevated transaminase and bilirubin levels, which are demonstrated during the toxic stage of illness.

Vaccination is the most widely used preventive measure against yellow fever (refer the box Vaccines). Other preventive measures include mosquito eradication program and personal protective measures. The latter include the use of proper clothings, insect repellants, etc., which avoid being bitten by mosquitoes and thereby exposure to yellow fever virus.

### Vaccines

The 17 D strain of yellow fever virus is a widely used attenuated live virus vaccine. This avirulent 17 D strain vaccine was recovered during the serial passage of a pantropic strain of yellow fever virus through tissue culture. The strain that has lost its capacity to induce viscerotropic or neurotropic disease has been used as a vaccine for more than 40 years. The vaccine, which is prepared in eggs and is available as a dried powder, is maintained in cold chain for effective immunization. The vaccine is highly effective. A single dose of vaccine produces neutralizing antibodies—indicator of protection in more than 99% of vaccinated people by 30 days. The vaccine provides immunity mainly for 30–35 years and probably for whole life after a single dose. The vaccine is highly safe, associated with very few side effects.

The vaccine is indicated for (a) all the individuals residing in countries endemic for yellow fever and (b) travelers visiting to the countries South America and Africa.

The vaccine is contraindicated for (a) infants below 9 months, (b) pregnant mothers, and (c) individuals with immune deficiency diseases, such as HIV or persons receiving organ transplantation, etc.

### Dengue virus

Dengue is the most common mosquito-borne arboviral illness caused by dengue virus. The name dengue is derived from a Swahili word *ki-dinga-pepo* meaning a sudden seizure by a Demon. The earliest known documentation of symptoms of dengue-like illness was described in Chinese Encyclopedia during 265 AD. In 1780, Rauss coined the term “break-bone fever” based on description of symptoms reported by patients during Philadelphia epidemics of probably dengue fever. The possible outbreak of dengue fever epidemics were documented sporadically every 10–30 years until World War II. Subsequently, after World War II the dengue fever spread and became worldwide. The first epidemic of dengue hemorrhagic fever was described in 1963 in Manila. In 1979–1980, the first reported outbreak of dengue fever occurred simultaneously in Asia, Africa, and North America.

### Properties of the virus

**Morphology:** Dengue virus is a small, spherical, and enveloped virus. It is a flavivirus having a cubic symmetry and measures 40–50 nm in diameter. It is a single-stranded RNA virus of 11 kb size. It has an icosahedral nucleocapsid and is covered by a lipid envelope. The virus is inactivated by diethyl ether and bile salts, such as sodium deoxycholate.

**Viral replication:** The replication cycle is similar to that of other flaviviruses, such as yellow fever virus.

**Antigenic and genomic properties:** Dengue virus has four distinct closely related serotypes: dengue 1 (DEN-1), dengue 2 (DEN-2), dengue 3 (DEN-3), and dengue 4 (DEN-4). The speciation was done by Albert Sabin in 1944. Each serotype is known to have several different genotypes.

### Pathogenesis and immunity

Humans acquire infection and become infected with the virus by the bite of *Aedes* mosquito vector. The leakage of plasma caused by increased capillary permeability is the major pathophysiological abnormality that occurs in dengue hemorrhagic fever and dengue shock syndrome. Bleeding, which is most important manifestation in patients with dengue hemorrhagic fever, is caused due to capillary fragility and thrombocytopenia, and it manifests by various ways ranging from petechial skin hemorrhages to life-threatening gastrointestinal bleeding.

### Key Points

- Dengue hemorrhagic fever or dengue shock syndrome is seen in most patients who have had prior infection with one or more dengue serotypes.
- It is postulated that prior infection with one or more dengue serotypes causes the development of low levels of neutralizing antibodies as well as high level of non-neutralizing antibodies.

In the same patient on reinfection with another serotype of dengue virus, the virus antibody complexes are formed within a few days of second dengue infection. This results in an increase in viral entry and replication of a higher number of mononuclear cells followed by the release of cytokines, vasoactive mediators, and few coagulants. This phenomenon is called antibody-dependent enhancement and is responsible primarily for the disseminated intravascular coagulation seen in the patients with dengue hemorrhagic fever.

In addition, certain dengue strains particularly of dengue 2 are being considered to be more virulent. This is because more epidemics of dengue hemorrhagic fever have been associated with dengue 2 than with other serotypes.

**Host immunity:** Infection with dengue virus confers lifelong immunity. The immunity is serotype specific. Infection by one serotype does not confer protection against other serotypes. The infection with dengue virus of different serotypes may cause a more severe disease, such as dengue hemorrhagic fever. Although dengue and yellow fever viruses are antigenically related, infection with dengue virus does not result in significant cross-immunity against yellow fever virus.

### Clinical syndromes

The dengue virus causes classic dengue or break-bone fever characterized by fever, muscle and joint pain, lymphadenopathy, and rash. In addition, it also causes dengue hemorrhagic fever, i.e., a much more severe disease than classic dengue fever with a high fatality rate.

**Classic dengue fever:** The incubation period varies from 2 to 7 days. The onset of the disease is sudden, which begins as influenza-like illness manifesting as fever, malaise, cough, and headache. The fever, which may be as high as 41°C, typically begins on the third day and lasts for 5–7 days. The fever is typically biphasic, coinciding with the absence of virus in the blood. A maculopapular rash usually appears on third or fourth day of the illness. The rash lasts for 1–5 days, fading with desquamation. Severe pain in muscles and deep bone pain and joint pain (*break-bone fever*) are characteristic. Enlarged lymph nodes and leukopenia are also seen. Classic dengue fever is a self-limiting disease. It is rarely fatal and has few sequelae and complications. The convalescent phase may last for 2 weeks.

**Dengue hemorrhagic fever:** Dengue hemorrhagic fever is a most severe manifestation of the disease. The initial classic phase of dengue hemorrhagic fever is similar to that of dengue fever and other febrile viral illnesses. But, subsequently, the condition of the patient suddenly worsens with shock and hemorrhage, especially into the gastrointestinal tract and skin. The hemorrhagic manifestations include bleeding from nose or gums, melena, and hematemesis. This condition shows a high fatality rate as high as 10%. It occurs in children with passively acquired maternal antibodies. It may also occur in a person previously infected with a different serotype of the virus, showing non-neutralizing heterologous antibodies in the serum.

**Dengue shock syndrome:** It is the most severe form of the disease caused by dengue virus. This is most commonly seen in untreated cases of dengue hemorrhagic fever. The common symptoms include abdominal pain, vomiting, and restlessness and finally, the patient may die of circulatory failure and shock. When treated, dengue hemorrhagic fever has a mortality rate of 5%; if left untreated, the condition has a mortality rate as high as 50%.

### Epidemiology

Dengue virus is distributed worldwide. Dengue hemorrhagic fever is primarily a disease of children and a leading cause of death in Southeast Asia.

**Geographical distribution:** An estimated 3 billion people living in approximately 110 countries worldwide are at a risk of dengue infection. Every year, approximately 100 million people are infected with dengue worldwide. Dengue hemorrhagic fever occurs in approximately 2.51 lakhs of affected persons.

**Reservoir, source, and transmission of infection:** Humans are reservoirs of the infection. The human host serves as source of viral amplification. Humans are infectious to mosquitoes during viremia for 3–5 days. The infection is transmitted by bite of *A. aegypti* mosquitoes. After feeding, the virus shows an extrinsic incubation period of 10–14 days in the mosquito, before the mosquito becomes infectious. The mosquitoes are vectors as well as sources of viral amplification. *A. aegypti* are small and highly domesticated mosquitoes, which breed on artificial water sources, and they prefer to bite humans typically at the back of the neck and at the ankles.

The initial epidemics of dengue were documented in urban areas, but with recent increase in epidemics of dengue, the condition has spread to suburban and rural areas also. Dengue has been spreading from Southeast Asia to the subtropical and tropical Asian countries, Indian subcontinent including India, Sri Lanka, Malaysia, Philippines, New Guinea, Australia, and several pacific islands.

The first epidemic of dengue hemorrhagic fever was described in Manila, Philippines in 1953. Subsequently, dengue hemorrhagic fever has spread more rapidly with epidemics occurring yearly and major outbreaks occurring every 3 years. Currently, dengue hemorrhagic fever is one of the leading causes of death and hospitalization in children in many Southeast Asian countries.

Unplanned urban development with population explosion and inadequate public health facility, poor vector control, and increased travel to the endemic areas have contributed for spread of dengue worldwide.

Dengue was initially restricted to east coast of India. Subsequently, the virus has affected most parts of India. In India, the first report of dengue included isolation of dengue serotypes 1 and 4 in 1964 followed by serotype 3 in 1968. Since then the reports of dengue have been documented from various parts of the India including Vellore, Pondicherry, Chennai, Mangalore, Kolkata, Assam, Lucknow, Delhi, and Haryana. The higher incidence of dengue has been reported in children younger than 8 years.

An endemic of dengue was reported between September 2001 and January 2002 in Chennai, Tamil Nadu. Nearly 8000 cases were officially identified. Subsequently, a major outbreak of dengue was observed in western India during October 2002 to December 2003. The dengue etiology was confirmed by virological and serological studies.

### Laboratory diagnosis

**Specimens:** Blood collected during first 3–5 days of illness is useful for isolation of virus, and serum is useful for serological tests.

**Isolation of the virus:** Diagnosis of dengue is confirmed by isolation of virus from blood during first 3–5 days of illness. The virus can be isolated in various cell cultures.

**Serodiagnosis:** Serodiagnosis of dengue fever is based on the demonstration of IgM immunoglobulin in a single serum sample or rise in IgG antibodies in paired serum specimens. The IgM capture ELISA (MacELISA) is the most widely used test for demonstration of IgM antibody in the serum. Neutralization test, hemagglutination inhibition, and IgG ELISA are the other serological tests used for diagnosis of the condition.



### Molecular Diagnosis

Recently, an RT-PCR is being used for genomic detection of dengue virus in the clinical specimen, but the test is now restricted only for use in research laboratories.

### Treatment

No specific antiviral treatment is available to treat dengue infection.

### Prevention and control

No vaccine is available for prevention of dengue infection. The preventive measures are based mostly on mosquito-control activities. These include the use of insecticides and clearing the stagnant water and artificial collections of water that serve as breeding ground for the mosquitoes. Personal control measures include wearing good protective clothings and use of mosquito nets, mosquito repellants, etc.

## Tick-Borne Flaviviruses

### ▶ Tick-borne encephalitis viruses

**Russian spring–summer encephalitis:** Russian spring–summer encephalitis virus is transmitted by the bite of ixodid ticks. This condition, prevalent in Central Europe, Eastern Europe, and Russia, is transmitted mainly by the bite of ticks. Transovarial transmission of the virus takes place in ticks and makes it an important reservoir host. Wild rodents and birds are the other reservoirs. Ingestion of infected meat obtained from infected goats may also transmit the infection to humans. Avoidance of tick bite is an important control measure. A formalin-treated Russian spring–summer encephalitis vaccine has also been found to be useful.

**Powassan virus:** Powassan virus is another tick-borne virus causing Powassan encephalitis. This has been reported from Canada and northern United States.

### ▶ Tick-borne hemorrhagic fever

**Kyasanur forest disease:** KFD is an example of tick-borne hemorrhagic fever. This disease is called so, because this was first reported in Kyasanur forest of Karnataka in 1957. The virus was associated with a fatal epizootic, affecting monkeys along with severe illness in some of the villages in the area. The causative virus was isolated from the patients and from dead monkeys.

After an incubation period of 3–7 days, the KFD manifests with a sudden onset of fever associated with headache, vomiting, conjunctivitis, myalgia, and severe prostration. In some of the cases, bleeding through gastrointestinal tract and chest cavity may occur. The condition is associated with a case fatality of 5%.

The infection is mostly transmitted by the bite of the tick *Haemaphysalis spinigera*. The tick also acts as the reservoir host because the virus is transmitted transovarially. The monkeys appear to act as amplifier host, but not reservoir host because monkeys die of the infection.

The KFD is mostly localized in distribution and confined to Shimoga district of Karnataka. The disease remained restricted to north Karnataka between 1972 and 1975. Subsequently, the outbreaks of the disease were reported in Velthabelthangadi

in South Karnataka between December 1982 and May 1983. During this outbreak, a total of 1142 human cases were reported with 104 deaths.

No specific antiviral treatment is available. Prevention of the disease is based primarily on control of ticks and personal protection by using adequate clothings and insect repellants. A killed KFD vaccine is also available for use against the KFD.

**Omsk hemorrhagic fever:** This fever is caused by a virus related to KFD. The condition is transmitted by bites of *Dermacentor* ticks and it occurs in Russia and Romania. Clinical manifestations of the disease are similar to that of KFD.

### ▶ Hepatitis C virus

The virus is not an arbovirus hence has been described in detail in Chapter 66.

## Bunyaviridae Viruses

Bunyaviridae viruses are large, spherical (80–120 nm in diameter), and have a triple-segmented and a single-stranded RNA. They have a helical nucleocapsid surrounded by an envelope. They replicate in the cytoplasm, and the assembly of the virion occurs by budding on smooth membrane of the Golgi system. Bunyaviridae viruses consist of more than 200 viruses. On the basis of structural and biochemical properties, they are classified into four genera: *Bunyavirus*, *Hantavirus*, *Nairovirus*, and *Phlebovirus*. All these viruses, with the exception of hantaviruses, are arboviruses that are transmitted by mosquitoes, ticks, and flies. The hantaviruses, however, are transmitted by rodents.

Genus *Bunyavirus* includes more than 150 members including La Crosse virus, California encephalitis virus, and Chittor virus. These three viruses are related antigenically and produce similar clinical diseases. These viral infections are transmitted by mosquitoes.

Hantaviruses are spherical viruses measuring 90–120 nm in diameter. They include Hantann virus (Korean hemorrhagic fever), Seoul virus, and Sin Nombre virus. All these viruses cause hemorrhagic fever with nephropathy. These viruses are transmitted by close contact with rodents, such as mice and rats, and not by arthropod vectors. Transmission of infection occurs by inhalation of aerosolized excreta of the rodents.

A newly identified hantavirus, the Sin Nombre virus, is the causative agent of the hantavirus pulmonary syndrome, which was first identified in the United States in 1993. The infection is acquired by inhalation of aerosols of rodent excreta. No arthropods are responsible for the transmission of the disease.

Genus *Nairovirus* includes six members consisting of Nairobi sheep disease virus and Crimean–Congo hemorrhagic fever. All these viruses are transmitted by *Haemaphysalis* ticks. Nairoviruses are primarily pathogenic for sheep. They cause infection in sheep and are responsible for mortality and morbidity, thereby causing severe economical loss for the farmers. Crimean–Congo hemorrhagic fever virus is the most important *Nairovirus*, which causes Crimean–Congo hemorrhagic fever in



humans. Ganjam virus is a related virus, which causes infection of sheep in India.

Genus *Phlebotomus* includes more than 36 members including sandfly (*Phlebotomus*) fever virus and Rift Valley fever virus. All these viruses are transmitted by different arthropods, such as ticks, sandflies, and mosquitoes.

As the name suggests, the sandfly fever virus is transmitted by female species of sandfly *Phlebotomus papatasi*. The sandfly fever virus has 20 serotypes, of which only five cause human disease. These are Sicilian, Naples, Panta Toro, Chagrss, and Candine. Rift Valley fever virus is a primary pathogen of sheep and other domestic animals. This fever was originally described in Rift Valley, Kenya, and hence was designated as Rift Valley fever. Humans are secondarily infected on contact with infected sheep and other domestic animals. Humans acquire the infection from these reservoir animals through the mosquito bites.

Bunyaviridae virus is surrounded by an envelope which contains two glycoproteins, G1 and G2. The capsule encloses three unique negative RNAs (large, L; medium, M; and small, S) that are associated with proteins to form nucleocapsid. The Bunyaviridae viruses unlike other negative-stranded RNA viruses do not have any matrix protein. They replicate in the cytoplasm of the infected cell in the same way as that of other enveloped and negative-stranded viruses.

Bunyaviridae viruses can infect humans and arthropods. Bite by an arthropod vector, such as mosquito, transmits infection to humans. The virus from the site of infection spreads to the blood causing initial viremia, which may manifest in flu-like symptoms. Further dissemination of the viruses during the phase of secondary viremia may allow the viruses to reach target sites, such as liver, kidney, vascular endothelium, and CNS. In the CNS, many viruses cause neural and glial damage and cerebral edema, leading to encephalitis. Other Bunyaviridae viruses, such as Rift Valley fever virus, may cause hepatic infection, whereas hantana hemorrhagic disease and Crimean–Congo hemorrhagic fever viruses cause hemorrhagic tissue destruction accompanied by hemorrhagic neurosis of the kidney.

Infection by Bunyaviridae viruses leads to development of both the antibody- and cell-mediated immunities. The antibody-mediated immunity may control viremia, whereas the cell-mediated immunity and interferon may prevent further spread of the infection.

Bunyaviruses usually cause a nonspecific febrile flu-like illness that is indistinguishable from illness caused by other viruses. The incubation period is usually short (48 hours), and the fever lasts approximately for 3 days.

California encephalitis virus, La Crosse virus, and Rift Valley fever cause encephalitis. The condition begins with a sudden onset after an incubation period of nearly 1 week. Fever, lethargy, headache, and vomiting are the common symptoms. Seizures usually occur in nearly half of the patients with encephalitis. The condition may be associated with meningitis. The illness lasts for approximately 7 days. The condition is fatal in less than 1% of patients.

The sandfly fever has an incubation period of 3–5 days, after which the patients develop headache, malaise, fever, and nausea, which last for 3–4 days.

Crimean–Congo hemorrhagic fever and Rift Valley fever viruses cause hemorrhagic fever. The condition is characterized by petechial hemorrhage, ecchymosis, hematemesis, and melena. Death occurs in 75% of patients with hemorrhagic manifestations.

The hantavirus typically causes hantavirus pulmonary syndrome, which is more serious disease consisting of prodromal fever and muscle aches. The condition progresses rapidly to interstitial pulmonary edema, respiratory failure, and death within a few days. The hantaviruses cause hemorrhagic fever with renal syndrome. The cases resemble those of leptospirosis and scrub typhus.

Most of the bunyaviruses are distributed in Africa, South America, South-eastern Europe, and southern Asia. The sandfly fever is distributed in Mediterranean countries and central Asia including India. These viruses are transmitted by arthropod vectors, such as mosquitoes, ticks, or *Phlebotomus* flies to rodents, birds, and larger animals, which are the usual reservoirs of infection.

Humans acquire infection from the reservoir animals by arthropod vectors. The arthropods transmit the infection by biting on the skin. *Aedes* mosquitoes are responsible for transmission of California encephalitis virus and La Crosse virus. Flies, such as sandfly transmit Rift Valley fever virus and Sandfly fever virus. Ticks are the vectors for Crimean–Congo hemorrhagic fever.

Hantaviruses are not transmitted by any vectors; humans instead are infected by close contact with rodents or by inhalation of aerosolized rodent urine. The incidence of the disease caused by bunyaviruses correlates well with the distribution of vectors. The disease is more common during summer months.

Serodiagnosis is most important in the laboratory diagnosis of Bunyaviridae virus infection. ELISA for demonstration of serum IgG or IgM antibodies is useful for diagnosis of bunyavirus infections. Demonstration of specific IgM antibody in a single serum or demonstration of a fourfold increase in the IgG antibody titer indicates recent infection. IgM ELISA is used for serodiagnosis of infection caused by hantaviruses. Demonstration of rising titers of hemagglutinating antibodies in paired sera is diagnostic of the disease. The ELISA for demonstration of antigen in the blood is also useful for diagnosis of patients with intense viremia, being observed in Crimean–Congo hemorrhagic fever, hantana hemorrhagic disease with renal syndrome, and Rift Valley fever. Molecular diagnosis is the recent method. The RT-PCR has been used to detect viral genomes in the tissues during the infection caused by the Sin Nombre and Convict Creek hantaviruses.

No specific antiviral therapy is available for bunyavirus infection. Avoidance of close contact of humans with arthropod vectors, such as mosquitoes, ticks, or *Phlebotomus* flies prevents transmission of infection caused by bunyaviruses. Arthropod vector control measures include use of insecticides, wearing protective gloves and clothing, use of net and screens, and control of tick infestation of animals. Control of rodent population minimizes the transmission of infection caused by

TABLE 65-2 Diseases associated with Bunyaviridae

Virus	Disease
Bunyavirus	Encephalitis, aseptic meningitis, and fever
Phlebovirus	Sandfly fever, hemorrhagic fever, encephalitis, and conjunctivitis myositis, rift valley fever
Nairovirus	Crimean–Congo hemorrhagic fever, and Nairobi sheep disease
Hantavirus	Hemorrhagic fever with renal syndrome, adult respiratory distress syndrome, and hantavirus pulmonary syndrome (Sin Nombre virus), shock, pulmonary edema

hantaviruses. Human diseases associated with Bunyaviridae viruses are summarized in Table 65-2.

## Reoviridae

The family Reoviridae consists of four genera (*Orthovirus*, *Coltivirus*, *Orbivirus*, and *Rotavirus*) of which only orbiviruses are transmitted by arthropods. These viruses have double-stranded RNA genome by which they differ from other arboviruses. Colorado tick-borne virus is the only orbivirus, which causes infection in humans. The virus causes Colorado tick fever transmitted by the tick *Dermacentor andersoni*. The virus causes natural infection in rodents. The disease is restricted in its distribution to the western United States. The virus causes a self-limiting disease in humans.

*Kasba*, *Vellore*, and *Palyam* are the arboviruses that have been isolated from mosquitoes in India. Their association with the disease in humans is yet to be ascertained.

## Rhabdoviridae

The genus *Vesiculovirus* of the family Rhabdoviridae consists of Chandipura virus, which has been associated with human infection in India. This is an arthropod-borne virus transmitted by both sandfly and *Aedes* mosquito. The virus was first reported from Nagpur in 1967 from the blood of patients during the epidemic of dengue and chikungunya fever. Their pathogenic role in human disease is not known.

## Ungrouped Arboviruses

### Wanowri Virus

This virus has been isolated from the brain of a girl who died of fever after 2 days in Sri Lanka. The same virus has also been isolated from Hyalomma ticks in India.

### Bhanja Virus

Bhanja virus has been isolated from goats in Ganjam (Odisha) from India. The same virus has been shown to be associated with human infection reported from Yugoslavia.



## CASE STUDY

There was an outbreak of JE in and around Tamil Nadu few years back. As a preventive measure to stop further dissemination of the disease, rural people engaged in pig farming were advised to be away from pig herds and measures were initiated for control of mosquito population.

- What is the basis of advising people to be away from pig population?
- How is JE transmitted in a community?
- What are the laboratory tests used for establishing the diagnosis of JE?
- Is there any vaccine against JE?

# Hepatitis Viruses

## Introduction

Hepatitis is a clinical syndrome caused by many pathogens including viruses. There are six medically important viruses that are called hepatitis viruses because their main site of infection is liver. These viruses are hepatitis A virus (HAV), hepatitis B virus (HBV), hepatitis C virus (HCV), hepatitis D virus (HDV), hepatitis E virus (HEV), and newly described G virus (HGV). Although these viruses infect the liver as common target organ, they however, differ greatly in their morphology, replication pattern, and course of infection. Nomenclature and definitions of different hepatitis viruses, antigens, and antibodies are listed in Table 66-1.

These viruses infect the liver and cause distinct clinical pathology by producing characteristic symptoms of jaundice and production and release of liver enzymes in the serum. Most of these diseases spread very fast because infected individuals are contagious not only during stage of manifestation of the disease but also during the phase of incubation. Human infections associated with hepatitis viruses are summarized in Table 66-2.

## Hepatitis A Virus

Hepatitis A virus (HAV) is a picornavirus that is most commonly transmitted by fecal-oral route. It has a relatively short

incubation period of 3–4 weeks after which jaundice starts suddenly. It is unique in that it does not cause chronic disease or fatal disease.

## Properties of the Virus

### ► Morphology

Hepatitis A virus shows following morphological features:

- It is a typical enterovirus in the family Picornaviridae.
- It is a small, nonenveloped virus measuring 27 nm in diameter (Fig. 66-1).
- It has a single-stranded positive-sense RNA genome. The HAV was originally designated as enterovirus, but it is recognized as a prototype of *Hepatovirus*. The naked capsid is more stable than other picornaviruses to acid and other treatment.

### ► Viral replication

Hepatitis A virus replicates in the cytoplasm of the infected cell. It has a replicative cycle similar to that of other picornaviruses. Briefly, it combines specifically with a receptor expressed on liver cells and few other cells. However, unlike other picornaviruses, it is not cytolytic and is released by exocytosis.

### ► Antigenic and genomic properties

There is only one serotype in HAV. The virus does not show any antigenic relationship with hepatitis B or other hepatitis viruses.

### ► Other properties

Hepatitis A virus is highly resistant to environmental factors. It is stable at 60°C for 1 hour, 56°C for 30 minutes, and 4°C for weeks. It is stable to acidic pH, at pH 1. It is resistant to

**Nomenclature and definitions of hepatitis viruses, antigens, and antibodies**

TABLE 66-1

Virus	Abbreviations	Definition
<b>Hepatitis A</b>	HAV IgM HAVAb	Hepatitis A virus IgM antibody to HAV
<b>Hepatitis B</b>	HBV HBsAg HbcAg HbeAg HBsAb HBcAb HBeAb	Hepatitis B virus Hepatitis B surface antigen Hepatitis B core antigen Hepatitis B e antigen Antibody to HBsAg Antibody to HBcAg Antibody to HBeAg
<b>Hepatitis C</b>	HCV Anti-HCV	Hepatitis C virus Antibody to HCV
<b>Hepatitis D</b>	HDV HDAg	Hepatitis D virus Delta antigen
<b>Hepatitis E</b>	HEV	Hepatitis E virus

**Diseases associated with hepatitis viruses**

TABLE 66-2

Virus	Diseases
HAV	Acute hepatitis
HBV	Acute and chronic hepatitis
HCV	Acute HCV infection, chronic HCV infection, and cirrhosis and other complications
HDV	Acute self-limited infection to acute fulminant liver failure
HEV	Serious infection in pregnant women
HGV	Coinfection in chronic HBV and HCV infection

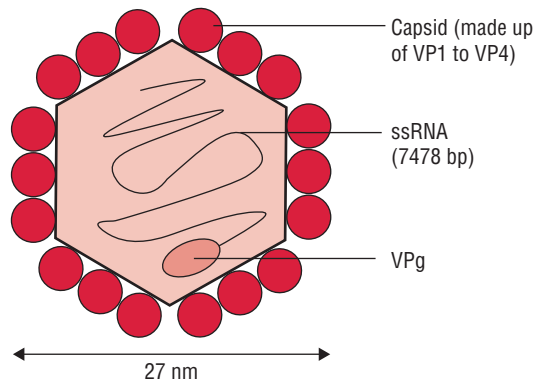

FIG. 66-1. A schematic diagram of hepatitis A virus.

inactivation by lipid solvents, such as ether and chloroform, to action of detergents, and to drying.

The virus is inactivated by formalin (0.35%) at 37°C during a period of 24 hours and by treatment with peracetic acid (2%) for 4 hours and beta-propiolactone (0.25%) for 1 hour. It is also inactivated by exposure to ultraviolet radiation ( $2 \mu\text{W}/\text{cm}^2/\text{minute}$ ). The virus is inactivated by routine chlorine treatment of drinking water.

### Virus Isolation and Animal Susceptibility

Hepatitis A is the only virus that can be grown in human and simian cell culture. However, it is difficult to grow routinely from feces of infected patients.

### Pathogenesis and Immunity

Hepatitis A virus infection is transmitted by the fecal-oral route and is associated with hepatic injury; however, the pathogenesis of HAV infection is not completely understood.

#### ► Pathogenesis of hepatitis A virus infection

The virus appears to replicate first in the gastrointestinal tract and then spreads to the liver (Fig. 66-2). The viruses in the liver infect hepatocytes and cause damage to hepatocytes. But the mechanism by which HAV causes cytopathic effect is not known. Cytotoxic T cells appear to cause damage to hepatocytes; hence once the infection is cleared, the cell damage is repaired and no chronic infection occurs. The classic findings in the hepatocytes include mononuclear infiltrate, ballooning, degeneration, and acidophilic (*Councilman-like*) bodies. The liver pathology caused by HAV cannot be distinguished histologically from that caused by other hepatitis viruses.

#### ► Host immunity

Host immunity is mediated primarily by circulating antibodies. Acute infection is characterized by the appearance of IgM anti-HAV, which is detectable at the time of appearance of jaundice in the initial stage of infection. But the IgM antibody disappears several months after jaundice. The IgG antibody appears 1–3 weeks after appearance of IgM antibodies. IgG antibody appears to provide lifelong immunity against recurrent HAV infection.

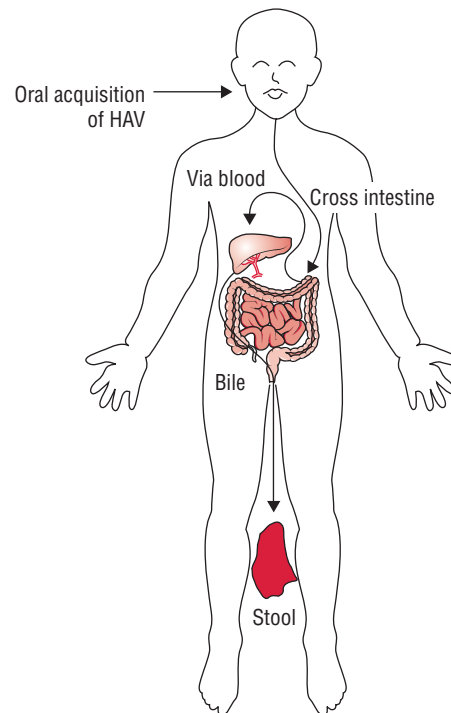

FIG. 66-2. Pathogenesis of hepatitis A virus infection.

### Clinical Syndrome

Hepatitis A virus causes acute hepatitis A, the symptoms of which are similar to those caused by Hepatitis B virus (HBV) infection.

#### ► Acute hepatitis A

The incubation period of HAV is 15–45 days, with an average of 4 weeks. It is relatively short compared to long incubation period of HBV infection. Fatigue, nausea, vomiting, fever, hepatomegaly, jaundice, anorexia, and rash are the most common signs and symptoms of the disease. The condition is also associated with passing of dark-colored urine, pale feces, and elevated serum transaminase levels. Hepatitis A virus infection is usually a self-limiting mild disease and in most cases resolves spontaneously in 2–4 weeks. Hepatitis A virus infection confers lifelong immunity to HAV.

Chronic hepatitis or chronic carrier state does not occur with HAV infection. Hepatitis A virus also never causes hepatocellular carcinoma. Acute hepatitis A is relatively more serious and has high mortality in adults than in children. The exact cause for this is unknown. Acute liver failure and cholestatic hepatitis are some of the rare complications. The mortality caused by HAV is very low, approximately 0.01%.

### Epidemiology

Nearly two-thirds of acute cases of hepatitis are caused by HAV.

#### ► Geographical distribution

Hepatitis A virus infection is common in the developing countries of Asia, Africa, and Central and South America. High prevalence of HAV infection has been documented in the Middle East.

## ► Reservoir, source, and transmission of infection

Humans are the reservoirs for HAV. Humans infected with HAV are the important source of infection. The virus is excreted in the stool during the first 2 weeks of infection, prior to the onset of symptoms; hence the quarantine of patients is not useful. The infected children and adults appear to be noninfectious after the appearance of jaundice.

Contaminated food or water is the main source of infection. Wide outbreak can occur from a single contaminated source, such as uncooked vegetables, infected shellfish, and contaminated food and water (Fig. 66-3).

### Key Points

- Hepatitis A virus infection is transmitted primarily by fecal-oral route.
- Most commonly, the virus spreads from person to person through contaminated water and food including shellfish collected from sewage-contaminated water.
- The virus is rarely transmitted by blood or blood products because the level of viremia in HAV is low and chronic infection does not occur.

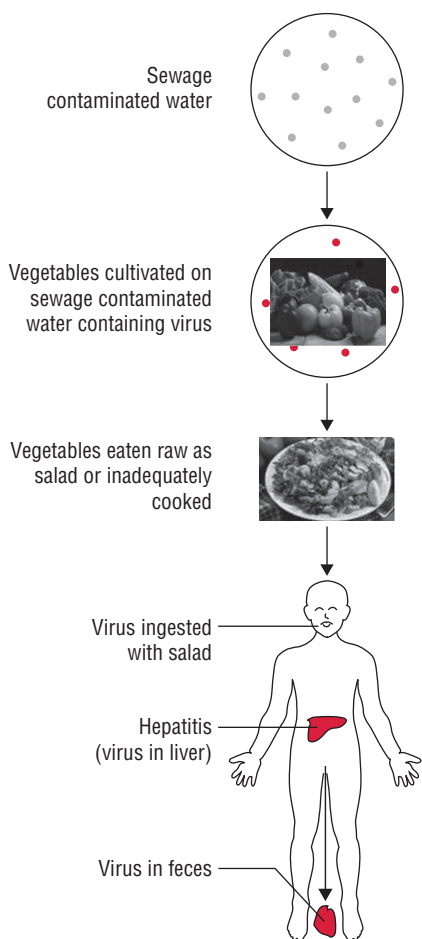

**FIG. 66-3.** Sewage-contaminated vegetables transmitting hepatitis A virus infection.

Infection with HAV occurs throughout the world but is more common in developing countries, in the areas of low socioeconomic status and poor sanitation. International travelers to areas endemic for HAV, drug addicts using injectable drugs, and homosexual men are at high risk for HAV infection. Close contacts of infected individuals are also at high risk. Infection is not transmitted from infected mother to neonates. Secondary infection occurs at a high rate in household contacts of acute HAV (20%).

## Laboratory Diagnosis

### ► Specimens

These include (a) serum for antibody detection test and (b) liver, bile, stool, and blood for HAV antigen and genome.

### ► Direct antigen detection

Hepatitis A virus is present in stools during 2 weeks prior to the onset of jaundice and up to 2 weeks after the onset of jaundice. The virus can be demonstrated in the stool during this period by using immunoelectron microscopy.

### ► Isolation of the virus

Although the virus has been grown in human and simian cell culture, its isolation by culture of feces in the cell line is not routinely done, because the facilities for growing the virus are not widely available.

### ► Serodiagnosis

Serodiagnosis of HAV infection depends on the demonstration of specific antibodies in the serum. Serological tests demonstrating these anti-HAV antibodies in the serum are the most widely used to confirm the diagnosis of HAV infection. Enzyme-linked immunosorbent assay (ELISA) is the method of choice for detection of IgM and IgG antibodies in the serum. IgM antibody is the first antibody to appear at the onset of symptoms and continues to persist at a high level for 1–2 months. It usually disappears by 4–6 months but occasionally persists longer. Hence, demonstration of IgM antibody is diagnostic of a recent infection. IgG antibody appears in the serum shortly after the appearance of IgM antibodies and usually increases as the IgM level decreases. A fourfold rise in IgG antibody titers is also diagnostic of infection.

### Molecular Diagnosis

DNA probes and polymerase chain reaction (PCR) are used to demonstrate HAV genome in stool as well as in the serum of infected patient.

### ► Other tests

Liver function tests are highly useful for supplementing the diagnosis of HAV infection. Hepatitis A virus infection is associated with a consistent increase in serum alanine aminotransferase (ALT) and aspartate aminotransferase (AST).

Increase in ALT and AST levels is nearly 4–100 times more than the normal levels. Increase in serum levels of ALT and AST are usually seen 1 week before. The ALT and AST remain at peak level within 3–10 days after the onset of clinical illness. Serum bilirubin level is also increased, and it increases with the appearance of jaundice. Decrease in serum albumin level and prolongation of prothrombin time indicate a severe hepatocellular infection.

## Treatment

No antiviral therapy is available against HAV infection. Treatment of the condition is always supportive.

## Prevention and Control

Prevention of HAV infection depends on: (a) vaccines, (b) prophylaxis with immune serum globulin, and (c) measures to prevent feco-oral spread of infection.

### Vaccines

Active immunization with vaccines containing formalin-inactivated HAV is available. The vaccine is effective and safe. It is given in two doses, an initial dose followed by a booster dose after 6–12 months. No booster dose is given. Vaccine is recommended for:

- Use in children over 2 years of age,
- Travelers to developing countries,
- Patients with chronic liver disease, and
- Homosexual men.

Another vaccine that contains inactivated HAV and recombinant vaccine is used to immunize against both HAV and HBV.

## Immunoglobulin

Postexposure prophylaxis consists of administration of hepatitis A immunoglobulin to contacts within 2 weeks of exposure. The immunoglobulin is given in a dose of 0.02 mL administered intramuscularly in a single dose. Postexposure prophylaxis is recommended for household contact of infected patients and contact in child-care center during outbreaks.

## Prevention of fecal–oral spread of infection

General prevention measures consist of hand washing, drinking of safe drinking water, and good personal hygiene and sanitation. All these contribute to prevention of fecal–oral spread of infection of HAV.

## Hepatitis B Virus

Hepatitis B virus is a major cause of infectious hepatitis worldwide. It is a hepadnavirus, which shows restricted host range and limited tissue tropism. The virus usually causes chronic disease and is associated with hepatocellular carcinoma. The term serum hepatitis was used after an outbreak of hepatitis among American soldiers in 1942. The cause of outbreak was linked to yellow fever vaccine that was given to the soldiers

which was contaminated by human serum. Blumberg and his colleagues in 1965 described the Australian antigen, which was later called hepatitis B surface antigen (HBsAg). DS Dane in 1970 was first to describe hepatitis B viral particle in human serum by electron microscopy.

## Properties of the Virus

### Morphology

Hepatitis B virus shows following features:

- It is a small (3.2 kb), enveloped DNA virus.
- The genome is a small, circular, partially double-stranded DNA.
- It is partially double stranded, because its positive strand is incomplete. The complete negative strand possesses four genes: genes S, C, P, and X. The gene S codes for HBsAg and also for HBeAg (hepatitis B e antigen).
- Although HBV is a DNA virus, the gene P codes for DNA polymerase that has reverse transcriptase activity. Gene X codes for the X protein that has transcription-regulating activity.
- The virion is a double-walled, spherical structure and measures 42 nm in diameter. It was first demonstrated by Dane in 1970 and so is known as Dane particle. By electron microscopy three types of particles can be seen in the serum from patients with hepatitis B. These are (i) spherical particles measuring 22 nm in diameter, (ii) filamentous or tubular particles with a diameter of 22 nm and of varying length, and (iii) double-walled, spherical structures measuring 42 nm in diameter. The former two particles are antigenically identical and are known as *hepatitis B surface antigen*, or HBsAg. The latter particle is the complete hepatitis viral particle known as *Dane particle* (Fig. 66-4).

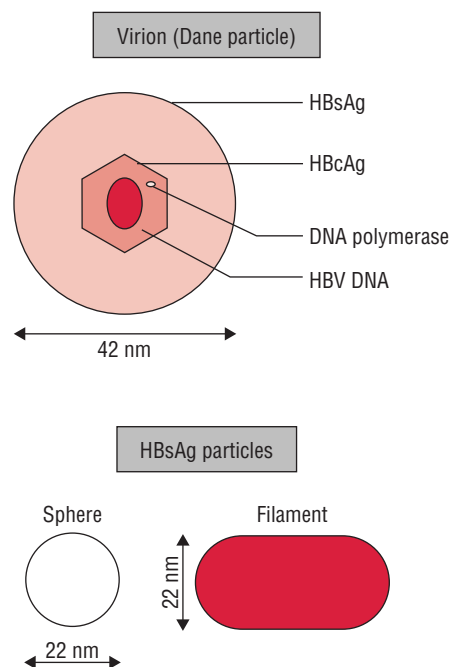

FIG. 66-4. A schematic diagram of Dane particle and hepatitis B surface antigen (HBsAg).

- The HBV consists of nucleocapsid which surrounds HBV DNA and DNA polymerase with reverse transcriptase and ribonuclease activity. The nucleocapsid also encloses a protein attached to genome, which is surrounded by hepatitis B core antigen (HBcAg). The envelope which encloses the virus consists of HBsAg and also HBeAg.

**HBsAg:** This antigen consists of three glycoproteins, namely S, L, and M. These glycoproteins are all encoded by same gene. The S glycoprotein is the major component of HBsAg, which self-associates into 22-nm spherical particles that are released from the cells. The filamentous particles of HBsAg found in the serum contain large amount of S and only small amount of L and M glycoprotein, and other proteins and lipids. The glycoprotein L is essential for virion assembly and for formation of filamentous particles and retention of the structures in the cell.

### ► Viral replication

Hepatitis B virus replication shows many unique features.

- First, the virus shows a well-defined tropism for replication in the liver.
- Second, although a DNA virus, it encodes reverse transcriptase and replicates through RNA intermediates.

The virus replicates in the nucleus of the cell. The virus infects hepatocytes, the attachment of which is mediated by HBsAg glycoprotein. The infection is initiated by the binding of HBsAg to serum albumin and other serum proteins, which subsequently causes the virus to infect the liver. Inside hepatocytes, the partial DNA strand of the genome is converted to covalently closed circular double-stranded DNA. Later on, this genome is transported to the nucleus of the cell.

The DNA acts as a template for all viral transcription including 3.5 kb pregenomic RNA. Subsequently, the genome is enclosed by virus capsular antigen. Within the core, both negative- and positive-strand DNA viruses are synthesized. Finally, the core buds from the membrane, acquiring HBsAg-containing envelope and is released from the infected cell.

### ► Antigenic and genomic properties

HBsAg is antigenically complex. The HBsAg glycoprotein contains a group-specific antigen termed *a* and type-specific antigens termed *d* or *y* and *w* or *r*. Combination of these antigens results in four major subtypes of HBV (*adw*, *adr*, *ayw*, and *ayr*). These subtypes show distinct geographic distributions:

- Subtype *ayw* is common in Asia, Middle East, and western and northern India.
- Subtype *adr* is common in South and East India and in Far East countries.
- Subtype *adw* is prevalent in Europe, Australia, and the Americas.
- Subtype *ayr* is very rare.

A total of eight genotypic variants (genotypes A, B, C, D, E, F, G, and H) of HBV have also been described. The prevalence of different genotypes varies in different countries. The infection

caused by the genotype C is associated with rapid progression of the disease and poor response to antiviral treatment than caused by genotype D.

### ► Other properties

Hepatitis B virus is an extremely resistant virus capable of withstanding extreme temperature and humidity. It is stable when stored at  $-20^{\circ}\text{C}$  for 15 years, at  $-80^{\circ}\text{C}$  for 24 months, at  $44^{\circ}\text{C}$  for 7 days, at  $37^{\circ}\text{C}$  for 60 minutes, and at room temperature for 6 months. HBV, however, is sensitive to higher temperature and is killed rapidly after heating at  $100^{\circ}\text{C}$  for 1 minute and at  $60^{\circ}\text{C}$  for 10 hours.

HBsAg is a stable antigen. It is stable at pH 2.4 for up to 6 hours, but is associated with loss of infectivity of the virus. HBsAg is also destroyed by treatment with 0.5% sodium hypochlorite within 3 minutes. The HBsAg is, however, not destroyed by ultraviolet irradiation of plasma or other blood products, thereby retaining the infectivity of the virus.

## Pathogenesis and Immunity

The pathogenesis and clinical manifestations of hepatitis B infection are primarily due to the interaction of the viruses and host immune system.

### ► Pathogenesis of HBV infection

Hepatitis B virus, after entering the blood, infects the hepatocytes in the liver with the expression of viral antigen on the surface of infected cells. Cytotoxic T cells, such as activated CD4 and CD8 lymphocytes, recognize various HBV-derived proteins present on the surface of hepatocytes resulting in an immunological reaction.

### Key Points

- The virus by itself does not cause any cytopathic effect in the infected liver cells.
- The injury or cytopathic effects most probably occur as a result of cell-mediated injury.
- The formation of antigen-antibody complexes is responsible for some of the symptoms, such as arthralgia, arthritis seen during early stage of the disease.
- The immune complex is also responsible for some of the complications associated with chronic hepatitis, such as immune complex glomerulonephritis, cryoglobulinemia, and vasculitis.
- A restricted T-cell-mediated lymphocyte response occurs against the HBV-infected hepatitis.

A chronic carrier stage with HBV infection is an important event in the pathogenesis of HBV infection. A person with chronic carrier stage has HBsAg persisting in the blood for at least 6 months. This stage is caused by a persistent infection of the hepatocytes that leads to the presence of HBV and HBsAg in the blood. This chronic carrier stage occurs in about 5% of patients with HBV infection in contrast to no chronic carrier stage in patients with HAV infection.

In an infected host whether the person will become a chronic carrier state or will be free of infection depends on the cytotoxic T-cell response. If the cytotoxic T-cell response is strong, the infection is cleared in the person but if the response is inadequate, the person becomes a chronic carrier.

During the chronic stage, the HBV DNA is present in episome in the cytoplasm of persistently infected cells, and in some cells the viral DNA is integrated with cellular DNA. Chronic carrier state is more likely to occur when infection occurs in a newborn than in adult. It has been observed that approximately 90% of the infected neonates become chronic carriers.

Approximately 20% of HBsAg carriers, nearly 1% of all adult patients infected with HBV, and high percentage of neonates infected with the virus progress to develop hepatocellular carcinoma or cirrhosis. The hepatocellular carcinoma appears to be the result of persistent cellular regeneration that tends to replace the dead hepatocytes. Also it is suggested that the integration of HBV DNA with hepatocytes DNA could activate a cellular oncogene, resulting in loss of control of the growth of hepatocytes. However, the HBV genome has no oncogene which can be responsible directly for causing hepatocellular carcinoma.

### ► Host immunity

Hepatitis B virus natural infection induces a lifelong immunity. The immunity is primarily mediated by humoral antibodies against HBsAg. Antibodies to HBsAg are protective. These antibodies bind to surface antigens or with the virus and prevent it from interaction with receptors on the hepatocytes. These antibodies appear to neutralize the infectivity of HBV. But the antibodies against core antigen HBcAg are not protective because the antibodies cannot act with HBcAg present inside the cells.

### Clinical Syndromes

Hepatitis B virus is one of the most important causes of acute and chronic hepatitis. The clinical manifestations vary from subclinical hepatitis to symptomatic and icteric hepatitis. The incubation period varies from 6 weeks to 6 months. The clinical manifestations of HBV infection depend on (a) age of infection, (b) immune status of the host, and (c) the level of HBV.

### ► Acute hepatitis B virus infection

The prodromal or preicteric phase is characterized by gradual onset of anorexia, malaise, and fatigue. During the icteric phase, the liver becomes tender with development of jaundice. Nausea, vomiting, and pruritus with passing of dark-colored urine are the symptoms noted in this stage. Clinical manifestations of acute hepatitis B are similar to that of hepatitis A but with the difference that the symptoms tend to be more severe and life-threatening with HBV infection. The clinical disease associated with acute HBV infection may range from mild disease to a disease as severe as fulminant hepatitis occurring in less than 1% of the patients.

### ► Chronic hepatitis B virus infection

Chronic HBV infection is one of the major complications of HBV infection. The risk of chronic infection is also higher in those infected at birth (90%) and in patients who are immunocompromised. Only 5–10% of older children or adults progress to develop chronic infection.

**Complications of Hepatitis B virus infection:** Cirrhosis and hepatocellular carcinoma are the long-term but rare complications of hepatitis B. Perinatal transmission or infection in children is associated with few or no symptoms, but infection has a high risk of becoming chronic. Fulminant hepatic failure is another major complication of HBV infection. This condition occurs in approximately 0.5–1% of HBV-infected patients. The condition progresses to fulminant hepatic failure with coagulopathy, encephalopathy, and cerebral edema. The case fatality rate of these patients is very high nearing 80%.

Patients with chronic HBV infection have a very high risk of developing hepatocellular carcinoma. The cancer appears to be due to repeated episodes of chronic inflammation and cellular regeneration. The cancer that develops an average of 25–30 years after initial infection is the leading cause of cancer-related deaths in areas where HBV is endemic.

Glomerulonephritis, polyarteritis nodosa, varieties of skin manifestations, cardiopulmonary manifestations, and joint and neurologic manifestations are other important complications of HBV infection.

### Epidemiology

Hepatitis B is a major cause of infectious hepatitis worldwide.

### ► Geographical distribution

Hepatitis B virus is the leading cause of chronic hepatitis, cirrhosis, and hepatocellular carcinoma worldwide. Nearly, one-third of the world population is believed to be infected with HBV. More than 10% of people living in sub-Saharan Africa and in East Asia are infected with HBV. Approximately, 5–10 lakh persons die annually from HBV-related liver disease. An estimated 250,000 persons die from chronic HBV infection every year in the world. Estimates suggest that 400–500 million people worldwide are HBV carriers. The HBV carrier rate varies from 1% to 20% worldwide. This variation is due to difference in the age of infection and in the mode of transmission.

### ► Reservoir, source, and transmission of infection

Individuals with chronic HBV infection are the major reservoir of HBV infections. These people with HBeAg in their serum tend to have high viral titers and thus greater infectivity. Hepatitis B virus is present at a high level in serum. The virions are also present at very low levels in semen, vaginal mucosa, saliva, and tears, and all are infectious. The virus is not detected in urine, stool, or sweat; hence these specimens are not infectious. The hepatitis B virus can be transmitted in the following ways:

**Perinatal transmission:** This is the major route of transmission of the virus worldwide. The transmission occurs from



infected mother to child due to contact with mother's infected blood during the time of delivery as opposed to transplacental passage of the virus. Although HBV is found in breast milk, the role of breast-feeding in transmission is unclear.

**Parenteral transmission:** This transmission occurs due to transfusion of HBV-infected blood and blood products. This was one of the important modes of transmission before 1970s, but with the starting of screening of blood donors for HBsAg, the rate of blood transfusion associated HBV infection has reduced considerably in India and other parts of the world. Patients with hemophilia, renal dialysis, and those receiving organ transplantation and intravenous drug users remain at increased risk of infection. The risk of acquiring HBV among health workers after needle stick injury from infected individuals is estimated to be as high as 5%.

**Sexual transmission of HBV:** Hepatitis B virus is transmitted sexually more easily than Hepatitis C virus (HCV) or Hepatitis D virus (HDV). The infection is associated with vaginal intercourse, genital rectal intercourse, and nongenital intercourse. However, the HBV is not transmitted by hugging and kissing or by sharing towels, eating utensils, or food. Health workers with exposure to infected blood or body fluids, heterosexual persons with multiple partners, household contact, or sexual partners of HBV carriers are other groups at risk.

## Laboratory Diagnosis

Laboratory diagnosis plays an important role to confirm the HBV etiology of hepatitis.

### ► Specimen

Serum is an important specimen because definitive diagnosis of HBV depends on serological testing for HBV infections.

### ► Serodiagnosis

Diagnosis of acute infection is made by demonstration of HBsAg as well as HBeAg in the serum. Both HBsAg and HBeAg are the important serum markers of acute HBV. They indicate viral replication. When viral replication slows, HBeAg disappears and anti-HBeAg is detected. Hepatitis B surface antibody (HBsAb) produced may persist for many years. This is followed by demonstration of IgM antibodies against hepatitis B core antigen (HBcAb).

## Key Points

### HBsAg:

- The antigen appears in blood during incubation period and is detectable in most patients during prodrome and acute phase of the disease.
- Persistent presence of HBsAg in blood for at least 6 months indicates the carrier state and also indicates the risk of chronic hepatitis and hepatic carcinoma. It is not detectable in the serum during convalescent stage. The presence of HBsAg alone does not necessarily indicate replication of complete virion, and the patients may not have symptoms of liver damage.

**HBsAb:** HBsAb is a protective antibody that neutralizes the virus and is usually not detectable during the acute disease since it forms immune complex with HBsAg because it is bound to the large amount of HBsAg present in blood. It is also not detectable in the chronic carrier stage.

**HBcAb:** Demonstration of HBcAb is useful to confirm the diagnosis of HBV infection. Total HBcAb including IgM and IgG antibodies indicates exposure to the virus and viral replication. The HBcAb appears shortly after HBsAg in acute disease and persists for life. Detection of IgM HBcAb is diagnostic of acute HBV infection during window phase. The HBcAb are present in individuals with acute infection, chronic infections, and also in those who have recovered from acute infection. Therefore, the presence of HBcAb IgG does not differentiate between acute and chronic infection. HBcAg is not detectable in the serum, but can be demonstrated in the liver cells by immunofluorescence.

**HBeAg:** HBeAg is present in the blood during the incubation and also during the prodrome and early acute disease. This is also present in certain chronic carriers. The presence of HBeAg indicates a high likelihood of infectivity and transmissibility. Chronic replication of HBV is characterized by the presence of circulating HBsAg, HBeAg usually with HBcAg. Both HBsAg and HBeAg are not present in serum during convalescence. Serum IgG antibodies to HBsAg, HBcAg, and HBeAg appear during the stage of convalescence.

In essence, hepatitis B serology is useful to describe the course and nature of the disease. Acute and chronic HBV infection can be differentiated by the presence of HBsAg and HBeAg in the serum and distribution pattern of the antibodies to the individuals' HBV antigen (Fig. 66-5). Interpretation of common serological markers in HBV infection is summarized in Table 66-3.



### Molecular Diagnosis

Hepatitis B virus DNA and DNA polymerase activity are detectable during the incubation period and early in the disease.

- HBV DNA levels are typically low or absent in inactive carriers.
- HBV DNA levels are higher in patients with chronic hepatitis and are associated with increased infectivity.
- The detection of viral DNA in the serum indicates acute infection.

HBV PCR for demonstration of HBV DNA is highly valuable to monitor the treatment of chronic HBV infection with antiviral therapy. This is also useful to identify HBV as the cause of liver infection in HBsAg-negative patients.

### ► Other tests

These tests include elevation of ALT and AST. High levels are found in acute hepatitis (1000–2000 IU/mL). Estimation of serum bilirubin indicates the intensity of jaundice.

## Treatment

No specific antiviral treatment is available for patients with acute HBV infection. Supportive and symptomatic care continues to

Serum marker	HBeAg	HBsAg	Anti-HBc	Anti-HBs
Resolved	-	-	+	+
Chronic <sup>1</sup>	+	+	+	-
Vaccinated	-	-	-	+

<sup>1</sup>One year after initial infection

The absence of anti-HBs is an indication that the infection has become chronic

The currently used vaccine, containing recombinant hepatitis surface antigen, elicits only anti-HBsAg antibody, which is the neutralizing antibody

FIG. 66-5. Serum markers in hepatitis B infection.

TABLE 66-3

## Interpretation of common serological markers in HBV infection

HBsAg	HbeAg	Viral markers				Interpretation
		HbcAb		Anti-HBs	Anti-HBe	
		IgM	IgG			
+	+	-	-	-	-	Late incubation period or early hepatitis
+	+	+	-	-	-	Acute HBV infection; highly infectious
+	±	-	+	-	-	Late or chronic HBV infection
-	-	-	+	+	+	Past infection
+	-	-	+	-	-	Simple carrier
+	+	-	+	-	-	Super carrier
-	-	-	-	+	-	Immunity following vaccination

be the mainstay of therapy for most of the patients. Therapy is recommended for patients with chronic hepatitis B infection. Interferon and nucleoside analogs, such as lamivudine, adefovir, and telbivudine are the antiviral drugs used widely. These antiviral drugs achieve viral suppression as demonstrated by loss of HBeAg in serum and suppression of HBV DNA.

**Interferons:** Interferon-alpha (IFN- $\alpha$ ) has been the mainstay in treatment of chronic hepatitis B since its introduction in mid-1980s. Interferon acts by immunomodulation and prevents progression of acute hepatitis to chronic stage. It also promotes more rapid resolution of viremia and normalization of serum aminotransferase levels.

**Nucleoside analogs:** These block the replication of viruses by directly blocking the replication of HBV. These nucleoside analogs are highly effective against HBV, and are bioavailable and extremely well targeted. However, neither interferon nor nucleoside analogs cure HBV infection. The goal of antiviral therapy is only to reduce morbidity due to HBV and to prevent complications.

## Prevention and Control

Hepatitis B infection can be prevented by the use of either vaccine or hyperimmunoglobulin or both.

## Vaccines

Hepatitis B infection is one of the major diseases of humans that can be prevented with vaccination. Plasma-derived and recombinant DNA HBV vaccines are the two types of vaccines that use HBsAg to stimulate the production of anti-HBs in noninfected individuals. The vaccines are highly effective with more than 95% of seroconversion. The vaccine for adults is recommended at 0, 1, and 6 months and for infants at the time of birth, at 1–2 months, and at 6–18 months.

- The vaccine is indicated for all infants and for all people who are at high risk of infection.
- The high-risk group includes the people who are frequently exposed to blood and blood products, patients receiving multiple transfusion or dialysis, patients suffering from sexually transmitted disease, and intravenous drug users.

## ► Hepatitis B immunoglobulin

Hepatitis B immunoglobulin (HBIG) is used for passive immunization of patients after or just before the exposure. This immunoglobulin is derived from human plasma and contains high titer of HBsAb. It is prepared from plasma from patients

who have recovered from hepatitis B infection. Passive immunization with HBIG is recommended for:

- people who have a history of recent exposure to patient(s) infected with HBV,
- a household contact with acutely infected patient,
- sexual contact with an acutely infected patient, and
- infants born to HBsAg-positive mother.

Screening of blood and blood products for HBsAg is important to prevent transfusion-related HBsAg.

## Hepatitis C Virus

Hepatitis C virus is a flavivirus with an RNA genome and is the most important cause of parenteral non-A, non-B hepatitis (NANBH) worldwide. Prior to identification of the virus, it was known as NANBH to differentiate it from viral causes of nonalcoholic hepatitis. Most patients infected with HCV have chronic liver disease, which progresses to cirrhosis and hepatocellular carcinoma.

## Properties of the Virus

### ► Morphology

Hepatitis C virus is the only member of the genus *Hepacivirus* in the family Flaviviridae of RNA-containing virus. HCV appears to be closely related to hepatitis D and dengue and yellow fever virus. It resembles flavivirus in structure and organization, and hence has been classified as a new genus *Hepacivirus* in the family Flaviviridae. Hepatitis C virus shows following morphological features:

- It is a spherical, enveloped, 9.4 kb, single-stranded RNA virus with a diameter of 55 nm.
- The genome is approximately 9500 base pairs that encode 10 structural and regulatory proteins. Structural proteins include the core and two envelope proteins, namely, E1 and E2. These two envelope proteins undergo variation during infection due to hypervariable regions within their genes.
- The viruses are ether sensitive and acid sensitive.

### ► Viral replication

These viruses like other flaviviruses replicate in the endoplasmic reticulum of hepatocytes.

### ► Antigenic and genomic properties

Hepatitis C virus shows a considerable degree of genomic variations. There are six major genotypes (genotypes 1–6) and numerous subtypes which differ in their worldwide distribution. Molecular differences between these genotypes are relatively large with as little as 55% genetic sequence homology and more than 80 subtypes are described. This genetic variability is the main stumbling block against the effort to develop an anti-HCV vaccine.

## Key Points

- Genotype 1 is the main HCV genotype prevalent worldwide and accounts for 40–80% of all isolates. It is associated with more severe liver diseases and high risk of hepatocellular carcinoma. HCV genotype 1, particularly 1b as well as genotypes 2 and 3, are usually less responsive to interferon therapy than other HCV genotypes.
- Genotypes 2 and 3 are also found globally, but to a lesser extent.

## Pathogenesis and Immunity

The ability of HCV to remain cell associated and prevent host cell death is the main determinant of viral pathogenicity, which causes persistent infection in the liver. Presence of closely related but heterogeneous population of virus genome is one of the important factors responsible for persistence of HCV infection in the liver.

### ► Pathogenesis of hepatitis C virus infections

Hepatocytes and possibly B lymphocytes are the natural targets of HCV. Results of recent studies show that at least 50% of hepatocytes may be infected with HCV in patients with chronic hepatitis. In most infected people, viremia persists and is associated with a variable degree of hepatic inflammation and fibrosis.

Chronic hepatitis is characterized by lymphocyte infiltration either within the portal tract or in the liver lobule and portal and periportal fibrosis. Portal inflammation, interphase hepatitis, and lobular necrosis are the main histopathological features of chronic hepatitis caused by HCV.

### ► Host immunity

Immunity to HCV may not be lifelong, and serum antibodies to HCV are usually protective. Cell-mediated immunity, mainly cytotoxic T lymphocytes, contributes primarily to liver inflammation and ultimately to tissue necrosis.

## Clinical Syndromes

Hepatitis C virus can cause: (a) acute HCV infection, (b) chronic HCV infection, and (c) cirrhosis and other complications induced by hepatitis. The incubation period of hepatitis C varies from 15 to 60 days with an average period of approximately 8 weeks.

### ► Acute HCV infection

Most patients with acute HCV infections are symptomatic and do not develop any jaundice. The symptoms of acute HCV infection tend to be mild and may appear similar to those of HBV infections. In symptomatic cases, jaundice occurs in less than 25% of acutely infected patients, whereas hepatomegaly is seen in one-third of cases. But most of the cases (80%) are asymptomatic and do not develop any jaundice.

## ► Chronic HCV infection

Hepatitis C virus is a major cause of chronic hepatitis worldwide. Most patients with chronic hepatitis are asymptomatic and may have nonspecific symptoms, such as fatigue or malaise in the absence of hepatic synthesis dysfunction.

## ► Cirrhosis and other complications induced by hepatitis C

Hepatitis C virus is now a leading cause of hepatitis and cirrhosis. An estimated 20% of patients with chronic hepatitis progress to cirrhosis. This process may take an average of 20 years after initial infection worldwide. Patients with this condition have a secondary risk of liver failure, portal hypertension, and other complications.

Hepatocellular carcinoma is one of the most important complications in 1–5% of patients with underlying cirrhosis. This condition usually develops after 30 years in patients who are chronically infected and have cirrhosis. The increased total number of deaths due to HCV-related complications, such as cirrhosis and hepatocellular carcinoma, has been reported from many countries.

## Epidemiology

Hepatitis C is prevalent worldwide.

## ► Geographical distribution

More than 3% of world's population is infected with HCV. Worldwide 170 million people are estimated to be infected with HCV. It is the most important cause of parenteral NANBH worldwide. The prevalence rates are reported to be as high as 22% in Egypt due to use of parenteral antischistosomal therapy. The prevalence rates in healthy blood donors are also equally high. Hepatitis C virus is highly prevalent in central Europe, Middle East, Spain, Italy, and Japan.

## ► Reservoir, source, and transmission of infection

Hepatitis C is exclusively a human disease. Patients who are infected with the virus are the important reservoir of infection. Blood or blood products and also organs of infected patients are the major sources of infection. Hepatitis C can be transmitted by following methods:

**Blood transfusion:** Blood transfusion is the most important route of transmission of HCV. The current risk of transfusion-derived HCV is estimated to be one case in every 100,000 units transfused.

**Parenteral transmission:** HCV is transmitted parenterally (a) through transfusion of infected blood or blood products, (b) transplantation of organs from infected donors, and (c) also by sharing of contaminated needles among intravenous drug users. The use of intravenous drugs is most important risk factor responsible for around 50% of both acute and chronic infections.

**Sexual transmission:** Sexual transmission is believed to be responsible for approximately 20% of cases of hepatitis C. The presence of coexisting sexually transmitted disease, such as HIV, appears to increase the risk of transmission.

**Perinatal transmission:** Perinatal transmission is possible and is observed in fewer than 5% of children born to HCV-infected mothers. The risk of perinatal transmission of HCV is higher in children born to mothers who are coinfecting with HCV and HIV.

**Other methods of transmission:** Hemodialysis, tattooing, body piercing, and acupuncture with unsterile equipments are other, but less frequent, means of transmission of HCV. Needle stick injury among healthcare workers who are exposed to infected blood accounts for nearly 4% of new infections. The possibility of acquiring HCV after needle stick injury involving an infected patient appears to range from 0% to 7%.

## Laboratory Diagnosis

Laboratory diagnosis is most important to establish the specific diagnosis of hepatitis caused by HCV.

## ► Serodiagnosis

Hepatitis C infection can be confirmed by employing serological tests to detect antibodies to HCV. Antibodies are directed against core envelope and NS3 and NS4 proteins and tend to be relatively low in titer. Acute HCV antibodies are usually demonstrated in acute infections 6–8 weeks after initial infection. Then antibodies that are produced persist throughout life in chronic infection.

ELISAs, including second- and third-generation ELISAs, are useful for screening of serum for anti-HCV antibodies. These assays are highly specific but cannot differentiate acute infection from chronic infection. The ELISA which employs antibodies against core proteins and nonstructural proteins 3, 4, and 5 is the most recent third-generation enzyme immunoassay (EIA). The test can detect antibodies in the serum 8 weeks after the onset of infection. Recombinant immunoblot assay using recombinant HCV antigen is a highly specific test to detect HCV infection. This test, which is more specific than the ELISA, has been used to confirm positive ELISA results.



### Molecular Diagnosis

PCR and branched DNA assays are being used to detect HCV RNA in the serum. HCV RNA testing is the most specific test for HCV infection and useful in diagnosing acute HCV infections before antibodies are developed. This is also helpful to (a) assess the HCV genotype, (b) to confirm false-positive cases, such as autoimmune hepatitis, and (c) to predict the response to interferon therapy.

Hepatitis C virus genotyping is a recent method, which is frequently helpful for predicting the likelihood of response and duration of treatment. The genotyping is performed either by direct sequence analysis or restriction fragment length polymorphism.



### Biopsy

Liver biopsy is the most accurate method to evaluate the extent of HCV-related liver disease. It is usually recommended for all patients before the start of antiviral therapy. However, it is generally not used to diagnose HCV.

TABLE 66-4

## Differentiating features of hepatitis A, hepatitis B, and hepatitis C viruses

Feature	Hepatitis A	Hepatitis B	Hepatitis C
<b>Virus</b>			
Diameter	27 nm	42 nm	50–60 nm
Genome	RNA	DNA	RNA
Envelope	Nonenveloped	Enveloped	Enveloped
Mode of infection	Feco-oral	Parenteral	Parenteral
<b>Immunity</b>			
Homologous	Yes	Yes	No
Heterologous	No	No	No
Duration of immunity	Probably lifetime	Probably lifetime	–
<b>Clinical features</b>			
Incubation period (days)	10–50 (short)	50–180 (long)	15–160 (long)
Onset	Acute	Insidious	Insidious
Fever (>38°C)	Common	Less common	Less common
Chronicity	Rare	5–10%	70–90%
Mortality rate (icteric cases)	<0.5%	<1–2%	0.5–1%
Age incidence	Children, young adults	15–29 years, babies	Adults
Seasonal incidence	Peak in autumn	Throughout the year	Throughout the year
<b>Laboratory features</b>			
HBsAg	Absent	Present	Absent
IgM levels	Elevated	Normal to slightly elevated	Normal to slightly elevated
Duration of amino transferase levels	1–3 weeks	1–6+ months	1–6+ months
Virus in feces	Present early	Absent	Absent
Carrier state in blood	Up to 8 months	Up to 5 years	–
Association with hepatocellular carcinoma	No	Low	High

## Treatment

A combination therapy of pegylated interferon and antiviral agent ribavirin is the current option of treatment for patients with chronic HCV infections. Other therapeutic options include the use of protease inhibitors, ribozymes, and viral vaccines.

## Prevention and Control

No vaccine against HCV is available. Immunoglobulin is not useful in preventing transmission and, in fact, administration of immunoglobulin has been associated with HCV. Transmission of HCV can be prevented by screening and preventing donation of blood, organs, or semen from HCV-positive donors. Differentiating features of HAV, HBV, and HCV are summarized in Table 66-4.

## Hepatitis D Virus

Hepatitis D virus is the smallest of known human pathogens that causes infections in humans. It is an RNA virus, which is structurally unrelated to hepatitis A, B, or C virus. Hepatitis D virus is unique in being an incomplete virus and requires the presence of HBV to replicate and infect other hepatocytes. Hence, HDV infection occurs only in those patients who suffer from HBV infection.

Hepatitis D virus was first reported by Rizzetho and colleagues in Italy in 1977. They demonstrated the viral antigen in nuclei of hepatocytes of patients infected with HBV and suggested it to be a new hepatotropic virus delta, or HDV.

Hepatitis D virus is a spherical, enveloped virus measuring 85 nm in diameter. It contains a single-stranded negative-sense 1.7 kb RNA. In blood, HDV or delta agent contains delta Ag (HDAg) surrounded by HBsAg envelope. HBsAg is required for HDV replication, but it may be suppressed to undetectable levels with active HDV replication. The single-stranded RNA is circular and is surrounded by delta-antigen core, which in turn is surrounded by an envelope which contains HBsAg. Delta antigen may occur in two sizes—small (24 kDa) or large (26 kDa). Delta antigen is the only protein coded for HDV RNA, and it is distinct from antigenic determinants of HBV.

## Key Points

- Patient may acquire HDV infection in two ways—by coinfection or superinfection.
- Since both HDV and HBV are transmitted by the same route, a person can be coinfecting with HBV and delta agent at the same time.
- A patient with chronic HBV infection may also be superinfected with delta agent.

Hepatitis D virus causes a more rapid and severe disease with rapid progression in HBV carriers superinfected with delta and HBV. Delta agent replicates in the liver, causing liver damage and cytotoxicity. Chronic HBV carriers superinfected with HDV usually also develop chronic HDV infection. Chronic coinfection often leads to a rapidly progressive subacute or chronic hepatitis, resulting in more rapid progression to cirrhosis. Delta agent causes damage to liver cells as a result of direct cytopathic effect in combination with underlying immunopathology of HBV disease.

Hepatitis D virus causes an acute and chronic inflammatory disease of liver. Although HDV can replicate independently within the hepatocytes, it requires HBsAg for its propagation. Death of hepatocytes in the liver may occur as a result of direct cytotoxic effect of HDV or through a host-mediated immune response.

Hepatitis D virus is distributed worldwide. It is believed to infect approximately 15 million (5%) of world's 300 million HBsAg carriers. The highest prevalence of HDV has been reported in Italy, North Africa, Middle East, West Africa, and central Asia including China, Japan, Taiwan, and Myanmar. The infection is most common among adults and children. It is observed more commonly among patients with history of intravenous drug users.

Hepatitis D virus, like hepatitis B virus, is a blood pathogen and is transmitted mostly by blood and vaginal secretions. It is most commonly transmitted by nonpercutaneous routes, especially by close intimate contact in endemic areas of Mediterranean countries. Infection appears to be more commonly transmitted through contaminated blood and blood products in nonendemic areas of northern Europe and North America. Sharing of contaminated needles in intravenous drug users is believed to be the most common method of transmitting HDV. The sexual and perinatal transmission of HDV is also described. Intravenous drug use and multiple blood transfusions are the important risk factors for parenteral transmission of the disease.

The incubation period varies from 21 to 45 days but may be shorter in cases of superinfection. The clinical course of disease caused by HDV is varied and ranges from acute self-limited infection to acute fulminant liver failure. Clinically, HDV infection is indistinguishable from other forms of viral hepatitis. Patients coinfecting with HBV and HDV show a more severe course of the disease than those infected with HBV alone. Complete clinical recovery and clearance of HBV and HDV coinfection is the most common outcome.

Nearly 1% of the patients with coinfections progress to develop fulminant hepatitis resulting in more rapid progression to cirrhosis. Laboratory diagnosis of HDV infection is usually carried out by serological as well as molecular tests:

- ELISA for HDV antigen is usually positive in 20% of patients.
- IgM ELISA for demonstration of anti-HDV IgM is positive in early stage of infection, whereas IgG ELISA for anti-HDV IgG is positive during later course of infection.
- Serum antibodies against HDAg are almost exclusively associated with chronic HDV infection.
- Reverse transcriptase-PCR (RT-PCR) is the most sensitive method (90%) for detection of HDV RNA in blood in the stage of coinfection.
- In superinfections, high level of both IgM and IgG antibodies as well as high level of HDAg and HDV RNA is demonstrated.

No specific therapy is available for treatment of HDV infection of liver. Lamivudine and ribavirin appear to be ineffective against HBV and HDV coinfection. Antiviral therapy with interferon is also ineffective in patients with chronic infections.

Vaccination with HBV vaccine protects against subsequent HDV infection. HDV virus is prevented best in the patients already infected with HBV by avoiding the use of HDV-contaminated blood or blood products.

## Hepatitis E Virus

Hepatitis E virus (HEV) is the primary cause of enterically transmitted non-A non-B hepatitis virus (NANBH), most commonly seen in developing countries including India. The virus has many similarities with HAV. The virus was first observed during the electron microscopy of feces contaminated with enteric NANBH.

Hepatitis E virus is currently classified in the family Calciviridae. It resembles calciviruses, such as Norwalk virus. However, the HEV genome is different from genome of other calciviruses, and analysis of the genome sequence suggests that it is more similar to rubella virus. Therefore, HEV still remains to be classified.

It is a nonenveloped, spherical virus measuring 32–34 nm in diameter. The surface of the virion shows indentations and spikes. It is icosahedral. The virus contains a positive-sense single-stranded RNA, approximately 7.6 kb in size. The viral genome contains three open reading frames (ORFs). ORF1 is the largest, which codes for nonstructural protein responsible for viral replication. ORF2 encodes for the capsule. The function of ORF3 is not known. The virus is heat stable. The cloning of viral genome showed HEV to consist of only one serotype. In HEV infection, the IgM antibody titer appears first, which falls rapidly after infection, becoming virtually undetectable within 6 months. Anti-HEV IgG, however, persist longer for more than 6 months. The IgG antibody appears to offer protection against reinfection by HEV.

Hepatitis E virus usually causes an acute, self-limiting disease similar to HAV. Earlier it was mistaken for HAV due to clinical and epidemiological similarity. Hepatitis E virus infection, now, has been recognized as a distinct clinical entity, different from the infection caused by HAV. Clinically, HEV infection differs from HAV infection by causing acute disease and by the occurrence of symptoms much later than those of HAV disease.

The incubation period of HEV infection varies from 2 to 9 weeks with an average of 35 days.

Hepatitis E virus causes a serious infection in pregnant women. It causes fulminant disease in pregnant women, especially in last trimester of pregnancy and has a high fatality rate of 15–20%. Encephalopathy and disseminated intravascular

coagulation are the important causes of death. The rate of fulminant hepatic failure in infected pregnant women is very high.

Hepatitis E virus infection does not appear to cause chronic liver diseases.

Infiltration of portal tract by lymphocytes and polymorphonuclear leukocytes, balloon hepatocytes, formation of acidophilic bodies, and intralobular necrosis of hepatocytes is the classic pathological finding of HEV infection.

Hepatitis E virus is distributed worldwide. It is most commonly found in developing countries. The epidemics of HEV have been recorded in India, Pakistan, Nepal, China, Burma, North Africa, and Mexico. During 1986–1988, one such large outbreak was reported in north-east China affecting nearly 10,000 people.

In India, the largest epidemic of HEV occurred in Delhi during the winter of 1955–1956, affecting more than 30,000 persons. Anti-HEV antibodies are observed in serum of as many as 60% of children in India below 5 years of age. Tropical climate, poor sanitation, and poor personal hygiene all contribute to the epidemic of the disease in developing countries.

Hepatitis E virus is transmitted primarily by fecal–oral route due to fecal contamination of water in endemic areas. Fecal contaminated water is the important source of infection. The reservoir of HEV is unknown, but it may be transmitted by animals.

### Key Points

- The virus is yet to be cultured.
- The serodiagnosis of HEV infection is carried out by Western blot and EIAs using antigenic domains from ORF2 and ORF3. Detection of anti-HEV IgM and IgG helps to differentiate acute and chronic infections.
- PCR is also used to detect HEV RNA in serum and stool specimen of infected patients. This test, however, is restricted to few research laboratories.

Treatment of HEV infection is mainly supportive. No vaccine is available now for prevention of HEV. Administration of immunoglobulin does not prevent development of clinical disease. Hepatitis E virus infections respond poorly to

TABLE 66-5

### Epidemiological features of hepatitis viruses

Virus	Mode of transmission	Vaccine	Immunoglobulins
HAV	Fecal–oral	Available	Useful
HBV	Blood, sexual, at birth	Available	Useful
HCV	Blood, sexual	Not available	Not useful
HDV	Blood, sexual	Not available	Not useful
HEV	Fecal–oral	Not available	Not useful

treatment with serum IgG. Epidemiological features of hepatitis viruses are summarized in Table 66-5.

### Hepatitis G Virus

Hepatitis G virus (HGV) is similar to viruses of Flaviviridae family, which includes HCV. The flavivirus-like isolates were first demonstrated in Tamarin monkeys inoculated with blood from a surgeon with acute hepatitis in 1995. A similar virus was isolated from another patient during the same year. These viral isolates were designated GB viruses A, B, and C. A similar virus resembling GBVC (GB virus C) was isolated from a patient with chronic hepatitis in 1996. Now the virus has been designated as HGV.

Hepatitis G virus is an RNA virus and its genome codes for 2900 amino acids. The virus shows 95% homology at the amino acid level with GB virus and GBVC, a previously described virus. HGV has 20% homology with HCV.

Hepatitis G virus is a blood-borne virus, which is transmitted by transfusion of contaminated blood or blood products. HGV coinfection is observed in 6% of chronic HBV infection and in 10% of chronic HCV infection. Although HGV RNA has been demonstrated in patients with acute, chronic, and fulminant hepatitis, patients with multiple transfusions and hemodialysis, blood donors, and intravenous drug addicts, its role in the pathogenesis of hepatitis is yet to be elucidated. Therefore, whether or not HGV is actually a pathogen in humans, still remains to be clarified.



### CASE STUDY

A 25-year-old resident in surgery was admitted to the hospital with jaundice, nausea, and vomiting. His liver is enlarged. The serum test shows elevated aminotransferase. He gave a history of vaccination with hepatitis B vaccine 6 years back. His serum tested for HAV IgM was negative, HAV IgG positive, HBsAg negative, HBsAb positive, HBeAb negative, and HCV-antibody positive.

- What is the possible hepatitis virus responsible for the condition?
- What is the most likely method of acquiring this infection?
- What are the complications of this infection?
- How can you prevent this infection?

# Retroviruses

## Introduction

Retroviruses are enveloped, positive-stranded, spherical RNA viruses showing a characteristic morphology and unusual mode of replication. The presence of an unusual enzyme—the RNA-dependent DNA polymerase or *reverse transcriptase*, giving the virus its name (*retro* meaning reverse)—is the unique feature of the viruses belonging to the family Retroviridae.

The enzyme reverse transcriptase prepares a DNA copy of the retroviral RNA genome—initially RNA–DNA hybrid and subsequently forms double-stranded DNA. The DNA copy of the viral genome is known as *provirus*. The provirus is then integrated into the host cell DNA to become a cellular gene for the rest of the life of the cell. This is in contrast to the classical transcription of the genetic information from DNA to RNA and then to proteins.

Baltimore and Tenin were the first to demonstrate that the retroviruses encode an RNA-dependent DNA polymerase and replicate through a DNA intermediate.

## Retroviruses

### Classification

All oncogenic RNA viruses are classified in the family Retroviridae; but all retroviruses are not oncogenic. The family Retroviridae, depending on (a) the diseases they cause, (b) tissue tropism and host range, (c) morphology of virions, and (d) genetic complexity are classified into three subfamilies, as follows:

**Oncovirinae:** The Oncovirinae or oncoviruses include only the retroviruses that can transform target cells. The viruses depending on their core and capsid, as demonstrated in electron microscopy, are classified further into types A, B, C, or D. These include human T-lymphotropic viruses (HTLV-1, HTLV-2, HTLV-3, and HTLV-4).

**Lentivirinae:** The lentivirinae or lentiviruses are slow (*lent*: slow) viruses associated with neurological and immunosuppressive diseases in humans as well as in animals. These include human immunodeficiency viruses (HIV-1, HIV-2), Visna virus of sheep, and caprine arthritis/encephalitis virus of goat.

**Spumavirinae:** These consist of spumaviruses, which contain nononcogenic “foamy viruses” (*spuma*: foam). These viruses are associated with asymptomatic infection in animals but are not associated with any human disease. Retroviruses belonging to

TABLE 67-1

### Retroviruses causing infections in humans

Virus	Disease
HTLV-1, HTLV-2	Adult T-cell leukemia/lymphoma
HIV-1, HIV-2	Acquired immunodeficiency syndrome
HTLV, human T-lymphotropic virus; HIV, human immunodeficiency virus.	

these subfamilies associated with human diseases are summarized in Table 67-1.

The idea that cancer could be caused by a virus was first hypothesized by Peyton Rous (1911), when he transmitted solid tumors (sarcomas) of chicken by transplanting tissue. The belief that retroviruses could be associated with human leukemia was not in favor till discovery of bovine leukemia virus (BLV) and gibbon ape leukemia virus (GALV) in 1970s. This discovery led to increased interest in a potential human lymphotropic virus.

In 1960s, Tenin was the first to predict that retroviruses could replicate their RNA genome, by transcribing it into DNA by the enzyme reverse transcriptase. This observation was supported by results of a study reported separately by David Baltimore. The discovery of reverse transcriptase was revolutionary, because it contradicted the central dogma of molecular biology that genetic information is passed in one direction from DNA to RNA and then to protein. Baltimore and Tenin were awarded the Nobel Prize for their revolutionary work, which subsequently contributed immensely to the progress and developments in molecular biology.

Minna and Gazdar were the first to detect the first human leukemic retrovirus in 1979; but it was Poiesz and Gallo in 1980 who conclusively demonstrated the infectivity, antibody response, and evidence of provirus from the first human T-cell lymphotropic virus, or HTLV-1, isolated from a patient with a cutaneous T-cell malignancy. Subsequently, many human cancers caused by HTLV-1 were reported from different parts of the world.

## Properties of the Virus

### ► Morphology

The retroviruses are enveloped, mostly spherical viruses that measure 80–120 nm in size. The envelope of the virus is acquired by budding from the plasma membrane and contains viral glycoprotein. The virus consists of two identical copies of



TABLE 67-2

Retrovirus genes and their functions

Virus	Gene	Function
Retroviruses	<i>gag</i>	Group-specific antigen: core and capsid protein
Retroviruses	<i>pol</i>	Polymerase: reverse transcriptase, protease, integrase
Retroviruses	<i>env</i>	Envelope: glycoprotein
HTLV	<i>tax</i>	Transactivation of viral and cellular genes
HIV-1	<i>tat</i>	Transactivation of viral and cellular genes
HTLV	<i>rex</i>	Regulation of RNA splicing and promotion of export to cytoplasm
HIV-1	<i>rev</i>	Regulation of RNA splicing and promotion of export to cytoplasm
HIV-1	<i>nef</i>	Alteration of cell activation signals and progression to AIDS
HIV-1	<i>vif</i>	Viral infectivity and promotion of assembly
HIV-1	<i>vpu</i>	Facilitation of release of virus and decrease of cell surface CD4
HIV-1	<i>vpr (vpx)</i>	Transport of complementary DNA to nucleus and arrest of cell growth
Retroviruses	LTR	Promoter, enhancer elements

HTLV, human T-lymphotropic virus; HIV, human immunodeficiency virus; AIDS, acquired immunodeficiency syndrome; LTR, long terminal repeat (sequence).

linear, single, positive-stranded RNA genome. The virus also contains the cellular transfer RNAs (tRNAs) and the enzymes reverse transcriptase and integrase. The tRNAs are used as primers for the enzyme reverse transcriptase.

The presence of the enzyme reverse transcriptase—an unusual enzyme, which is RNA-dependent DNA polymerase—is the characteristic feature of retroviruses. The enzyme prepares a copy from RNA to DNA, unlike the classical transcription of genetic information from DNA to RNA.

Reverse transcriptase prepares a DNA copy of the retroviral RNA genome, which is initially an RNA–DNA hybrid but later forms a double-stranded DNA provirus. Infection with oncogenic retroviruses leads to integration of the provirus randomly with the host chromosome, and it becomes a cellular gene for the rest of the life of the cell. All the proteins of retroviruses are translated from provirus.

The genome of the simple retroviruses consists of three major genes that encode glycoproteins of the virus. These are *gag*, *pol*, and *env* genes. The *gag* gene encodes for group-specific antigens, capsid proteins; *pol* gene for enzymes polymerase, protease, and integrase; and *env* gene for envelope glycoproteins. Proteolytic cleavage of the polyprotein encoded by the *env* gene leads to production of the viral glycoproteins. For example, the gp160 of HIV is cleaved into gp41 and gp120, and the glycoprotein gp62 of HTLV-1 is cleaved into gp46 and gp21.

Long terminal protein repeat sequences are present at the end of the genome. The long terminal repeat (LTR) sequence contains promoters, enhancers, and other gene sequences essential for binding different cellular transcription factors. Transcription of the genome is regulated by the interaction of the host transcription factors with promoter and enhancer elements in the LTR of the genome.

The complex retroviruses, HTLV and the lentiviruses including HIV consist of several accessory genes, such as *tat*, *rev*, *nef*, *vif*, *vpu* for HIV. These genes also encode several regulatory proteins that require more complex transcriptional processing than the simple retroviruses. Various retrovirus genes and their functions are summarized in Table 67-2.

### ▶ Antigenic properties

Two types of antigens are present in retroviruses. These are group-specific nucleoprotein antigen in the virion core and type-specific glycoprotein antigen in the envelope.

### ▶ Other properties

Retroviruses are heat labile, readily destroyed on exposure to heat at 56°C for 30 minutes. The viruses are also readily inactivated on treatment with mild acids, ether, and formalin. They are stable on storage at 30°C.

## Pathogenesis and Immunity

Provirus and oncogenes are two key components that play very important role in the pathogenesis of tumors induced by viruses.

- In **provirus model**, the gene enters the cell at the time of infection by tumor virus.
- In **oncogene model**, the genes for malignancy are already present in all cells of the body by virtue of being present in the sperm and egg.

The oncogenic viruses have the ability to transform the cells in cultures and induce tumors in animals. The retroviruses may induce tumors by either of the two mechanisms: (a) by inducing or altering the expression of a preexisting cellular gene or (b) by introducing a new transforming gene (*oncogene*) into the cellular genome.

### ▶ Oncogenes

Oncogenes may be of two types: viral oncogenes and cellular oncogenes.

**Viral oncogenes:** Viral oncogenes are the genes that encode proteins that induce transformation of normal cells into malignant cells. The viral oncogenes are usually of host cell origin. These oncogenes encode proteins that promote cell growth. The proteins encoded by oncogenes perform several functions. For example, the *ras* oncogene encodes a G protein that acts on the cell membrane, whereas *myc* oncogene encodes a transcription factor that acts on nucleus by binding to DNA. Viral oncogenes initiate inappropriate cell growth and malignant transformation, but are not required for the replication of viruses. Viral oncogenes of DNA and RNA viruses are summarized in Table 67-3.

TABLE 67-3

Viral oncogenes of DNA and RNA viruses

Characteristic	DNA virus	RNA virus
Prototype virus	SV40 virus	Rous sarcoma virus
Name of gene	Early-region A gene	<i>src</i> gene
Name of protein	T antigen	Src protein
Location of protein	Primarily nuclear, but some in plasma membrane	Plasma membrane
Function of protein	Protein kinase, ATPase activity, binding to DNA, and stimulation of DNA synthesis	Protein kinase that phosphorylates tyrosine
Required for viral replication	Yes	No
Required for cell transformation	Yes	Yes

**Cellular oncogenes:** Genes resembling viral oncogenes may be of two types: *cellular oncogenes* and *proto-oncogenes*. The oncogenes isolated from cancer cells are known as cellular oncogenes (*c-onc*), while similar genes found in normal cells are called proto-oncogenes.

### Key Points

- More than 20 cellular oncogenes have been identified till date. Many cells contain several different cellular oncogenes. Moreover, the same cellular oncogenes are found in a wide variety of diverse species, such as fruit flies, rodents, and humans. Some cellular oncogenes are expressed during normal embryonic development.
- The proto-oncogenes are found widely in vertebrates. These genes encode proteins essential for cell growth regulation and differentiation.

It is postulated that the cellular oncogenes may serve as precursor of viral oncogenes. Both cellular oncogenes and viral oncogenes are similar, but not identical. They differ from each other by their base sequences. Moreover, cellular oncogenes consist of introns characteristic of eukaryotic genes, but viral oncogenes do not contain any of these eukaryotic genes.

**Transfection** is the method of study of oncogenes, which can be demonstrated in mouse fibroblast cell lines, such as NIH 3T3. Foreign DNA is taken up by these cells, incorporated into their genome, and is transfected into the host cells, resulting in the formation of transforming genes. These genes have been shown to be identical with that of cellular oncogenes.

### ► Pathogenesis of retrovirus infections

Retroviruses (such as HTLV or HIV) carry a fourth gene, namely, *tax* or *tat*, next to the *env* gene. The *tax* or *tat* is a transactivating gene that regulates the function of the viral genes. The oncogenic retroviruses may be slow transforming viruses or acute transforming viruses.

The slow transforming viruses, such as chronic leukemia viruses, have a low oncogenic potency and induce malignant changes, usually only of blood cells, and that after a long latent period. They replicate normally and do not transform cultured cells.

The acute transforming viruses, in contrast, are highly oncogenic. They induce malignancy in infected cells after a

short latent period of weeks or months. They transform cells in culture and can cause different types of malignancies, such as sarcoma, carcinoma, and leukemia. Unlike slow transforming viruses, the acute transforming viruses are unable to replicate normally because they carry an additional gene, the viral oncogene (*v-onc gene*) on their genome, which replaces some of the genes necessary for replication of viruses. The *v-onc gene* can replicate only if coinfecting with a standard helper retrovirus. Therefore, most of these acute transforming viruses are replication defective viruses.

Rous sarcoma virus, however, is an exception, which is replication competent. It carries the oncogene *src*, which can replicate normally, because it consists of all the genomes *gag*, *pol*, and *env*, which are essential for normal replication.

Recombination between retroviral and cellular genes, gene amplification and mutations, chromosomal translocation, and promoter insertion are few of the genetic processes that appear to play important role in conversion of benign proto-oncogenes to cancer genes.

## Clinical Syndromes

### ► Humans

HTLVs, which are described later, are the viruses that have been associated with T-cell lymphoma and leukemia.

### ► Animals

**Sarcoma and acute leukemia viruses:** The sarcoma and acute leukemia viruses cause infection primarily in animals. They are not associated with any human infections. The avian leukosis complex virus includes a group of antigenically related viruses, which induce avian leukosis or sarcoma in fowls.

**Leukemia viruses:** These are slow oncogenic viruses, which induce malignancies after a long latency period of even 30 years. These viruses promote cancerous growth by indirect ways as compared to the oncogene-encoded acute leukemia or sarcoma viruses. These viruses specifically have a *tax* gene, which is a transcriptional regulator and is capable of activating LTR sequences that enhance expression of cellular growth genes. This leads to uncontrolled cell growth, which may transform the cells neoplastically or promote other genetic changes over a long period of time.

**Other viruses:** Murine leukemia viruses, which consist of several strains of murine leukemia and sarcoma viruses, are associated with infections in mice. Mammary tumor virus of mice is associated with mammary cancer only in certain susceptible strains of mice having a high natural incidence of breast cancer. Leukosis sarcoma viruses of other animals consist of a large number of viruses that have been associated with leukosis and sarcoma in cat, hamster, rat, guinea pig, and monkey.

## Epidemiology

Retroviruses are documented from different host species worldwide. Retroviruses show host specificity, the specificity being determined mainly by the presence of viral receptors on the host cell surfaces. Retroviruses can be transmitted in two ways: exogenous and endogenous.

- Most oncogenic retroviruses are exogenous. They are transmitted horizontally.
- Endogenous retroviruses are transmitted vertically from parents to offspring, and the process is mediated by the provirus integrated with germ line cell genome. This provirus behaves like a cellular gene and is under regulatory control of the host cell.

## Laboratory Diagnosis

Most of the endogenous retroviral infection can be detected by molecular techniques, such as nucleic acid hybridization or by activation after exposure to radiation or chemicals.

## Treatment

No specific treatment is available for the management of retroviral infections.

## Human T-Lymphotropic Viruses

HTLV-1 is one of the six distinct retroviruses known to infect human lymphocytes, others being HTLV-2, HTLV-3, HTLV-4, HIV-1, and HIV-2. HTLV and HIV are two important members of the retrovirus family. Both the viruses are the enveloped viruses. Both have enzyme reverse transcriptase in the virion and two copies of a single-stranded, positive-polarity RNA genome. The HIV virus is described in Chapter 68.

## Properties of the Virus

### ► Morphology

HTLV-1 shows following features:

- It is an enveloped, spherical virus measuring 100 nm in diameter.
- The virus consists of a single-stranded RNA with diploid genome, which has the property to replicate through DNA intermediary and is able to integrate into host T cell genome as a *provirus*.

- The genome contains LTRs, which encode for a large number of polyproteins processed by virally encoded protease and cellular protease into functional peptides. The gene *px* encodes for Tax and Rex proteins, which regulate gene expression in the virus. The *gag* gene encodes structural proteins of matrix, capsid, and nucleocapsid; *pol* gene encodes several enzymes, such as protease, polymerase, and integrase; *env* gene encodes gp46 and gp21 (a 221-kDa transmembrane glycoprotein).
- HTLV is morphologically similar to HIV except that it has a centrally located nucleocapsid core in a mature virion. HTLV also differs from HIV by having a unique genome. The genome has the same *gag-pol-env* motif with LTR sequences as those of HIV, but it differs from HIV by having a fourth sequence (*xp*), which participates in transcription.

### ► Viral replication

The HTLV has two important genes *tax* and *rex*, which regulate viral replication. The main function of *tax* gene is transactivation of viral and cellular genes, and that of *rex* gene is regulation of RNA splicing and promotion of export to cytoplasm.

**Tax gene:** It is a transcriptional activator, which enhances transcription of the viral genome from the promoter gene sequences in the LTR. It also activates other genes including those for interleukin (IL)-2, IL-3, GM-CSF (granulocyte macrophage colony-stimulating factor), and the receptor for IL-2. Activation of this gene promotes the growth of infected T cells.

**Rex gene:** It encodes two proteins that bind to structure on the viral mRNA and thereby prevent splicing and promote mRNA transport to the cytoplasm. Later during the course of infection, the *rex* gene selectively enhances expression of the singly sliced structural genes, which are required in large quantities.

HTLV primarily infects CD4+ cells. The virus enters the cell and within the cytoplasm, reverse transcriptase of the virion synthesizes a DNA copy of the genome. The genome is then transported into the nucleus and is integrated with the cell DNA by the virally encoded integrase, resulting in an infection. The host cell RNA polymerase makes viral RNA, and transcription is upregulated by Tax protein. The latter facilitates transcription of viral genome and Rex protein modulates processing of viral pre-mRNA.

The Rex protein controls the synthesis of the *gag/pol* mRNA, the *env* mRNA, and their subsequent transport to the cytoplasm, where they are translated into structural viral proteins. Virion genome RNA is also synthesized and transported to the cytoplasm. The virus-encoded protease mediates conversion of precursor polypeptides into functional structural proteins. The nucleocapsid of the virion is assembled in the cytoplasm and budding takes place at the outer cell membrane.

### ► Antigenic and genomic properties

Six different HTLV-1 subclasses exist. Each subtype is endemic in a particular geographical area. The oncoviruses include HTLV-1, HTLV-2, and HTLV-3, but only HTLV-1 has been associated with human disease. HTLV-1 and HTLV-2 share as much as 50% homology. Two new HTLVs, HTLV-3 and

HTLV-4, have recently been described in a small number of Africans, with no particular illness.

## Pathogenesis and Immunity

HTLV-1 is a lymphotropic virus. The HTLVs are distinguished from HIV as they cause lymphoproliferative disorder, whereas HIV causes lymphocytosis. It enters the host by sexual intercourse, breast feeding, or blood transfusion.

### ▶ Pathogenesis of HTLV infection

After entry in humans, the virus spreads through circulation and infects the CD4 helper and DTH (delayed-type hypersensitivity) T cells. These T cells are most commonly present in the skin as well as in the neurons. Recent evidences show that glucose transporter (GLUT-1) is a supportive receptor for HTLV-1 cell entry. The ubiquitous distribution of GLUT-1 may help explain the viral tropism of HTLV-1.

HTLV predominantly infects and integrates lymphocytes. Once the infection is transmitted, the *tax* gene (which encodes Tax protein) transactivates the cellular genes for T-cell growth factor and IL-2 and their receptors, all of which activate growth in the infected cells. The viruses in the infected cell may remain latent or may replicate slowly for many years and may also induce the clonal outgrowth of particular T-cell clones.

There is a long latency period of approximately 30 years before the onset of leukemia. Although the exact mechanism of viral pathogenesis of T-cell leukemia that occurs in 3–5% of individuals is not known, *in vitro* studies have shown that the *tax* gene plays an important role.

### Key Points

- *Tax* gene contributes in a number of ways to activities of the cellular genes that either causes cell promotion or inhibits nucleic acid repair mechanism.
- The gene also inhibits normal apoptosis of lymphocytes and therefore facilitates their growth.
- It has also been shown that lymphocytic cells tend to accumulate damaged DNA and proliferate when *tax* gene is active.
- Tax protein plays a very important role in growth of virus and pathogenesis of the disease. It contributes for extensive cell proliferation.

It has also been demonstrated that HTLV can spread by cell-to-cell contact without replication, but it is not clear how HTLV crosses the blood–brain barrier to cause neurological sequelae of HTLV infection.

## Host immunity

The immune response to HTLV infection in humans is characteristic and depends on whether the patient develops malignancies or neuropathy. HTLV infection is characterized by the development of circulating antibodies within 4–8 weeks, which remain positive for the rest of the life. Paradoxically, the patients who have got high level of antibodies appear to be at a greater risk for HTLV-1-associated myelopathy/tropical spastic

paraparesis (HAM/TSP). These antibodies do not confer any protective immunity in patients.

Cell-mediated immunity (CMI) fails to eradicate HTLV infection possibly due to ability of the virus to spread without replication, through cell-to-cell contact. The CMI through its cytotoxic T-cell lymphocytes appears to contribute to the intramedullary degeneration of the central nervous system. On the other hand, cytotoxic T-cell lymphocyte responses in patients with HTLV are depressed, which leads to increase in the number of transformed cells.

## Clinical Syndromes

HTLV-1 is the causative agent of (a) adult T-cell leukemia (ATL), (b) HTLV-1-associated myelopathy/tropical spastic paraparesis, (c) HTLV-associated uveitis, and (d) HTLV-1-associated infective dermatitis.

### ▶ Adult T-cell leukemia

Adult T-cell leukemia (ATL) is seen in approximately 1 in 20 persons infected by HTLV-1 over a period of 30–50 years. The condition is a malignancy of the CD4 helper T cells, which can be acute or chronic. Acute ATL comprises 55–75% of all the ATL cases. Lymphadenopathy (both in the periphery and within the body cavities) represents the classic form of ATL. Hepatosplenomegaly, hypercalcemia, and lytic bone lesions are the other manifestations. Death is caused due to opportunistic infections, pulmonary complications, and sepsis. Chronic ATL is a less common manifestation.

### ▶ HTLV-1-associated myelopathy/tropical spastic paraparesis

HTLV-1-associated myelopathy/tropical spastic paraparesis (HAM/TSP) is a slowly progressing degenerative disease that primarily affects the corticospinal tract of the thoracic spinal cord. The incubation period of HAM/TSP can be as short as 3 months when infection is transmitted by blood transfusion, but is usually 3 years. Patients with HAM/TSP may present with weakness and stiffness in lower limbs, urinary incontinence, and lower back pain.

### ▶ HTLV-associated uveitis

HTLV-associated uveitis is a less frequent manifestation. The condition is associated with the presence of HTLV-infected lymphocytes in vitreous fluid of the eye.

### ▶ HTLV-associated infectious dermatitis

HTLV-associated infectious dermatitis is a chronic and severe form of dermatitis seen during childhood. HTLV-2 has not been associated with any lymphoproliferative disease in humans. It is doubtful that HTLV types 3 and 4 cause any human disease.

## Epidemiology

HTLV-1 infection is endemic in Japan, South America, Northern Oceania, and Tropical Africa and in the Caribbean

ocean. Few foci of infection have also been documented in Asia in Philippines. HTLV-1 is transmitted from mother to child through breast milk during the act of breast feeding or during child birth. In adults, transmission is primarily through sexual contact. Apparently, a prolonged period of sexual contact is necessary for transmission of the disease. Homosexual contact, however, appears to play less important role in transmission of the disease. Blood transfusion and intravenous drug abuse are also other very important modes of transmission of HTLV-1.

## Laboratory Diagnosis

Biopsy is useful for definitive diagnosis and classification of HTLV. The presence of convoluted nuclei, also known as *cloverleaf* or *flower lymphocytes* in the peripheral blood is typical of ATL. Provirus can also be demonstrated in these malignant cells. Western blot, immunofluorescence antibody test, and HTLV-ELISA are serological tests used in diagnosis of HTLV-1 infection. HTLV-ELISA is a frequently used test to demonstrate antibodies in the serum for diagnosis of HTLV-1 infection. The test is widely used to study seroprevalence of HTLV-1 infection in the community in the highly endemic regions of Japan, the United States of America, and Africa. High false positivity is a noted problem with ELISA, particularly in areas of low prevalence. Hence, all HTLV-ELISA-positive cases need to be confirmed with Western blot, immunofluorescence antibody test, or polymerase chain reaction (PCR).



### Molecular Diagnosis

PCR is useful to distinguish between HTLV-1 and HTLV-2 infections. It is also useful in infants who are suspected of having false-positive results due to the presence of circulating maternal anti-HTLV antibodies.

## Treatment

No specific treatment is available for the management of HTLV-1 infection. But a limited success has been obtained in chemotherapy of some patients with combination of AZT and interferon-alpha. However, no known regimen increases the survival time of the patients beyond 2 years. Relapse is common.



### CASE STUDY

A 35-year-old man, resident of an area endemic for HTLV infection, in Japan was admitted with presentation of weakness and stiffness in lower limbs, urinary incontinence, and lower back pain for a period of 3 months. The person gave a history of receiving blood transfusion nearly 2 years back. Serum was positive by HTLV-ELISA. The person was suspected to be suffering from HTLV-1-associated myelopathy.

- What are the other tests you will perform to confirm the diagnosis?
- What are the other clinical syndromes associated with HTLV-1 infection in humans?
- What are the countries in which HTLV-1 infection is endemic?
- Describe the pathogenesis of HTLV-1 infection in humans.

## Prevention and Control

Preventive measures include health education, which should focus on:

- (a) avoidance of breast feeding by known infective mothers,
- (b) use of safe sexual practices by couples, and
- (c) screening of blood donors for HTLV antibodies.

Properties of various retroviruses are summarized in Table 67-4.

## Endogenous Retroviruses

Endogenous retroviruses are those retroviruses that are integrated into and become part of chromosomes in humans and animals. These proviruses are similar to those of HTLV, mouse mammary tumor virus, and other retroviruses that have been detected in humans. These viruses usually lack the ability to replicate because they are poorly transcribed or because of deletion of the insertion of termination codons.

## Other Oncogenic Viruses

Oncogenic DNA viruses are examples of other viruses associated with malignancies in humans and animals. The list of such viruses is summarized in Table 67-4.

TABLE 67-4

Properties of retroviruses

Examples	Characteristics
Mouse mammary tumor virus	Have eccentric nucleocapsid core in mature virion
Human T-lymphotropic virus (HTLV-1, HTLV-2, HTLV-5), Rous sarcoma virus (chickens)	Have centrally located nucleocapsid core in mature virion
Human immunodeficiency virus (HIV-1, HIV-2), Visna virus (sheep), Caprine arthritis/encephalitis virus (goats)	Slow onset of diseases; cause neurological disorders and immunosuppression; have D-type, cylindrical nucleocapsid core
Human foamy virus	Shows vacuolated foamy cytopathology; no clinical disease
Human placental virus	Have retrovirus sequences that are integrated into human genome

# Human Immunodeficiency Virus

## Introduction

Human immunodeficiency virus (HIV) is a retrovirus that causes acquired immunodeficiency syndrome (AIDS). AIDS is one of the most devastating epidemics ever recorded in the world. AIDS was first recognized in Los Angeles in 1981, when five cases of *Pneumocystis carinii* (now called *Pneumocystis jirovecii*) pneumonia in homosexual men and drug addicts were reported. The causative agent of AIDS was first reported by Luc Montagnier and colleagues from the Pasteur Institute, Paris, in 1983. They isolated a retrovirus from a West Asian patient with persistent generalized lymphadenopathy and named it *Lymphadenopathy-associated virus* (LAV). In 1984, Robert Gallo and colleagues from the National Institute of Health, USA, reported isolation of a retrovirus from patient with AIDS and called it *human T cell lymphotropic virus-III* (HTLV-III).

The International Committee on Virus Nomenclature in 1986 gave the name *human immunodeficiency virus*, or HIV, for the same virus. HIV-1 is first isolated virus from the cases of AIDS, and HIV-2 has been isolated from some case of AIDS from West Africa.

## HIV Virus

### Classification

HIV is a *Lentivirus*, a sub family of *Lentiviridae* in the family retrovirus. This family includes the viruses known for (i) poor host immune responses, (ii) latency, (iii) persistent viremia, and (iv) infection of the central nervous system. HIV, like other retroviruses, are enveloped RNA viruses, characteristically possessing an RNA-dependent DNA polymerase called reverse transcriptase.

### Properties of the Virus

#### ► Morphology

HIV is a spherical, enveloped virus, which measures up to 120 nm in diameter (Fig. 68-1). It has a unique three-layered structure: (i) the innermost genome layer, (ii) middle cone-shaped nucleocapsid, and (iii) an outer membrane of glycoprotein surrounded by lipoprotein envelope.

**Viral genome:** HIV genome is most complex of human retroviruses. The genome is diploid and consists of two identical copies of single-stranded positive-sense RNA genome. The HIV

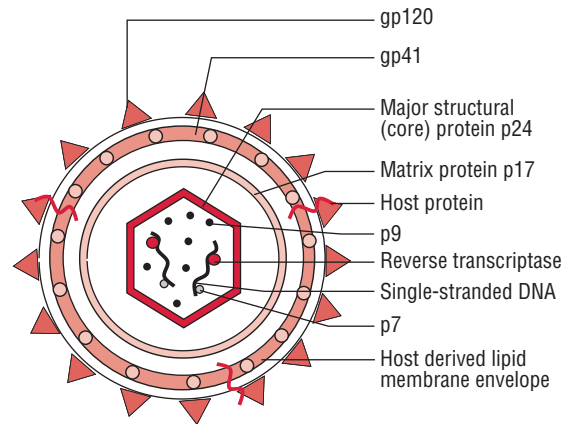

FIG. 68-1. Schematic diagram of HIV.

genome is most complex of human retroviruses. It contains three major genes *gag*, *pol*, and *env*, characteristic of all retroviruses. All these genes encode for the structural proteins.

The *gag* gene encodes for internal capsid and matrix “core” proteins (p15, p18, and p24). Of these three proteins, p24 is the major antigen, which is demonstrated in serum of HIV patients during the early stage of infection and persists till the appearance of serum antibodies. Detection of p24 antigen in serum, therefore, is of diagnostic value.

The *pol* gene encodes for several proteins, including the enzymes reverse transcriptase, integrase, and protease. The enzyme reverse transcriptase synthesizes DNA by using the genome RNA as a template. The enzyme integrase integrates the viral DNA into the cellular DNA, and the enzyme protease cleaves various viral precursor proteins. The *pol* gene expresses precursor protein p160, which is cleaved into three proteins: p31, p51, and p64.

The *env* gene codes gp160, a precursor glycoprotein that is split to form two envelope glycoproteins, gp120 and gp41, which form the surface spikes and transmembrane tissue proteins, respectively.

Apart from these genes, it also consists of six other regulatory genes (*tat*, *rev*, *nef*, *vif*, and *vpr*) including an additional gene *vpu* in HIV-1 and *vpx* in HIV-2.

Regulatory genes encode several proteins, which are essential for transcription and invasion of virion into host cells. *tat* gene is the most important one, which encodes a protein called Tat protein that facilitates viral gene transcription. Tat protein along with other HIV-encoded regulatory protein called Nef suppresses the synthesis of class I MHC

TABLE 68-1

## HIV genes and their products

Gene	Gene product	Description
<i>gag</i>	p24	Nucleocapsid core protein
	p15	Nucleocapsid core protein
	p55	Precursor of core protein
<i>env</i>	p18	Polyprotein from <i>gag</i> gene
	gp120	Outer envelope glycoprotein
	gp41	Transmembrane envelope glycoprotein
<i>pol</i>	gp160	Precursor of envelope glycoproteins
	p31	Reverse transcriptase
	p51	Reverse transcriptase
	p64	Reverse transcriptase

(major histocompatibility complex) proteins, thereby reducing the ability of cytotoxic T cells to kill the HIV-infected cells. The *rev* gene encodes another regulatory protein, which controls transport of mRNA from the nucleus into the cytoplasm. The functions of the genes are summarized in Table 68-1.

**Nucleocapsid:** The viral genome is surrounded by a nucleocapsid consisting of proteins. Three enzymes: (i) reverse transcriptase, (ii) integrase, and (iii) protease are located in the nucleocapsid.

- Reverse transcriptase** performs two important functions. First, it transcribes the RNA genome into the proviral genome. Second, it also has a ribonuclease H activity, which degrades the RNA when it is in the form of an RNA-DNA hybrid molecule. Degradation of the viral RNA genome is an essential step in the synthesis of double-stranded proviral DNA.
- Integrase** is other important enzyme, which facilitates integration of proviral DNA into the host cell DNA.
- Protease** is another enzyme, which splits precursor polyproteins into functional viral polypeptides.

**Envelope:** The virus is surrounded by a lipoprotein envelope. The lipid component is derived from the host cell membrane and glycoproteins, which are virus coded. The major virus coded envelope glycoproteins are the projecting spikes on the surface and the anchoring transmembrane pedicles. The projecting spikes combine with the CD4 receptors on susceptible host cells, and transmembrane pedicles cause cell fusion.

### ► Viral replication

HIV replication is similar to that of other retroviruses. The virus binds to the CD4 proteins on the cell surface with the help of its gp120 envelope protein (Fig. 68-2). This protein also interacts with chemokine receptors on the cell surface. Then gp41 of the virus mediates fusion of the viral envelope with the cell membrane followed by entry of the virus into the cell.

CXCR4 and CCR5 are the chemokine receptors, which are very much essential for entry of HIV into CD4<sup>+</sup> cells. The T-cell-tropic strains of HIV bind to CXCR4 and the

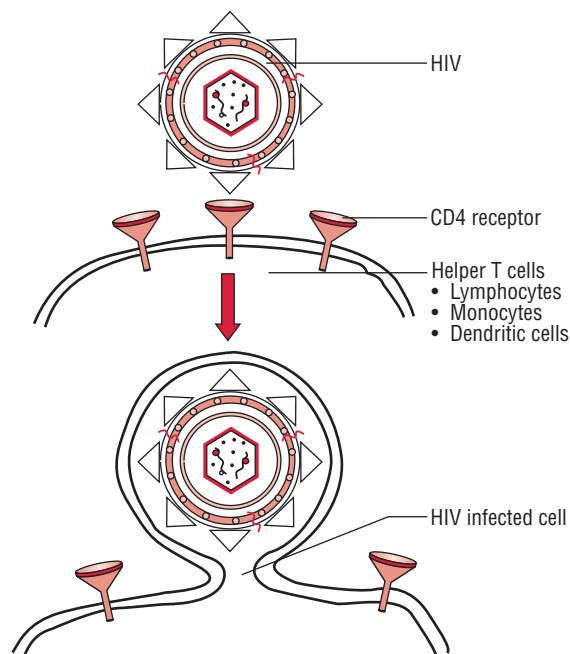

FIG. 68-2. Invasion by HIV.

macrophage-tropic strains bind to CCR5. Once inside the cell, after uncoating, the virion RNA-dependent DNA polymerase transcribes the genome RNA into double-stranded DNA, which subsequently integrates with the host cell DNA. Integration is mediated by the viral enzyme integrase. The host cell RNA polymerase transcribes the viral mRNA from the proviral DNA.

The viral mRNA encodes several proteins, which are cleaved by many enzymes. For example, the Gag protein is cleaved by the virus-encoded protease to form the main core protein (p24), the matrix protein (p17), and several smaller proteins. The Pol protein is also cleaved by protease to produce reverse transcriptase, integrase, and protease. The Env protein is cleaved by a cellular protease.

The immature virions containing the precursor polyproteins are assembled in the cytoplasm, and cleavage by the viral protease occurs as the immature virion buds from the cell membrane, resulting in the production of mature infectious HIV.

### ► Antigenic and genomic properties

HIV shows two distinct antigens: (a) group-specific antigen and (b) type-specific envelope glycoproteins.

**Group-specific antigen:** The protein p24 is the group-specific antigen present in the core of the virus. p24 is stable and does not show variations. Serum antibodies against p24 antigen are not protective and do not neutralize infectivity of HIV. But p24 is an important serological marker for diagnosis of HIV.

**Type-specific envelope glycoproteins:** gp120 and gp41 are the type-specific envelope glycoproteins, which are present on the surface of the virus. gp120, which protrudes from the surface, is the most important that combines with CD4 receptors as well as the chemokine receptors on surface of CD4 cells. It shows many antigenic variants due to mutations

in the gene that encodes the antigen. V3 loop is the most immunogenic region of the gp120 and also shows significant antigenic variations. Antibodies against gp120 neutralize the infectivity, but the rapid emergence of gp120 variants does not confer protection against new strains; hence it is difficult to produce an effective vaccine. gp41, which is embedded in the envelope, mediates the fusion of the viral envelope with the cell membrane at the time of infection.

HIV shows two distinct antigenic types: HIV-1 and HIV-2. The envelope antigens of both the types are different. Their core polypeptide shows some degree of cross-reactivity. HIV-2 is more closely related to simian immunodeficiency virus than to HIV-1.

HIV-1 represents the original isolates from Americas, Europe, and other Western countries, whereas HIV-2 isolates are originated from Western Africa. HIV-2 is more closely related to simian immunodeficiency virus than to HIV-1.

HIV-1 and HIV-2 strains based on sequence analysis of either *gag* or *env* genes have been classified into three groups: M (major/main), N (non-M, non-O/new), and O (other). The M group is the most prevalent group, which causes majority of HIV-1 infections. Group M consists of nine subtypes: A-D, F-H, J, and K; all of which have originated from Central Africa and are prevalent all over the world. Groups N and O include only some HIV-1 isolates from Central Africa, which do not belong to the group M.

### ► Other properties

HIV is a thermolabile virus. It is readily inactivated at 60°C in 10 minutes and at 100°C in seconds. The virus in dried blood, at room temperature (20–25°C), may survive for up to 7 days. The virus has been isolated from various tissues even up to 16 days at autopsy of the patient infected with HIV.

HIV is inactivated by treatment with 50% ethanol, 35% isopropanol, 0.5% lysol, 0.5% formaldehyde, 0.3% hydrogen peroxide, and 10% bleaching powder in 10 minutes. Bleaching powder is an effective disinfectant for use as surface decontaminant at a concentration of 0.5%, with free chlorine 5 g/L (5000 ppm). A 2% solution of glutaraldehyde is effective for disinfection of medical instruments.

In liquid plasma or in lyophilized blood products, HIV can be inactivated by heating at 56°C for 30 minutes. It is also inactivated at a very low pH (1) and high pH (13).

## Virus Isolation

### ► Cell culture

HIV can be cultured by cocultivation of lymphocytes with potentially infected and uninfected mononuclear cells to promote viral replication. Primary isolates of HIV grow very slowly on cell lines compared with laboratory-adopted strains. Virus growth is detected by testing the culture supernatant fluid to demonstrate p24 antigen or viral reverse transcriptase activity after incubation of the culture for an average period of 7–14 days or even larger (28 days).

## Pathogenesis and Immunity

HIV is primarily a sexually transmitted pathogen transmitted by high-risk behaviors, such as unprotected intercourse, male homosexual intercourse, and also by intravenous (IV) drug abuse. The tropism of the HIV for CD4-expressing T-cells and macrophages is the principal determinant of the pathogenicity of HIV. HIV shows tropism for all the cells expressing CD4 antigens on their cell surfaces. The CD4 antigens act as receptors for HIV. The virus infects helper T cells and kills them, resulting in HIV-induced immunosuppression, leading to full-blown AIDS—a key feature of the pathogenesis of HIV infection. This makes the patient most susceptible to opportunistic infections and certain cancerous conditions, such as Kaposi's sarcoma and lymphoma. However, the virus does not directly cause any tumor, because HIV genes are not found in these tumor cells.

### ► Pathogenesis of HIV infection

In the genital tract, infection with HIV begins in Langerhans cells, the dendritic cells that line the mucosa. This is followed by infection of the local CD4+ helper T cells in the genital tract and by the appearance of the virus in the blood 4–11 days after infection. The CD4 receptors are present on CD4 T lymphocytes and also on the cells of the macrophage lineage, such as monocytes, macrophages, and alveolar macrophages of lungs, dendritic cells of the skin, and microglial cells of the brain (Fig. 68-3).

gp120 protein is the principal determinant of pathogenicity of HIV. The V<sub>y</sub> region of the gp120 determines cellular tropism of the virus. After HIV enters the host, gp120 binds selectively to the CD4 cell surface receptors and CCR5 or CXCR4 chemokine receptors expressed on macrophage lineage cells.

After gp120 binds to the receptor, the associated gp41 protein initiates the cell membrane fusion. After fusion with the host cell membrane, the virus loses its envelope and reverse transcription of RNA to DNA occurs. The reverse transcriptase ribonuclease mediates transcription of the RNA into double-stranded DNA provirus. The provirus is integrated into the genome of the infected cell causing latent infection. The long and variable incubation period of HIV is because of this latency. During the period of latency, there is a high level of viral replication. It is estimated that 10 billion HIV particles are produced and destroyed each day.

The gp120 present on the surface of the infected cell leads to fusion of the cells with the formation of multinucleated syncytia. The lysis of fused cells results in replenishment of a large number of uninfected cells from the circulation. HIV also causes accumulation of nonintegrated circular DNA copies of the genome, increased permeability of the plasma membrane, and induction of apoptosis. All these contribute to killing of the infected T cells. In addition, lysis of infected cell releases progeny virions to infect new cells. The CD4 cells are decreased in number, and the CD4:CD8 cell ratio is reversed. Viral infection also suppresses the function of the infected cell without causing structural damage.

The virus replicates continuously in the lymph nodes, thereby releasing the virions and infected T cells into the blood.



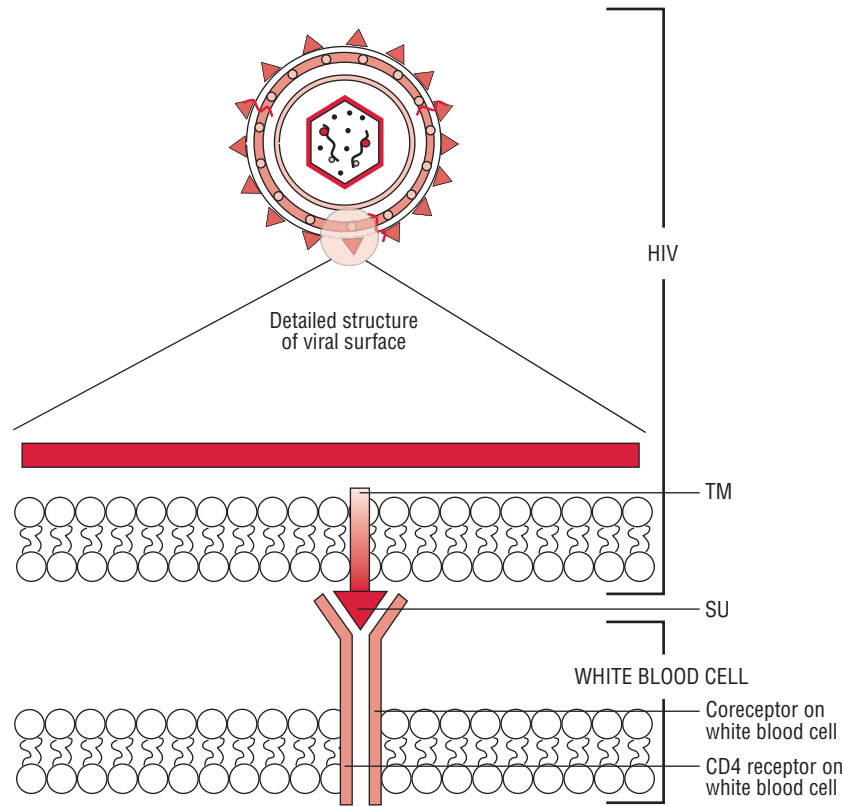

FIG. 68-3. Pathogenesis of HIV infection.

During the course of infection, the virus causes a drastic reduction in the number of CD4 T cells, which may occur due to HIV-induced cytolysis, cytotoxic T-cell immune cytolysis, or natural terminal differentiation of T cells.

The virus also infects brain monocytes producing multinucleated giant cells and significant central nervous system manifestations. The fusion of the HIV-infected cells in the brain and other sites is the key pathological finding.

### Host immunity

HIV is characterized by development of both cell-mediated and humoral immunities against HIV-related proteins.

**Cell-mediated immunity:** Cellular immunity is characterized by the development of cellular responses produced against HIV proteins. Suppression of cell-mediated T-cell immunity is the most profound consequence of HIV infection. CD4 helper T cell, monocytes, and macrophages are important components of CMI against HIV infection. The CD4 helper T cell plays a very important role in the outcome of immune responses. The CD4 helper cells are essential for (a) activation of macrophages and (b) induction of functions of cytotoxic T cells, natural killer cells and B cells, and a variety of soluble factors that stimulate growth and differentiation of lymphoid cells. HIV binds directly to the CD4 receptors of the T helper cells, resulting in gradual depletion of the T-cell population.

The deficiency or reduction of CD4 T cells leads to depression of cellular immune response and impairment of humoral

responses. The reduction of CD4 T cells is responsible for producing delayed-type hypersensitivity reaction that leads to opportunistic infections caused by many opportunistic pathogens. This causes CMI to gradually fail (i) to mount cytotoxic T-cell response to virally infected cells, (ii) to form delayed-type hypersensitivity reaction, and (iii) to process new foreign substances presented to the immune system.

Monocytes and macrophages also play an important role in the dissemination and pathogenesis of HIV infection. CCR5 chemokine receptors are the major HIV coreceptors present on monocytes and macrophages, which appear to be the major cell types infected with HIV in the brain. These cells, therefore, contribute immensely for development of neurological manifestations associated with HIV infection. In the lungs, infected pulmonary alveolar macrophages may also play a role in the development of interstitial pneumonitis observed in some HIV patients.

The macrophage-tropic strains of HIV are seen in large number early in the infection, and these strains are responsible even for transmission of the infection. The virus may enter brain through infected monocytes and release toxins to neurons as well as chemotactic factors that lead to infiltration of brain with inflammatory cells. The macrophage-tropic HIV viruses are usually not present, but may be present rarely in neurons, oligodendrocytes, and astrocytes.

**Humoral immunity:** Humoral immunity is characterized by the development of neutralizing antibodies produced against p24, gp120, gp41, and various proteins in most of the

TABLE 68-2

**Mechanisms of HIV escape from the immune system of the host**

Mechanism	Method
Inactivation of key element of immune defense	Infection of lymphocytes and macrophages
Loss of activator of the immune system and delayed type hypersensitivity	Inactivation of CD4 helper cells
Evasion of antibody detection	Antigenic drift of gp120
Evasion of antibody detection	Heavy glycosylation of gp120

individuals infected with HIV. However, the level of neutralizing activities is low. In adults, antibody to gp120 develops several months after the initial viremia. The development of neutralizing antibodies is associated with slow progression of disease in adults, children, and infants. The HIV escapes from the immune system of the host in many ways (Table 68-2).

**Key Points**

HIV escapes from the immune system through its ability:

- to integrate viral DNA with the host cell DNA, resulting in persistent infection,
- to undergo high rate of mutation of the *env* gene,
- to produce Tat and Nef proteins that downregulate class I MHC proteins required for cytotoxic T cells to recognize and kill HIV-infected cells, and
- to infect and kill CD4<sup>+</sup> helper T cells. Continuous virus reproduction in macrophages and CD4 T cells also maintains the virus in an immune privileged state.

**Clinical Syndromes**

The course of untreated HIV infection is usually 10 years or longer. The disease progresses through the stages of (a) primary infection, (b) dissemination of virus to lymphoid organs, (c) clinical latency, and (d) a late stage of profound immunosuppression known as full-blown AIDS. HIV is associated with following clinical syndromes:

**▶ Acute HIV infection**

Acute HIV infection is characterized by rapid rise in plasma viremia with a concomitant drop in CD4 count after an incubation period of 3–6 weeks. The symptoms of HIV are nonspecific and include low-grade fever, fatigue, malaise, rash, headache, and lymphadenopathy; spontaneous resolution may occur within weeks. HIV antibodies are usually absent in the serum at the onset of illness, but begin to appear after 3–4 weeks of the infection. This condition is referred to as seroconversion illness. Serum antibodies are not demonstrated, but p24 antigen can be demonstrated during the beginning of the infection.

**▶ Asymptomatic HIV infection**

This period is followed by an asymptomatic or clinically latent stage during which the patient continues to remain asymptomatic for several months to years. This stage is characterized by a

low level of viral replication and a gradual fall in CD4 count. The serum is positive for HIV antibodies in these patients. Another characteristic of the stage of latency is persistent generalized lymphadenopathy, which may last for several years or a period of asymptomatic infection. During this stage, virus continues to replicate in the lymph node. The persistent generalized lymphadenopathy denotes the presence of enlarged lymph nodes in two or more noncontiguous extrainguinal sites that persist for at least 3 months in the absence of any current illness or medication that may cause lymphadenopathy. This is a benign condition but may progress to AIDS-related complex (ARC) or AIDS.

**▶ AIDS-related complex**

AIDS-related complex is characterized by lymphadenopathy and fever. This has an insidious onset and may be associated with malaise and weight loss. Diarrhea, night sweats, fatigue, and opportunistic infections are the presenting symptoms. The patients with ARC may progress to AIDS in a few months.

**▶ AIDS**

AIDS is the end-stage disease of the HIV infection. It denotes the irreversible breakdown of immune system of the host, making the infected host highly susceptible to a wide range of progressive opportunistic infections or unusual malignancies, such as Kaposi's sarcoma. AIDS is characterized by deterioration of immune response as evidenced by CD4 T cell decrease response. The onset of clinical manifestations correlates with:

- a reduction in number of CD4 T cells to less than 450/ $\mu$ L,
- increased level of virus in the blood, and
- presence of p24 antigen in the blood.

When CD4 count falls less than 200/ $\mu$ L, the patient develops full-blown AIDS. This stage is characterized by development of HIV wasting syndrome with weight loss and diarrhea for 1 month. This is also associated with many opportunistic infections, such as tuberculosis, *Pneumocystis carinii* pneumonia, toxoplasmosis, cryptococcal meningitis, and other diseases. Patients with AIDS show clinical manifestations in different ways. They can manifest as lymphadenopathy with fever, opportunistic infections, malignancies, and neurological manifestations of HIV, such as dementia.

**Opportunistic infections:** The opportunistic infections are the severe infections induced by the agents that rarely cause serious disease in immunocompetent individuals. These opportunistic infections are the predominant causes of morbidity and mortality among the patients with late-stage HIV infection and full-blown AIDS. These are usually associated with HIV-infected patients when their CD4 cell count falls to less than 200 cells/ $\mu$ L. The most common opportunistic infections caused by various pathogens, such as protozoa, bacteria, viruses, and fungi are summarized in Table 68-3.

In patients with AIDS, coinfection with DNA virus often leads to enhanced expression of HIV in cells *in vitro*. Coinfection with herpes virus and cytomegalovirus (CMV) has been shown to contribute to enhance expression of HIV in cells. The CMV

TABLE 68-3

Indicator diseases of AIDS

Infection	Disease
Bacterial	<i>Mycobacterium avium-intracellulare</i> complex Extrapulmonary tuberculosis Atypical mycobacterial disease Salmonellosis Pyogenic bacterial infections <i>Campylobacter</i> infections <i>Nocardia</i> infection and actinomycosis Legionellosis
Viral	Cytomegalovirus disease Herpes simplex virus infection Hairy leukoplakia by Epstein-Barr virus Progressive multifocal leukoencephalopathy
Protozoal	Toxoplasmosis Cryptosporidiosis Isosporiasis Generalized strongyloidiasis
Fungal	<i>Pneumocystis jirovecii</i> pneumonia Candidiasis Cryptococcosis (extrapulmonary) Aspergillosis Histoplasmosis (disseminated) Coccidioidomycosis (disseminated)
Malignancies	Kaposi's sarcoma Lymphomas: Hodgkin and non-Hodgkin types
Others	HIV wasting syndrome HIV encephalopathy Lymphoid interstitial pneumonia HIV dementia

has shown to produce a protein that acts as chemokine receptor and facilitates HIV to infect the cells.

**Malignancies:** The patients with AIDS show a marked susceptibility to the development of malignancies. Human herpes virus-8-associated Kaposi's sarcoma is the most noted malignancy associated with AIDS. Kaposi's sarcoma is much more common in untreated AIDS patients than in general population. It is a vascular tumor suggested to be of endothelial origin, which is found in the skin, mucous membrane, lymph node, and visceral organs.

Other AIDS-associated malignant conditions include non-Hodgkin's lymphoma, Hodgkin's lymphoma, cervical cancer, and anogenital cancer. Burkitt's lymphoma has been shown to be even much more common in AIDS patients than in general population.

**Neurological diseases:** AIDS patients are associated with several distinct neurological syndromes. These include AIDS dementia complex, subacute encephalitis, vacuolar myelopathy, aseptic meningitis, and peripheral neuropathy. AIDS dementia complex is the most common neurological manifestation of HIV and occurs due to HIV infection of the microglial cells and neurons of the brain. This condition is characterized by poor memory, inability to concentrate, apathy, automotor retardation, and behavioral changes.

Toxoplasma encephalitis, cryptococcal meningitis, and John-Cunningham (JC) virus-induced progressive multifocal

leukoencephalopathy are some of the common infectious diseases of the brain associated with patients of AIDS. Indicator diseases of AIDS are summarized in Table 68-3.

## ▶ Pediatric AIDS

Pediatric AIDS is an important condition acquired from infected mothers. AIDS in pediatric populations usually occurs:

- by vertical transmission of HIV from infected mother or
- by perinatal transmission of HIV through breast-feeding.

Children develop clinical manifestations by 2 years of age and subsequently die of AIDS in the following 2 years. The condition is more severe in neonates because the immune system is very poor during the time of birth. Clinical manifestations of AIDS in children include pneumonia, severe oral candidiasis, interstitial pneumonitis, encephalopathy, wasting, generalized lymphadenopathy, hepatosplenomegaly, diarrhea, growth retardation, and bacterial sepsis.

The progression of vertically acquired HIV infection in children appears to have a trimodal distribution. Approximately, 15% of children have rapidly progressive disease and the remainder have a chronic progressive course or an infection pattern typical of that seen in adults.

Children with perinatally acquired HIV infection, if remain untreated, show a very bad prognosis. The progression of the infection is very fast in the first year of life and is believed to be associated with higher viral load of HIV-1 in the blood. The replication of the virus in children shows a different pattern than that seen in adults. Viral RNA load is usually low at birth, but the level of virus then increases rapidly within the first 2 months of life, followed by slow decline at the age of 2 years.

Progression of infection from acute HIV infection to AIDS occurs usually at a median 11 years after the infection. Earlier, many of the patients used to die within 1–2 years following diagnosis of AIDS, but now with the introduction of highly active antiretroviral therapy (HAART) and better management of opportunistic infections, the death rates from AIDS have begun to decline significantly. In India, mean duration of survival of a patient after diagnosis of HIV is 7 years 8 months.

## Epidemiology

HIV infection is epidemic throughout the world.

### ▶ Geographical distribution

HIV-1 is the most common cause of HIV infection in the Americas, Europe, Africa, and Asia. HIV-1 subtypes show differences in their geographical distribution. Subtype A predominates in West Africa; subtype B in the United States, Europe, and Australia; subtype C in India, China, and Southern Africa. HIV-2 is the most common cause of HIV epidemics in West Africa. This virus is also found in European countries.

Since the first recognition of AIDS in the United States in 1981, the AIDS has become a worldwide disease, affecting a large number of population. The current estimate of worldwide disease prevalence is more than 38 million HIV infections.

As per estimation of the World Health Organization (WHO), 5 million new HIV infections are occurring each year; 90% of which are occurring in developing countries, generally in sub-Saharan Africa and Southeast Asia.

The HIV seroprevalence rate among pregnant women is highest in sub-Saharan Africa, which ranges from 35% to 45%. The seroprevalence rate in pregnant women in Asia is 2%, and the vertical transmission of HIV from infected mothers to infants is 24% without breast-feeding. It has been estimated that Indian mothers infected with HIV can have a transmission rate as high as 48% with breast-feeding. More than 4.4 million children are infected worldwide, and the death of 3.2 million children has been reported due to HIV infection.

**India:** The first incidence of HIV infection was documented among sex workers in Chennai, Madurai, and Vellore of Tamil Nadu in 1986–1987. The first case of AIDS was detected in the year 1986 from Mumbai. Since then, HIV infection has been documented from each part of India. The National AIDS Control Organisation (NACO), India has estimated that by the year 2008, nearly 2.4 million people were living with HIV, next only to South Africa. The national HIV prevalence is varied from 0.4% to 1.3%.

Distribution of HIV epidemic in India is varied and is based on the prevalence of HIV infection in the high- and low-risk groups. Different states in India have been classified as high-, medium-, and low-prevalence areas. Tamil Nadu, Andhra Pradesh, Karnataka, Maharashtra, and Goa are classified as high-prevalence states with HIV prevalence over 1% even in low-risk population.

Both HIV-1 and HIV-2 have been shown to occur in India. Various studies have shown a high prevalence of subtype C in India. Nearly 78.4% strains in north India and 95% of strains in Kolkata and south India have been shown to be HIV 1C subtype.

### ► Reservoir, source, and transmission of infection

HIV is primarily a human infection. Humans infected with HIV and AIDS are the reservoir of infection. The high titer of HIV is found in the blood, semen, and vaginal secretions of the infected people; hence these are important sources of infection. The virus is also present in the breast milk of an infected mother.

**Transmission of HIV infection:** HIV infection occurs either by the transfer of HIV-infected cells or free HIV not associated with cells. HIV transmission occurs in following ways (Fig. 68-4):

**Sexual transmission:** HIV is transmitted primarily through sexual contact and constitutes more than 70% of the HIV transmission. Sexual transmission is more common in heterosexual women and men than in homosexual men worldwide. Varied sexual behaviors, such as (a) more number of sexual partners, (b) sex with commercial sex workers, homosexuals, and (c) receptive anal sex have been reported to be increasingly associated with HIV infection. The presence of other sexually transmitted disease, such as gonorrhoea, syphilis, or herpes simplex virus type 2 infection increases the risk of sexual HIV transmission by more than 100 times. This is due to preexisting inflammation and ulcers caused by these diseases, which

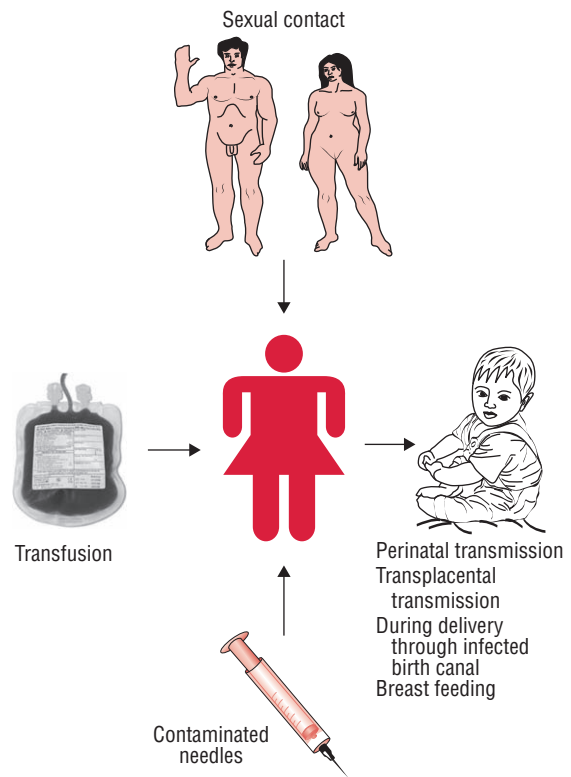

FIG. 68-4. Transmission of HIV infection.

facilitate the transfer of HIV through mucosa. The risk to HIV significantly increases with an increase in the number of sexual contact with multiple partners.

**Transmission by blood transfusion:** HIV is also transmitted by transfusion of infectious blood or blood products, such as serum, plasma, and cells from HIV-positive individuals. It can also be transferred by the organs donated from the HIV-positive individuals.

HIV among health workers has also been documented following a needle stick injury with contaminated blood. However, the reported cases are relatively few, and the estimated risk of transmission is as low as 0.3%.

**Parenteral transmission:** Parenteral transmission occurs largely among IV drug users. Injection users of illicit drugs are commonly infected through the use of contaminated needles. IV drug users constitute a substantial proportion of new cases of HIV in north-eastern states of India, Manipur. The prevalence of HIV among injecting drug users in Manipur is increasing rapidly: from 2–3% in 1989 to more than 50% in 1991 and nearly 75% in early 2000. This increase is due to transmission of HIV through sharing of needles when injecting equipment is shared.

**Mother-to-child transmission:** Mother-to-infant transmission can occur by vertical transmission or by perinatal transmission. Vertical HIV infection occurs in the following ways:

1. The fetus *in utero* can be infected by vertical transmission of virus through the placenta or through the amniotic membrane if the membranes are infected or inflamed. Vertical

transmission is most common during delivery of the baby of the infected mother. The risk of vertical transmission is greatly increased with an increase in duration of contact with the maternal blood and cervical vaginal secretions.

2. Perinatal infection in HIV occurs during the birth process or through breast-feeding. Transmission of HIV during breast-feeding usually occurs by 6 months. Several studies have shown that nearly one-third to half of perinatal HIV infection in Africa is caused by breast-feeding. Untreated women infect 13% and 40% children in Europe and Africa, respectively. Mother-to-infant HIV transmission rate varies between 36% and 40% in India. Relatively, the rate of postnatal transmission in Africa and other developing countries is higher because of the practice of breast-feeding.

Sexually active person, both heterosexual and homosexual, IV drug abusers and their sexual partners, and the newborns of HIV-positive mothers are at highest risk for HIV infection.

### Key Points

- HIV is not transmitted by touching, hugging, kissing, casual contact, coughing, and sneezing.
- It is also not transmitted by bite of insects or through water, food, utensils, or by swimming in swimming pools.

## Laboratory Diagnosis

Laboratory diagnosis of HIV infection is useful to:

1. Confirm the diagnosis of AIDS
2. Detect the individuals with HIV infection
3. Identify carriers who may transmit infections to others
4. Perform seroepidemiological studies in the community

### Specimens

These include serum and plasma for HIV serology and lymphocytes for isolation of HIV.

### Isolation of the virus

Virus isolation is not a routinely used method for diagnosis of HIV infection because it is time-consuming and laborious. It is used mostly for research purpose. The virus can be isolated mostly from lymphocytes in the peripheral blood and occasionally from bone marrow, plasma, and other body fluids. In patients with AIDS, high titer of virus is found in the plasma and in lymphocytes than in the peripheral blood. Viruses are found mostly within CD4 cells.

**Cocultivation:** It is the most sensitive method for isolation of virus. It is performed by cocultivating potentially infected and uninfected mononuclear cells to facilitate the replication of HIV. The viral growth in culture fluid is demonstrated by the presence of HIV p24 antigen and HIV reverse transcriptase. The test becomes positive after 7–14 days of culture or even may require a longer period of 28 days. The virus titer in asymptomatic infection is low, hence may not be positive for virus by

culture. Viral culture is useful for detection of high virus titer, which is found early in infection before the presence of HIV antibodies.

### Serodiagnosis

Serodiagnosis includes demonstration of antibodies and viral antigens.

#### Demonstration of antibodies

Detection of specific antibodies to HIV in serum is the most commonly used method for serodiagnosis of patients with HIV and AIDS. Detectable level of antibodies is demonstrated in most individuals within 6–12 weeks after infection and in all the individuals within 6 months of infection.

### Key Points

- The time interval before an antibody appears in the serum is known as *window period*, and it may vary from 3 to 4 weeks.
- The serum of the patient tested during this period is negative for serum antibodies but positive for viral antigens.

The diagnosis of HIV infection is established by demonstration of specific antibodies to envelope glycoproteins gp41, gp120, and gp160 and to viral core p24 antigens. The antibody response against these viral proteins is variable during the progression of HIV infection to AIDS. Antibodies to envelope glycoproteins persist in the serum, but those directed against Gag protein (p17, p24, p55) decrease.

The antibody-based serological testing in HIV is of two types: (a) screening tests and (b) supplementary or confirmatory tests.

**Screening tests:** Screening tests are otherwise known as ERS which is an acronym for enzyme-linked immunosorbent assay (ELISA), rapid test, and simple test. These tests are usually highly sensitive tests and are used for initial screening of the serum samples for the presence of HIV antibodies.

**ELISA:** ELISA is the most frequently used test for detection of both HIV-1- and HIV-2-specific antibodies in the serum. This test is highly sensitive and specific, and commercial ELISA kits are available, which detect both HIV-1 and HIV-2 antibodies in the serum. ELISA can also be used for demonstration of antibodies in the saliva. This is very useful for testing injectable drug users from whom it may be difficult to collect blood due to collapsed blood vessels. ELISA in HIV serology are of four types: first generation, second generation, third generation, and fourth generation depending on the nature of the antigen used and detecting both antibodies and antigen in the serum (Table 68-4).

**Rapid tests:** Rapid tests include dot blot assay, latex agglutination, gelatin agglutination, HIV spot, and comb test, etc. These tests are simple tests, which can be performed in any laboratory without requiring any expensive instrument or skilled manpower. Moreover, test results can be read rapidly within 30 minutes of receipt of the specimen.

TABLE 68-4

## ELISA in HIV

Types of ELISA	Source of antigen	Antigen/Antibody detection
First-generation ELISA	Cultured virus lysate	Detection of antibodies
Second-generation ELISA	Recombinant antigen	Detection of antibodies
Third-generation ELISA	Synthetic peptides	Detection of antibodies
Fourth-generation ELISA	A mixture of synthetic peptides and recombinant glycopeptides	Detection of both antigens and antibodies

**Simple tests:** These tests are simple, do not require any expensive equipment, and can be performed within 1 or 2 hours.

**Supplementary or confirmatory tests:** These tests are used as confirmatory tests for detection of HIV antibodies. These tests are designed for a higher specificity than the screening tests, hence are used as the test of choice to verify the results of screening tests. Western blot, line immunoassay, and indirect immunofluorescence assay are the most commonly used serologic confirmatory tests.

**Western blot:** It is the most common confirmatory test used in HIV serology. In this test, HIV viral antigens are separated as gp160, gp120, p66, p55, p51, gp41, p31, p24, p17, and p15 depending on their electrophoretic mobility by polyacrylamide gel electrophoresis. These antigens are then blotted onto strips of nitrocellulose paper. These strips are treated with test serum. Antibodies to these HIV proteins, if present in test serum, combine with different fragments of HIV and then react with enzyme conjugated antihuman globulin. These strips are washed, followed by addition of a suitable substrate, which produces colored bands. The position of the colored band on the strip indicates the antigen with which the antibody has reacted (Fig. 68-5). The demonstration of multiple bands indicates a positive test.

- The test is considered positive if it shows bands against at least two of the three viral proteins, namely, p24, gp41, and gp120 or gp160.
- The test is also considered positive if multiple bands are seen with multiple proteins, which are encoded by three genes (*gag*, *pol*, and *env*). This represents p24 of *gag* gene core protein, p31 of *pol* gene reverse transcriptase, gp41, gp120 or gp160 of *env* gene surface antigens.

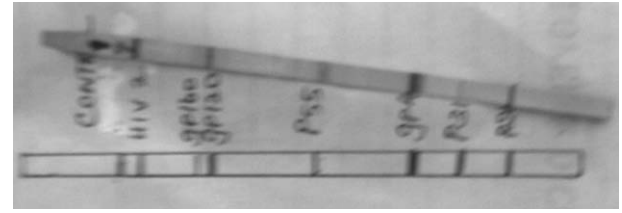

FIG. 68-5. Western blot for diagnosis of HIV infection.

- The development of bands at one site as with p24 or gp120 is considered equivocal and may happen in early infection and also may be nonspecific.
- Absence of any band indicates negative test.

It was earlier practice to confirm positive result of any one screening test by Western blot, but since the test is cumbersome, expensive, and is not readily available, other strategies are available for confirmation of the cases. So the practice followed now is to perform either two different types of ELISA or an ELISA with any of the rapid tests. If a serum is positive for HIV antibodies by both these tests, the serum is then considered positive for HIV. In case of doubt, serum samples are retested after a period of 1 or 2 months.

**Other confirmatory tests:** Line immunoassay in principle is similar to Western blot; however, it differs from Western blot by having artificial HIV antigens used on the strips than using viral lysis protein separated by polyacrylamide gel electrophoresis. Indirect fluorescent antibody (IFA) is another test used as a confirmatory test.

### Demonstration of viral antigen

The antibody sandwich ELISA using specific monoclonal antibodies to HIV p24 is used to detect the viral capsid core antigen (p24 antigen) in blood. The p24 antigen appears much earlier than HIV antibodies during acute HIV infection, hence can be detected during window period, during which antibodies are not demonstrated in the serum. The p24 antigen appears usually 16 days after infection. The antibody sandwich ELISA using specific monoclonal antibodies to HIV p24 is used to detect p24 antigen. The p24 antigen often becomes undetectable after HIV antibodies develop in the blood. This is due to formation of immune complexes by p24 with the antibodies. However, p24 antigen may appear later in the course of infection, suggesting a very poor prognosis.

Specific tests useful for laboratory diagnosis of HIV infection and AIDS are summarized in Table 68-5.

TABLE 68-5

## Specific tests for laboratory diagnosis of HIV infection and AIDS

State of infection	Antibody		Antigen p24	Viral genome	Virus isolation
	ELISA	Western blot			
Window period	—	—	+	+	++
Acute infection	+	+ (Partial p24 and/or gp120)	+	+	±
Asymptomatic infection	+	+ (Full pattern)	—	+	+
ARC and AIDS	+	+ (Absence of p24 antibody)	+	+	+

## Molecular Diagnosis

The molecular methods include reverse transcriptase polymerase chain reaction (RT-PCR), nucleic acid-based amplification (NASBA), transcription-mediated amplification (TMA), and branched chain DNA (bDNA). These methods are useful for quantitative estimation of viral load in the plasma. In a positive test, a five- or threefold change in the viral load indicates reliably a significant change in children younger than 2 years or in those older than 2 years, respectively. These tests should not be used until the diagnosis of HIV has been confirmed with a nonquantitative serodiagnostic method because these tests may falsely show low viral loads in individuals who are HIV negative.

HIV DNA PCR is a sensitive method for detection of HIV provirus present inside mononuclear cells by employing oligonucleotide directed at highly conserved regions of the virus genome. The advantage of this test is that it can be used to diagnose HIV within 24 hours of infection and it has a sensitivity and specificity of 95% and 97%, respectively.

The RT-PCR and NASBA for plasma are sensitive methods for detection of HIV-1 subtype B viruses, whereas bDNA method is sensitive for detection of other HIV subtypes.

## Monitoring status of HIV infection

The laboratory monitoring of the status of HIV infection can be carried out by analysis of (i) T-cell subset, (ii) measurement of HIV RNA, and (iii) measurement of B2 microglobulin and neopterin.

**CD4+ T cell count:** This is an important indicator for monitoring HIV infection. This count reflects the immunological competence of the patients with HIV or AIDS. A rapid decrease in the CD4 count in adults and in infants is a poor prognostic sign and requires the initiation or alteration of antiviral therapy. The absolute number of CD4 lymphocytes and the ratio of helper T inducer lymphocytes (CD4:CD8 ratio) are very low in HIV-infected people. The CD4:CD8 T-cell ratio is reversed to 0.5:1 from a normal level of 2:1. If the CD4 count is below 500/ $\mu\text{L}$ , it indicates progression of the disease and hence requires specific therapy against HIV. When the count falls below 200/ $\mu\text{L}$ , it indicates a very poor prognosis and shows the increased risk for serious infection of patient, particularly opportunistic infections.

**Measurement of HIV RNA:** HIV RNA level in serum is an important predictive marker of disease progression and are used as prognostic marker to monitor the effectiveness of anti-HIV therapies. The test is also useful for early diagnosis of HIV infection in infants born to infected mothers.

**Measurement of B2 microglobulin and neopterin:** B2 microglobulin and neopterin can be demonstrated in the serum or urine of HIV-infected people. The titer is low in asymptomatic HIV infection, but is elevated with the progression of HIV disease.

## Other tests

Tuberculin test or other tests for cell-mediated immunity is negative, indicating a depressed cell-mediated immunity. Both IgE

and IgA serum levels are elevated in the blood. Hematological parameters are altered in patients with HIV. There is a leukopenia with lymphocyte count less than 400/ $\mu\text{L}$  and thrombocytopenia in patients with AIDS. Hyperimmunoglobulinemia is associated with the progression of disease. Hypoimmunoglobulinemia is observed in end-stage disease and is associated with poor prognosis. Thrombocytopenia is a common finding in patients with HIV. Anemia occurs in as many as 25% of cases at diagnosis and occurs in 80% of cases after sometime. Neutropenia is observed in 10% of early asymptomatic HIV infections and in 50% of patients with AIDS.

## Strategies for HIV testing in India

The following are the three different strategies followed for HIV testing in India:

**Strategy 1:** In this strategy, test serum is subjected once to ERS test, and if positive the sample is considered as HIV infected and if negative the serum is considered to be free of HIV. For this purpose usually highly sensitive and very reliable diagnostic kits are used. This strategy is used for screening of blood, organ, and tissue before transfusion and transplantation.

**Strategy 2:** In this strategy, a serum sample is considered negative if the first ERS test report reports it so. But if positive, it is retested with a second ERS test based on different antigen preparation and different test principles. The serum specimen if also found positive with second ERS test, it is reported as positive, and otherwise it is considered as negative. This strategy is used for HIV surveillance.

**Strategy 3:** It is similar to strategy 2, but with an added confirmation by a third ERS test. The third test should be based on different antigen preparation or test principle. A serum showing positive result on all three ERS tests is reported positive. The test is considered equivocal if the serum is negative in the third ERS. In such cases, serum specimens are retested on collection after 3 weeks. If this specimen also shows an equivocal result, the person is considered to be negative for HIV antibodies. This strategy is used for diagnosis of HIV infection in asymptomatic persons. The tests used in second and third strategies are of higher specificity in order to rule out any false positivity.

Interpretation of various laboratory tests used in the diagnosis of HIV infections is summarized in Table 68-6.

## Treatment

Antiretroviral treatment is the mainstay in HIV treatment. The goals of antiretroviral therapy are to inhibit replication of HIV and to reduce morbidity and death.

## Anti-HIV drugs

The anti-HIV drugs can be broadly classified as: (a) nucleoside analog reverse transcriptase inhibitors (NRTIs), (b) non-nucleoside reverse transcriptase inhibitors (NNRTIs), or (c) protease inhibitors. Antiretroviral agents against HIV are summarized in Box 68-1.

TABLE 68-6

### Interpretation of laboratory tests in diagnosis of HIV

Test	Purpose
<b>Serology</b>	
<b>Antibody demonstration</b>	
ELISA	Screening test
Rapid tests: dot blot assay, latex agglutination, HIV spot, and comb test	Screening test
Western blot	Confirmation test
Indirect immunofluorescence test	Confirmation test
<b>Antigen detection</b>	
p24 antigen	Early marker of infection
<b>Molecular diagnosis</b>	
Branched-chain DNA	Detection of virus in blood
Viral RNA RT-PCR	Detection of virus in blood
<b>Isolation of virus</b>	
CD4: CD8 T-cell ratio	Test not readily available
	Correlates of human immunodeficiency virus disease

#### Box 68-1

### Antiretroviral drugs against HIV

#### Nucleoside reverse transcriptase inhibitors (NRTIs)

- Zidovudine (AZT)
- Didanosine (ddI)
- Zalcitabine (ddC)
- Lamivudine (3TC)
- Stavudine (d4T)
- Abacavir (1592)

#### Non-nucleoside reverse transcriptase inhibitors (NNRTIs)

- Nevirapine (NVP)
- Delaviridine
- Efavirenz

#### Protease inhibitors (PI)

- Ritonavir
- Indinavir
- Saquinavir
- Nelfinavir
- Amprenavir

#### Nucleotide reverse transcriptase inhibitor

- Tenofovir

#### Fusion transcriptase inhibitor

- Enfuvirtide

**Nucleoside analog reverse transcriptase inhibitors (NRTIs):** Azidothymidine (AZT), didanosine (DDI), and other nucleoside analogs inhibit the enzyme reverse transcriptase and alter their incorporation into DNA to cause chain termination. These agents prevent the spread of the virus to uninfected cells.

AZT is recommended for treatment of asymptomatic or mildly symptomatic people with CD4 count of less than 500/ $\mu\text{L}$ . This is also recommended for treatment of pregnant women to reduce the possibility of transmission of the virus to the fetus. The toxicity associated with high doses of AZT and the emergence of resistance to AZT is the main disadvantage of monotherapy with AZT. Zidovudine is also used effectively to reduce significant transmission of HIV from mother to infant. The treatment decreases vertical transmission at all levels of maternal viral load.

**Non-nucleoside reverse transcriptase inhibitors (NNRTIs):** NNRTIs, such as nevirapine, delaviridine, and efavirenz, inhibit the enzyme by blocking the morphogenesis of the virion by inhibiting the cleavage of the Gag and Gag core polyproteins. This in turn prevents activation of the virion.

**Protease inhibitors:** Protease inhibitors, such as ritonavir, indinavir, saquinavir, nelfinavir, and amprenavir, prevent the maturation of viral particle during late stage of viral replication. Monotherapy with antiretroviral therapy failed to produce significant clinical benefits including survival of the patient. The failure is partly due to the development of drug-resistant variants of HIV because resistance develops rapidly during monotherapy and cross-resistance between related drugs is also being increasingly reported.

#### Key Points

- Therapy with combination of antiretroviral drugs, referred to as HAART, is effective in inhibition of HIV replication.
- HAART, a strategy similar to the treatment of tuberculosis, has improved efficacy of the therapy, minimized toxicity following therapy, and delayed emergence of drug resistance (Box 68-2).
- It is usually recommended to initiate double and triple drug therapy with two NRTIs Or two NRTIs + an NNRTI or a protease inhibitor.

Multidrug therapy reduces morbidity due to the disease and death in many patients due to AIDS is delayed.

### Prevention and Control

These include the following steps: (a) health education, (b) screening of blood and blood products, (c) infection control, and (d) vaccine development.

#### Box 68-2

### Highly active antiretroviral therapy (HAART)

#### Combination of therapy

- Indinavir/AZT/3TC
- Ritonavir/AZT/3TC
- Nelfinavir/AZT/3TC
- Nevirapine/AZT/ddI
- Nevirapine/indinavir/3TC



### ► Health education

Health education plays a key and important role for the prevention of AIDS in the absence of a suitable vaccine. Health education is aimed at behavioral changes and maintenance of a lifestyle that minimizes or eliminates the risk of transmission. Health education includes the following:

- Safe sexual practice by using a condom, which prevents transmission of the virus.
- Not sharing unsterile needles or syringes.
- Information to HIV-positive women regarding the risk of vertical transmission of HIV to infants.

### ► Screening of blood and blood products

It is essential to screen potential blood donors before they donate blood or blood products before use. The infected persons who are tested positive for HIV should refrain from donating blood, plasma, body organs, other tissues, or sperm. The blood of the donors should be screened for HIV-1 and HIV-2 antibodies by screening tests, such as ELISA. Regular screening of blood for HIV antibodies before transfusion has reduced considerably the transmission of HIV by contaminated blood.

### ► Infection control

Infection control methods include the use of universal blood and body fluids precautions. These universal precautions include wearing protective clothings, such as gloves, masks, gown, etc., and using other barriers to prevent exposure to blood products. These also include disinfection of contaminated surface with 10% household bleach, 70% ethanol or isopropanol, 2% glutaraldehyde, 4% formaldehyde, or 6% hydrogen peroxide. Washing clothes in hot water with adequate detergents is effective to kill HIV.

### ► Vaccine development

A safe and effective vaccine is yet to be available against HIV. An ideal HIV vaccine is that which would:

- prevent acquisition of the virus by an adult during sexual intercourse,
- prevent transmission of virus to infants of HIV-positive mothers, and
- also block the progression of the disease.

There are many scientific obstacles to the development of AIDS vaccine. This is mainly due to various problems unique to the HIV as mentioned below:

1. Antigenic diversity and hypervariability of the virus, as the antigenicity of the virus changes readily through mutation.
2. Transmission of the disease by mucosal route—initial protection should require the production of secretory antibodies to prevent sexual transmission and acquisition of the virus.
3. Transmission of the virus by infected cells.
4. Latency of the virus—the virus can be spread through syncytium and remain latent, thereby remaining protected from antibodies.
5. Integration of the virus genome into the host cell chromosome.
6. Rapid emergence of viral escape mutants in the host—the high error rate of the viral reverse transcriptase leads to continuous mutations in the HIV genome.

### Vaccines

Most of the HIV vaccines have been evaluated by using gp120 or its precursor gp160 as immunogen. The gene for this protein has been cloned, expressed in different eukaryotic systems, and developed as a subunit vaccine. In India, the National AIDS Research Institute (NARI), Pune is evaluating DNA+ pox virus (canary pox, fowl pox) and MVA (modified vaccinia Ankara), a highly attenuated host-range-restricted strain of vaccinia virus. The vaccine has undergone phase I clinical trial with AAV (adeno-associated virus) AIDS vaccine in 2005. The second AIDS vaccine clinical evaluation is being set up at TRC (Tuberculosis Research Centre), Chennai.



### CASE STUDY

A 25-year-old college student, resident of an area endemic for HIV, in Manipur was admitted with several complaints. He had serious bouts of diarrhea with a history of marked weight loss during the past one year. He was found to be a drug addict. His stool samples were positive for oocysts of *Cryptosporidium parvum*. The serum was tested positive for HIV antibodies by ELISA. The person was diagnosed to be suffering from AIDS.

- What are the other laboratory tests you will perform to confirm the diagnosis?
- What are the other opportunistic infections associated with AIDS?
- How did the boy acquire the infection?
- What do you mean by the term ART. Describe the recent developments in the field?

# Slow Viruses and Prions

## Introduction

Slow infectious diseases are a large group of related neurodegenerative conditions, which affect both humans and animals. The diseases are caused by a heterogeneous group of agents consisting of conventional viruses and the unconventional agents that are called *prions*.

The term “slow” refers to the disease process and not to the replication of the viruses that cause the slow disease. Replication rate of virus is similar to that of most other viruses.

A list of slow infectious diseases caused by prions and conventional viruses is presented in Table 69-1.

## Slow Diseases Caused by Prions

The agents causing slow diseases were earlier called as slow virus, infectious protein, infectious amyloids, or crystal protein. These agents are now being named prions, and this term has gained wide acceptance, replacing all the previously used terms. The prions are unconventional agents that are not viruses.

TABLE 69-1

Slow diseases caused by prions and conventional viruses

Agent	Diseases
<b>Humans</b>	
Prion	Kuru
Prion	Creutzfeldt–Jakob disease (CJD)
Prion	Variant CJD
Prion	Gerstmann–Straussler–Scheinker syndrome
Prion	Fatal familial insomnia and sporadic fatal insomnia
Virus	Subacute sclerosing panencephalitis
Virus	Progressive multifocal leukoencephalopathy
Virus	Acquired immunodeficiency syndrome (AIDS)
<b>Animals</b>	
Prion	Scrapie
Prion	Bovine spongiform encephalopathy
Prion	Feline spongiform encephalopathy
Prion	Transmissible mink encephalopathy
Prion	Chronic wasting disease of deer, mule, and elk
Virus	Visna

## Key Points

- Prions are small protein-containing infectious particles with no detectable nucleic acid.
- The protein is yet to be characterized fully and appears to be a modified host protein.

The diseases caused by prions are a large group of related neurodegenerative conditions, which affect both humans and animals. These diseases belong to a family of diseases known as the transmissible spongiform encephalopathies (TSEs).

There are six human TSEs caused by prions: (a) kuru, (b) Creutzfeldt–Jakob disease (CJD), (c) variant CJD (vCJD), (d) Gerstmann–Straussler–Scheinker (GSS) syndrome, (e) fatal familial insomnia (FFI), and (f) sporadic fatal insomnia.

Animal TSEs caused by prions include (a) scrapie and visna (diseases of sheep), (b) bovine spongiform encephalopathy (BSE; mad cow disease), (c) transmissible mink encephalopathy, and (d) chronic wasting disease of deer, mule, and elk.

Transmissible spongiform encephalopathies in humans caused by the prions show following characteristics:

1. Long incubation period of several years.
2. Course of illness lasting for months to years.
3. A progressive debilitating neurological syndrome that is invariably fatal.
4. Associated with pathological changes typically restricted to the central nervous system (CNS).
5. Absence of specific immunological response in the host.
6. The agents are resistant to conventionally used inactivation methods.

## History

Kuru was the first human disease known to be caused by a slow virus, or prion (1959). This condition was found among “Fore” people, a tribe living in the remote highlands of New Guinea. This virus was linked to ritualistic cannibalism prevalent among these tribal people. Hallow (1959) suggested that kuru could be a possible human form of scrapie, a slow viral disease seen in sheep. Gajdusek and his colleagues (1966) first demonstrated that kuru was transferable to chimpanzee after a long period of incubation, for which they were awarded the Nobel Prize. Since then many TSEs, linked to slow viruses, are being described both in humans and animals.

## Properties of the Prions

Prions are small protein-containing infectious particles with no detectable nucleic acid. They were suspected to be viruses but otherwise do not conform to the standard definition of viruses. They differ from the viruses in their many properties (Table 69-2). The prions show following characteristics:

1. Prions like viruses are filterable.
2. They apparently lack any virion structure or genome.
3. Unlike viruses, they are unusually resistant to inactivation by heat, disinfectants, and radiation.
4. They do not elicit any specific immune response in the infected host.

### ► Morphology

Different hypotheses have been suggested for the makeup of prions. Initially many research workers considered prions to be (a) nucleic acid only, (b) protein only, (c) lacking both protein and nucleic acid, and (d) polysaccharide. Currently, the most widely accepted hypothesis is the “protein only hypothesis” first suggested by Griffith (1965) and re-established subsequently by Prusiner to indicate that scrapie is related to a proteinaceous infectious particle (PrP). Prions show following features:

- The prion does not contain any nucleic acid.
- It contains an aggregate of hydrophobic glycoprotein, resistant to protease.
- The protein present in humans and other animals is called cellular prion protein. It is similar to glycoprotein in scrapie known as scrapie prion protein, which has a molecular weight ranging from 27,000 to 30,000 Da. It is similar to scrapie prion protein in its protein sequence but differs from it in being sensitive to protease (scrapie protein is protease resistant) and being present in plasma membrane (scrapie prion protein is present in cytoplasmic vesicles).

### ► Prion replication

In experimental animal studies carried out in chimpanzees, Prusiner demonstrated conclusively that the prion, an aberrant

protein, could cause disease, for which he was awarded Nobel Prize in 1997. Prusiner hypothesis suggests that prions do not contain any nucleic acid. The normal prion protein known as *prion protein cellular* or PrP<sup>C</sup> has a significant amount of helical configuration. In its alpha-helical configuration, PrP<sup>C</sup> is usually sensitive to degradation by the activity of enzyme protease. Disease occurs when the PrP<sup>C</sup> is reconfigured into the beta-sheet configuration known as *prion protein scrapie* or PrP<sup>Sc</sup>, which is resistant to degradation by protease.

These abnormal proteins are resistant not only to protease degradation but also to radiation, heat, and other agents that destroy proteins. These aggregate into filaments that disrupt neuron functions and cause death of cells. Both the normal alpha-helical form and the abnormal beta-pleated sheet form have the same amino acid sequence but differ in their configuration.

### ► Other properties

Prions, unlike viruses, are unusually resistant to heat at 80°C, ultraviolet radiation, and disinfectants, such as formaldehyde. They are, however, inactivated by phenol, ether, sodium hydroxide, and hypochlorite.

### Prion Isolation

Prions cannot be cultivated in any tissue culture or isolated in any experimental animal models.

### Pathogenesis and Immunity

Prion disease is transmitted either orally or transcutaneously. But how the prions reach the CNS, their target, is yet to be understood fully. It is believed that a functional immune system is essential for replication of prions and their transport to the reticuloendothelial cells. In these cells, large amounts of prions are present in the follicular dendritic cells as well as in the sympathetic nerve endings. From these sites, the prions reach the CNS—but how they reach the CNS is still an important issue. It is suggested that the prions may reach the CNS via splanchnic nerves at the level of the thoracic spinal cord and via parasympathetic fibers connecting with the brain. The other possible route is by the blood circulation.

In experimental animal studies carried out in chimpanzees, Prusiner demonstrated that scrapie protein (PrP<sup>Sc</sup>) binds to the normal cellular prion protein (PrP<sup>C</sup>) of the host. PrP<sup>C</sup> is found in most tissues of the body but is expressed in higher quantities in the CNS particularly the neurons, the main site of action of prions. PrP<sup>Sc</sup> is ingested by neurons and phagocytic cells but continues to remain intact without being degraded. This may contribute to vacuolation of the neuron, a key pathological change observed in encephalitis caused by prions. In addition, accumulation of prions in high concentration causes damage in the brain tissue. These include the formation of amyloid-containing plaques and fibrils, a proliferation and hypertrophy of astrocytes, and fusion of neurons and adjacent glial cells.

Pathogenesis and transmission of prion diseases in humans are described in Table 69-3.

TABLE 69-2 Differences between prions and viruses

Feature	Prion	Virus
Presence of nucleic acid	No	Yes
Defined morphology	No	Yes
Disinfection by:		
Formaldehyde	No	Yes
Heat (80°C)	No	Most are affected
Ionizing and UV radiation	No	Yes
Disease:		
Incubation period	Long	Depends on virus
Immune response	No	Yes
Cytopathologic effect	No	Yes
Inflammatory response	No	Yes

TABLE 69-3

## Pathogenesis and transmission of prion-related slow diseases in human

Disease	Pathogenesis	Transmission
<b>Kuru</b>	Cannibalism	Ingesting or handling brain tissue
<b>Creutzfeldt–Jakob disease</b>		
Infectious	Contact with or handling prion-containing materials	Cuts in the skin Transplantation of contaminated tissue, such as cornea Use of contaminated medical devices, such as brain electrodes Possibly through ingestion of infected tissue
Hereditary	Mutations in the germ cells	Hereditary predilection
Sporadic	No relationship to any cause	Spontaneous PrP <sup>C</sup> Conversion to PrP <sup>Sc</sup>
<b>Variant Creutzfeldt–Jakob disease</b>	Infection from BSE	Probably by eating meat or nervous tissue from animals with mad cow disease Blood transfusion
<b>Gerstmann–Straussler–Scheinker syndrome</b>	Mutations in the PrP gene	Hereditary/genetic
<b>Fatal familial insomnia</b>	D 178N mutation in the PrP gene, with M129 polymorphism	Hereditary/genetic
<b>Sporadic fatal insomnia</b>	No relationship to any cause	Spontaneous PrP <sup>C</sup> Conversion to PrP <sup>Sc</sup>
<b>Progressive multifocal leukoencephalopathy</b>		Central nervous system demyelination

## ► Host immunity

The prions cause encephalopathy, a condition which denotes a pathologic process in which no tissue inflammation or no immune responses are induced in the host, by which it is differentiated from that of viral encephalitis. In the symptomatic patients, a protein called 14–3–3 brain protein has been detected in the cerebrospinal fluid (CSF).

## Clinical Syndromes

### ► Slow diseases caused by prions in humans

Prions cause following diseases in humans: (a) kuru, (b) CJD, (c) variant CJD, (d) GSS syndrome, and (e) fatal familial insomnia.

**Kuru:** Kuru is a fatal neurological disease described only among Fore tribe inhabiting the highlands of New Guinea. The disease was spread by cannibalistic funeral practice of the tribal population. This involved the ritualistic practice by the closest female relatives and children usually consuming the brain of the person following his or her death. The brain which contained most of the infectious pathogen was the source of infection. Kuru has largely disappeared today because cannibalism has been abolished now among the Fore tribal people. Kuru is a fatal disease characterized by progressive cerebellar ataxia and tremors. The condition manifests initially as difficulty in walking, followed by cerebellar tremor, hence the name *kuru*, which means “trembling in fear”. Eventually the tremor worsens, followed by progressive cerebellar ataxia and eventual death within a year of onset of symptoms. The clinical course lasts for 3 months to 2 years.

**Creutzfeldt–Jakob disease:** CJD is the most common prion disease responsible for nearly 85% of all human prion diseases.

The condition was described by Creutzfeldt (1920) and Jakob (1921), after whom the disease is named. Creutzfeldt–Jakob disease is a subacute progressive encephalopathy characterized by a rapidly progressive dementia, associated with myoclonic jerks. Memory loss, behavioral changes, and confusion are the common clinical manifestations. The condition is also associated with ataxia, aphasia, visual loss, and hemiparesis. The condition progresses and in the terminal stage of the disease, the patient becomes mute and comatose. The condition is associated with extensive cortical spongiosis, gliosis, and neural loss. The condition is invariably fatal and death occurs in about 8 months.

**Variant CJD:** The vCJD is a new disease affecting mostly adults aged 45 years. The condition was first documented in Britain in 1985. It is BSE zoonoses, probably originating from a double species switch from sheep scrapie to BSE and then from BSE to human variant. The vCJD is believed to be caused by ingestion of BSE-infected beef products contaminated by neural tissues. This is because neural tissues have a much higher concentration of PrP<sup>Sc</sup> compared with any other non-neural tissue.

**Gerstmann–Sträussler–Scheinker syndrome:** The condition was originally described in 1936 as affecting humans. The main clinical findings of the condition are slowly progressive limb and truncal ataxia, as well as dementia. Death of the patient usually occurs within 3–8 years of presentation of symptoms.

**Fatal familial insomnia:** Patients with this illness present with intractable insomnia, dysautonomia, dementia, and motor paralysis. Death occurs within 6 months to 3 years following presentation. The clinical presentation of the disease, however, varies widely; hence definitive diagnosis of the condition is made by genotyping.

## ► Slow diseases caused by prions in animals

Prions cause following diseases in animals: (a) scrapie, (b) bovine spongiform encephalopathy, (c) feline spongiform encephalopathy, (d) transmissible mink encephalopathy, and (e) chronic wasting disease of deer, mule, and elk.

**Scrapie:** Scrapie is a prototype prion disease of animals. It is a slow virus disease of the sheep, known for centuries. The infection is transmitted vertically from ewe to lamb and less frequently by direct contact. Incubation period is nearly 2 years. The condition manifests as intense irritation, and to relieve that the infected animals scratch themselves, against trees and rocks, hence the name scrapie. The condition progresses to emaciation and paralysis and finally leads to death of the animal. Autopsy of the infected brain shows spongiform degeneration without inflammation in the brain tissue. The condition has been documented extensively.

**Bovine spongiform encephalopathy (BSE):** Also known as mad cow disease. It is a disease of cattle. The condition has an incubation period of 2–8 years. The disease is relentlessly progressive until the animal dies. The cattle feed containing prion-contaminated meat and bone meal, which was used as a protein source, was the source of infection for transmission of BSE to cattle. The causative agent is believed to be originated from either scrapie affected sheep or cattle with unidentified prion-associated slow virus disease. The mad cow disease, documented in 1986, has been described in cattle in the European countries and in the United States. Till 2004, nearly 190,000 confirmed clinical cases of BSE in cattle have been reported worldwide; the majority of which were from the United Kingdom alone.

**Transmissible mink encephalopathy:** Transmissible mink encephalopathy is a scrapie-like disease of mink. The causative agent is believed to be a strain of scrapie virus, which is transmitted to mink by feeding the animals on scrapie-infected sheep meat.

**Chronic wasting disease of deer, mule, and elk:** Chronic wasting disease is a prion disease of deer, mule, and elk. It is a progressive wasting disease of these animals in the United States.

## Epidemiology

Prion-related diseases are rare but worldwide.

## ► Geographical distribution

Creutzfeldt–Jakob disease is rare but is found throughout the world with an incidence of about one case per million populations. An autosomal dominant pattern of inheritance linked to mutation in the PrP gene is found in nearly 10% cases of familial CJD. Till 2003, a total of 167 definite and probable cases of vCJD have been reported worldwide. Most of the cases of vCJD have been reported in the United Kingdom. The condition is yet to be documented from Asia. Creutzfeldt–Jakob disease syndrome and fatal familial insomnia (FFI) in humans are rare but occur in different parts of the world.

## ► Reservoir, source, and transmission of infection

The spongiform encephalopathies caused by prions may be infectious, hereditary, and sporadic. The CJD, GSS, and FFI are inheritable. The CNS tissue in CJD has the highest concentration of prion agent, hence is the most important source of infection. Unlike the prion disease, in vCJD, lymphoid tissues show highest concentration of prions. Contaminated blood is another source of infection.

### Key Points

Creutzfeldt–Jakob disease is transmitted by:

- cuts in the skin,
- transplantation of contaminated tissue (e.g., cornea),
- use of contaminated medical devices (e.g., brain electrodes),
- possibly through ingestion of infected tissue, and
- blood transfusion.

Brain surgery patients, transplant patients, and surgeons also are at risk for CJD and GSS disease. Sporadic CJD is a type of infection that refers to the occurrence of disease in the absence of an infectious or hereditary form of the disease.

Families with genetic history of the disease have been identified in cases of GSS syndrome. Hosts and pathogenesis of prion-related slow diseases in animals are summarized in Table 69-4.

## Laboratory Diagnosis

The diagnosis of prion diseases is always clinical. It is usually confirmed by the histopathology of the brain tissue showing characteristic histological changes. No serological tests are available, as prions are inert agents and do not elicit any immune response in infected hosts. The prions cannot be detected in the infected tissue by any method including the electron microscopy, antigen detection, and genomic methods, such as DNA probe or polymerase chain reaction (PCR).

Detection of protein 14–3–3 in the CSF by Western blot is a sensitive and specific method in cases of sporadic CJD and in vCJD. A specific reduction in uric acid level in the CSF has been shown in vCJD but not in sporadic CJD, thus facilitating in the differential diagnosis of vCJD.

TABLE 69-4

### Hosts and pathogenesis of prion-related slow diseases in animals

Disease	Host	Pathogenesis
Scrapie	Sheep	Infection in susceptible sheep
Bovine spongiform encephalopathy	Cattle	Infection from contaminated food
Feline spongiform encephalopathy	Cats	Infection from contaminated food
Transmissible mink encephalopathy	Mink	Infection from sheep or cattle in food
Chronic wasting disease	Deer, mule, and elk	Not known

## Treatment

No specific treatment is available for any prion disease.

## Prevention and Control

Prions are highly resistant to inactivation by disinfectants used for other viruses, such as formaldehyde, detergents, and ionizing radiations. Hence, the materials from patients with CJD or vCJD must be handled with special care. For prevention of these diseases, special disinfection protocols have been developed by the World Health Organisation (WHO). These include autoclaving at 15 lbs for 1 hour (instead of 20 minutes) or treatment with 0.1 M sodium hydroxide and 5% hypochlorite solution.

Since cases of blood transfusion-associated CJD have been reported, it is a matter of great concern. However, currently no method including PCR is available for demonstration of the agent in the blood.

## Slow Diseases Caused by Conventional Viruses in Humans

Subacute sclerosing panencephalitis, progressive multifocal leukoencephalopathy (PML), and acquired immunodeficiency syndrome (AIDS) are the three slow diseases caused by conventional viruses in humans.

### Subacute Sclerosing Panencephalitis

The subacute sclerosing panencephalitis is a degenerating disease of the CNS caused by persistent measles infection. It is a persistent infection by a variant measles virus that fails to complete its replication. The disease is characterized by the development of behavioral and intellectual deterioration and seizures after many years (mean incubation period is 10.8 years) of infection by measles. This is a serious and late neurological sequel of measles that affects the CNS.

The condition occurs in about seven in every one million patients. The condition is associated with the presence of an extremely high measles antibody titer in the blood and CSF. Inclusion bodies, which react with antibodies to measles virus, are present in the affected neurons.

## Progressive Multifocal Leukoencephalopathy

Progressive multifocal leukoencephalopathy is a fatal demyelinating disease of the white matter of the brain. The condition is usually fatal. It occurs primarily in persons with compromised cell-mediated immunity, such as patients with AIDS and those receiving immunosuppressive drugs and anticancer therapy.

JC virus or John Cunningham virus (JCV) is the causative agent of PML. The virus following the infection kills oligodendroglia and causes syncytia in astrocytes. Reactivation of the virus in immunocompromised patients causes activation of latent virus, thereby causing the disease. Changes in mental status, alteration in the vision, and weakness are the initial clinical manifestations. The condition progresses rapidly to blindness, dementia, and coma. The patient usually dies within 6 months.

Laboratory diagnosis of the condition is made by PCR for viral genome in the brain tissue or CSF. Serum antibodies to JC are demonstrated in approximately three fourth of normal sera; hence serology is not useful. No specific antiviral treatment is available.

## Acquired Immunodeficiency Syndrome

AIDS caused by human immunodeficiency virus has a long latent period. Hence, the disease is also considered as an example of slow disease with a progressive course and involvement of the CNS. The details of the disease are described in Chapter 68.

## Slow Diseases Caused by Conventional Viruses in Animals

### Visna

Visna is a disease of sheep caused by visna virus, a lentivirus. It is a single-stranded RNA virus with an RNA-dependent DNA polymerase in the virion. Integration of the DNA provirus into the host cell DNA appears to be responsible for persistence of the virus within the host. Clinically, the condition manifests after a long incubation period with a prolonged progressive course. It has an insidious onset with paresis, progressing to total paralysis and death. The viruses are present in the saliva, blood, and CSF of the infected animal. High levels of serum antibodies are present in the serum, but these are not protective.



## CASE STUDY

A 45-year-old adult, resident of the United Kingdom, was admitted with presentations of memory loss, behavioral changes, and confusion. Ataxia, aphasia, visual loss, and hemiparesis were the other manifestations. Subsequently, the patient became comatose and died within a week of admission. The patient was strongly suspected to be suffering from CJD.

- How will you confirm diagnosis of the disease in the laboratory?
- How this disease is transmitted to humans?
- What is variant form of CJD?
- Describe the pathogenesis of prion-mediated diseases.
- List other prion-mediated diseases.

# Miscellaneous Viruses

## Introduction

Miscellaneous viruses described in this chapter include a diverse group of viruses that have been increasingly associated with infections in humans. These viruses include rubella virus, Norwalk virus, viral hemorrhagic fever (VHF) viruses, arena viruses, and coronaviruses including the most recently described severe acute respiratory syndrome (SARS)-associated coronavirus (SARS-CoV).

## Rubella Virus

Rubella virus causes rubella, a mild viral disease affecting the skin, lymph nodes, and less commonly, the joint. It also causes congenital rubella syndrome. It is an RNA virus classified as a rubivirus in the family *Togaviridae*.

## Properties of the Virus

### ► Morphology

Rubella virus shows following features:

- It is a pleomorphic, roughly spherical virus measuring 50–70 nm in diameter.
- It consists of a single-stranded RNA genome, an icosahedral nucleocapsid, and lipoprotein envelope.
- The virus unlike measles and mumps viruses has a positive-strand RNA, therefore does not contain any virion polymerase.
- The envelope contains hemagglutinin peplomers.

### ► Viral replication

Rubella virus penetrates the cell and uncoats, and the positive-strand RNA genome is translated into several structural and nonstructural proteins. RNA-dependent RNA polymerase is an important nonstructural protein, which replicates the genome first by making progeny. The virion acquires its envelope from the outer membrane of cell as the virion comes out of the cell. Both replication and assembly of the virion occur in the cytoplasm of the cell.

### ► Antigenic and genomic properties

Rubella has only one serotype.

### ► Other properties

The virus agglutinates erythrocytes of human, chick, goose, and pigeon at 4°C. The virus is heat sensitive. It is readily inactivated by heating at 56°C, but survives for several years at –60°C. The virus is inactivated by chemicals, such as beta-propiolactone, formaldehyde, chloroform, and ether.

## Virus Isolation

The virus is grown with difficulty in the cell lines. The virus is not cytolytic but produces limited cytopathologic effects in certain cell lines, such as Vero and RK-13 cell lines. In cell line, the replication of rubella prevents the replication of superinfectious picornavirus. This phenomenon is known as *heterologous interference*, which is made use of in detection of rubella virus.

## Pathogenesis and Immunity

### ► Pathogenesis of rubella

Initially rubella virus infects the nasopharynx of the upper respiratory tract and then spreads to local lymph nodes. From there, the virus spreads by the blood throughout the body to the internal organs and skin. The occurrence of mild rash is characteristic. The exact cause of pathogenesis of rash is not known, but may be due to antigen–antibody mediated vasculitis. During prodromal period and for nearly 2 weeks after the onset of rash, the infected persons continue to secrete virus in the respiratory droplets.

### ► Host immunity

Rubella infection is characterized by development of circulating antibodies, which are produced after the phase of viremia and their development correlates with the appearance of the rash. The circulating antibodies limit the spread of the virus in the blood. These antibodies also cross the placenta and protect the newborn from an attack of rubella.

Natural rubella infection usually confers lifelong immunity. Reinfection may occur occasionally after the natural disease or vaccination or exposure to the virus. The formation of immune complexes is suggested to contribute to the development of rash and arthralgia associated with rubella infection.

## Clinical Syndromes

Rubella virus causes rubella and congenital rubella syndrome.

## ► Rubella

Incubation period varies from 14 to 21 days. Rubella is a milder and more subtle disease than measles. A three-day maculopapular or macular rash, which starts on the face and progresses downward to involve the extremities, is the characteristic presentation in symptomatic cases. The rash typically lasts 3 days. Tender lymphadenopathy that affects all the nodes but most commonly affects suboccipital, postauricular, anterior, and posterior cervical nodes is the hallmark of rubella.

In adults, rubella produces a more severe disease with manifestations of arthralgia and polyarthritis, and rarely thrombocytopenia or postinfectious encephalopathy.

## ► Congenital rubella syndrome

Congenital rubella syndrome is the most severe and important complication of rubella, which occurs in the fetus of pregnant women without immunity to the virus. The fetus is at major risk until fifth month of pregnancy. Maternal immunity to the virus due to prior exposure or vaccination prevents spread of the virus to the fetus. In the first trimester, 80% of the infants would be affected, and severity of the disease depends on how early the infection occurs. Cataract, mental retardation, and deafness are the most common manifestations of congenital rubella infection.

The congenital rubella results in congenital anomalies or even death of the fetus. In addition, the infants infected *in utero* continue to excrete rubella virus for up to 1 year. These children constitute a public health hazard because they are considered as an exposure threat to nonimmune pregnant women. The virus can be transmitted to pregnant women from children.

## Epidemiology

Humans are the natural host. The disease is prevalent worldwide. In countries where vaccination is not routinely used, epidemics of rubella occur every 6–9 years. Respiratory droplets are the source of infection. The virus is transmitted from person-to-person by inhalation of respiratory droplets. The infection is usually acquired during childhood. Patients are most contagious during the time of appearance of the rash. The viruses are excreted in the pharynx and in the respiratory droplets from 7 days before until 7 days after the rash. The infection is usually acquired during childhood. The infection can also be transmitted transplacentally from mother to fetus, resulting in congenital infection.

## Laboratory Diagnosis

### ► Specimens

Throat swab in the adult and urine, cerebrospinal fluid (CSF), or throat swab in infants with congenital rubella are the frequently used specimens.

### ► Isolation of the virus

Viruses can be isolated in rabbit kidney (RK-13), rabbit cornea (SIRC), and Vero cells. The virus produces little cytopathic effects.

## Key Points

- In Vero and rabbit cornea cell lines, the virus is usually identified by its ability to interfere with echovirus cytopathic effect. In this method, if the rubella virus is present in the patient's specimen and has grown in cell culture, no cytopathic effect will appear when the culture is superinfected with an echovirus, such as echo 11.
- Rubella virus grown in cell line can also be detected by detection of antigen in cell lines by direct fluorescent antibody method. Virus isolation is rarely used, because isolation of the virus is difficult.

## ► Serodiagnosis

The diagnosis of rubella is usually confirmed by demonstration of rubella antibodies in the serum. Demonstration of specific IgM rubella antibodies in a single acute phase serum sample is diagnostic of rubella. Diagnosis can also be made by demonstration of a fourfold or a greater rise in IgG antibody titer between acute phase and convalescent phase sera by using hemagglutination inhibition test or enzyme-linked immunosorbent assay (ELISA).

In pregnant women, demonstration of IgM rubella antibodies indicates recent infection. Demonstration of 1:8 or greater titer of IgG antibody in serum indicates immunity and consequent protection of the fetus. Demonstration of rubella virus in amniotic fluid collected by amniocentesis indicates a definite rubella infection in the fetus. The presence of IgM antibodies in the serum of the infant indicates recent infection because IgM does not cross the placenta from the mother as does IgG. Confirmation of diagnosis of congenital rubella syndrome in an infant after 1 year with serology alone is very difficult.

## Treatment

There is no antiviral therapy.

## Prevention

Preventive measures include vaccination and administration of immunoglobulins.

## ► Vaccination

Prevention of rubella is best carried out by immunization with live attenuated vaccine. The main objective of rubella vaccination program is to prevent congenital infection by decreasing the number of susceptible people, especially children. Vaccination causes a significant reduction of the likelihood of exposure of the pregnant women to the virus (refer the box Vaccine).

Immunoglobulins can be given to pregnant women in the first trimester of pregnancy who have been exposed to a known case of rubella and for whom termination of pregnancy is not an option. Nevertheless, cases of congenital rubella syndrome have occurred in infants born to mothers who received immunoglobulins shortly after exposure. No adequate treatment is available for pregnant women exposed to rubella.



## Vaccines

**Live rubella vaccine** contains live, cold-adapted RA-27/3 vaccine strain grown in human diploid cells. The virus is usually administered as measles, mumps, and rubella vaccine (MMR vaccine). The vaccine is very effective and induces long-lasting humoral and cellular immunity. It causes few side effects, such as transient arthralgia in some women. The vaccine also induces production of respiratory IgA, thereby interrupting the spread of virus by nasal droplets. The use of vaccine has resulted in significantly reduced incidence of rubella and congenital rubella syndrome worldwide.

- This vaccine is usually given subcutaneously to children 15 months of age.
- It is also recommended for unimmunized young adult women if they are not pregnant and for those women who will not conceive for the next 3 months.
- It is contraindicated for use in pregnant women and in immunocompromised patients.

## Norwalk Virus

Norwalk virus is one of the most common causes of viral gastroenteritis in adults.

### Classification

Norwalk virus is a calcivirus in the family Calciviridae. The calciviruses are small, nonenveloped, single-stranded RNA viruses. The calciviruses although show many features similar to those of picornaviruses, they differ from those by having a large genome and by having distinct spikes on the surface. There are two important calciviruses, which cause infection in humans: Norwalk virus and Hepatitis E virus. The latter virus is described in Chapter 66.

### Properties of the Virus

Norwalk virus shows following features:

- Norwalk viruses are round viruses with a ragged outline.
- The genome is a nonsegmented, single-stranded, positive-polarity RNA genome. The RNA genome is present in a 27-nm naked capsid consisting of one 60,000-Da capsid protein. The genome does not contain any virion polymerase.
- Ten prominent spikes and 32 cup-shaped depressions can be seen on the virion by microscopy.

#### ► Viral replication

The Norwalk virus replicates in the cytoplasm with release of viral particles on cell destruction. The virus is presumed to replicate in a manner similar to that of picornaviruses.

#### ► Antigenic and genomic properties

The number of serotypes is not known.

#### ► Other properties

Norwalk viruses are stable and can survive with freezing or at temperatures of up to 140°F. They are also resistant to inactivation by chlorination of water and to drying in the environment.

### Pathogenesis and Immunity

Norwalk viruses are highly contagious. As low as 100 viral particles can establish infection, which is typically limited to the mucosal cells of the intestinal tract. Infection is characterized by damage to microvilli in the small intestine, causing malabsorption. The virus-mediated changes in gastric mucosa and delayed gastric emptying cause vomiting. It is a noninvasive virus and does not cause invasion of the colon; therefore leukocytes or erythrocytes in the feces are typically absent. No histopathological lesions are seen in the gastric mucosa.

#### ► Host immunity

Norwalk virus infection confers a brief and short immunity. Recurrent infection occurs throughout life, because of the absence of long-term immunity, lack of cross-strain immunity, and because of the diversity of Norwalk virus strains.

### Clinical Syndromes

Norwalk viruses cause gastroenteritis in adults. The illness in symptomatic cases typically begins after an incubation period of 24–48 hours. The illness is characterized by sudden onset of nausea, vomiting, and watery diarrhea. It is accompanied by low-grade fever, abdominal cramps, and myalgia. Fecal leukocytes are absent. Norwalk virus gastroenteritis is short-lived and typically lasts for 24–48 hours.

### Epidemiology

Norwalk virus gastroenteritis is found worldwide in adults. It is a strict human infection, and humans are the major source of infection. The virus is excreted in the vomitus and feces for several weeks after recovery; hence vomitus and feces are important sources of infection. Infection is transmitted from person to person by ingestion of food or water contaminated with the virus. The infection typically occurs in group settings, such as schools, hospitals, nursing homes, etc.

### Laboratory Diagnosis

Immunoelectron microscopy is used to detect the virus in the stool. Radioimmunoassay (RIA) or ELISA are also used to detect the virus and viral antigen in the stool. Polymerase chain reaction (PCR) is also being evaluated to demonstrate viral genome in the stool for diagnosis of the cases. Both ELISA and RIA are the serodiagnostic tests frequently used to detect specific antibodies to Norwalk virus in the serum.

## Treatment

No specific treatment is available for Norwalk virus.

## Prevention and Control

No vaccine is available against the virus. Strict personal hygiene, such as hand washing is useful to prevent the transmission of the disease.

## Viral Hemorrhagic Fever

Most viral hemorrhagic fevers (VHF) are caused by 12 distinct enveloped RNA viruses that belong to four families: Arenaviridae, Bunyviridae, Filoviridae, and Flaviviridae. The manifestations of the disease vary depending upon the agent causing the disease. Circulatory dysfunction, increased vascular permeability, and diffuse hemorrhage, however, are the serious and terminal manifestations of the disease. With recognition of outbreak of infection caused by Ebola virus near the city of Kikwit, Zaire (Africa), the condition has now received worldwide attention. Viral hemorrhagic fevers caused by different viruses show following features:

1. Viral agents are usually arthropod-borne. Mosquitoes are primarily responsible for transmitting the disease.
2. Person-to-person transmission may occur in many VHFs by direct contact with infected patients, their blood, or their secretions and excretions.
3. Rats and mice are the usual animal reservoirs for many of the VHFs. However, domestic livestock, monkeys, and other primates may also serve as intermediate hosts.
4. In this condition, hemorrhage is typically present in many organs, and effusions are common in serous cavities. Widespread necrosis may be present in any organ system, and varies from modest and focal to massive in extent. Liver and lymphoid systems are usually involved.

Ebola and Marburg are two most important causative agents of VHFs with a mortality of 25–100%. Both viruses are found in Africa and possibly in Philippines. Zaire subtype of Ebola virus has been associated with a high rate of infection, especially in Zaire, Africa. Ebola infection during pregnancy has been consistently fatal. The vector responsible for transmission of Ebola virus is not known, but infected primates appear to be responsible. Later close contact among humans or primates appears to spread the infection. Aerosol transmission is suggested to occur in monkeys.

Incubation period of Ebola and Marburg infection varies from 2 to 14 days. Symptoms are nonspecific. An insidious or sudden onset of fever, chills, malaise, generalized myalgias and arthralgias, headache, anorexia, and cough are some of the common symptoms. The condition may also be associated with sore throat, epigastric pain, vomiting, and diarrhea.

## Key Points

- ELISA for virus-specific immunoglobulin M (IgM) and immunoglobulin G (IgG) is the test of choice for diagnosis of VHFs. The test, however, is negative during the acute stages of Marburg and Ebola virus infections.
- Electron microscopy and enzyme immunoassay are the sensitive and specific assays for direct detection of specific viral antigen in blood and tissues.
- PCR on serum is very useful for detection of infection during the acute stages of infection during which antibodies are not demonstrated in the serum.

No specific antiviral agents are available for the treatment for Ebola or Marburg virus. Avoidance of insect bites from the vectors and that of exposure to rodent sources of infection is the most important measure for preventing the condition. Barrier nursing and needle sterilization in African hospitals are important to eliminate epidemics of Ebola and Marburg diseases.

## Arenavirus

Arenaviruses are enveloped viruses with a helical nucleocapsid. They are spherical to pleomorphic in shape varying in size from 50 to 300 nm. The lipid envelope contains two major glycoprotein components gp1 and gp2, which appear as spike-like or club-like projections. The name *arena* means sand that refers to granules at the surface of the virion that are nonfunctional ribosomes. The arenaviruses include lymphocytic choriomeningitis (LCM) and hemorrhagic fever viruses, such as the Lassa, Junin, and Machupo virus.

## Properties of the Virus

### ► Morphology

Arenaviruses show following features:

- Arenaviruses are the pleomorphic, enveloped viruses (50–300 nm) that have a sandy appearance.
- The genome is a negative-sense RNA that contains two subgenomic segments, namely, S (small segment, measuring 1.3 million bases) and L (large segment, measuring 2.4 million bases).
- The virion consists of beaded nucleocapsid with two single-stranded RNA circles. The strand is a negative-sense RNA that encodes for a Z protein and for the viral RNA-dependent RNA polymerase.
- The segment encodes for the glycoprotein precursors and for the N protein that binds to the positive-sense RNA segments. The presence of internal granular structures 20–25 nm in size is the distinctive property of arenavirus. These granular structures on electron microscopy appear sand-like. These structures are believed to be host-cell-derived ribosomes, which are incorporated into the virus during budding. These structures do not appear to play any role in replication of viruses.

## Viral Isolation

The arenavirus, such as Lassa virus, can be isolated in cell culture using the E6 clone of Vero cells or in suckling mice.

## Pathogenesis and Immunity

Arenaviruses primarily infect macrophages and cause the vascular damage. Pathogenesis of arenaviruses infection is largely attributed to T-cell immunopathogenesis. T-cell-induced immunopathogenic effect contributes to the exacerbation of tissue destruction.

## Clinical Syndromes

Arenaviruses cause the following diseases: Lymphocytic choriomeningitis, Lassa fever, and South American hemorrhagic fever.

### ▶ Lymphocytic choriomeningitis

Lymphocytic choriomeningitis virus causes lymphocytic choriomeningitis. This is a benign infection, which usually begins with fever, myalgia, and headache. The illness can be biphasic. Fever and more severe headache may recur 2–4 days after recovery from the first phase.

### ▶ Lassa fever

Most infections caused by Lassa fever virus are mild or subclinical. The incubation period varies from 7 to 18 days. The infection begins insidiously with fever, malaise, joint pain, cough, and severe headache. Prostration, dehydration, abdominal pain, facial or neck edema may be seen in severe cases.

### ▶ South American hemorrhagic fever

Lassa, Junin, and Machupo viruses cause South American hemorrhagic fever, which are similar in severity. This has an insidious onset with fever, malaise, myalgia, and lumbar pain. A petechial and/or vesicular palatal enanthem and skin petechiae are found in many patients. The condition may progress within 3–4 days with prostration and remitting fever and mucosal bleeding. Gingival hemorrhage is the characteristic feature. Most patients improve after 1–2 weeks, but one-third of patients may show many complications. These complications include profound mucocutaneous and mucosal hemorrhages, delirium, and convulsions.

## Epidemiology

### ▶ Geographical distribution

Most arenaviruses with exception of lymphocytic choriomeningitis viruses are found in Africa and South America.

### ▶ Reservoir, source, and transmission of infection

Most of arenaviruses are zoonotic and disease is transmitted primarily from rodents to humans. These viruses cause infection in specific rodent species and are endemic in the areas that

are inhabited by rodent species. The viruses that cause chronic infection in these animals are excreted in saliva, urine, and feces over a very long period of time. Humans usually acquire infection from these animals through:

- inhalation of infectious aerosols of dried excreta, especially urine of the rodents that has been passed in the soil.
  - ingestion of food contaminated with rodent feces or urine, or
  - contact of the abraded skin with rodent blood or serum.
- The infections are not usually transmitted by the bite of rodents.

The LCM viruses are distributed in Europe, Australia, Japan, and the Americas. This infection in this area is closely related with presence of infection in common mouse, such as *Mus musculus* and *Mus domesticus*. The mice are the most important reservoir of infection for humans. Hamsters are important reservoirs for pet owners and laboratory workers.

Lassa fever is the disease of West Africa. The outbreaks of Lassa fever have been reported from Nigeria, Sierra Leone, Liberia, and Guinea. The rodents of the genus *Mastomys* are the reservoirs of infection. The infection is transmitted from these infected mice to humans. The infection can also be transmitted from humans to humans.

South American hemorrhagic fever is caused by viruses Junin, Machupo, and Guanarito, which are endemic in Argentina, Bolivia, and Venezuela, respectively. The rodent *Calomys musculinus* is the main reservoir for Argentine hemorrhagic fever. These rodents, which are found commonly in the corn field, transmit the virus to farmers harvesting the corn. The infection is transmitted by inhalation of infectious aerosols. The infection can also be transmitted by ingestion of contaminated food and also by direct contact of blood or tissue from rodents on the abraded finger.

The rodent *Calomys callosus* is the major reservoir for Bolivian hemorrhagic fever, which transmits infection to humans. Transmission of infection occurs through these rodents by inhalation of aerosols from infected organisms and also by ingestion of food contaminated by rodent urine. The cane mouse is the main reservoir for Venezuelan hemorrhagic fever.

## Laboratory Diagnosis

There is a great risk for laboratory workers in handling body fluids for diagnosis. Hence, it is mandatory to process the specimen only in facilities with biosafety level 4 for Lassa fever and other arenaviruses and biosafety level 3 for LCM virus.

### ▶ Specimens

The specimens include blood and CSF.

### ▶ Isolation of the virus

The virus can be isolated easily from blood of the individuals suffering from LCM virus infection and also from the CSF of the individuals developing meningitis. South American hemorrhagic fever viruses can be isolated from blood or tissue using tissue culture or suckling mice. Lassa virus can be

cultured in tissue culture using the E6 clone of Vero cells or in suckling mice.

### ► Serodiagnosis

Serodiagnosis is the most important method for establishing the diagnosis of arenavirus infection in humans.

#### Key Points

- Both ELISA and indirect fluorescent antibody tests are used to demonstrate IgM antibodies in the serum in South American hemorrhagic fever. In this condition, the antibodies appear during the third week of disease.
- Antigen capture ELISA is used to detect antigens in blood and tissues for early diagnosis of South American hemorrhagic fever.
- IgM ELISA is frequently used for detection of antibodies in the serum as well as CSF for the diagnosis of lymphocytic choriomeningitis.

### Treatment

Ribavirin is the antiviral drug used for the treatment of Lassa fever and also for South American hemorrhagic fever. The treatment is mostly supportive to maintain fluid and electrolyte balance, which can be lifesaving.

### Prevention and Control

The prevention of rodent-borne arenavirus infection depends on the rodent control measures and avoidance of high-density rodent-infested areas. No vaccines are available against arenaviruses. Clinical trials of attenuated Junin virus are in progress.

### Coronaviruses

Coronaviruses were so named for the crown-like appearance of their virions on electron microscopy. These viruses are the second most important cause of the common cold; rhinoviruses being the first cause. The coronaviruses have also been reported to cause gastroenteritis in children and adults. Severe acute respiratory syndrome (SARS)-associated coronavirus (SARS-CoV) is a newly described coronavirus in 2002. The virus causes an atypical pneumonia called SARS, a serious and potentially life-threatening viral infection of humans.

SARS-CoV causing atypical pneumonia called severe acute respiratory syndrome or SARS was first reported in 2002 and 2003 outbreak. This outbreak caused by the virus is believed to have originated in Guangdong province, south China. It predominantly affected mainly China, Hong Kong, Singapore, and Taiwan. Subsequently, this outbreak spread to neighboring countries in Asia, Canada, and the United States.

## Properties of the Virus

### ► Morphology

Coronaviruses show following features:

- Coronaviruses are enveloped viruses measuring 80–160 nm in size on electron microscopy.
- The glycoproteins appear as club-shaped projections (20 nm long and 5–11 nm wide) on surface of the envelope.
- The genome in association with N protein forms a helical nucleocapsid.
- The virus contains the glycoproteins E1 and E2 and a core nucleoprotein N. Some strains also contain a glycoprotein E3, which is a hemagglutinin neuraminidase. E1 glycoprotein is a transmembrane matrix protein; E2 glycoprotein mediates viral attachment and membrane fusion.

SARS-CoV is a single-stranded, nonsegmented, plus-sense RNA virus. It measures approximately 30 kb in length. The genomic sequence of SARS-CoV is different from other coronavirus strains. These strains of SARS-CoV are quite stable unlike other coronaviruses in which mutations in the RNA sequence during replication of virus are common. Such mutations contribute to the appearance of new virus to be either more or less virulent. In contrast, the genome sequence of different isolates of SARS-CoV is very similar.

### ► Viral isolation

The attachment of the virus to the cell is mediated by hemagglutinin. The virus enters the cell and uncoats. The replication of the virus occurs in cytoplasm. Synthesis of protein occurs in two stages similar to that of togaviruses. In the first stage, the viral genome is transcribed to produce an RNA-dependent RNA polymerase. Subsequently, the polymerase produces a negative-sense template RNA. This template RNA is utilized by the N protein to produce new viral genomes and individual messenger RNAs (mRNAs) encoding other viral proteins. The assembly of viruses occurs and derives its envelope from the endoplasmic reticulum but not from the plasma membrane.

### ► Antigenic and genomic structure

Coronaviruses have two serotypes, namely, 229E and OC43. SARS virus is relatively stable.

### ► Other properties

The coronaviruses are sensitive to acid, ether, and bile.

### ► Virus isolation

The coronaviruses are difficult to grow in routine cell cultures.

## Pathogenesis and Immunity

The coronaviruses are confined strictly to the mucosal cells of the respiratory tract. These viruses typically cause infections in the upper respiratory tract, because the optimal temperature

for replication of viruses is 37–38°C. The envelope contains (a) E2 viral attachment protein, (b) E1 matrix protein, and (c) N1 nucleocapsid protein. Early phase of the infection produces RNA polymerase (E); late phase produces structural and nonstructural proteins from a negative-sense RNA template.

SARS-CoV causes infection in the respiratory tract by binding to angiotensin-converting enzyme 2 receptors on the surface of respiratory epithelium. This causes alteration in fluid balance and leads to development of edema in alveolar space. Diffuse edema resulting in hypoxia is characteristic of pneumonia caused by SARS-CoV.

Infections caused by coronaviruses produce a short and brief immunity, but reinfection can occur.

## Clinical Syndromes

Coronaviruses cause following syndromes: (a) common cold, (b) gastroenteritis, and (c) SARS.

### Common cold

The coronaviruses (229E and OC43) cause more commonly upper respiratory tract, and less commonly, lower respiratory tract illnesses in humans. Common cold caused by coronaviruses has an incubation period of 3 days. The condition is characterized by rhinorrhea, sore throat, and low-grade fever. The condition typically lasts for several days.

### Gastroenteritis

The coronaviruses have also been reported to cause gastroenteritis in children and adults. The symptoms are mild, and the condition is self-limiting.

### SARS

SARS is a potentially life-threatening infection associated with the onset of flu-like syndrome, which may progress to pneumonia, respiratory failure, and in some cases death. The incubation period varies from 2 to 7 days, although it may be as long as 2 weeks.

Flu-like prodrome is the first stage of the disease, which is characterized by fever ( $>30^{\circ}\text{C}$ ), fatigue, chills, malaise, anorexia, and myalgia. Second stage represents the lower respiratory tract illness that begins three or more days after incubation. Hypoxia, cough, dyspnea, and breathing difficulties are common findings. The cough typically tends to be dry and nonproductive and may range from mild to severe. Fever is typically higher than  $30^{\circ}\text{C}$ . Chest X ray shows interstitial ground glass infiltrates that do not show cavitation. The condition is associated with lymphadenopathy and thrombocytopenia.

Morbidity and mortality due to SARS is more in elderly population and also seen in more individuals with coexisting chronic illness and immunosuppression. The mortality rate of SARS is higher than influenza and other respiratory tract illnesses. The overall mortality is more than 10% and is more than 50% in elderly individuals above 65 years.

## Epidemiology

SARS is restricted in its geographical distribution.

### Geographical distribution

The SARS outbreak in 2002–2003 predominantly affected mainland China, Hong Kong, Singapore, Taiwan, and Canada. The SARS strain is believed to have originated in Guangdong province in southern China. The disease is epidemiologically linked to the National Institute of Virology in Beijing, where the outbreak is thought to have originated. A total of 8098 cases, 774 deaths, and 7324 recoveries from SARS were documented between November 2002 and April 21, 2004.

### Reservoir, source, and transmission of infection

SARS is believed to be primarily transmitted by close person-to-person contact. Most cases of SARS were seen in individuals who lived with or cared for a patient with SARS or who had exposure to contaminated secretions from a SARS patient.

The infection would possibly have been acquired by inhalation of infectious droplets during the act of coughing or sneezing, from a SARS patient. Moreover, another possible mode of transmission is direct contact of the eyes, nose, or mouth of susceptible individuals with infectious secretions of SARS patients.

## Key Points

- It is suggested that SARS-CoV may have originated in chickens, ducks, or small mammals. In these animals, the virus would have mutated, subsequently being transmitted, thereby causing infection in humans. The transmission to humans is facilitated possibly by the proximity in which humans and livestock live in rural southern China. The avian flu epidemic in Hong Kong in 1977, which originated in poultry and spread to humans (resulting in the slaughter of millions of chickens), is a classical example of this type of zoonotic transmission.
- It is also postulated that the SARS-CoV initially originated in civet cats, which were sold in a Guangdong marketplace in rural southern China as a food delicacy. Close contact with their saliva or feces, or with the animals themselves, possibly has transmitted a mutated SARS-CoV to humans.

## Laboratory Diagnosis

Laboratory diagnostic tests are most essential to confirm diagnosis of the SARS.

### Specimens

Specimens include respiratory secretions for isolation of virus, and serum for testing of antibodies.

### ► Isolation of the virus

SARS-CoV can be isolated in viral cultures. Isolation of virus is attempted only in class III laboratories.

### ► Serodiagnosis

Serodiagnosis of SARS depends on detection of specific antibodies to SARS-CoV in serum obtained during acute illness or 28 days and more after the onset of disease. IFA and ELISAs are the most frequently used tests for detection of specific antibodies in patients with SARS. Demonstration of a four-fold rise of antibody titer between acute and convalescent (>28 days after symptom onset) serum samples is suggestive of SARS.



### Molecular Diagnosis

Reverse transcriptase-polymerase chain reaction (RT-PCR) is employed for detection of SARS-CoV RNA in serum, stool, and nasal secretions. The test is positive in some patients within the first 10 days of fever.

### Treatment

No specific antiviral treatment is available against SARS. Treatment is mostly symptomatic as given for a serious community-acquired pneumonia.

### Prevention and Control

Isolation of patient and strict barrier nursing is crucial to prevent transmission of SARS to others. Moreover, airport screening for potentially sick and/or febrile passengers is being carried out in SARS-affected regions in Asia by using infrared scanners. These scanners identify potentially febrile passengers by measuring their body heat. The software in the scanner is color-coded in temperature ranges; as skin temperature increases, the colors on the scanner change, such as black to green to yellow and, finally, to red. Any individual with a skin temperature of 37.5°C or greater glows bright red on the scanner. This, however, shows a lot of false-positive reactions, as many other noninfectious conditions (sunburn, ingestion of alcoholic beverages, recent cigarette smoking, or brisk exercise, etc.) can cause an increase in the skin temperature.



### CASE STUDY

A group of medical college students went for dining in a hotel on the last day of their final university examination. After 2 days of dining in the hotel, all of them complained of mild fever, nausea, vomiting, and watery diarrhea. The symptoms lasted only for 24 hours. The symptoms were not suggestive of bacterial gastroenteritis or food poisoning.

- What is the most likely viral etiology of the condition?
- How is this viral agent transmitted?
- What are the laboratory tests used for establishing the diagnosis of the condition?
- How can you prevent the condition?

"This page intentionally left blank"

"This page intentionally left blank"



# Introduction to Mycology

## Introduction

Mycology is the study of fungi. The name “fungi” is derived from “mykos” meaning mushroom. The fungi are eukaryotic organisms and they differ from the bacteria, which are prokaryotic organisms, in many ways (Table 71-1). The fungi possess rigid cell walls, which possess two characteristic cell structures: chitin and ergosterol.

**Chitin:** The fungi consist primarily of chitin, unlike peptidoglycan present in cell wall of bacteria. Hence, fungi are not sensitive to action of penicillin and other antibiotics that inhibit peptidoglycan synthesis. Chitin is a polysaccharide consisting of long chains of *N*-acetylglucosamine. In addition to chitin, the fungal cell wall also contains mannan and other polysaccharides. Of these, beta-glucan is most important, because it is the target of antifungal drug caspofungin.

**Ergosterol:** The cell membrane of fungus contains ergosterol, unlike human cell membrane which contains cholesterol. The antifungal agents, such as amphotericin B, fluconazole, and ketoconazole have selective action on the fungi due to this basic difference in membrane sterols.

## Classification of Fungi

The fungi can be classified as follows:

### Taxonomical Classification

The fungi are placed in the phylum Thallophyta. There are four classes of fungi: Zygomycetes, Ascomycetes, Basidiomycetes, and Deuteromycetes or Fungi Imperfecti.

TABLE 71-1

Comparison of fungi and bacteria

Feature	Fungi	Bacteria
Diameter	Approximately 4 $\mu\text{m}$	Approximately 1 $\mu\text{m}$
Morphology	Yeast and mold	Cocci, bacilli, spirochete, branching filamentous
Staining property	Gram-positive, nonacid fast, stained with PAS and GMS	Gram-positive, Gram-negative, acid fast
Cell wall content	Chitin	Peptidoglycan
Cell membrane	Sterols present	Sterols absent except mycoplasma
Cytoplasm	Mitochondria and endoplasmic reticulum present	Mitochondria and endoplasmic reticulum absent
Nucleus	Eukaryotic	Prokaryotic
Spores	Sexual and asexual spores for reproduction	Endospores for survival, not for reproduction
Thermal dimorphism	Yes (seen in some fungi)	No

PAS, periodic acid-Schiff; GMS, Gomori's methenamine silver.

## Morphological Classification

The fungi can be classified into the following four main groups based upon the morphology: (a) yeast, (b) yeast-like form, (c) molds, and (d) dimorphic fungi.

### Key Points

**Yeast:** Yeasts are round or oval unicellular fungi that reproduce by asexual budding. On culture medium, such as Sabouraud's dextrose agar (SDA), they produce creamy mucoid colonies. Example: *Cryptococcus neoformans*.

**Yeast-like fungi:** These are the yeasts with pseudohyphae. Example: *Candida albicans*.

**Molds:** Molds grow as long filaments called *hyphae*. They usually measure 2–10  $\mu\text{m}$  in width. Some hyphae form transverse walls and hence they are called septate hyphae, whereas others do not produce walls, hence are called nonseptate hyphae. Nonseptate hyphae are multinucleated. The hyphae on their continuous growth form a mat known as *mycelium*. The part of the mycelium that projects above the surface in culture medium is called aerial mycelium. Examples include *Aspergillus*, *Penicillium*, *Rhizopus*, etc.

**Dimorphic fungi:** Many of medically important fungi are dimorphic. They exist as hyphal/mycelial forms in the soil and in the cultures at 22–25°C. They occur as yeasts or other structures in human tissue and in the culture at 37°C (Fig. 71-1). Examples include *Coccidioides immitis*, *Paracoccidioides brasiliensis*, *Histoplasma capsulatum*, *Blastomyces dermatitidis*, and *Sporothrix schenckii*.

## Reproduction of Fungi

Fungi can reproduce sexually by forming sexual spores and asexually by forming conidia or asexual spores. **Sexual spores**

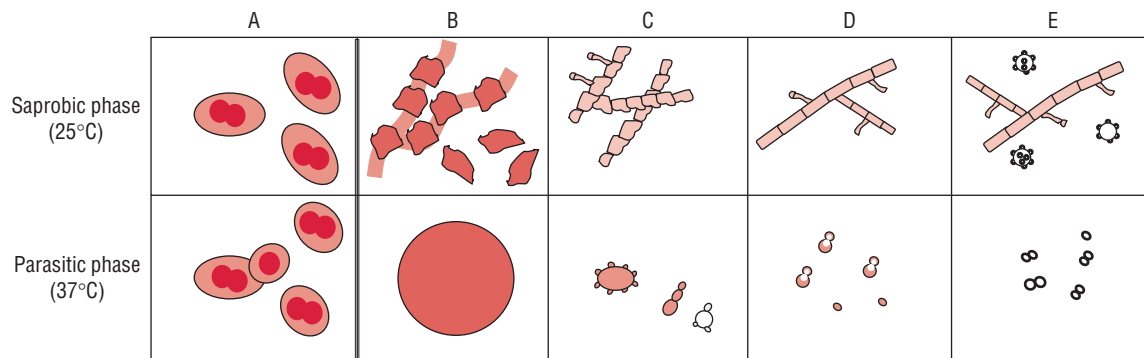

FIG. 71-1. Dimorphic fungi.

are of three types: zygospores, ascospores, and basidiospores (Fig. 71-2). Ascospores are formed in a sac called *ascus*, whereas basidiospores are formed outside on the tip of a pedestal called a *basidium*. Zygospores are single, large spores with thick wall. The fungi that do not produce sexual spores are called imperfect and are classified as *Fungi imperfecti*. **Asexual spores** are produced by mitosis. Fungi reproduce asexually by forming conidia. The shape, color, and arrangement of the conidia are helpful for identification of the fungi. Asexual spores can be vegetative or aerial spores as follows:

**A. Vegetative spores:** These include (a) arthrospores, (b) chlamydospores, and (c) blastospores.

- *Arthrospores* are formed by fragmentations of the ends of hyphae, resulting in rectangular thick-walled spores. The arthrospores are the infective stage of *C. immitis*.
- *Chlamydospores* arise by rounding and thickening of hyphal segments. They are round and thick walled. The terminal chlamydospores help in the identification of *C. albicans*.
- *Blastospores* are formed by budding process from parent cells, such as yeast. Some yeasts, such as *C. albicans* can form multiple buds that do not detach from the parent yeast, thus producing elongated structures called *pseudohyphae*.

**B. Aerial spores:** These include (a) sporangiospores, (b) conidiospores, (c) microconidia, and (d) macroconidia.

- *Sporangiospores* are spores formed within a sac called sporangium, which develops at the ends of the hyphae called sporangiophores (e.g., *Mucor* and *Rhizopus*).
- *Conidiospores*, or otherwise called conidia, are spores found externally on the sides or tips of hyphae. Conidia can be macroconidia or microconidia.
- *Macroconidia* are large, aseptate, often multicellular conidia.
- *Microconidia* are small and single.

## Pathogenesis of Fungal Infection

Most fungi are obligate aerobes or facultative anaerobes, but none are obligate anaerobes. The natural habitat of most fungi is environment, because all these fungi require a preformed organic source of carbon, hence their constant association with decaying matter. *C. albicans* is exception and is an important fungus, which is a part of the normal human flora.

Fungi are ubiquitous in nature, i.e., they occur as free-living saprobes, hence determining their role in human infection may sometimes be difficult. The effects of fungi on humans can be grouped in three major ways as follows: (a) colonization and disease, (b) hypersensitive diseases, and (c) diseases caused by mycotoxins or fungal toxins.

## Colonization and Disease

Most fungal infections are mild and self-limited. Intact skin is an effective host defense against certain fungi. But if the skin is broken, organisms, the fungi enter through that broken skin and initiate the infection. Fatty acid content, pH, epithelial turnover, and normal bacterial flora of the skin contribute to host resistance against fungi. For example, the mucous membrane of the nasopharynx traps inhaled fungal spores.

Cell-mediated immunity is much important in conferring protection against fungi. Suppression of cell-mediated immunity can lead to reactivation and dissemination of asymptomatic fungal infection and to diseases caused by opportunistic fungi. The humoral immunity is mediated by production of IgG and IgM antibody. But their role in protection from fungal disease is uncertain.

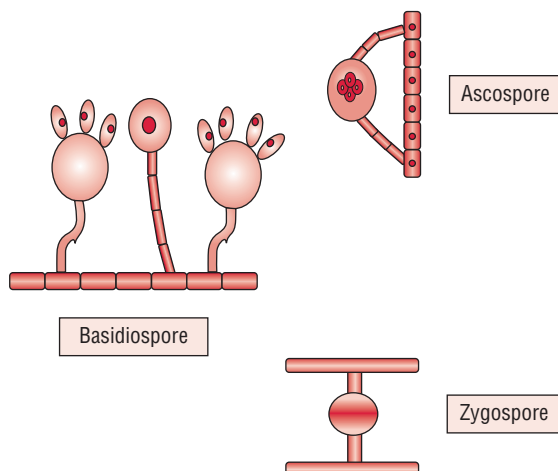

FIG. 71-2. Sexual spores.

Fungal infection that occurs in the immunocompromised hosts is called as opportunistic mycosis. If such conditions are not rapidly diagnosed and immediately managed, they can prove to be life-threatening.

## Hypersensitivity Diseases

Humans are continually exposed to air-borne fungal spores and other fungal elements present in the environment. These spores can be antigenic stimulants and depending on individual's immunological status may induce a state of hypersensitivity by production of immunoglobulins or sensitized lymphocytes. Rhinitis, bronchial asthma, alveolitis, and various forms of atopy are the clinical manifestations of hypersensitive pneumonitis. The clinical manifestations of the hypersensitivity disease are seen only in sensitized person, after repeated exposure to the fungus, fungal metabolites, or other cross-reactive materials.

Allergies to the fungal spores are manifested primarily by an asthmatic reaction including rapid bronchial constriction mediated by IgE, eosinophilia, and positive hypersensitivity skin test reaction. These are caused due to immediate hypersensitivity reactions of the host to fungal spores.

## Diseases Caused by Fungal Toxins

Mycotoxicosis is caused by ingested fungal toxins. Mycotoxicosis caused by eating amanita mushroom is the best example of mycotoxicosis. This group of fungi produces five toxins. Of these, amanitine and phalloidin are the two most potent hepatotoxins. The toxicity of amanitine is due to its ability to inhibit cellular RNA polymerase, which prevents mRNA synthesis.

Aflatoxin is another fungal toxin produced by *Aspergillus flavus* that causes disease in humans. Aflatoxin-B causes a mutation in the P53 tumor-suppressor gene, resulting in a loss of P53 protein, thereby in a resultant loss of growth control in the hepatocytes. Hence, it causes damage to liver, and it induces tumor in liver in animals and is associated with hepatic carcinomas in humans.

*Claviceps purpurea* is a mold that infects brain and produces alkaloids, such as ergotamine and lysergic acid diethyl amide. These compounds cause serious vascular and neurological effects.

Yellow rice toxicosis in Japan and elementary toxic aleukia in the former Soviet Union are the examples of other mycotoxicoses.

The transmission and habitat of some important fungi in India are described in Table 71-2.

TABLE 71-2

Transmission and habitat of some important fungi in India

Fungi	Habitat	Form transmitted	Portal of entry
<i>Cryptococcus</i>	Soil (pigeon feces)	Yeast	Inhalation into lungs
<i>Aspergillus</i>	Soil and vegetation	Conidia	Inhalation into lungs
<i>Candida</i>	Human body	Yeast	Normal flora of skin, mucosa, gastrointestinal tract, and vagina
<i>Rhinosporidium seeberi</i>	Fresh or stagnant water	Sporangia	Penetration of mucous membrane
<i>Penicilliosis marneffeii</i>	Soil	Conidia	Inhalation of conidia

## Laboratory Diagnosis

Laboratory diagnosis of fungal infections depends on: (a) direct microscopy, (b) culture, (c) serological tests, (d) non-culture methods, and (e) molecular methods.

### Direct Microscopy

Direct microscopic examination depends on demonstration of characteristic asexual spores, hyphae, or yeast in various clinical specimens by light microscopy. The commonly used clinical specimens are sputum, lung biopsy material, and skin scrapings.

The specimen is either treated with 10% KOH or stained with special fungal stains. Use of 10% KOH dissolves tissue material, leaving the alkali-resistant fungi intact.

Calcofluor dye is a fluorescent dye that combines with fungal cell wall and is useful in identification of fungi in tissue specimens. Methenamine silver stain is useful for demonstration of fungi in tissues. India ink preparation of cerebrospinal fluid (CSF) is a useful method for demonstration of white capsule of *C. neoformans* in CSF. Gram staining is also useful to demonstrate Gram-positive *Candida* species in the specimen.

The disadvantages of microscopy are that it shows low sensitivity and requires an experienced microscopist for specific identification.

### Culture

Fungal culture is a frequently used method for confirming the diagnosis of fungal infection. SDA is the most commonly used medium for fungal culture. Other media include CHROM agar, blood agar, etc. The low pH of the medium and addition of chloramphenicol and cycloheximide to the medium inhibit the growth of bacteria in the specimen and thereby facilitate the appearance of slow-growing fungi.

Fungal colony is identified by rapidity of growth, color, and morphology of the colony at the obverse and pigmentation at the reverse.

Microscopy of the fungal colony is carried out in lactophenol cotton blue (LPCB) mount to study the morphology of hyphae, spores, and other structures. The appearance of the mycelium and the nature of the asexual spores are very much helpful to identify the fungus.

Culture, however, is time-consuming in most cases and also the yield is not very good. Culture following lysis of the

specimens, such as blood, obviates this problem. Blood lysed by addition of certain substances, followed by centrifugation, increases yield of fungi by culture. Yield can be further increased with a shortening of time by combining with BACTEC systems.

## Serological Tests

Demonstration of the antibodies in patient's serum or CSF is useful for diagnosis of fungal infections, especially in systemic fungal infections. A significant rise of antibody titer in a paired sera sample confirms the diagnosis. The complement fixation test was the earliest test used in fungal serology and is still used in the diagnosis of suspected cases of histoplasmosis, blastomycosis, or coccidiomycosis. Recently, newer tests like ELISA (enzyme-linked immunosorbent assay), Western blot, and radioimmunoassays are increasingly used for serodiagnosis of fungal infections.

## Nonculture Methods

These methods include (a) detection of fungal antigen, (b) detection of fungal cell wall markers, and (c) detection of fungal metabolites.

**Antigen detection:** It is useful in immunocompromised hosts where antibody detection is not as sensitive. Detection of fungal antigen in serum, CSF, and urine is increasingly used for diagnosis of many fungal infections. Demonstration of antigen indicates recent or active infection. Latex agglutination test is a frequently used test to demonstrate polysaccharide capsular antigen of *C. neoformans* in CSF for diagnosis of cryptococcal meningitis. False-positive reactions due to *Trichosporon beigelli* and *Capnocytophaga canimorsus* are known.

**Detection of fungal cell wall markers:** Mannan is a highly immunogenic component of the candidal cell wall. Mannan antigen detection, therefore, is most widely used method in the diagnosis of candidiasis.

Galactomannan is a heat-stable heteropolysaccharide found in the cell walls of all *Aspergillus* species. Production of the galactomannan antigen is proportional to fungal load in tissue, hence is being used as the prognostic marker for diagnosis of invasive aspergillosis. A sandwich ELISA using rat monoclonal antibody EB-A2 against galactomannan antigen is being currently used in Europe for diagnosis of invasive aspergillosis.

Most pathogenic fungi have 1, 3-beta-D-glucan in their cell walls and minute quantities are secreted into the circulation during the life cycle. Detection of this antigen can also be used as an indicator of invasive fungal infections. Detection of 1, 3-beta-D-glucan is based on its ability to activate a coagulation cascade within amebocytes derived from the hemolymph of horseshoe crabs. This uses a different cascade than endotoxin to cause coagulation, hence is specific for fungi. The test does not detect certain species, such as *C. neoformans* and Zygomycetes.

**Detection of fungal metabolites:** Detection of distinctive fungal metabolites is another approach for the diagnosis of fungal infections. Gas liquid chromatography is being used to quantify arabinitol for diagnosis of *C. albicans* infections.



## Molecular Diagnosis

DNA probes are the recent techniques, which are very useful to identify colonies growing in culture at an earlier stage of growth. These DNA probes are very useful for rapid diagnosis of these cultures in comparison to traditional methods of visual detection of colonies. DNA probes are now available for detection of *Cryptococcus*, *Histoplasma*, *Blastomyces*, and *Coccidioides*. Mitochondrial DNA has been used for the diagnosis of *C. albicans* and *Aspergillus* species.

## Antifungal Drugs

A few drugs are available for therapy of systemic fungal infection, unlike a large number of antibiotics available to treat bacterial infections. The drugs used to treat bacterial disease have no effect on fungal diseases. Amphotericin B and various azoles are the most effective antifungal drugs. They act on the ergosterol of fungal cell membrane that is not found in bacterial or human cell membrane. Similarly, caspofungin inhibits synthesis of beta-glucan, which is found only in fungal membrane but not in bacterial or human cell membrane. Table 71-3 summarizes the common antifungal agents and their primary sites of activity.

TABLE 71-3

### Antifungal agents and primary sites of activity

Group of compounds	Antifungal agent	Mechanism of action
<b>Polyenes</b>	Amphotericin B Nystatin	Bind to ergosterol
<b>Azole derivatives</b>	Miconazole Ketoconazole Fluconazole Itraconazole	Inhibit cytochrome P-450 dependent enzymes
<b>Nucleoside analogs</b>	5-fluoro-cytosine	Inhibits DNA and RNA synthesis
<b>Grisans</b>	Griseofulvin	Inhibits microtubular function
<b>Allylamines</b>	Naftifine Terbinafine	Squalene epoxidase inhibitors
<b>Thiocarbamates</b>	Tolnaftate Tolciclate	Squalene epoxidase inhibitors
<b>Morpholines</b>	Amorolfine	Inhibits ergosterol biosynthesis
<b>Echinocandins</b>	Caspofungin, Anidulafungin	B-1, 3 glucan synthetase inhibitors

# Superficial, Cutaneous, and Subcutaneous Mycoses

# 72

## Introduction

Fungal infections, depending on the tissues that are initially colonized, can be classified into three major groups as follows:

**Superficial mycoses:** These are surface infections of the skin, affecting the outermost layers of skin, hair, and mucosa.

**Cutaneous mycoses:** These are infections of the skin involving the epidermis and its integuments, the hair, and nails.

**Subcutaneous mycoses:** These are infections of the dermis, subcutaneous tissue, muscle, and fascia.

## Superficial Mycoses

Superficial mycosis caused by different fungi is restricted to the outermost layers of the skin and hair. The condition usually causes cosmetic problem, which can be easily diagnosed and treated. It includes four important conditions: (a) pityriasis versicolor, (b) tinea nigra, (c) black piedra, and (d) white piedra.

### Pityriasis Versicolor

Pityriasis versicolor or tinea versicolor is a superficial infection of the skin caused by *Malassezia furfur* (*Pityrosporum orbiculare*). *M. furfur* requires fatty acids for growth, hence is cultured on the Sabouraud's dextrose agar (SDA) overlaid with a layer of olive oil. On incubation at 37°C, the fungus produces creamy colonies within 5–7 days. The lactophenol cotton blue (LPCB) wet mount of these colonies shows budding yeast cell along with a number of bottle-shaped cells. The fungus is found in parts of the body rich in sebaceous glands. The lesions of pityriasis versicolor are found most commonly on the upper tissue, arms, and abdomen. They appear as hypopigmented macular lesions often associated with slight scaling or itching. The condition is mostly asymptomatic. It occurs most frequently in hot and humid weather.

Laboratory diagnosis of the condition is usually made by demonstration of both budding yeast cell and hyphae in KOH preparation of skin scrapings. Characteristic “spaghetti and meatballs” appearance of fungus is demonstrated in the microscopy of KOH preparation of the skin. Culture is not carried out routinely for diagnosis. Topical miconazole is treatment of choice.

### Tinea Nigra

Tinea nigra is an infection of keratinized layer of skin caused by *Exophiala werneckii* or *Cladosporium werneckii*. *C. werneckii* is a dimorphic fungus that produces melanin. The fungus on the SDA grows as yeast with many cells in various stages of cell division producing typical two-celled oval structure, on primary isolation from clinical specimen. On prolonged incubation, elongated hyphae develop and in older cultures, mycelia and conidia are predominantly found.

A well-demarcated brown-black macular lesion, which appears as brownish spot of the skin, is typical manifestation of the condition. These brownish to black lesions are most commonly seen on palms and soles.

Laboratory diagnosis of tinea nigra is made by microscopy of the KOH preparation of skin scrapings collected from the affected part. Typical darkly pigmented yeast-like cells and hyperfragmented hyphae are demonstrated. Culture of the skin scraping on the SDA confirms the diagnosis.

### Black Piedra

Black piedra is a superficial infection of the hair caused by *Piedraia hortae*, a dematiaceous fungus. The fungus occurs in the perfect state when it colonizes the shaft of hairs. Culture of specimens on SDA shows slow-growing brown to reddish black mycelium, which is considered asexual or anamorphic stage of the fungus. The teleomorphic state, which is the perfect state of the fungus, is occasionally found in old cultures. At this state asci, which contain spindle-shaped ascospores, develop within specialized structures.

Infection of shaft of hairs of beard and scalp is the major clinical feature of black piedra. Laboratory diagnosis of the condition is made by demonstration of nodules containing asci with spindle-shaped ascospores in 10% KOH mount of the hair.

### White Piedra

White piedra is an infection of the hair caused by yeast-like organism *Trichosporon beigelli*. The fungus can be grown on SDA and other media containing cycloheximide. On SDA, it forms green-colored colonies, which subsequently become yellowish gray and wrinkled. Microscopic examination of the colony shows septate hyphae that break rapidly to form arthroconidia. The latter subsequently become round and develop to blastoconidia.

TABLE 72-1

## Features of the organisms causing superficial mycoses

Disease	Organism	Tissue	Diagnosis
Pityriasis versicolor	<i>Malassezia furfur</i>	Skin	Microscopy of skin scraping with 10% KOH shows “spaghetti and meatballs” appearance
Tinea nigra	<i>Exophiala werneckii</i>	Skin	Culture on SDA yields black yeast and hyphae
Black piedra	<i>Piedraia hortae</i>	Hair	Direct microscopy; culture yields asexual phase
White piedra	<i>Trichosporon beigelli</i>	Hair	Direct microscopy; culture on SDA; hyphae, arthroconidia, and blastoconidia

White piedra is commonly found in South America, Central and Eastern Europe, and Japan.

The hair of scalp, moustache, and beard are commonly affected in white piedra. The development of a soft, pasty, cream-colored growth along infected hair shaft characterizes the condition. The initial growth of *T. beigelli* occurs beneath the epidermis of hair. The infected hair shaft consists of mycelium that rapidly fragments to arthroconidia.

Laboratory diagnosis of the condition is made by demonstration of fragmented hyphae that develop into arthroconidia or produce blastoconidia in 10% KOH mount of hair. Culture of the fungus from clinical specimen confirms the diagnosis. Features of the organisms causing superficial mycoses are summarized in Table 72-1.

## Cutaneous Mycoses

Dermatophytoses or cutaneous mycoses are diseases of the skin, hair, and nail. These infections are caused by a homogeneous group of closely related fungi known as dermatophytes. These dermatophytes infect only superficial keratinized structures, such as skin, hair, and nail, but not deeper tissues.

## Dermatophytes

The most important dermatophytes that cause infection in humans are classified into the following three genera:

- (i) *Trichophyton*—causes infection of hair, skin, and nail.
- (ii) *Microsporum*—causes infection of hair and skin.
- (iii) *Epidermophyton*—causes infection of skin and nails, but not hair (Fig. 72-1).

The dermatophytes on the basis of their natural habitat and host preferences can be classified into following groups:

- (i) **Anthropophilic species:** These dermatophytes are typically adapted to live on human host. They are transmitted from human to human through fallen hairs, desquamated epithelium, combs, hair brushes, towels, etc. Examples are *Trichophyton rubrum*, *Microsporum audouinii*, and *Epidermophyton floccosum*.
- (ii) **Zoophilic species:** These are the dermatophytes that live on animals and often cause infection in their animal host. These zoophilic species are transmitted from infected animals to humans by direct and indirect contacts with domestic animals (e.g., cat and dog) and occasionally wild animals. Examples are *Trichophyton violaceum* and *Microsporum canis*.

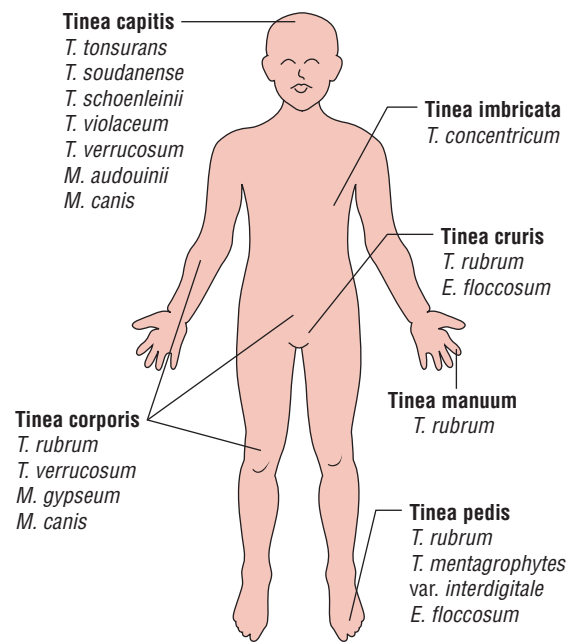

FIG. 72-1. Infections caused by different dermatophytes.

- (iii) **Geophilic species:** These are saprophytic fungi found in soil or in dead organic substances. They occasionally cause infection in humans and animals. Examples are *Microsporum gypseum* and *Trichophyton ajelloi*. Dermatophytes usually grow only on keratinized skin and its appendages, and do not penetrate the living tissues. In some infected persons, hypersensitivity to fungus antigen may cause secondary eruptions, such as vesicles on the finger. This reaction is known as dermatophytid (*id*) reaction. This reaction occurs as a result of hypersensitivity response to circulating fungal antigen, and these lesions do not contain any fungal hyphae.

Asexual state of selected dermatophytes is mentioned in Table 72-2.

## Clinical syndromes

The skin infections caused by dermatophytes are chronic infections of the skin often found in the warm humid areas of the body, such as athlete's foot and jock itch. Typical ringworm lesions are circular, which have an inflamed border containing papules and vesicles surrounding a clear area of relatively normal skin. These lesions are associated with variable degrees of scaling and inflammation. Broken hair and thickened broken nails are often seen in this lesion.

Clinically, ringworm can be classified depending on the site affected. These are (a) *Tinea capitis* involving scalp, (b) *Tinea corporis* involving nonhairy skin of the body, (c) *Tinea cruris* affecting groin, (d) *Tinea pedis* affecting foot, and (e) *Tinea barbae* affecting beard areas of face and neck.

*Favus* is a chronic ringworm infection affecting hair follicle. It leads to alopecia and scarring.

**Laboratory diagnosis**

Laboratory diagnosis is based on demonstration of fungal element in clinical specimen by microscopy and confirmation by culture. The specimens include skin scrapings and nail clippings or hair taken from the areas suspected to be infected by dermatophytes. These entire specimens are treated with alkali solution to clear epithelial cells and other debris. Direct microscopy is useful only for diagnosis, while culture is always carried out to identify the specific causative fungal agent.

**Direct microscopy**

Examination of 10% direct KOH mount may show fungal hyphae. Three types of hair infections can be demonstrated in microscopy of 10% KOH wet mount as follows (Fig. 72-2):

**Ectothrix:** Ectothrix infection is characterized by presence of a layer of arthrospores on the surface of hair shaft (Color Photo 60). It is caused by *M. audouinii*, *M. canis*, and *Trichophyton mentagrophytes*.

**TABLE 72-2 Asexual state of selected dermatophytes**

<i>Microsporum</i>	<i>Trichophyton</i>	<i>Epidermophyton</i>
<i>Microsporum audouinii</i>	<i>Trichophyton mentagrophytes</i>	<i>Epidermophyton floccosum</i>
<i>Microsporum canis</i>	<i>Trichophyton rubrum</i>	<i>Epidermophyton stockdaleae</i>
<i>Microsporum gypseum</i>	<i>Trichophyton tonsurans</i>	
<i>Microsporum gallinae</i>	<i>Trichophyton verrucosum</i>	
	<i>Trichophyton schoenleinii</i>	

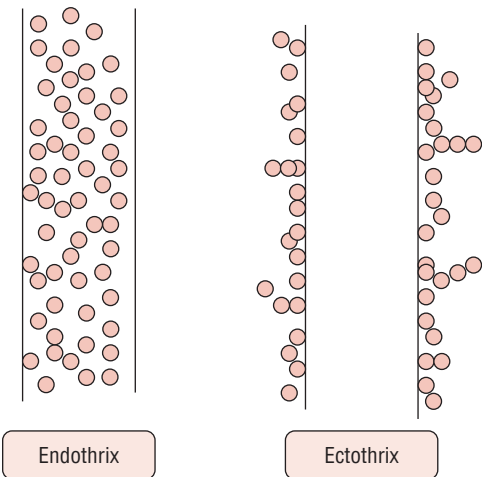

**FIG. 72-2.** Ectothrix and endothrix infections.

**Endothrix:** The clusters of arthrospores are found entirely within the hair shaft in endothrix infection (Color Photo 61). It is caused by *Trichophyton tonsurans*, *T. violaceum*, and *Trichophyton schoenleinii*.

**Favus:** In favus, there is sparse hyphal growth and formation of air spaces within hair shaft. It is caused by *T. violaceum*, *T. schoenleinii*, and *M. gypseum*.

**Culture**

The clinical specimens are cultured by inoculation on SDA containing antibiotics like cycloheximide. The media after inoculation are incubated at 25–30°C for 3 weeks. At 25°C most of the pathogenic fungi grow well, while saprophytic fungi and bacteria are inhibited.

The cultures are examined at regular intervals, and dermatophytes are identified based on (a) colony morphology, (b) pigment production, and (c) presence of microconidia and macroconidia. The LPCB preparation of the colonies shows microconidia, macroconidia, or both. Only macroconidia are present in the *Epidermophyton* infection. Few macroconidia and more microconidia are present in *Trichophyton* infection. Macroconidia are predominantly present in *Microsporum* infection. The differentiation of three genera is based mainly on the nature of macroconidia (Table 72-3; Fig. 72-3).

**Key Points**

**Trichophyton:** Colonies are powdery, velvety, or waxy with pigment characteristic of different species. Microconidia are abundant but macroconidia are very few. The microconidia are arranged in clusters along with hyphae and are present on tip of conidiophores. Some species may have special type of hyphae, such as spiral hyphae or racket hyphae, etc. *Trichophyton* species infect hairs, skin, and nails.

**Microsporum:** Infects both skin and hair, but not the nails. They produce cottony, velvety, or powdery colonies with white-brown pigment. Microconidia are relatively scanty but macroconidia are abundant.

**Epidermophyton:** Infects skin and nails but not hair. It produces powdery and greenish yellow colonies. Macroconidia are numerous. The macroconidia are club-shaped, multiseptate, and are arranged in groups of two to three. Chlamydoconidia are numerous but microconidia are absent.

**Other tests**

**Hair perforation test:** This test is performed to differentiate *T. rubrum* from *T. mentagrophytes*. The test is also used to differentiate *M. canis* from *Microsporum equinus*. This test is performed by collecting 5–10 mm short shaft of human hair and placing it in a Petri dish with 20 mL of distilled water. Then, two to three drops of 10% sterile yeast extract is added to the Petri

**TABLE 72-3 General characteristics of macroconidia and microconidia of dermatophytes**

	<i>Microsporum</i>	<i>Epidermophyton</i>	<i>Trichophyton</i>
<b>Macroconidia</b>	Thick-walled, rough, numerous	Smooth-walled, numerous	Thin-walled, smooth, rare
<b>Microconidia</b>	Rare	Absent	Abundant

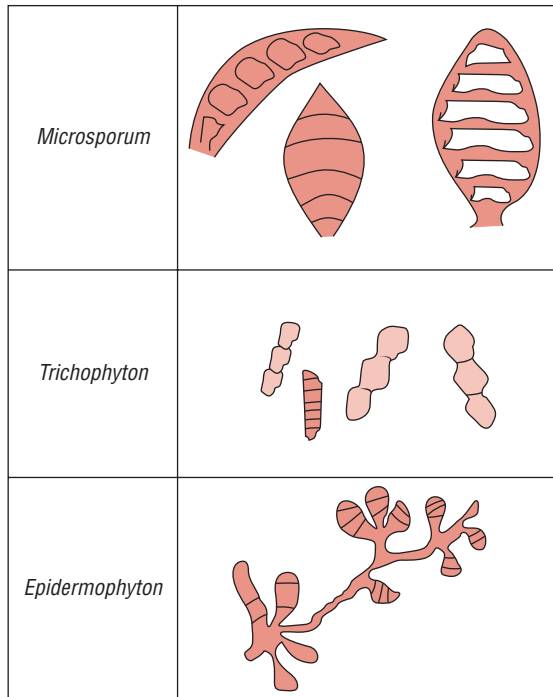

**FIG. 72-3.** Macroconidia in genera *Trichophyton*, *Microsporium*, and *Epidermophyton*.

dish with hair shafts. These hair shafts are inoculated with test fungus cultured on SDA. The culture is incubated at 25°C for up to 1 month, during which the hairs are removed and LPCB mount of the hair is examined microscopically at weekly intervals for the demonstration of the perforation of hair.

*T. mentagrophytes* (Color Photo 62) shows a positive hair perforation test characterized by a wedge-shaped perforation of the hair. This test is negative for *T. rubrum* in which only surface eruption of hair shaft is demonstrated.

**Urease test:** Urease test is carried out to differentiate *T. mentagrophytes* from *T. rubrum*. This test is performed by inoculating a tube of Christensen's medium with the fungus and incubating at 25°C for 5 days at room temperature. Most *T. mentagrophytes* are urease positive within 5 days.

**Growth on rice grains:** This test is useful to differentiate *M. canis* from *M. audouinii*. In this test, sterile, nonfortified rice is inoculated with the hyphae of the fungi to be tested. The medium is observed for growth after 10 days of incubation at room temperature. *M. canis* usually grows well and forms many conidia on rice grain, whereas *M. audouinii* fails to grow.

## ► Treatment

Treatment of dermatophyte infection is carried out by use of local antifungal drugs, such as miconazole, clotrimazole, econazole, etc., or by treatment orally with griseofulvin.

## Subcutaneous Mycosis

Subcutaneous mycosis is defined as fungal infection associated with development of characteristic lesion in subcutaneous

tissue and overlying skin with or without extension to bone and muscle. This is caused by a heterogeneous group of fungal infection of low pathogenic potential introduced in the body percutaneously from a trivial trauma. Table 72-4 shows the classification of subcutaneous mycoses.

## Mycetoma

Mycetoma is a slowly progressive, chronic granulomatous infection of skin and subcutaneous tissues with occasional involvement of underlying fascia and bone usually affecting extremities. The condition is characterized by a triad of (a) tumefaction, (b) draining sinuses, and (c) grains or granules.

The condition was described as early as in *Atharva-Veda: padmavalmikam* means anthill foot. John Gill first described the condition in Madurai (India) in 1842. Colebrook confirmed it in 1846. Henry Vandyke Carter, a professor at Grants Medical College, Mumbai, coined the term *mycetoma* in 1874. Chalmer and Christopherson coined the term *maduramycosis* in 1916.

Mycetoma is caused by a number of actinomycetes and filamentous fungi that enter through penetrating injuries resulting from thorn pricks, splinters, etc (Table 72-5). Lower extremities are most commonly involved. Microabscesses are formed in subcutaneous tissues surrounded by polymorphonuclear inflammatory reaction. The center of the lesion consists of tangled filaments of these organisms.

During the course of infection, microabscesses burst open with the formation of chronic multiple sinuses discharging copious, seropurulent fluid containing granules. The color and consistency of these granules vary depending on the fungi that cause the disease (Table 72-5). The condition is characterized by formation of painless, localized, swollen lesions on the affected limbs. Multiple discharging sinuses are present. Discharge is purulent, mucopurulent, or serosanguinous and usually contains granules of varying size, color, and consistency. Fascia and bone may be affected but underlying tendons and nerves are never affected.

The condition during period of time spreads slowly, but over years by contiguity. Sometimes the infection becomes extensive by involving buttock and trunk. Actinomycetes spread faster than eumycetes. Hematogenous spread is rare.

**TABLE 72-4**

### Causative agents of subcutaneous mycoses

Condition	Causative agents
Mycetoma	Bacteria, fungi
Chromoblastomycosis	<i>Fonsecaea pedrosoi</i> <i>Fonsecaea compactum</i> <i>Phialophora verrucosa</i> <i>Cladophialophora carrionii</i> <i>Rhinocladiella aquaspersa</i>
Phaeohyphomycosis	<i>Exophiala jeanselmei</i> <i>Bipolaris spicifera</i> <i>Wangiella dermatitidis</i>
Sporotrichosis	<i>Sporothrix schenckii</i>
Rhinosporeidiosis	<i>Rhinosporeidium seeberi</i>



TABLE 72-5

## Important causative agents of mycetoma

Grain	Causative agents
Black grain	<i>Madurella mycetomatis</i> <i>Madurella grisea</i> <i>Exophiala jeanselmei</i> <i>Curvularia geniculata</i>
White grain	<i>Pseudoallescheria boydii</i> <i>Acremonium falciforme</i> <i>Actinomyadura madurae</i> <i>Nocardia brasiliensis</i>
Red grain	<i>Actinomyadura pelletieri</i>

Mycetoma is documented worldwide but is common in tropical and subtropical countries. Actinomycetoma accounts nearly for 65% of mycetomas and for 35% of eumycetoma in India. *Actinomyadura madurae* is the major causative agent. *Streptomyces somaliensis* infection is seen more frequently in eastern India. The condition is more common in rural areas and in males (3.5:1) than females. It affects mostly highly active persons aged 20–40 years. It is an occupational hazard affecting farmers, herdsmen, carpenters, builders, land workers, field workers, etc.

Mycotic mycetomas require surgical treatment by amputation, while actinomycotic mycetomas are treated well by sulfonamides and antibiotics.

## Key Points

- High index of clinical suspicion and proper history is essential for clinical diagnosis of mycetoma.
- Laboratory diagnosis depends on demonstration of the fungi and fungal filaments in granules, pus, and biopsy tissue by microscopy.
- The granules on naked eye examination may be hard or soft, round or lobulated, and vary in size from 0.5 to 3 mm. These may be black, white to cream, or red.
- Microscopy of the granules may reveal very thin fungal filaments, measuring less than 1  $\mu\text{m}$  in diameters in cases of actinomycotic mycetomas. However, the fungal filaments may be broader and often show septate hyphae and chlamydospores in mycotic mycetoma (Table 72-5).

## Chromomycosis

The term *chromomycosis* includes chromoblastomycosis and phaeohyphomycosis caused by dematiaceous fungi.

## Chromoblastomycosis

Chromoblastomycosis is a slowly progressing granulomatous infection caused by several soil fungi. These are *Fonsecaea pedrosoi*, *Fonsecaea compactum*, *Cladosporium carrionii*, and *Phialophora verrucosa*. These fungi are collectively called dematiaceous fungi because they have brown to black melanin pigment in their cell wall, and their conidia or hyphae are dark colored, either gray or black. All the fungi causing chromoblastomycosis appear

morphologically similar in tissues stained by hematoxylin and eosin (H and E) or other stains.

The infection occurs following introduction of any of the dematiaceous fungi into the skin through trauma. The development of warty nodules that appear at site of inoculation characterizes chromoblastomycosis. During the course of infection, these lesions vegetate and develop to a cauliflower-like lesion. The disease is more common in tropical and subtropical countries.

## Key Points

Laboratory diagnosis of chromoblastomycosis is made by demonstration of small clusters of round and dark brown, thick-walled cells (8–12  $\mu\text{m}$ ) in tissues. The fungi are found in the dermis but are occasionally seen in the subcutaneous tissues. Direct KOH wet mount of skin is a rapid method for diagnosis of the condition by demonstrating these fungi in scales removed from surface of these lesions. In addition to these, copper-colored spherical cells in various stages of cell division are seen. These are the tissue forms of the fungus and called sclerotic or medullar bodies (Fig. 72-4) of the fungus.

## Phaeohyphomycosis

Phaeohyphomycosis is a heterogeneous group of cutaneous diseases caused by various dematiaceous fungi. Phaeohyphomycotic cyst is the most common form described in this condition. A wide number of dematiaceous fungi have been associated with various types of phaeohyphomycosis. Some of the common causes of phaeohyphomycosis are *Exophiala jeanselmei*, *Bipolaris spicifera*, and *Wangiella dermatitidis*.

Diagnosis of phaeohyphomycosis is made by demonstration of darkly pigmented, septate hyphae measuring 5–10  $\mu\text{m}$  diameter in tissues. The drug of choice for treatment of chromoblastomycosis is 5-fluorocytosine. Caution and surgical removal of early lesion is also useful.

## Sporotrichosis

Sporotrichosis is a chronic pyogenic granulomatous lesion of the skin and subcutaneous tissue caused by *Sporothrix schenckii*. *S. schenckii* is a dimorphic fungus found all over the world. The fungus is found in soil, decaying woods, thorns, and on infected animals including rats, cats, dogs, and horses.

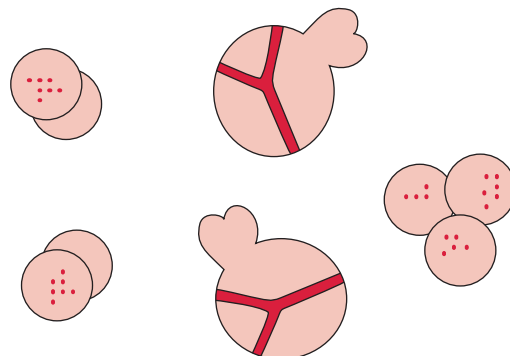

FIG. 72-4. Sclerotic bodies.

Spore is the infective stage of the fungus. It causes infection primarily on the hand or the forearm through direct contact of the skin by spores. Typically, infection is introduced in skin through a penetration of thorn. At the site of thorn injury, it causes a local pustule or ulcer with the nodules along the draining lymphatics. Frequently, the regional lymph nodes draining the ulcer enlarge, suppurate, and ulcerate.

The primary lesion may remain localized or in the immunocompromised individuals may disseminate to involve the bones, joints, lung, and rarely the central nervous system.

*S. schenckii* occurs in two phases. Yeast phase occurs in tissue and in culture at 37°C, while mycelium phase occurs in culture at 22–25°C.

In infected tissue, the yeast appears as round, oval, or cigar-shaped cells with irregular borders. Periodic acid-Schiff (PAS) or Gomori's methenamine silver (GMS) stain is useful to demonstrate these structures in the stained smears. The fungus on SDA at 25°C produces black and shiny colonies, which become wrinkled and foggy during course of time. The mold contains hyphae bearing flower-like structures of small conidia on delicate sterigmata.

Laboratory diagnosis of sporotrichosis is made by demonstration of asteroid bodies in pus of the abscesses. Asteroid bodies consist of a central basophilic budding yeast cell with eosinophilic material, which radiates from the center.

### Key Points

Isolation of the fungi by culture of ulcer exudates or pus aspirated from subcutaneous nodule or biopsy material confirms the diagnosis of sporotrichosis. LPCB wet mount of the colony shows thin, delicate hyphae bearing conidia occurring in a rosette pattern at the end of delicate conidiophores. Conidia are also demonstrated along the sides of the hyphae. Repeated subculture of mycelium of fungi on blood agar tubes at 37°C induces formation of yeast colonies. The LPCB wet mount of these colonies shows cigar-shaped yeast-like cells.

Itraconazole is the drug of choice for treatment of the condition.

## Rhinosporidiosis

Rhinosporidiosis is a chronic granulomatous disease caused by *Rhinosporidium seeberi*. More than 90% of cases are reported from India, Sri Lanka, and South America. The cases have been reported from throughout India. The endemic foci of infection

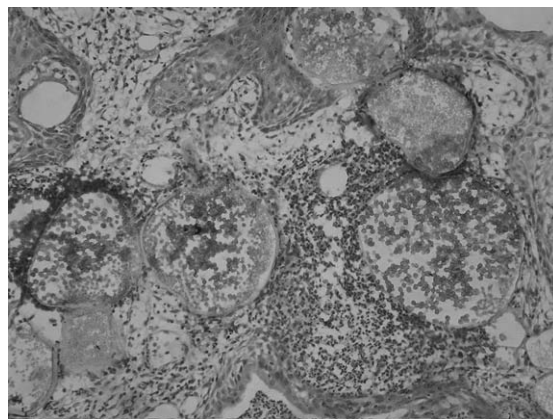

FIG. 72-5. Histology of *Rhinosporidium seeberi* granules ( $\times 1000$ ).

have been reported from Tamil Nadu, Andhra Pradesh, Kerala, and Madhya Pradesh.

*R. seeberi* cannot be cultured in cell-free artificial media. Animal inoculation is also not successful. The mode of infection of this fungus is not known. However, it is suggested that it is transmitted in dust and water. Fish is believed to be the natural host of this fungus. Infection is seen most commonly in persons taking bath in stagnant pools and in individuals who dive in streams to collect sand from river beds.

The disease is characterized by the development of large friable polyps or wart-like lesion in the nose, conjunctiva, or eye. The lesion is also occasionally seen in ears, larynx, bronchus, urethra, vagina, rectum, and skin.

### Key Points

Laboratory diagnosis of rhinosporidiosis depends on demonstration of sporangia of *R. seeberi* in tissue sections. *R. seeberi* can be demonstrated in tissue sections stained with H&E or other special stains, such as GMS stain and PAS stain. The stained smear on microscopic examination shows a hyperplastic surface epithelium with the presence of chronic inflammatory exudates. The epidermis and stroma are embedded with sporangia (Fig. 72-5). The sporangia measure 10–200  $\mu\text{m}$  in diameter and contain hundreds of endospores, each measuring 6–7  $\mu\text{m}$  in diameter. The spores when released develop into new sporangia.

Treatment of the condition is carried out by surgery or cauterization. Chemotherapy with dapsone is also useful.



### CASE STUDY

A mother comes to dermatology with her 10-year-old child with complaints of scaly and patchy alopecia. On examination by a dermatologist, the condition was suspected to be tinea capitis.

- How will you confirm the diagnosis of tinea capitis?
- What are the clinical features of tinea capitis, tinea pedis, and other teniae due to anthropophilic, zoophilic, and geophilic fungi?
- How will you treat the condition?

# Systemic Mycoses

## Introduction

Systemic mycoses are caused by fungi of soil, which are inherently virulent and cause disease in healthy humans. The systemic mycoses include coccidioidomycosis, paracoccidioidomycosis, histoplasmosis, blastomycosis, and cryptococcosis.

## Coccidioidomycosis

Coccidioidomycosis caused by *Coccidioides immitis* was first recognized as a distinct disease entity in 1892. *C. immitis* is a dimorphic fungus, which occurs as a mold in soil and in culture at 25°C and as a spherule in tissue and in culture at 37°C. The spherule is oval with a thick, double refractile wall that is filled with endospores. Each endospore, measuring 2–5 μm in diameter gives rise to a new spherule.

*C. immitis* grows in mycelial form in the soil of endemic areas. Subsequently, the hyphal cells either develop into barrel-shaped structures or shrink and die, producing the characteristic arthroconidia. The arthroconidia are the infective stage of the fungus. When the soil is disrupted, the arthroconidia become air-borne and if inhaled by a susceptible host, initiate the infection.

The arthrospore inside the pulmonary acinus gives off its outer layer, swells, and develops to a spherical structure called the spherule. The spherule is the parasitic stage of the organism, which reproduces by a process known as endosporulation. Rupture of the spherule leads to release of endospores, each of which matures into spherules and the cycle is repeated. If the organism is cultured, it re-enters the mycelial phase with hyphae formation.

The spherule is the characteristic tissue form of the organism. Resistance of the spherule to eradication by host defenses is the main factor in the pathogenesis of disease. Spherules cause progressive suppuration and tissue necrosis.

More than half of the cases are asymptomatic. In symptomatic cases, *C. immitis* causes a primary pulmonary disease and disseminated disease. Pulmonary infection is the most frequent presentation in symptomatic patients. In disseminated disease, virtually every tissue of the body including central nervous system (CNS), skin, and bones is involved. The condition is uncommon, but is highly fatal.

*C. immitis* has a distribution restricted primarily to areas of the Western hemisphere. The southern-central part of

California (San Joaquin Valley), Arizona, southern New Mexico, western Texas, and northern Mexico are the areas of highest endemicity.

Laboratory diagnosis of coccidioidomycosis is made by demonstration of spherules containing endospores in (a) sputum, or smears from the lesion stained by calcofluor white and (b) in biopsy material stained by hematoxylin and eosin, silver, or periodic acid-Schiff stains. Culture is the most definitive method for diagnosis. The fungus grows well on Sabouraud's dextrose agar (SDA) and other media producing white and cottony colony within 5 days. Identification of colonial morphology is not adequate, because other fungi show similar mycelial forms. Therefore, demonstration of typical arthroconidia is useful to identify the organism. However, arthroconidia are infectious, hence pose a significant risk to laboratory personnel.

Serodiagnosis of coccidioidomycosis is based on the demonstration of antibodies to coccidioidal antigens in patient's serum. Tube-precipitating antigen and the complement-fixation antigen are the two major antigens used to detect antibodies. Enzyme immunoassay (EIA) is the most frequently used test to detect serum tube-precipitating antibodies that are IgM antibodies to mycelial phase antigens. These IgM antibodies appear in more than 85% of patients with primary infection and are found within the first week after the onset of symptoms. In most patients, these antibodies disappear within 6 months. IgG antibodies detected by complement fixation appear later, with results becoming positive in 85–90% of patients.

## Key Points

Skin test using coccidioidal antigens is used for diagnosis of coccidioidomycosis. It is a delayed-type hypersensitivity reaction that appears 2–21 days after the onset of symptoms and precedes the appearance of serologic markers. Skin test has epidemiologic and prognostic implications. Absence of delayed-type hypersensitivity indicates poor prognosis. However, the skin test has limited diagnostic utility because of its low sensitivity and specificity in endemic areas. Infected individuals may show negative results due to absence of an immune response and healthy individuals may show positive results because of previous infection.

DNA probe is a recent method used for accurate identification of the fungus.

Amphotericin B is the drug of choice for treatment of the condition. Fluconazole can be used for the treatment of mild

to moderate disease and, occasionally, for the treatment of life-threatening disease in patients in whom amphotericin B is contraindicated for use. It is used as the drug of choice for long-term therapy of meningeal infection.

## Paracoccidioidomycosis

Paracoccidioidomycosis, also known as South American blastomycosis and Lutz-Splendore-Almeida disease, is a chronic progressive systemic mycosis caused by *Paracoccidioides brasiliensis*. *P. brasiliensis* is a thermally dimorphic fungus found in the soil. It occurs as a mold in the soil and as a yeast in tissue. These yeasts are unique in that one large mother cell produces multiple blastoconidia (daughter cells) that arise from multiple sites, resembling a “Mickey Mouse head” or a “pilot wheel.” This characteristic appearance helps to differentiate this yeast from *Blastomyces dermatitidis* and all other yeasts.

Infection occurs by inhalation of conidia or mycelial fragments. The lungs are the primary site of infection. From this site, the fungus then disseminates to other organs through the venous and lymphatic systems. Cell-mediated immunity (CMI) is the most important defense mechanism in an immunocompetent host. However, most initial infections are subclinical.

In adults, the course of disease is long-term and the outcome is better with appropriate therapy. Pulmonary infection is the most common manifestation. The disease in younger patients is subacute and carries a worse prognosis.

Paracoccidioidomycosis has a restricted geographical distribution. It is found in South and Central America. The highest incidence is in the southeast province of Brazil, followed by Colombia, Venezuela, Ecuador, and Argentina.

*P. brasiliensis* causes natural infection only in armadillos. Bats and saguis may serve as reservoirs. The infection is transmitted by inhalation of conidia or mycelial fragments that are found in the soil. Direct inoculation of the skin or oral mucous membranes is uncommon. However, it may occur from the use of twigs to clean teeth, which is commonly practiced in rural Brazil. The infection can also be transmitted orally by ingestion. Person-to-person transmission does not occur.

Laboratory diagnosis depends on demonstration of large, multiple budding yeasts (blastoconidia) in 30% KOH wet mount preparation of sputum. Gomori’s methenamine silver (GMS) staining of biopsy specimens shows yeast cells measuring 2–30  $\mu\text{m}$  in diameter. Tissue reactions are diffuse in the juvenile form, while granuloma formation is typical in the adult form. The organism is isolated by culture on SDA at 37°C after 20–30 days.

### Key Points

Serodiagnosis depends on demonstration of *P. brasiliensis* antibodies or antigens in the serum. Enzyme-linked immunosorbent assay (ELISA) is used to detect antibodies to gp43, the main antigenic determinate of *P. brasiliensis* with a reported

sensitivity of 95% and a specificity of 93%. The test shows cross-reactivity with sera from patients of histoplasmosis or Lobo disease. Western blot detects circulating antibodies to gp43 in the serum in 100% of patients and to gp70, another antigen of the fungus, in 96% of patients. Newer tests that detect Ag7, i.e., antigen found after 7 days of growth, have a sensitivity of 84% and specificity of 99%. This antigen detection test is used to monitor patient response to therapy and to detect recurrences. However, skin tests are rarely helpful.

Itraconazole is the drug of choice for treatment of paracoccidioidomycosis and is effective in 95% of patients. Imidazole is also an effective agent with a cure rate of 85–90%. Amphotericin B is used as a reserve for treatment of severe cases that are refractory to treatment with these drugs.

## Histoplasmosis

Histoplasmosis is primarily a disease of reticuloendothelial system caused by an intracellular fungus *Histoplasma capsulatum*. *H. capsulatum* is a dimorphic fungus, which occurs in two stages: as a mold in soil and as yeast at body temperature in mammals. On SDA medium at 37°C, this fungus produces cottony mycelial growth. The colony is characterized by thin, branching, septate hyphae that produce tuberculate macroconidia and microconidia. The macroconidia are thick-walled, spherical spores measuring 8–20  $\mu\text{m}$  in diameter and have finger-like projections. These are diagnostic form of the fungus. The microconidia are smaller and thin-walled spores, and are the infectious form of the fungus.

The parasitic or tissue phase of the fungus is a yeast that measures 2–4  $\mu\text{m}$  in diameter. It is exclusively found within macrophages in the infected host.

*H. capsulatum* infection is acquired by inhalation of conidia and mycelial fragments from contaminated soil. Once inhaled, it is deposited in alveoli of the lung and transformation from the mycelial to the pathogenic yeast form occurs intracellularly inside the macrophages. The yeast inside the macrophages multiplies in approximately 15–18 hours. Multiplication continues within the phagosomes despite fusion with lysosomes. This is possibly due to production of certain proteins by yeasts that inhibit the activity of lysosomal proteases.

CMI is key component of host defense against the fungus. T lymphocytes are crucial in limiting the extent of infection. In persons with impaired CMI, *Histoplasma* species which remained latent in healed granulomas may be reactivated, resulting in histoplasmosis.

Most infected individuals are asymptomatic. Nevertheless, *H. capsulatum* causes acute pulmonary histoplasmosis, chronic pulmonary histoplasmosis, and progressive disseminated histoplasmosis. Majority of patients with acute pulmonary histoplasmosis are asymptomatic. Incubation period varies from 3 to 14 days. Fever, headache, malaise, myalgia, abdominal pain, and chills are common symptoms. Cough, hemoptysis, dyspnea, and/or chest pain may be present. Chronic pulmonary histoplasmosis is seen in patients with underlying pulmonary disease. Cough, weight loss, fevers, and malaise are symptoms.

Progressive disseminated histoplasmosis is seen in patients who are immunocompromised, such as patients with AIDS.

*H. capsulatum* is predominantly found in river valleys in North and Central America. It is endemic in the Ohio, Missouri, and Mississippi River valleys of the United States.

In endemic areas, the soil provides an acidic, damp environment with high organic content, which favors the growth of fungal mycelia. Bats play an important role in transmission of the disease. They can become infected, and they transmit the fungus through their droppings. The soil contaminated with birds' excretions and droppings of bats remains highly infectious for years. Moreover, human infection occurs following inhalation of spores from contaminated soil.

Laboratory diagnosis depends on demonstration of oval yeast cells within macrophages in bone marrow aspirates and in tissue biopsy specimens. Biopsy of oropharyngeal ulcers is usually diagnostic (refer the box Biopsy). Culture of sputum and blood on SDA at 25°C shows hyphae with tuberculoid macroconidia and at 37°C shows yeasts. Sputum culture is positive in approximately 10–15% patients with acute pulmonary histoplasmosis and in 60% of patients with chronic pulmonary histoplasmosis. Complement-fixation test (CFT) and immunodiffusion (ID) are useful serological tests for demonstration of specific antibodies in serum. The CFT titer greater than 1:8 is considered positive. A titer of 1:32 or more suggests active histoplasmosis. Cross-reactivity with antigens from *B. dermatitidis* and *C. immitis* is a noted problem that may give rise to a false-positive reaction. The ID test detects antibodies to two glycoproteins, H and M, of *H. capsulatum*. Anti-H antibody is more specific for active histoplasmosis, is positive in 50–80% of patients, and remains elevated for years.

## Key Points

Detection of specific *H. capsulatum* antigen in serum and urine is useful in immunocompromised hosts when antibody production may be impaired. They are usually positive in case of acute progressive disseminated histoplasmosis. Histoplasmin skin test detects a delayed-type hypersensitivity to histoplasmal antigens that occurs 3–6 weeks after exposure. A positive skin test indicates a past or present infection, but does not differentiate between active and past infections. It is positive in approximately 85–90% immunocompetent individuals. DNA probes and polymerase chain reaction (PCR) are also used for diagnosis of the condition.

Amphotericin B is the drug of choice for treatment of disseminated disease. Fluconazole is often recommended for meningitis due to its better penetration of the cerebrospinal fluid (CSF). Asymptomatic or mild condition needs no treatment.



## Biopsy

Tissue biopsy smear stained by hematoxylin and eosin may show the presence of yeast forms in tissue. Yeast may be detected in areas of caseation necrosis and calcified lymph nodes by using Grocott–Gomori methenamine silver stain. Yeast forms are rarely seen in stained peripheral blood smear.

## Blastomycosis

Blastomycosis is a granulomatous fungal infection caused by *B. dermatitidis*. *B. dermatitidis* is a dimorphic fungus, which occurs in two stages: as mold in soil and as yeast in tissue. On culture at 37°C and in tissue, the yeast is a round structure with a double refractile wall and a single broad-based bud. This appearance helps to differentiate it from the *Cryptococcus neoformans* yeast, which has a narrow-based bud. On culture at 25°C, the fungus produces a mycelial growth showing typical pyriform microconidia, which measure 2–4 μm in diameter.

*B. dermatitidis* infection occurs by inhalation of microconidia found in soil, its natural habitat. Inside the lungs, the conidia are transformed to the yeast phase at body temperature. The thick cell wall of the yeasts offers resistance to phagocytosis and induces expression of blastomyces adhesin 1 (BAD1), an immune-modulating virulence factor on the cell surface. Then, the yeasts replicate and may disseminate through the blood and lymphatics to other organs to cause the disease.

Pulmonary infection is the major clinical manifestation. A flu-like illness with fever, chills, myalgia, headache, and a nonproductive cough may occur, which resolves within days. In some cases, it may develop to a progressive pulmonary disease or may result in extrapulmonary dissemination. Extrapulmonary dissemination to other organs, more often, occurs in patients with chronic pulmonary illness and in those who are immunocompromised. The skin is the most common site of extrapulmonary blastomycosis.

Blastomycosis is documented from the United States and also from Canada and the African continent. In endemic areas, blastomycosis is a common infection among dogs. It is also reported in horse, cow, cat, bat, and lion. Microconidia are the infective stages that are present in the soil. Infection is transmitted to humans through inhalation of aerosolized conidia.

## Key Points

- Sputum microscopy is a very useful test for demonstration of characteristic broad-based budding yeasts of *B. dermatitidis*. KOH wet mount of pus aspirated from skin microabscesses, fistulae, or subcutaneous abscesses is useful to demonstrate the yeast.
- Sputum culture on SDA medium confirms diagnosis of the condition. However, it may take as early as 5 days or as late as 30 days for colony formation.
- ELISA is a useful test to detect antibodies against A antigen of *B. dermatitidis* in the patient's serum. A titer of greater than 1:32 is suggestive of the condition. Radioimmunoassays (RIAs) and Western blot techniques are the newer tests that use more specific cell wall antigens of *B. dermatitidis* for detection of antibodies in the serum.
- Skin test is not reliable for diagnosis.

Amphotericin B and itraconazole are the drugs of choice for treatment of blastomycosis.

## Cryptococcosis

Cryptococcosis, also called European blastomycosis, is an acute to chronic disease caused by an encapsulated yeast, *C. neoformans*. Cryptococcosis is the most common life-threatening fungal disease in patients with AIDS. It is the only systemic mycosis frequently documented from India.

Of the 19 species that comprise the genus *Cryptococcus*, human disease is associated with only *C. neoformans*. *C. neoformans* was first described by Busse, a pathologist, in 1984.

Kwon-Chung (1976) have described the perfect (i.e., sexual, teleomorphic) form of *C. neoformans*, which was named *Filobasidiella neoformans*. Prior to the identification of *F. neoformans*, which is mycelial, *C. neoformans* was considered monomorphic yeast.

## Morphology

- *C. neoformans* is a true yeast.
- It is an oval and budding cyst and measures 3–6 μm in diameter. The yeast may be single or may have a single budding daughter cell.
- Within the host and in certain culture media, the yeast is surrounded by a wide polysaccharide capsule. The polysaccharide capsule is composed of mannose, xylose, and glucuronic acid. This fungus forms a narrow-based bud in contrast to that of *B. dermatitidis*, which forms a broad-based bud. Rarely, pseudohyphae develop.
- *C. neoformans* on SDA medium forms smooth, convex, cream-colored colonies at 20–37°C. Lactophenol cotton blue (LPCB) wet mount of the colony shows budding yeast cells.

*C. neoformans* has two varieties: *C. neoformans* var *neoformans* and *C. neoformans* var *gattii*. Based on antigenic specificity of the capsular polysaccharide, the species has been classified into four serotypes. These are serotypes A and D (*C. neoformans* var *neoformans*) and serotypes B and C (*C. neoformans* var *gattii*).

## Pathogenesis and Immunity

The immune status of the host is the crucial factor in pathogenesis of cryptococcosis. *C. neoformans* usually causes most serious infections in patients with impaired CMI. These include:

- patients with AIDS,
- patients undergoing corticosteroid treatment,
- patients undergoing organ transplantation,
- patients with reticuloendothelial malignancy, and
- patients with sarcoidosis.

*C. neoformans* is primarily transmitted by inhalation (Fig. 73-1). Following inhalation, the yeasts are deposited into the pulmonary alveoli, in which they survive before they are phagocytosed by alveolar macrophages. Glucosylceramide synthase has been identified as an essential factor in the survival of *C. neoformans* in pulmonary alveoli.

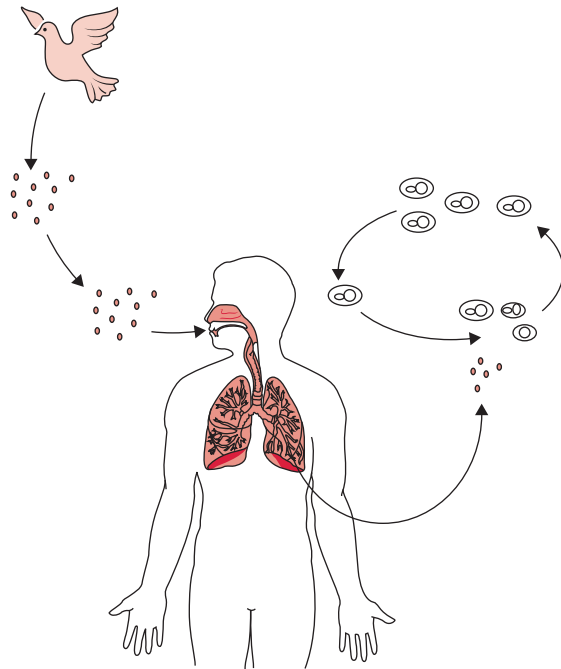

FIG. 73-1. Transmission of *Cryptococcus neoformans*.

Cryptococcal polysaccharide capsule has antiphagocytic properties. Hence, unencapsulated yeast are readily phagocytosed and destroyed than the encapsulated organisms, which are more resistant to phagocytosis. The antiphagocytic properties of the capsule prevent recognition of the yeast by phagocytes and inhibit leukocyte migration into the area of fungal replication.

### ► Host immunity

The host immunity in cryptococcal infection is mediated by both cellular and humoral responses. CMI is mediated by natural killer cells and T lymphocytes can inhibit or kill cryptococci. An increase in helper T-cell activity, skin test conversion, and a reduction in the number of viable organisms in the tissues indicates a successful host response against the fungus.

Humoral immunity is mediated by anticryptococcal antibodies and soluble anticryptococcal factors. Both anticryptococcal antibodies and the complement play a crucial role in facilitating the macrophage- and lymphocyte-mediated immune response to the organism.

## Clinical Syndromes

*C. neoformans* causes (a) pulmonary cryptococcosis in immunocompetent hosts and in immunocompromised hosts, (b) CNS cryptococcosis, and (c) disseminated nonpulmonary non-CNS cryptococcosis.

### ► Pulmonary cryptococcosis

The clinical manifestations of pulmonary cryptococcosis are widely variable. Pulmonary disease varies from asymptomatic colonization of the respiratory tract to acute respiratory distress syndrome affecting immunocompromised hosts. It depends on the immune status of the host.

## ► CNS cryptococcosis

Both the brain and meninges are involved in cryptococcal infection of the CNS infections. Meningitis and meningoencephalitis are the most common manifestations. These are usually subacute or chronic in nature. Without specific therapy, the infection is invariably fatal. The patient dies due to the disease 2 weeks to several years after the symptom onset.

## ► Disseminated nonpulmonary non-CNS cryptococcosis

Disseminated cryptococcosis includes the skin, prostate, and medullary cavity of the bones, next only to the lungs and CNS, and it occurs most commonly in patients with AIDS and other immunosuppressed conditions.

## Epidemiology

*C. neoformans* is distributed worldwide. The incidence of cryptococcosis is increasing and now it represents a major life-threatening fungal infection in patients with AIDS. Most cases of cryptococcosis are caused by serotypes A and D. *C. neoformans* var *gattii* is the most common variety that causes disease in immunocompetent patients. *C. neoformans* var *neoformans* is the most common variety that causes disease in immunocompromised patients, e.g., AIDS. *C. neoformans* is primarily transmitted by inhalation (Fig. 73-1). Human-to-human transmission does not occur.

## Laboratory Diagnosis

Laboratory diagnosis of cryptococcal infection is made by demonstration of the yeast in CSF, sputum, pus, and brain biopsy tissue by smear and culture. Methenamine silver or periodic acid-Schiff stains are used to stain the tissue specimens for demonstration of the capsule of *C. neoformans*. Fixed tissue may also be stained with mucicarmine, which preferentially stains *C. neoformans*.

India ink preparation is commonly used to detect budding yeast cells in the CSF (Fig. 73-2). The capsule appears as a clear halo around the yeast cells. By this method, cryptococci can be demonstrated in 25–50% of patients with cryptococcal meningitis.

Gram-stained smear of the CSF shows Gram-positive yeast cells (Color Photo 63).

The culture of centrifuged CSF specimens confirms diagnosis of the condition. This fungus is identified based on

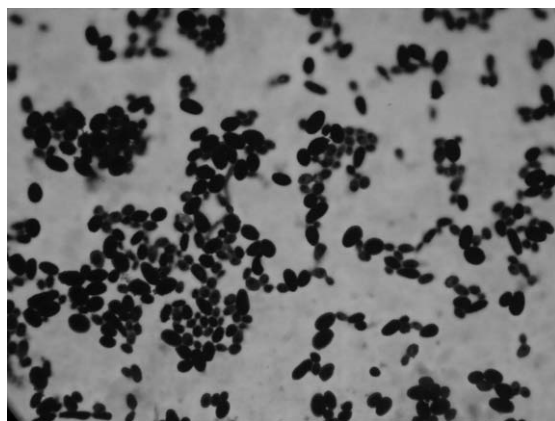

**FIG. 73-2.** India ink preparation showing capsule of *Cryptococcus neoformans* ( $\times 400$ ).

its microscopic appearance, biochemical test results, and ability to grow at 37°C (98.6°F).

## Key Points

**Pathogenic *C. neoformans* shows the following properties:**

- It grows at 37°C (98.6°F), assimilates inositol, produces urease, and does not produce mycelia on cornmeal agar.
- It also produces melanin when incubated on agar that contains seeds from the common weed *Guizotia abyssinica*.
- It does not assimilate lactose and nitrates or produce pseudomycelia on cornmeal or rice-Tween agar.

Latex agglutination test (LAT) is a frequently used serological test to detect cryptococcal polysaccharide antigen in the serum or CSF for diagnosis of meningitis. LAT is an extremely important adjunct to the diagnosis.

## Treatment

Amphotericin B is the drug of choice for initial therapy in meningitis or other disseminated infections caused by *C. neoformans*. Amphotericin B may be used alone or in combination with flucytosine. The therapeutic goal for patients with cryptococcal disease not complicated by HIV infection is to achieve a permanent cure of the fungal infection. The therapeutic goal for patients with concomitant HIV infection without a CD4 count of greater than 100 cells/ $\mu$ L is to control the acute infection, followed by lifelong suppression of *C. neoformans*.

## CASE STUDY

A 32-year-old man who is HIV-antibody positive is brought to the emergency room with headache and fever for the past 3 days. According to family members, he has been confused, forgetful, and irritable for the last 2 weeks prior to the onset of these symptoms. Spinal fluid examination reveals numerous white blood cells, predominantly lymphocytes budding yeasts with a wide capsule in India ink preparation.

- Suggest the clinical diagnosis of the condition.
- Mention the laboratory methods for diagnosis of the condition.
- List the persons who are more susceptible to the condition.
- How will you treat the condition?

# Opportunistic Fungal Infections

## Introduction

The opportunistic fungi usually cause infections in persons with impaired host defense, but do not cause disease in most of the immunocompetent hosts. Since these fungi become pathogens in individuals with impaired immunity by taking advantage of the host's debilitated conditions, they are called opportunistic fungi.

In recent times, there is an increasing list of exotic and rare fungi, which have been associated to cause opportunistic infections. But most opportunistic infections are caused by *Candida albicans*, *Aspergillus* spp., *Penicillium marneffei*, and various Zygomycetes (Table 74-1).

## Candidiasis

*Candida* species are the most common fungal pathogens that affect humans. These species are true opportunistic pathogens that take advantage of the host's debilitated condition and gain access to the circulation and deep tissues. The genus *Candida* includes more than 100 species, of which only few cause disease in humans. *C. albicans* and occasionally other species cause candidiasis, a major infection in immunocompromised hosts.

TABLE 74-1

Common opportunistic infections

Disease	Causative fungus
Candidiasis	<i>Candida albicans</i> , <i>Candida tropicalis</i> , and other species
Aspergillosis	<i>Aspergillus fumigates</i> , <i>Aspergillus flavus</i> , <i>Aspergillus niger</i> , and other species
Zygomycosis	<i>Mucor</i> , <i>Rhizopus</i> , and <i>Absidia</i> species
<i>Pneumocystis carinii</i> pneumonia (PCP)	<i>Pneumocystis jiroveci</i>
Penicilliosis	<i>Penicillium marneffei</i>
<i>Pseudoallescheria boydii</i> infection	<i>Pseudoallescheria boydii</i>
<i>Fusarium solani</i> infection	<i>Fusarium solani</i>
Meningitis	<i>Cryptococcus neoformans</i>

## *Candida albicans*

*C. albicans* is the most common *Candida* species, which causes opportunistic infections in immunocompromised hosts. It forms the part of the normal flora of the mucous membrane of the gastrointestinal, genitourinary, and respiratory tract.

## Properties

- *C. albicans* is ovoid or spherical yeast with a single bud.
- It forms the part of the normal flora of the mucous membrane of the gastrointestinal, genitourinary, and respiratory tract. It produces pseudohyphae in the cultures and in tissues. Pseudohyphae are elongated yeast that may resemble hyphae morphologically, but are really not true hyphae. *Candida* grows readily on Sabouraud's dextrose agar and on bacteriological culture media. *C. albicans* produces creamy white, smooth colonies with a yeasty odor (Color Photo 64).
- It can be differentiated from other *Candida* species by carbohydrate fermentation reaction and by characteristic growth properties.
- Only *C. albicans* produces chlamydo spores on cornmeal agar culture at 25°C.

## Pathogenesis and Immunity

*Candida* spp. are usually present as part of normal flora on healthy mucosal surface of the oral cavity, gastrointestinal tract, and vagina. *Candida* shows colonization at these sites in more than 80% of healthy people. The organism, however, is rarely present on the surface of normal human skin, except occasionally from certain intertriginous area, such as the groin.

### ► Pathogenesis of *Candida* infection

Under certain conditions, *Candida* gains access to systemic circulation from the oropharynx of the gastrointestinal tract. Colonization of the mucocutaneous surface is the first stage in the pathogenesis of Candidal infection. The fungus causes invasion in human tissue through different routes. Disruption of the skin or mucosa allows the organism access to the blood stream. Massive colonization with large numbers of *Candida* also permits the organism to pass directly into the blood stream, causing the infection.

In immunocompromised hosts, *Candida* may disseminate to many organs, such as lung, spleen, liver, heart, and brain. *Candida*



may induce inflammation of the eye, causing endophthalmitis and also may involve skin in 10–30% of patients with disseminated infection. Deficiency in host defence mechanisms plays a significant role in development of *Candida* infection.

### ► Host immunity

Both cell-mediated and humoral antibodies confer protection against *Candida* in healthy adults. Cell-mediated immunity (CMI) is, however, most important. Alteration in CMI may cause extensive superficial candidiasis, despite having normal or elevated humoral antibodies. The humoral antibodies appear to play minimal role in protection against the disease. Humoral antibodies confer protection against *Candida* in healthy adults.

## Clinical Syndromes

*Candida* causes a wide spectrum of clinical illnesses as follows:

**Cutaneous candidiasis:** *Candida* species in immunocompetent host can cause infection of any warm and moist part of the body exposed to environment. It causes infection of the nail, rectum, and other skin folds.

**Mucocutaneous candidiasis:** Mucocutaneous candidiasis (thrush, perianal disease, etc.) is the most common manifestation of candidiasis, but usually does not cause any mortality. In patients with advanced immunodeficiency due to HIV infection, *Candida* species can cause severe oropharyngeal and esophageal candidiasis that result in poor intake of food, leading to malnutrition, wasting, and early death. These patients are also usually resistant to treatment with antifungal therapy.

**Chronic mucocutaneous candidiasis:** This is a heterogeneous group of clinical syndromes. This syndrome is characterized by chronic, treatment-resistant, superficial *Candida* infection of the skin, nails, and oropharynx. However, these patients do not show any evidence of disseminated candidiasis.

**Systemic candidiasis:** These include endocarditis, gastrointestinal tract candidiasis, respiratory tract candidiasis, genitourinary candidiasis, and hepatosplenic candidiasis. Systemic candidiasis may be candidemia and disseminated candidiasis. In patients with AIDS, oral thrush and *Candida* esophagitis are more common but not candidemia and disseminated candidiasis. *Candida* endophthalmitis and central nervous infection (CNS) infection due to *Candida* species are other complications of *Candida* infection.

**Disseminated candidiasis:** This is increasingly becoming a problem in patients with serious hematologic malignancies that are treated with immunosuppressive drugs for over a long period of time. Severe neutropenia in these patients is the most important predisposing condition for life-threatening infection caused by *Candida*. In this condition, *Candida* usually spreads through the circulation and involves many organs, such as lungs, spleen, kidney, liver, heart, and brain.

However, disseminated candidiasis is not a major problem in patients with AIDS. In such patients, serious infection of the oropharynx and the upper gastrointestinal tract is the

major problem. The development of these conditions in previously healthy individuals not receiving broad-spectrum antibiotic therapy should be strongly suspected for possibility of infection with HIV.

## Epidemiology

*Candida* species is distributed worldwide. In recent times, *Candida* species have replaced *Cryptococcus* species as the most common fungi affecting the CNS of immunocompromised patients worldwide. *C. albicans* and *Candida glabrata* are responsible for causing infection in 70–80% of patients with invasive candidiasis. *Candida tropicalis* is an important cause of candidemia in patients with leukemia and in those who have undergone bone marrow transplantation. *Candida parapsilosis* is an important pathogen associated with the use of vascular catheters.

Since *Candida* is present as a part of normal flora already in the skin and mucous membrane of the host, it causes infection in the infected host; it is therefore not transmitted.

## Laboratory Diagnosis

### ► Specimens

These include exudates or tissues for microscopy obtained from skin or nails examined by microscope for demonstration of pseudohyphae or budding yeast cells of *Candida*.

### ► Microscopy

Gram-stained smear of the exudates or tissue shows Gram-positive, oval, budding yeast and pseudohyphae (Fig. 74-1, Color Photo 65). Since *Candida* is found as a part of normal flora on normal skin or mucosa, only the presence of large numbers of *Candida* is of significance. Demonstration of pseudohyphae indicates infection, and tissue invasion is of more diagnostic value.

### ► Culture

Culture on Sabouraud's dextrose agar (SDA) produces typical creamy white, smooth colonies. Different *Candida* species are

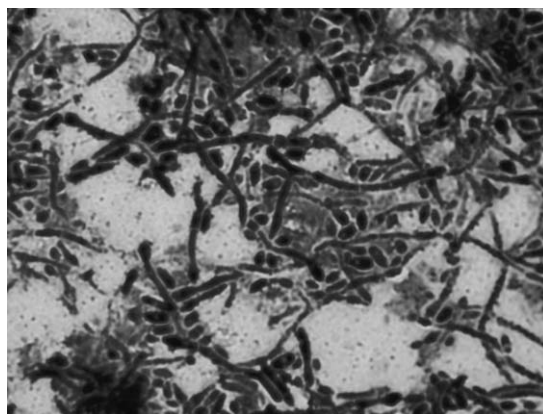

**FIG. 74-1.** Gram-stained smear showing Gram-positive, oval, budding yeast and pseudohyphae (×1000).



FIG. 74-2. *Candida albicans* showing formation of the germ tube ( $\times 400$ ).

identified by their growth characteristics, sugar fermentation, and assimilation tests. Germ tube is a rapid method for identification of *C. albicans* and *Candida dubliniensis*. This test depends on the ability of *C. albicans* to produce germ tube within 2 hours when incubated in human serum at 37°C. This phenomenon is called *Reynold-Braude phenomenon* (Fig. 74-2, Color Photo 66). Chlamydospores are typically produced by *C. albicans* on cornmeal agar at 25°C, but not by other *Candida* species. Moreover, CHROM agar allows for the presumptive identification of several *Candida* species by using color reaction in specialized media, thereby showing different colors of the colonies depending on the *Candida* species. Different *Candida* species can also be identified with more accuracy by biochemical assays, such as AP120C and AP131C. These assays evaluate the assimilation of various sugars for identification of different fungal species.

### ► Nonculture Candida detection tests

These include (a) *Candida* mannan assay, (b) *Candida* heat-labile-antigen assay, (c) D-arabinitol assay, (d) D-inositol assay, and (e) 1,3-beta-D-glucan assay. Beta-D-glucan assay is a broad-spectrum test that detects *Candida* as well as *Aspergillus*, *Fusarium*, *Acremonium*, and *Saccharomyces* species. This test depends on the principle that beta-D-glucan is a component of the cell wall of these fungi, which can be detected by its ability to activate factor G of the horse-shoe crab coagulation cascade. This test is a highly specific and sensitive test.

### ► Immunological tests

Serological tests are not that useful in diagnosis of patients with candidiasis because antibodies against *Candida* appear in sera of patients as well as in that of normal persons. Skin test with *Candida* antigen is a delayed hypersensitivity skin test, which is used as an indicator of functions of the CMI. The skin test is uniformly positive in immunocompetent adults and indicates that the person has intact CMI. The skin test is negative in individuals who have deficient CMI. Such a person is anergic and is negative to other skin tests, such as purified protein derivative (PPD) skin test for tuberculosis.



### Molecular Diagnosis

DNA probe and polymerase chain reaction (PCR) are still under evaluation, but appear to be promising.

### Treatment

Antifungal therapy forms the mainstay of treatment of the infections caused by *Candida*. These agents include azoles (fluconazole, triazole, ketoconazole), nystatin, and amphotericin B. *C. glabrata* is becoming increasingly important worldwide and is intrinsically less susceptible to amphotericin B and other azoles (ketoconazole, fluconazole, etc). *Candida krusei* is increasingly recognized because of its resistance to many antifungal agents. It is intrinsically resistant to ketoconazole and fluconazole. It is also less susceptible to all other antifungal agents including itraconazole and amphotericin B. *C. lusitanae* is also of clinical significance because it is resistant to amphotericin B, but it is susceptible to azoles and echinocandins.

### Prevention and Control

Antifungal prophylaxis is indicated for patients with invasive candidiasis who are at high risk of developing invasive candidiasis. There is no vaccine available against candidiasis.

### Aspergillosis

A broad spectrum of diseases in humans ranging from direct invasion to hypersensitive reactions are caused by *Aspergillus* species. Although more than 100 species have been described, the majority of human diseases are caused by *Aspergillus fumigatus* and *Aspergillus niger*, and less frequently by *Aspergillus flavus* and *Aspergillus clavatus*.

### Aspergillus Species

#### Properties

- *Aspergillus* species are molds.
- They have septate hyphae that form V-shaped dichotomous branches (Fig. 74-3). The *Aspergillus* species are identified by (a) their morphological features, (b) the pattern of conidiophore development, and (c) the color of the conidia.
- The presence of septate hyphae that branch at 45° angles is the typical feature of *Aspergillus* species hyphae. The hyphae in tissues are best demonstrated with silver stains. The walls of the hyphae are more or less parallel, unlike those of *Mucor* and *Rhizopus*, which are more or less irregular.
- Lactophenol cotton blue (LPCB) preparation of the colonies shows septate hyphae and branching conidiophores. Asexual conidia arranged in chains are present on elongated cells known as sterigmata. The latter is present on the vesicle of the conidiophores. The conidia of *Aspergillus* typically

form radiating chains in contrast to *Rhizopus* and *Mucor*, which are found within sporangia.

- The fungus grows rapidly on SDA and other culture media at 25°C. *Aspergillus* produces colonies within 1–2 days and shows a velvety surface.

## Pathogenesis and Immunity

*Aspergillus* species rarely cause infections in immunocompetent individuals. They cause invasive infections mostly in the patients who are immunocompromised either due to (a) use of immunosuppressive drugs, (b) underlying lung diseases, or (c) immunodeficiency diseases, such as HIV. In immunocompromised host, *Aspergillus* species cause invasion of the blood, thereby causing infarction, hemorrhage, and necrosis of lung tissues. *Aspergillus* spp. also produces toxic metabolites that inhibit macrophage and neutrophil phagocytosis, facilitating dissemination of the infection.

*Aspergillus* species unlike *Candida* species do not form the part of normal flora of humans. They are ubiquitous in the environment; hence transmission of infection is mostly exogenous.

## Clinical Syndromes

In immunocompetent hosts, *Aspergillus* species may primarily affect the lungs, causing four main syndromes including (a) allergic bronchopulmonary aspergillosis, (b) chronic necrotizing aspergillus pneumonia, (c) aspergilloma, and (d) invasive aspergillosis.

**Allergic bronchopulmonary aspergillosis:** It is a hypersensitivity reaction to *A. fumigatus* organisms, which have colonized in tracheobronchial tree. This condition occurs often in association with asthma and cystic fibrosis.

**Chronic necrotizing pulmonary aspergillosis:** It is a subacute infection seen in patients with some degree of immunosuppression. The condition occurs in conjunction

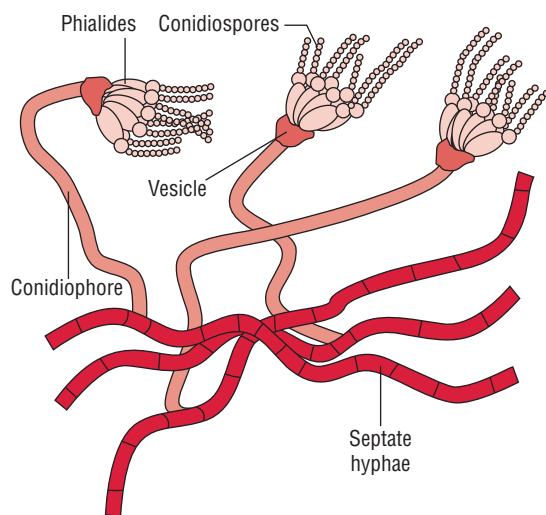

**FIG. 74-3.** *Aspergillus* species with septate hyphae that form V-shaped dichotomous branches.

with alcoholism, underlying lung disease, or chronic corticosteroid therapy.

**Aspergilloma:** It is a condition that occurs in a preexisting cavity in the lung parenchyma. This cavity may have been caused earlier by tuberculosis, sarcoidosis, cystic fibrosis, and emphysematous bullae. The condition is characterized by the presence of a ball of fungus within the cavity. The fungus, however, does not invade the cavity. It may cause hemoptysis.

**Invasive aspergillosis:** It is a rapidly progressive infection in patients who are severely immunocompromised. The condition is mostly fatal. In immunocompromised host, *Aspergillus* organisms cause a disseminated disease, leading to endophthalmitis, endocarditis, and abscesses in the viscera, such as liver, spleen, kidney, soft tissues, and bone.

## Epidemiology

Various clinical manifestations of *Aspergillus* infection have been documented worldwide. The incidence of allergic bronchopulmonary aspergillosis has been increasingly documented in people with asthma in United Kingdom. *Aspergillus* species unlike *Candida* species do not form the part of normal flora of humans. They are ubiquitous in the environment; hence transmission of infection is mostly exogenous.

## Laboratory Diagnosis

Laboratory diagnosis of invasive aspergillosis or chronic necrotizing aspergillus pneumonia depends on demonstration of *Aspergillus* in tissue by direct microscopy and culture.

### Key Points

- Direct KOH preparation of the specimen shows nonpigmented, septate hyphae with characteristic dichotomous branching at an angle of 45°. Biopsy specimens show septate, branching hyphae invading the tissues.
- The specimens are inoculated on SDA without cycloheximide and are incubated at 25°C for 1–2 days. Different *Aspergillus* species produce colonies of various colors. *A. fumigatus* produces grey colonies, whereas *A. niger* (Color Photo 67) and *A. flavus* (Color Photo 68) produce black and yellowish-green colonies, respectively. The isolation of *Aspergillus* by culture needs to be interpreted with care because they are common laboratory contaminants. Repeated isolation of the fungi may be of helpful to suggest the pathogenic role of the *Aspergillus*.
- Estimation of serum galactomannan is useful for diagnosis of invasive aspergillosis. Demonstration of elevated galactomannan in bronchoalveolar lavage is also useful for diagnosis of pulmonary aspergillosis.
- The diagnosis of allergic bronchopulmonary aspergillosis is established by a positive skin test for *A. fumigatus*. Highly increased level of serum IgE (>1000 IU/cc) and a positive serology for *Aspergillus* precipitation or *Aspergillus*-specific IgG or IgE antibodies are suggestive of the condition.
- Serum IgG levels are usually positive in aspergilloma.

## Treatment

Amphotericin B is most frequently used for treatment of invasive aspergillosis. However, the outcome of treatment is not satisfactory. Caspofungin is an alternative drug given to patients who do not respond to amphotericin B. Aspergilloma is treated best by removal of the fungus ball from the cavity by surgery.

## Prevention and Control

There are no specific preventive measures available against aspergillosis.

## Zygomycosis

Zygomycosis, also known as mucormycosis or phycomycosis, is an infection caused by saprophytic molds, such as *Mucor* (Fig. 74-4), *Rhizopus* (Fig. 74-5), and *Absidia*. These fungi are ubiquitous in the environment and generally saprophytic. They rarely cause disease in immunocompetent hosts, but they are the third most frequent cause of invasive fungal infection in immunocompromised patients.

*Rhizopus* species are the most common causative agents of zygomycosis in humans. Of many *Rhizopus* species, *Rhizopus arrhizus* is the most common agent of zygomycosis. The fungal

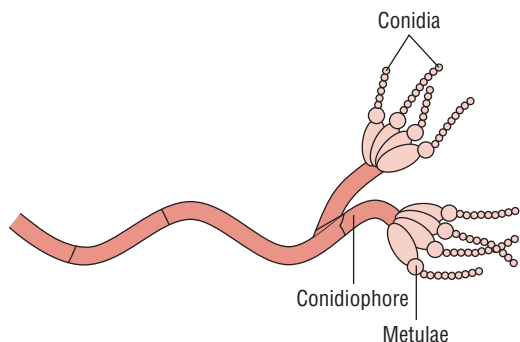

FIG. 74-4. *Mucor* species.

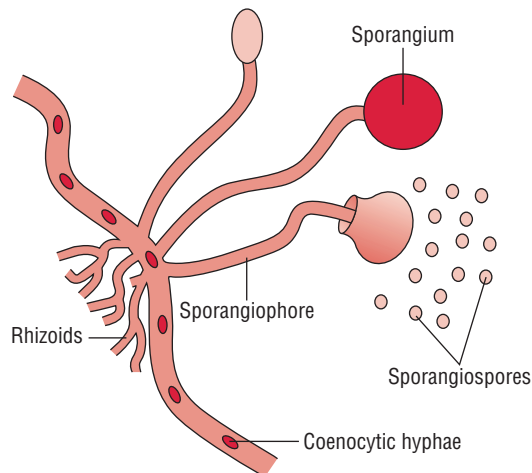

FIG. 74-5. *Rhizopus* species.

agents of zygomycosis have a high degree of predilection to invade major blood vessels, leading to ischemia, necrosis, and infarction of adjacent tissues. They are also known to affect patients with acidosis secondary to renal insufficiency, diarrhea, and aspirin intake. Most of the infections produced by Zygomycetes are acute and are usually fatal despite early diagnosis and treatment. The agents of zygomycosis are transmitted by air, through their asexual spores. In humans, they invade tissues of patients with reduced host defense. From there, they enter the blood vessels and proliferate in the walls of blood vessels particularly paranasal sinuses, lungs, or intestines. This results in infarction and necrosis of tissues distal to blocked vessels.

Zygomycetes cause a spectrum of diseases in humans depending on the immune status of the host and the portal of entry. These cause rhinocerebral zygomycosis, pulmonary zygomycosis, and gastrointestinal zygomycosis. Rhinocerebral zygomycosis is the most common manifestation of disease seen in patients with diabetic acidosis. Fever, unilateral facial pain or headache, nasal congestion, epistaxis, visual disturbance, and lethargy are the common manifestations.

Clinical diagnosis of the zygomycosis is frequently difficult. It requires a high degree of suspicion and a host with appropriate risk factors. Laboratory diagnosis is by microscopy, culture, and histopathology:

## Key Points

- It depends on demonstration of characteristic appearance of broad, nonseptate hyphae with right-angled branches in the specimen by microscopy. KOH mount of discharge scrapings may show broad, irregularly set hyphae with right-angled branches in case of rhinocerebral zygomycosis.
- Culture on SDA medium without antibiotics is dense and hairy. The LPCB preparation of the colony shows coenocytic nature of the hyphae and characteristic sporangia that contain sporangiophores. Fungal cultures are frequently negative. The fungi are difficult to culture because they are a single and very long cells and damage to any part of the cell prevents them to grow.
- Since culture often fails to show growth, histopathology of affected tissue is very useful to confirm the diagnosis. Fungal stain of biopsy material obtained from the affected tissue showing nonseptate hyphae with broad, irregular branches that form more or less at right angles confirms the diagnosis.
  - Blood cultures are of no value.
  - No serological tests are available.

Amphotericin B is the drug of choice for mucormycosis. Surgical removal of necrotic, infected tissues is frequently useful.

## Pneumocystosis

*Pneumocystis jiroveci*, previously known as *Pneumocystis carinii*, is the causative agent of *P. carinii* pneumonia (PCP). PCP is the most common opportunistic infection in HIV-infected patients.

## *Pneumocystis jiroveci*

*Pneumocystis* is a unicellular fungus found in the respiratory tracts of many mammals and humans. The genus *Pneumocystis* was initially mistaken for trypanosome, then later as a protozoan. Biochemical analysis of the nucleic acid composition of *Pneumocystis* rRNA and mitochondrial DNA in 1980s established it as a fungus. The cyst wall closely resembles that of fungi. However, it does not have ergosterol in its membrane as do the fungi, but instead has cholesterol.

### Properties

The organism has three distinct morphologic stages:

- The **trophozoite** or trophic form, where it often exists in clusters,
- The **sporozoite**, which is a precystic form, and
- The **cyst**, which contains several intracystic bodies known as spores.

### Pathogenesis and Immunity

Transmission of infection occurs by inhalation. Once inhaled, the trophic form of the organism attaches to the alveoli. Defects in both cellular immunity and humoral immunity allow for uncontrolled replication of the organism and development of the disease. Activated alveolar macrophages without CD4+ cells fail to eradicate the organism.

### Clinical Syndromes

*P. jiroveci* causes PCP in HIV patients with their CD4+ cells count below 200/ $\mu$ L. It also causes PCP in other patients with primary immune deficiencies including hypogammaglobulinemia and severe combined immunodeficiency, in organ (e.g., heart, lung, liver kidney)-transplant recipients' long-term immunosuppressive regimens, and in patients with hematologic and nonhematologic malignancies. Most cases of PCP are asymptomatic.

In symptomatic cases, sudden onset of fever, nonproductive cough, dyspnea, and tachypnea are typical manifestations. Bilateral rales and ronchi are present. Extrapulmonary manifestations are rare. It occurs in AIDS patients during their advanced stage.

### Epidemiology

*Pneumocystis* first came to attention when it was found to cause interstitial pneumonia in Central and Eastern Europe during World War II in severely malnourished and premature infants. Prior to 1981, there were only few reports (less than 100) from the United States. However, in 1981, CDC in the United States reported the occurrence of PCP in five healthy homosexual males residing in the Los Angeles. Now *P. jiroveci* is recognized

as one of the common causes of life-threatening opportunistic infections in patients with HIV infection worldwide.

Lungs of healthy individuals are the habitat of the fungus. Most children are believed to have been exposed to the organism by age 3 or 4 years.

PCP causes a mortality of 10–20% in patients with HIV depending on the stage of the disease. It also causes a considerable degree of mortality and morbidity in non-HIV patients.

In developing countries many of the cases are not being reported due to nonavailability of modern healthcare. *Pneumocystis* is found to be responsible for up to 80% of HIV-infected infants with pneumonia in Africa.

### Laboratory Diagnosis

Chest radiographs in most patients show diffuse bilateral infiltrates extending from the perihilar region. Patchy asymmetric infiltrates and pneumatoceles are less common finding.

#### Key Points

- Sputum induced by inhalation of a hypertonic saline solution is a useful specimen for microscopic demonstration of the organism. *Pneumocystis* is less frequently demonstrated in expectorated sputum. Bronchoalveolar lavage is the most common invasive procedure used to diagnose PCP. This is recommended when PCP is strongly suspected but induced sputum sample is repeatedly negative. It has a high sensitivity of more than 90%.
- Wright, Cresyl violet, and Giemsa stain detect both the trophozoite and cyst forms, but not the cyst wall. Methenamine silver, Gram-Weigert, and toluidine blue selectively stain the wall of *Pneumocystis* cysts. Papanicolaou smear is valuable to demonstrate a foamy-appearing eosinophilic material surrounding *Pneumocystis*. Direct immunofluorescence using monoclonal antibodies is a more sensitive method than histologic techniques for detection of *Pneumocystis* in histopathologic specimens.
- Open lung biopsy has 100% sensitivity and specificity because it provides the greatest amount of tissue for diagnosis. This is but an invasive procedure, hence reserved for rare cases when bronchoscopy is nondiagnostic.

### Treatment

*P. jiroveci*, although considered a fungus, does not respond to treatment with antifungal agents. A combination of trimethoprim and sulfamethoxazole is the drug of choice for treatment of PCP. Pentamidine and atovaquone are alternative drugs.

### Prevention and Control

Chemoprophylaxis with trimethoprim and sulfamethoxazole or aerosolized pentamidine is useful for prevention of infection in patients with CD4 counts below 200/ $\mu$ L.

## Penicilliosis

*Penicillium* species rarely cause opportunistic infections in humans. The *Penicillium* species are identified by their typical morphology (Fig. 74-6), culture characteristics on the SDA medium (Color Photo 69), and microscopy (Color Photo 70). *P. marneffeii* is the only dimorphic fungus in the genus *Penicillium* known to cause opportunistic infection.

## *Penicillium marneffeii*

*P. marneffeii* is the only dimorphic fungus in the genus *Penicillium*. It has been reported as an important opportunistic pathogen in AIDS patients. The fungus causes tuberculosis-like disease in patients with AIDS in Southeast Asian countries like Thailand. Few case reports have also been documented from India.

Capponi and colleagues (1956) first demonstrated *P. marneffeii* in liver of a bamboo rat. A laboratory-acquired case due to accidental inoculation of the skin was documented by Gabriel Segretian. Gabriel Segretian named the organism in honor of Hubert Marneffeii. First case of natural human infection was reported by DiSalvo and colleagues (1973) in an American minister with Hodgkin's disease.

### Key Points

The fungus, which is a dimorphic fungus, grows rapidly on SDA. At 25°C, it grows as a mold and produces greenish yellow colonies with dark green edge and pink or red center. It exhibits brick red pigment on the reverse. At 37°C, it grows as small yeast, producing cream-colored mucoid colonies resembling *Histoplasma capsulatum*.

Ability of the yeast forms to proliferate inside macrophages is the virulence characteristic of the fungus. The conidia attach to laminin, a glycoprotein in basement membrane, via sialic acid pathway and initiate the infection.

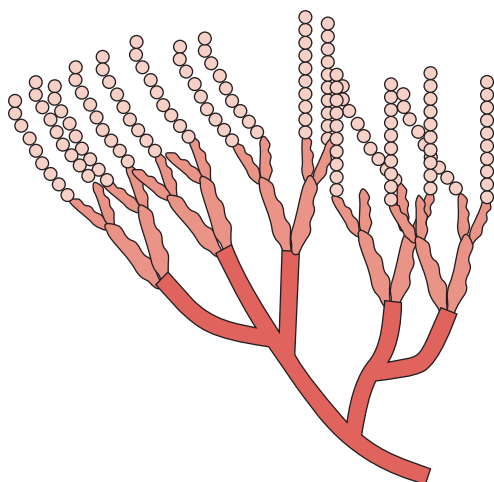

FIG. 74-6. *Penicillium* species.

Incubation period is variable from few weeks to years. *P. marneffeii* causes asymptomatic infections in immunocompetent hosts. It causes granulomatous or suppurative reaction, bronchopneumonia with or without adenopathy, and cavitory lung lesion. It produces chronic cervical lymphadenitis resembling tuberculosis. Disseminated infections occur rarely in immunocompetent hosts.

*P. marneffeii* causes disseminated infection in immunocompromised hosts, such as patients with HIV. It develops a necrotizing reaction and involves the skin, lung, and intestine. It causes disseminated infections of reticuloendothelial system, and also allergic diseases and mycotoxicoses. The disseminated infection is more common in adults than in children.

*P. marneffeii* is widely distributed in the nature. Its natural habitat is soil. The fungus infects no mammals other than humans and bamboo rat. Fungus is found in feces of rats and also in burrows made by the rats in the soil. The infection is transmitted by inhalation of conidia, direct inoculation of the skin, and rarely, by ingestion of infected rats. The condition is more common in rainy season, in rural areas.

Cell-mediated immunodeficiency, steroid treatment, and HIV infection are predisposing factors.

The fungus is endemic in Southeast Asian countries of Thailand, Vietnam, Laos, Myanmar, Singapore, and Indonesia. There has been recent increase in cases due to onset of AIDS pandemic. In India, 4 cases were reported by Singh and colleagues (1999) from eastern state of Manipur.

Laboratory diagnosis of the infection is made by microscopy, culture and serology:

### Key Points

- Demonstration of *P. marneffeii* in the skin and mucosal scrapings, sputum, stool, blood, urine, lymph node, bone marrow, lung and liver biopsy specimens. Staining of skin, lymph node, and bone marrow aspirate by hematoxylin and eosin, PAS (periodic acid-Schiff), Wright's, and calcofluor white stain demonstrates yeast cells with transverse septa.
- Immunohistochemical assay using monoclonal antibody against an external wall epitope is used to identify *P. marneffeii* in tissues. Demonstration of fungal antigen in affected tissue by using direct immunofluorescence antibody also helps in diagnosis of the condition. Peripheral blood smear shows *P. marneffeii* in patients with AIDS.
- Culture is the gold standard. *P. marneffeii* is a highly infectious fungus, hence culture should be done in a laboratory with a biohazard safety level-2 precautions. The fungus on SDA without cycloheximide and at 25°C produces mycelial grayish white colonies, green center, white periphery, and bright rose pigmented reverse (Color Photo 71). Microscopy of the colony shows septate hyaline hyphae, branched conidiophores, and three to five medullae which produce phialides that bear conidia in chains. The fungus on SDA at 37°C produces yeast-like colonies and cream-colored mucoid with brown red pigment. Microscopy of the colony shows pleomorphic ellipsoidal to rectangular yeast cells with transverse septum.
- Indirect immunofluorescent antibody test, immunoblot assay, and immunodiffusion method using mycelial phase culture antigen are used to demonstrate serum IgG antibodies. Immunodiffusion and latex agglutination tests are used to detect *P. marneffeii* antigen in serum and urine.

Treatment of the condition is carried out by administration of amphotericin B for 2 weeks followed by oral itraconazole for 10 weeks.

### ***Pseudoallescheria boydii* Infection**

*Pseudoallescheria boydii* is a mold that causes an opportunistic infection in immunocompromised persons, such as patients with HIV. It causes a disease, which clinically resembles aspergillosis. The diagnosis is made by demonstration of septate hyphae in tissue that resemble with those of *Aspergillus*. It can be differentiated from *Aspergillus* by culture on SDA medium. On culture, *P. boydii* produces pear-shaped conidia. The fungus causes cutaneous zygomycosis and disseminated zygomycosis. Ketoconazole and itraconazole are the drugs of

choice for treatment of *P. boydii* infection. Amphotericin B is not useful. Surgical removal of necrotic infected tissue is also useful.

### ***Fusarium solani* Infection**

*Fusarium solani* is a mold that causes disease primarily in neutropenic patients. It resembles *Aspergillus* in that it is a mold with aseptate hyphae, which tends to invade blood vessels. Fever associated with lesions in the skin is the common clinical presentation. The fungus differs from *Aspergillus* by culture in which it produces banana-shaped conidia. *F. solani* causes a disseminated disease primarily in neutropenic patients. Blood culture is frequently useful for diagnosis of the condition. Amphotericin B is the drug of choice.



#### CASE STUDY

A 32-year-old lady with AIDS was admitted to a hospital with fever and other nonspecific symptoms. Examination of her tongue revealed a white, thick patch. HIV serology was positive. Microscopy of the exudates collected from the patch showed Gram-positive *Candida*. Her CD4 count was 200/ $\mu$ L of blood.

- How will you confirm the species identification of *Candida*?
- What are the non-culture detection methods of *Candida*?
- Describe the pathogenesis of infection caused by *Candida* species.
- Describe treatment of the infection caused by *Candida*.

"This page intentionally left blank"



"This page intentionally left blank"

"This page intentionally left blank"

# Normal Microbial Flora

## Introduction

The term “normal microbial flora” denotes the population of microorganisms that inhabit the skin and mucous membrane of normal healthy individuals. It has been estimated that humans have approximately  $10^{13}$  cells in their body and about  $10^{14}$  bacteria are associated with them. The majority of bacteria are present in the large bowel, which constitutes the normal flora. The organisms are present in those parts of the body that are exposed to, or communicate with, the external environment, namely, the skin, nose, mouth, and intestinal and urogenital tracts. Internal organs and tissues are normally sterile.

The human fetus, in pregnant mother, lives in a sterile environment protected from microbes except when pathogens like cytomegalovirus, rubella virus, or *Toxoplasma gondii* cross the placenta for first 9 months of life. At the time of birth, the newborn is confronted with the mother’s vaginal microbes and environmental organisms. The infant’s skin surface is initially colonized followed by the oropharynx, gastrointestinal tract, and mucosal surfaces.

Microbes that have the ability to cause serious diseases are normally found in and on the human body. Not the recovery of specific organism, but the recovery of the organism in a normally sterile site is the hallmark of pathogenesis of microbial infections. For example, *Escherichia coli* is a normal resident confined to the gastrointestinal tract. If it is demonstrated in the stool, it may be considered normal, but if found in the abdominal cavity or the patient’s blood stream, this would be considered abnormal. Similarly, there are certain organisms that are never present as part of the normal microbial flora in humans; hence their recovery in humans is always associated with clinically significant diseases (e.g., *Bacillus anthracis*, *Brucella* spp., *Francisella tularensis*, and *Histoplasma capsulatum*, etc.).

Viruses and parasites are not considered as members of the normal microbial flora because they are not found as commensals in the host.

## Functions of Resident Flora

It should be appreciated that microbes serve a useful purpose in their human hosts. The normal microbiota maintains a protected environment that prevents colonization with potentially

pathogenic organisms. For example, *Clostridium difficile* produces gastrointestinal disease when the normal intestinal flora have been reduced or removed by antibiotics. The production of proteolytic enzymes by microbes augments host factors in the digestion of food. Intestinal bacteria can also synthesize vitamins and other biological products (e.g., biotin, pantothenic acid, pyridoxine, riboflavin, vitamin K, etc.). Colicins produced by some bacteria of normal flora prevent harmful effects of the bacteria.

The normal microbial flora is more or less constant for each mammalian species and is broadly divided into residents and transients. The interaction between microbes and humans can result in the following general outcomes: (a) disease, (b) transient colonization, and (c) prolonged colonization.

Disease results when the interaction between microbe and human host results in a pathological process. This process is mediated by microbial factors or by the host’s immune response to the presence of the organism. The other outcome of microbe and host interaction is colonization, either transient or prolonged.

Infection is another term used for colonization, which does not imply disease, but rather the association of the microbe with the human hosts for a time. The transient and prolonged colonization imply a distinction based on the duration of the interaction, which may extend to weeks, months, or years.

## Factors Determining the Colonization by Microbes

Factors that determine whether exposure to a microbe result in transient passage through a human host or prolonged colonization are complex and involve microbial properties, host characteristics, and environmental factors.

### Key Points

Colonization of skin is accomplished by organisms that:

- can tolerate the dry surface and
- are resistant to fatty acids produced by anaerobic bacteria and from the metabolism of sebum triglycerides.

The most important factors that determine colonization in human body are the properties of the specific organism. For

example, the oropharynx provides the organisms opportunities to colonize saliva, mucosal surface, tongue, and gingiva and teeth line. Thus oxygen-sensitive bacteria proliferate in the gingival crevices. *Streptococcus mutans* organisms adhere to the hard surface of teeth by polysaccharide. Bacteria can also bind to cells lining the oropharynx, intestine, and vagina via specific receptors for the bacterial pili. This type of adhesion prevents the mechanical elimination of organisms.

Various host factors determine the success of colonization with microbe. Nutritional and environmental conditions must favor the survival of microbes. The age of the host also influences microbial colonization. The hormonal secretions, alteration of dietary habits, person-to-person interaction, sexual activity, and many other factors determine the establishment of normal microbiota.

## Normal Flora at Various Sites of the Body

### Respiratory Tract

Respiratory tract is subdivided into (a) the upper airways, which include the anterior and posterior nares and the nasopharynx; (b) the middle airways comprising the oropharynx and tonsils; and (c) the lower airways with larynx, trachea, bronchi, and lungs. The structural and physiological differences at each site provide an environment compatible for some organisms and hostile for others.

#### ► Nares and nasopharynx

Nares are inhabited by a small number of organisms, which include *Staphylococcus*, *Corynebacterium*, *Peptostreptococcus*, and *Fusobacterium* species. The microbial population in the nasopharynx is more complex with the predominance of streptococci and *Neisseria* species. *Streptococcus salivarius*, *Streptococcus parasanguis*, and *Streptococcus pneumoniae* can be readily recovered from the nasopharynx. Twelve species of *Neisseria* have been recovered from nasopharyngeal carriers. Colonization with *Neisseria meningitidis* varies from 10% to 95% with the highest incidence in young adults. Other *Neisseria* species that colonize the nasopharynx are *Neisseria subflava*, *Neisseria sicca*, *Neisseria mucosa*, and *Neisseria lactamica*. Gram-negative coccobacilli that colonize the nasopharynx include *Moraxella catarrhalis* and *Kingella* species. Noncapsulated strains of *Haemophilus influenzae* are also commonly found in the nasopharynx.

#### ► Oropharynx and tonsils

The oropharynx is a complex mixture of ecosystems. Gram-positive and Gram-negative cocci predominate in the oropharynx. Overall, anaerobes outnumber aerobes with a ratio of 100:1. The most common anaerobic bacteria present in the oropharynx are *Peptostreptococcus*, *Veillonella*, *Actinomyces*,

and *Fusobacterium*, whereas the most common aerobic bacteria are *Streptococcus* and *Neisseria*. Nearly 20% of individuals are colonized with *Staphylococcus aureus*. *Streptococcus* species that colonize the oropharynx are *S. salivarius* (saliva), *Streptococcus sanguis* and *S. mutans* (tooth surface), *Streptococcus vestibularis* and *S. sanguis* (oral mucosa), *S. pneumoniae*, and beta-hemolytic streptococci. Other Gram-positive cocci that are present in the oropharynx include *Stomatococcus mucilaginosus*, *Gemella* species, etc.

Gram-negative cocci and coccobacilli also colonize the oropharynx. *Veillonella*, anaerobic Gram-negative cocci, are the most numerous Gram-negative cocci found in the oropharynx. Other Gram-negative cocci include *Neisseria*, *Moraxella*, *Kingella*, *Cardiobacterium*, and *Eikenella* species.

*Haemophilus* spp. are present in almost all individuals in less than 5% of the microbial population. Fifty percent of them are noncapsulated. *H. parainfluenzae* makes 10% of the bacterial flora in saliva. Members of the Enterobacteriaceae and nonfermentative Gram-negative bacilli are also present in the oropharynx in small numbers or transiently.

Gram-positive bacteria are also predominant microbes that constitute normal flora of the oropharynx. Actinomyces are present in large numbers, comprising 20% of bacterial flora in saliva and on the tongue, 35% in the gingival crevices, and 40% in the dental plaque. The ability of *Actinomyces* spp. to colonize various surfaces is mediated by the fimbriae and other extracellular polysaccharides present in the bacteria. Other Gram-positive bacilli present in the oropharynx are *Actinobacillus*, *Corynebacterium*, *Eubacterium*, *Lactobacillus*, *Propionibacterium*, and *Rothia* species.

The predominant anaerobes that are found in the oropharynx are *Fusobacterium*, *Bacteriodes*, *Porphyromonas*, *Prevotella*, and *Selenomonas* species. *Fusobacterium nucleatum* is the most common *Fusobacterium* found in the mouth.

Fungal colonization of the oropharynx is restricted to yeasts only; *Candida albicans* is present in almost all individuals. *Entamoeba gingivalis* and *Trichomonas tenax* are the only protozoa present in the oropharynx.

#### ► Trachea, larynx, bronchi, and lungs

Colonization of the lower airways is transient with few organisms present at any one time. Long-term colonization may occur when the ciliated epithelial cells are damaged or altered in a disease process.

### Gastrointestinal Tract

The gastrointestinal tract can be divided into various distinct anatomical areas. These include esophagus, stomach, jejunum and upper ileum, distal small intestine, and large intestine. The microbial flora present on the mucosa, within crypts, and in the lumen is different. Complete information has been obtained for the stomach and large intestine by studying the microbial composition of feces or the specimens collected during the intra-abdominal surgery.

## ► Esophagus

Sufficient information is not available about the microbial flora of the esophagus. However, transient colonization by oropharyngeal bacteria and yeasts is known to occur.

## ► Stomach

Stomach is an inhospitable organ containing hydrochloric acid and pepsinogen. For this reason, the normal microbial flora is very sparse. The organisms present in the stomach are acid-tolerant *Lactobacillus* spp., *Streptococcus* spp., and *Helicobacter pylori*. *H. pylori* causes gastritis and gastric and duodenal ulcers and is associated with gastric malignancy.

## ► Jejunum and upper ileum

The number of microbes in the upper part of the small intestine is less than  $10^5$ /mL of fluid. They are predominantly anaerobic, consisting of *Lactobacillus*, *Peptostreptococcus*, *Streptococcus*, *Porphyromonas*, and *Prevotella*. If upper tract obstruction and stasis occur, then the microbial flora shifts to resemble colonic bacteria, thereby leading to malabsorption syndrome.

## ► Distal small intestine

This is the transition area between the stomach (where a sparse number of acid-tolerant bacteria are found) and the large intestine (which is inhabited by a plethora of microbes). The microbial population is large ( $10^8$ – $10^9$  organisms/g of feces) and diverse with the predominance of anaerobes.

## ► Large intestine

This is the most densely populated organ in the human body. It consists of more than  $10^8$  aerobic bacteria and  $10^{11}$  anaerobic bacteria per gram of feces. Various yeasts and nonpathogenic parasites reside in this area. The bacteria in the large intestine that are present in large numbers include *Bifidobacterium* spp., *Bacteroides fragilis*, *Eubacterium* spp., *Enterococcus* spp., and *E. coli*. Although *B. fragilis* is the most virulent species, *Bacteroides thetaiotaomicron* is more numerous in the colon. *Eubacterium* spp. is the second most common bacterium in the large intestine. The most commonly isolated species are *Eubacterium aerofaciens*, *Eubacterium cylindroides*, *Eubacterium lentum*, and *Eubacterium rectale*. Nine species of *Bifidobacterium* have been isolated in feces. Among *Enterococcus* species, the most frequently isolated ones are *Enterococcus faecalis* and *Enterococcus faecium*.

*E. coli* causes colonization soon after an infant is born. It is the most common facultative organism responsible for intra-abdominal infections. Other members of *Enterobacteriaceae* like *Citrobacter* spp., *Klebsiella* spp., *Enterobacter* spp., and *Proteus* spp. can establish residence in the intestine.

*Streptococcus* species and *Actinomyces* have been isolated from fecal specimens. A variety of *Peptostreptococcus* and *Gemella* species are members of the normal intestinal flora. The spore-forming *Bacillus* species and *Clostridium* species are isolated from fecal specimens. *Vibrio parahaemolyticus* can also colonize the intestinal tract, but only in small numbers. Other

organisms commonly isolated in small numbers include species of *Fusobacterium*, *Porphyromonas*, and *Prevotella* species. Various species of *Candida* and protozoa colonize the large intestine.

## Genitourinary Tract

With the exception of female urethra and vagina, the genitourinary tract is generally sterile. The ureters, kidneys, prostate, and cervix are normally sterile. The female urethra is colonized with large number of lactobacilli, streptococcal species, and coagulase-negative staphylococci. Fecal organisms, such as *E. coli*, *Enterococcus* spp., and *Candida* spp. can also colonize the female urethra, which is transient.

The microbial flora in the vagina is more numerous and diverse. Lactobacilli are the predominant organisms with most commonly isolated species being *Lactobacillus acidophilus*, *Lactobacillus fermentum*, *Lactobacillus casei*, and *Lactobacillus cellobiosus*. Other anaerobes commonly isolated from the vagina are *Bifidobacterium*, *Peptostreptococcus*, *Porphyromonas*, and *Prevotella* species.

*Actinomyces* species are believed to be present in the vagina because they are associated with vaginal infections. *Actinomyces israeli* is the most common *Actinomyces* species associated with genital actinomycotic infections. *Propionibacterium* and *Mobiluncus* spp. are also present in the vagina.

The aerobic bacteria present in the vagina include coagulase-negative *Staphylococcus*, *Streptococcus* (viridans group and beta-hemolytic strains), *Corynebacterium* spp., *Gardnerella vaginalis*, *Neisseria* spp., *Haemophilus* spp., and members of *Enterobacteriaceae*.

Three species of nonpathogenic *Treponema* (*Treponema phagedenis*, *Treponema refringens*, and *Treponema minutum*) are found in vaginal specimens. Six species of *Mycoplasma* and *Ureaplasma* are common inhabitants of vagina, which have pathogenic potential.

The flagellate *Trichomonas vaginalis* is present in small numbers in healthy women. *Candida* species and *Torulopsis glabrata* are common members of the microbial flora of vagina.

## Body Surface

Human skin is constantly bombarded by organisms present in the environment. The skin is exposed to extremes of temperature, moisture, and to chemical disinfectants. There the microbial population is less numerous and complex than at other body sites. The skin is not a homogenous surface. There are relatively dry areas like palms and soles; areas with more apocrine glands, such as axillary, inguinal, and perianal areas; and areas rich with sebaceous glands like forehead and nasolabial folds. Most organisms proliferate in the moist area. Thus higher densities of microbes are present in areas rich with sweat glands. The skin of face, perirectal area, or groin has a more complex microbial flora than that at other sites (Fig. 75-1).

Anaerobic bacteria are 10- to 100-fold more numerous on the skin surface as compared to aerobic bacteria. Gram-positive bacteria predominate over Gram-negative bacteria. The bacteria more commonly recovered from skin surfaces are *Staphylococcus* spp., *Micrococcus* spp., *Corynebacterium* spp.,

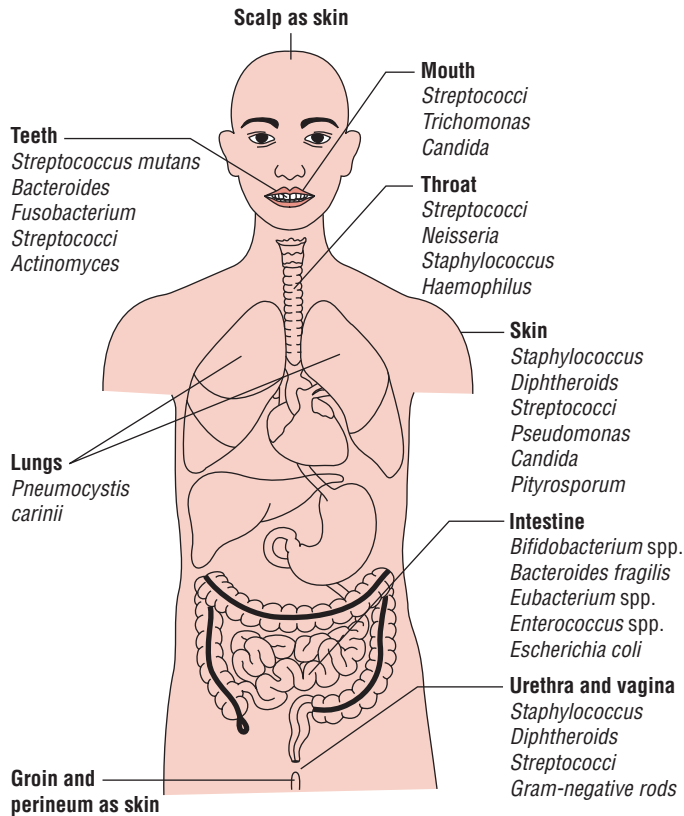

FIG. 75-1. Sites of microbial flora.

*Peptostreptococcus*, and *Propionibacterium* spp. *Staphylococcus epidermidis* is the most commonly isolated bacterium. Other coagulase-negative staphylococci found on the skin include *Staphylococcus hominis*, *Staphylococcus haemolyticus*, *Staphylococcus warneri*, and *Staphylococcus capitis*. *Micrococcus luteus* is the most common *Micrococcus* spp. present on the skin and represents 20% of the bacterial population on the head, legs, and arms. *Aerococcus viridans*, *Streptococcus pyogenes*, and anaerobic *Peptostreptococcus* spp. also establish residence on the skin surface. *Corynebacterium* species present on the skin surface include *Corynebacterium xerosis*, *Corynebacterium jeikeium*, and *Corynebacterium minutissimum*. The anaerobic Gram-positive bacilli present on the skin surface are *Propionibacterium* spp. and *Clostridium perfringens*.

Gram-negative bacteria are generally not recovered from the surface of skin, except during transient colonization.

*Acinetobacter* spp. organisms have adapted to survive in moist areas of the skin.

Fungal colonization of the skin surface is transient. This includes colonization with yeasts (*C. albicans*, *Malassezia furfur*, and *Rhodotorula*) and dermatophytes. Among these, *M. furfur* is present in most of the individuals.

## Conjunctiva

The flushing action of tears and presence of lysozymes in the tears usually make the conjunctiva free of bacteria. The organisms that may be present in the conjunctiva are *C. xerosis*, *Moraxella* spp., *S. aureus*, and nonhemolytic streptococci.

## Sterile Sites

The body fluids which include blood, cerebrospinal fluid, synovial, pleural, pericardial, peritoneal, and other exudates are normally sterile or transiently infected by microbes.

Some microbes from the mouth and gastrointestinal tract can invade the blood stream in healthy individuals (during tooth brushing or a bowel movement). These organisms are rapidly removed and are of little significance. Thus, the isolation of an organism from body fluids should be considered significant unless the specimen is contaminated during its collection.

Organ tissues are also generally sterile unless they are infected following systemic spread. Some bacteria like *Mycobacterium tuberculosis* may be disseminated to lungs, liver, and kidney during initial infection and remain dormant. In this situation, the organism can be recovered from tissue samples. Long-term colonization with organisms like *Pneumocystis carinii* or latent viruses, such as herpes simplex virus or cytomegalovirus may commonly occur. The external auditory meatus, being an extension of the skin, is colonized primarily by *S. epidermidis* and diphtheroids.

Human body serves as a home for numerous microbes qualitatively and quantitatively. They cover the skin and mucosal surfaces; occasionally, they invade into sterile sites to produce disease. These microorganisms act as a barrier to more virulent microorganisms, provide vitamins and required growth factors, or exist as commensal inhabitants. The complexity of the microbiota is influenced over time by environmental, host, and microbial factors. Thus, the knowledge of the human microbiota forms a fundamental building block of the normal physiological processes in the human body.

# Bacteriology of Water, Milk, and Air

## Introduction

Drinking water or potable water, ideally, should not only be safe but also pleasant to drink. It should be clear, colorless, and devoid of disagreeable taste or smell. It should be free from pathogenic microorganisms and chemical substances.

Similarly, milk is usually sterile at secretion in the udder but is contaminated by bacteria even before it leaves the udder. Except in the case of mastitis, the bacteria at this point are harmless and few in number. Further infection of the milk by microorganisms can take place during milking, handling, storage, and other preprocessing activities.

Innumerable microorganisms are present all over in air in the environment. Apart from bacteria, molds and viruses are also present and can be transmitted from person to person in the form of aerosols. The proportion of the dust particles or aerosols reaching the lung depends on their size. All particles over 5  $\mu\text{m}$  are retained in the nose and those of 1  $\mu\text{m}$  reach the lung and are retained in the alveoli.

Bacterial analysis of water, milk and air is therefore carried out to indicate quality of these items used in day-to-day life.

## Bacteriology of Water

Water is said to be contaminated or polluted when it is contaminated with sewage or other excreted matter from humans and animals that contains infective and parasitic agents, poisonous chemical substances, and industrial or other wastes.

### Bacterial Flora in Water

Bacterial flora in water (Table 76-1) can be classified into three groups as follows:

**Natural water bacteria:** These are the bacteria that are commonly found in water free from gross pollution.

**Soil bacteria:** These are the bacteria that are not normal inhabitants of water but are found after being washed into the water during heavy rains.

**Sewage bacteria:** These are the bacteria that are not normal inhabitants of water but are found in water after being contaminated with sewage. These bacteria include those which are the normal inhabitants of the intestine of humans and animals. These also include the bacteria that live mainly on decomposed organic matter of either plant or animal origin.

### Factors Determining the Number of Bacteria in Water

The following factors determine the number of bacteria in water:

**Salinity:** The number of bacteria present in water depends on salinity of water; more is the salinity, lesser is the number of bacteria. However, some halophilic bacteria survive better in saline water.

**Acidity:** Acidity of water has a deleterious effect on most of the bacteria.

**Temperature:** Low temperature usually favors survival of the bacteria. However, in the presence of organic materials, bacteria tend to multiply even at high temperature.

**Light:** Sunlight with the wavelength of 300–400 nm is highly bactericidal, provided water is clear and static. The bactericidal effect is reduced due to the presence of organic matter and due to movement in water.

**Storage:** Storage of water decreases bacterial count in stored water due to sedimentation and revitalization.

**Organic matter:** When organic matter is plenty, the microorganisms tend to multiply and are present in large numbers whereas when it is less, the organisms are few.

**Type of water:** Surface water is more likely to be contaminated than the deep water. The latter is usually pure.

TABLE 76-1

Bacterial flora in water

Source of water	Bacteria
Natural water bacteria	<i>Micrococcus</i> , <i>Pseudomonas</i> , <i>Acinetobacter</i> , <i>Serratia</i> , <i>Alcaligenes</i> , and <i>Flavobacterium</i>
Soil bacteria washed into water	<i>Bacillus subtilis</i> , <i>Enterobacter cloacae</i> , and <i>Enterobacter aerogenes</i>
<b>Sewage bacteria:</b>	
Proper sewage bacteria	<i>Clostridium perfringens</i> , <i>Proteus</i> species
Intestinal flora through sewage	<i>Escherichia coli</i> , <i>Enterococcus faecalis</i> , <i>Proteus</i> species, <i>Klebsiella</i> species, <i>Clostridium perfringens</i>

TABLE 76-2

## Water-borne pathogens

<b>Bacteria</b>	<i>Vibrio cholerae</i> ; <i>Salmonella</i> Typhi, <i>Salmonella</i> Paratyphi A, B, and C; <i>Shigella</i> spp.; <i>Escherichia coli</i> ; <i>Yersinia enterocolitica</i> ; and <i>Campylobacter jejuni</i>
<b>Viruses</b>	Hepatitis A virus, Hepatitis E virus, poliomyelitis virus, rotavirus, and Norwalk virus
<b>Protozoa</b>	<i>Entamoeba histolytica</i> , <i>Giardia lamblia</i> , <i>Cryptosporidium</i> spp., <i>Cyclospora</i> spp., <i>Isospora</i> spp., and <i>Balantidium coli</i>
<b>Helminthes</b>	<i>Ascaris lumbricoides</i> , <i>Trichuris trichiura</i> , and <i>Enterobius vermicularis</i>

## Water-Borne Microorganisms

Supply of drinking water is contaminated with sewage or other excreted matter from humans and animals; it can transmit a wide number of pathogens that includes bacteria, viruses, and parasites (Table 76-2).

## Bacteriological Examination of Water

Since a wide number of pathogens can be transmitted by contaminated water, it is essential to know whether water is free of such pathogens or not. Hence, the main purpose of water testing is to know whether the water is contaminated by water-borne pathogen or not. Therefore, in the interests of public health, water supplies should be tested regularly to confirm their freedom from such contamination.

It is impracticable to make an attempt to detect all types of water-borne pathogens, any of which may be present only intermittently. Instead attempt is made on testing the water for microorganisms that indicate fecal contamination of water. These are known as indicator organisms. These are usually common intestinal commensal bacteria, which are universally present in and excreted in large numbers in human and animal feces. They are rarely found in other sources.

### ▶ Indicator organisms

The presence of indicator organisms indicates that:

- fecal matter has entered the water supply,
- the fecal bacteria have not been killed or removed by purification processes, and
- the water supply, therefore, is liable to be contaminated with dangerous intestinal pathogens.

## Key Points

The indicator organism should have the following properties:

- It should be present in human feces in large numbers;
- It should not multiply in water to any extent; and
- It should be more resistant than pathogens to the stresses of the aquatic environment and disinfection processes, such as the process of chlorination.

Some of the organisms that are used as indicator organisms are as follows:

**Coliforms:** These are the bacteria that occur in large numbers in sewage and feces. They are also found in the environment

in the absence of fecal contamination. Traditionally, these are members of the Enterobacteriaceae, which grow in the presence of bile salts and produce acid and gas from lactose within 48 hours at 37°C. The total coliform count is widely regarded as the most reliable indicator of potable water quality.

**Fecal streptococci:** These bacteria are found in the intestinal tract of humans and animals. They belong to the genus *Enterococcus*, and are catalase-negative and Gram-positive cocci. They can survive at 60°C for 30 minutes, and can grow at a pH of 9.6 and in the presence of 6.5% sodium chloride.

**Sulfite-reducing clostridia:** These are members of the genus *Clostridium*, which can reduce sulfite to sulfide. The most important of the group is *Clostridium perfringens*. Although it is less numerous in human feces than other indicator organisms, its spores can survive in the environment and treatment processes better than most of other indicator bacteria.

### ▶ Collection of water samples for analysis

Water samples should be collected in heat-sterilized bottles of 250 mL capacity with ground glass stoppers. A 0.23 mL of fresh 1.8% solution of sodium thiosulfate crystal is added into the bottle before sterilization, to neutralize the bactericidal effect of any chlorine or chloramine in the water.

**Sampling from a tap or pump outlet:** When collecting from taps, allow the water to run to waste for 2–3 minutes before running it into the bottle. Then the stopper of the bottle is opened, it is filled with water, and the stopper is replaced.

**Sampling from a reservoir, such as stream, river, lakes, and tanks:** When sampling from streams or lakes, the bottle is opened at a depth of about 30 cm with its mouth facing the current and it is ensured that the water entering the bottle has not been in contact with hands.

**Sampling from a well:** The sampling bottle is tied with a stone and a clean cord of suitable length and is lowered to the required depth in the well. The bottle is completely immersed in the water. When the bottle is completely filled, it is pulled out and then it is stoppered. It is ensured that the bottle does not touch the side of the well at any time. The bottle, after collection of water, is wrapped by a Kraft paper and is labeled with following details: the source, time, and date of collection of water samples. The bottle is transported immediately preferably within 6 hours of collection in a cool container being protected from the sunlight.



## ► Methods of water analysis

Following tests are generally done for the routine bacteriological analysis of water:

1. Presumptive coliform count
2. Differential coliform count
3. Membrane filtration method
4. Detection of fecal streptococci and *C. perfringens*
5. Detection of specific pathogens

**Presumptive coliform count:** The test is called presumptive coliform count because the reaction demonstrated may occasionally be due to the presence of some other microorganisms. This is a multiple tube method in which measured volumes of water and dilutions of water are added to a series of tubes or bottles containing a liquid indicator medium. The most common medium used is double-strength and single-strength MacConkey broth containing bromocresol purple and an inverted Durham's tube to detect the production of gas.

The measured volume of water to be tested is added by sterile graduated pipettes to tubes or McCartney bottles as follows: (a) 50 mL of water is added to one bottle of 50 mL double-strength medium, (b) 10 mL of water each to five bottles of 10 mL double-strength medium, (c) 1 mL of water each to five tubes of 5 mL single-strength medium, and (d) 0.1 mL of water each to five tubes of 5 mL single-strength medium.

The inoculated bottles are incubated at 37°C for 48 hours. The presumptive coliform count/100 mL of water is determined by demonstration of acid and gas in MacConkey broth using the McCrady probability Table 76-3. The water sample showing a presumptive coliform count of 0 is considered as excellent, whereas water samples showing coliform counts of 1–3, 4–10, and more than 10/mL are considered as satisfactory, suspicious, and unsatisfactory, respectively.

**Differential coliform count:** Differential coliform count is carried out by Eijkman test. Some spore-bearing bacteria give false-positive reactions in the presumptive coliform test. The Eijkman test is used to determine whether the coliform bacilli detected in the presumptive test are *Escherichia coli* or not. The test is carried out after the usual presumptive test and is performed by inoculating subcultures from the positive presumptive tests at 44°C and 37°C into fresh tubes of single-strength MacConkey broth with Durham's tube. Those tubes showing gas in Durham's tube after incubation at 44°C after 24 hours indicate the presence of *E. coli*. Confirmation of *E. coli* is made by subculturing on the solid media and testing the color for indole production and citrate utilization (Fig. 76-1).

**Detection of fecal streptococci:** Detection of fecal streptococci in water sample also indicates fecal contamination of water.

The test is carried out after the usual presumptive test and is performed by incubating subcultures from the positive presumptive tests at 44°C and 37°C into fresh tubes. It is incubated at 45°C for 18 hours. The presence of acid in the medium

TABLE 76-3

McCrady probability table

Quantity of water	50 mL	10 mL	1 mL	Probable no. of coliform bacilli in 100 mL water
No. of samples of each quantity tested	1	5	5	
Number giving positive reaction (acid and gas)	0	0	0	<1
	0	0	1	1
	0	0	2	2
	0	1	0	1
	0	1	1	2
	0	1	2	3
	0	2	0	2
	0	2	1	3
	0	2	2	4
	0	3	0	3
	0	4	0	5
	1	0	0	1
	1	0	1	3
	1	0	2	4
	1	0	3	6
	1	1	0	3
	1	1	1	5
	1	1	2	7
	1	1	3	9
	1	2	0	5
	1	2	1	7
	1	2	2	10
	1	2	3	12
	1	3	0	8
	1	3	1	11
	1	3	2	14
	1	3	3	18
	1	3	4	21
	1	4	0	13
	1	4	1	17
	1	4	2	22
	1	4	3	28
	1	4	4	35
	1	4	5	43
	1	5	0	24
	1	5	1	35
	1	5	2	54
	1	5	3	92
	1	5	4	161
	1	5	5	180+

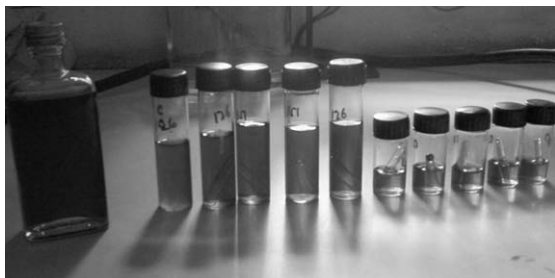

FIG. 76-1. Eijkman test.

indicates the presence of *Enterococcus faecalis*. Further confirmation of *E. faecalis* is made by subculturing on the MacConkey medium.

**Detection of *C. perfringens*:** It is detected in water samples by inoculating it in litmus milk medium and incubating it anaerobically at 37°C for 5 days. A typical stormy clot reaction along with formation of acid indicates the presence of *C. perfringens*. Further confirmation of the bacteria is made by motility and nitrate reduction test.

**Membrane filtration method:** In this method, a measured volume of the water sample is filtered through a membrane with a pore size small enough to retain the indicator bacteria to be counted. The membrane is then placed and incubated on a selective indicator medium, so that the indicator bacteria grow to produce colonies. These colonies are then identified and counted to give a measure of the contamination of the water.

**Detection of specific pathogens:** *Vibrio cholerae*, *Salmonella Typhi*, etc. are the specific pathogens, which can be detected in water sample to know the contamination. Specific selective media for these bacteria are employed to detect these in contaminated water. For example, double-strength selenite F broth is used for *S. Typhi*, whereas alkaline peptone water is used for *V. cholerae*. Subsequently, these bacteria are identified by their cultural and biochemical characteristics.

## Bacteriology of Milk

Milk is an opaque white liquid, which provides the primary source of nutrition for newborns before they are able to digest other types of food. It is an emulsion of butterfat globules within a water-based fluid. Each fat globule is surrounded by a membrane, consisting of phospholipids and proteins. These emulsifiers keep the individual globules from joining together into noticeable grains of butterfat and also protect the globules from the fat-digesting activity of enzymes found in the fluid portion of the milk.

## Bacterial Flora of Milk

**Lactic acid bacteria:** This group of bacteria is able to ferment lactose to lactic acid. They are normally present in the milk and are also used as starter cultures in the production of cultured

dairy products, such as yogurt. Some examples of lactobacilli found in milk are:

1. Lactococci, such as *Lactic delbrueckii* subsp. *lactis* (*Streptococcus lactis*) and *Lactococcus lactis* subsp. *cremoris* (*Streptococcus cremoris*).
2. Lactobacilli, such as *Lactobacillus casei*, *Lactobacillus delbrueckii* subsp. *lactis* (*L. lactis*), *Lactobacillus delbrueckii* subsp. *bulgaricus* (*Lactobacillus bulgaricus*), and *Leuconostoc*.

**Coliforms:** Coliforms are facultative anaerobes with an optimum growth at 37°C. Coliforms are indicator organisms; they are closely associated with the presence of pathogens but are not necessarily pathogenic themselves. They also can cause rapid spoilage of milk because they are able to ferment lactose with the production of acid and gas, and are able to degrade milk proteins. They are killed by pasteurization; therefore, their presence after treatment is indicative of contamination. *E. coli* is an example belonging to this group.

## Significance of Presence of Microorganisms in Milk

Information on the microbial content of milk can be used to judge its sanitary quality and the conditions of production. If permitted to multiply, bacteria in milk can cause spoilage of the product. Milk is potentially susceptible to contamination with pathogenic microorganisms. Precautions must be taken, therefore, to minimize this possibility and to destroy pathogens that may gain entrance. Certain microorganisms produce chemical changes that are desirable in the production of dairy products, such as cheese and yogurt.

## Spoilage Microorganisms in Milk

The microbial quality of raw milk is crucial for the production of quality dairy foods. **Spoilage** is a term used to describe the deterioration of a foods' texture, color, odor, or flavor to the point where it is unappetizing or unsuitable for human consumption. Microbial spoilage of food often involves the degradation of protein, carbohydrates, and fats by the microorganisms or their enzymes.

In milk, the microorganisms that are principally involved in spoilage are psychrotrophic organisms. Most psychrotrophs are destroyed by pasteurization temperatures; however, some like *Pseudomonas fluorescens*, *Pseudomonas fragi* can produce proteolytic and lipolytic extracellular enzymes, which are heat stable and capable of causing spoilage. Some species and strains of *Bacillus*, *Clostridium*, *Corynebacterium*, *Arthrobacter*, *Lactobacillus*, *Microbacterium*, *Micrococcus*, and *Streptococcus* species can survive pasteurization and grow at refrigeration temperatures, which can cause spoilage problems.

## Pathogenic Microorganisms in Milk

Hygienic milk production practices, proper handling and storage of milk, and mandatory pasteurization have decreased

the threat of milk-borne diseases, such as tuberculosis, brucellosis, and typhoid fever. There have been a number of food-borne illnesses resulting from the ingestion of raw milk or dairy products made with milk that was not properly pasteurized or was poorly handled, causing postprocessing contamination. Milk-borne diseases are of three types:

- Infections primarily of humans but transmitted through milk.
- Infections primarily of animals that can be transmitted to humans.
- Infections transmitted by milk contaminated with excreta of ticks and rats (Table 76-4).

It should also be noted that molds, mainly of the species of *Aspergillus*, *Fusarium*, and *Penicillium* can grow in milk and dairy products. If the conditions permit, these molds may produce mycotoxins, which can be a health hazard.

## Bacteriological Examination of Milk

Bacteriological examination of milk can be carried out by following groups of tests:

1. Colony counts
2. Coliform counts
3. Chemical tests, such as methylene blue reduction test, phosphatase test, and turbidity test
4. Detection of specific pathogens

### ► Colony counts

This test is carried out by plate dilution methods. Raw milk may contain 500 to several million bacteria/mL of milk.

### ► Coliform counts

The presence of coliforms in milk indicates improper pasteurization of milk, or postpasteurization contamination of milk. This is because all coliforms are destroyed during the process of pasteurization of milk. This test is carried out by inoculating varying dilutions of milk into MacConkey medium and noting the production of acid and gas after 48 hours of incubation at 37°C. The presence of acid and gas indicates the presence of coliforms in milk.

### ► Chemical tests

**Methylene blue test:** This is a test used since long to demonstrate bacterial contamination of milk. It is an indicator of the number of viable bacteria present in the milk. It is a rapid and inexpensive way of indicating poor-quality milk that had been

unrefrigerated. The basis of the test is that the presence of viable bacteria in milk reduces methylene blue and decolorizes the milk when kept in a dark place. The test is performed by using a 1:300,000 solution of methylene blue. One milliliter of the methylene blue solution is added to 10 mL of the milk sample in a test tube. Both the milk and methylene blue solution are mixed by shaking and then placing the mixture in a water bath at 37°C for 30 minutes in dark. Untreated milk can be considered as satisfactory if it fails to decolorize the dye within 30 minutes.

**Phosphatase test:** Alkaline phosphatase is normally present in milk and is inactivated if pasteurization has been carried out effectively. Successful pasteurization, which kills nonsporing pathogens, also inactivates alkaline phosphatase. The test depends on the ability of the enzyme to liberate *p*-nitrophenyl phosphate after breaking down disodium *p*-nitrophenyl phosphate. The test determines the amount of alkaline phosphatase present after pasteurization by measuring the amount of *p*-nitrophenyl phosphate it liberates, which is known by development of a yellow color that is quantitated by a colorimeter.

**Turbidity test:** This is the definitive test for checking the sterilization of milk, thereby distinguishing it from the untreated milk and milk that has been merely pasteurized. The degree of heating necessary for sterilization causes all the heat-coagulable proteins in milk to become precipitable by ammonium sulfate. If the amount of heat applied to milk is insufficient for sterilization, some of its protein will not be precipitated by ammonium sulfate and will be detected by its coagulation, resulting in turbidity when a filtrate of ammonium sulfate treated-milk is boiled. The absence of turbidity indicates that the milk has been boiled or heated to at least 100°C for at least 5 min.

### ► Detection of specific pathogens

*Mycobacterium tuberculosis* and *Brucella* species are the specific pathogens that can be detected in milk to know transmission of these bacteria through milk. Specific selective media for these bacteria are employed to detect these in infected milk. For example, *M. tuberculosis* can be isolated from centrifuged deposit of milk by inoculation in Lowenstein-Jensen (LJ) medium or by inoculation in guinea pigs. Similarly, *Brucella* spp. may be isolated from milk samples by inoculating in serum dextrose agar or by intramuscular inoculation in guinea pigs. Subsequently, these bacteria are identified by their cultural and biochemical properties. *Brucella* spp. in infected animals can also be demonstrated by milk ring test, whey agglutination test, and demonstration of brucella antibodies in serum.

TABLE 76-4

Milk-borne diseases

Source	Diseases
Primarily of humans	Enteric fever, cholera, bovine tuberculosis, shigellosis, and staphylococcal food poisoning
Primarily of animals	Tuberculosis, brucellosis, salmonellosis, cowpox, <i>Campylobacter fetus</i> infection, and <i>Yersinia enterocolitica</i> infection
Contamination of milk by ticks and rats	Tick-borne encephalitis and <i>Streptobacillus moniliformis</i> infection

## Bacteriology of Air

The load of microorganisms present in the air depends on whether the air is indoors or outdoors. The number of bacteria at any time is dependent on many factors, the most important of which are the number of persons present, the amount of their body movements, and the amount of disturbance of their clothing.

### Bacteriological Examination of Air

Observations of the number of bacteria carrying particles in the air may be required in premises where safe working depends on the air's content of bacteria being kept at a very low level, e.g., operation theaters. Bacteriological examination of air is also necessary for monitoring air quality in hospital wards, store house of food and pharmacy, etc.

Ideally, bacterial count should not exceed 1 per cubic foot of air in operation theater for neurosurgery, 10 per cubic foot in operation theater for other surgery, and 50 per cubic foot in homes, offices, and factories.

Various methods have been devised for the measurement of bacterial content of air. A primary distinction must be drawn between the methods that measure the rate at which bacteria carrying particles are settling by gravity on to exposed surfaces and those that count the number of bacteria carrying particles

in a given volume of the air. Two types of methods used for bacteriological examination of air are as follows:

1. Settle plate method
2. Slit sampler method

#### ▶ Settle plate method

Settle plate method is used for testing bacteriological quality of air in surgical operation theaters and hospital wards. In this method, Petri dishes containing nutrient agar and blood agar (for detecting pathogenic staphylococci and streptococci) are left open for half an hour to one hour. During this period of exposure, large bacteria carrying dust particles settle on to the media. The plates are then incubated at 37°C for 24 hours, following which the colonies formed on the media are counted.

#### ▶ Slit sampler method

Slit sampler method is most efficient and convenient method used for estimation of the number of bacteria present in a measured volume of air. In this method, one cubic foot volume of air is directed onto a plate containing culture medium through a slit 0.25-mm wide. The plate is then rotated so as to allow the microorganisms present in the air to spread out evenly on the medium. The culture medium is incubated and the number of colonies formed on the medium indicates the number of bacteria present in the air.

# Nosocomial Infections

## Introduction

The term hospital infection, hospital-acquired infection, or nosocomial infection is applied to infections occurring in hospitalized patients who were neither infected nor were in incubation at the time of their admission to the hospital.

Approximately, 5% of hospitalized patients experience a nosocomial infection. Nosocomial infection represents an important public health problem in developing countries, as in developed ones today, and as a major cause of high morbidity, mortality, and economic consequences in hospitalized patients.

The impact of hospital-acquired infections is considerable—the patient may need longer hospital treatment, readmission, or even further surgery, increasing the time of absence from work and use of hospital and community resources. The recent trend of shorter hospital stays means that more patients with hospital-acquired infections are presenting to general practitioners in the community. In addition, as home administration of intravenous medications becomes increasingly common, cannula-associated infections, once confined to hospital patients, may present in the community.

## Factors Affecting Hospital-Acquired Infection

Hospital infections as a group differ from other community-acquired infections, both in their patient profile and the severity and treatment of the disease caused by them. The factors influencing hospital-acquired infections are as follows:

**Hospitalized patients:** Susceptible hospitalized patients are one of many factors responsible for hospital-acquired infections. This is because most patients admitted in wards have impaired immunity either as a part of their preexisting disease processes or, in some instances, due to the treatment they have received in the hospital. They are therefore highly susceptible to infection.

**Hospital environment:** The hospital environment harbors a higher load of microorganisms due to the multitudes of infected patients visiting the hospital. These organisms manage to infect the susceptible hosts through the medium of fomites in certain cases and through human carriers in others. Contamination of food, water, and in a few cases air has also been implicated in outbreaks of hospital infections.

**Antibiotics resistance:** The infectious agents present in the hospital environment also possess the dubious distinction of being more difficult to treat as they are usually resistant to a range of drugs which are used commonly. The initial resistant strains of bacteria are present in large numbers due to the constant selection pressure exerted because of the necessary antibiotic usage inside the hospitals and these then spread, replacing the other strains in the hospital.

**Diagnostic or therapeutic procedures:** Diagnostic or therapeutic interventions, such as insertion of intravenous or urethral catheters, may introduce infection to susceptible patients and cause iatrogenic infections. There is a good chance that hospital infections are caused by the patient's own flora as many invasive procedures are carried out within the hospitals, which exposes them to this risk.

**Transfusion:** Transfusion of blood, blood products, and intravenous fluids, if not properly screened, may transmit blood-borne pathogens to the recipient hospitalized patients.

## Epidemiology of Hospital-Acquired Infection

### Sources of Infections

The sources of hospital-acquired infection may be exogenous or endogenous. *Exogenous infection* is most important and occurs mostly from (i) another patient, (ii) a member of the medical and paramedical staff harboring the pathogens, or (iii) from the environment. The latter includes inanimate objects, such as medical equipments (e.g., catheters, endoscopes, cystoscopes, etc.), bed pans, and surfaces contaminated by the patient's secretions, excretions, blood, and other body fluids. It also includes hospital food, water, and environmental air (Fig. 77-1).

*Endogenous infection* is due to microbes present in the patient's own flora present in the body. Microorganisms from these floras may cause infections in different tissues of the patient during certain surgical operations, manipulation by instruments, or nursing procedures.

### Microorganisms Causing Infections

Though initially much of the hospital outbreaks were caused by Gram-positive organisms like *Streptococcus pyogenes* and methicillin-resistant *Staphylococcus aureus* (MRSA), presently Gram-negative enteric pathogens including *Escherichia coli*,

*Klebsiella*, *Enterobacter* species, etc., have emerged as an important cause of these infections.

*Pseudomonas* and *Acinetobacter* species are also common nosocomial pathogens, because they can survive as saprophytes in the environment and are extremely hardy, developing resistance to most of the commonly used antibiotics, and in some cases managing to grow even inside bottles of disinfectant solutions.

## Key Points

The new and emerging pathogens have several features in common:

- They survive for a long period in the hospital environment.
- They are resistant to commonly used antibiotics and disinfectants.
- They cause both endemic and epidemic hospital outbreaks, resulting in significant patient morbidity and mortality.

The microorganisms causing hospital-acquired infection are listed in Table 77-1.

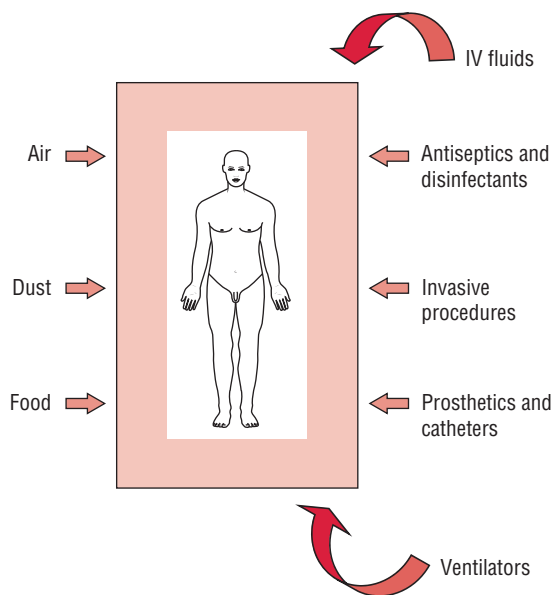

FIG. 77-1. Environmental sources of nosocomial infections.

There is also concern that these organisms may spread from hospitals into the general community—as evidence suggests that MRSA has done—especially into long-term care facilities, such as nursing homes, thereby causing a more serious health problem in the community.

## Transmission of Infections

Many organisms gain entry to the body through breaches or evasion of “first line” body defenses. Breaches in epithelial integrity (e.g., surgical wounds, intravascular cannulas, and drain tubes), loss of the washing action of body fluids (e.g., because of a urinary catheter), and interference with first-line respiratory defenses (e.g., by anesthesia and endotracheal intubation) are common precursors of hospital-acquired infections. Infections can be transmitted by following ways.

### ► Air-borne transmission

Hospital infections may be transmitted by air-borne droplets, dust particles, and aerosols. Inhalation of air-borne droplets or droplets’ nuclei transmits *Mycobacterium tuberculosis* and many other respiratory pathogens. Hospital dusts generated from beddings, hospital floors, from skin by natural shedding of skin scales are rich sources of many pathogens, such as *S. aureus*, *Pseudomonas aeruginosa*, etc. Therefore, inhalation of these infective dust particles transmits infections. Aerosols produced by nebulizers, humidifiers, and air conditioning apparatus transmit certain pathogen, such as *Legionella pneumophila*.

### ► Transmission by direct contact

Direct contact is the principal route of transmission of hospital-acquired infections. Direct contact with hands and clothings of medical personnel harboring microorganisms may transmit infection from one person to another. *S. aureus* and *S. pyogenes* are two important pathogens that are transmitted by hand contact. Certain pathogen, such as *P. aeruginosa*, can also be transmitted by contact with certain hospital instruments (e.g., endoscopes, bronchoscopes, cystoscopes, etc.) if not properly disinfected.

TABLE 77-1

Common hospital-acquired infections

Nosocomial infection	Causative organisms
Urinary tract infection (catheterization related)	<i>Escherichia coli</i> , <i>Klebsiella</i> spp., <i>Enterobacter</i> spp., <i>Serratia</i> spp., <i>Proteus</i> spp., <i>Pseudomonas</i> spp., <i>Enterococcus faecalis</i> , <i>Candida</i> spp., <i>Staphylococcus epidermidis</i> , and other coagulase-negative staphylococci
Wound infection (burns, postoperative, diabetic foot, etc.)	<i>Staphylococcus aureus</i> , <i>Pseudomonas aeruginosa</i> , <i>Acinetobacter</i> spp., coagulase-negative staphylococci, <i>Escherichia coli</i> , <i>Proteus</i> spp., <i>Enterococcus faecalis</i> , and <i>Streptococcus pyogenes</i>
Respiratory infection (ventilator-associated aspiration in comatose patients, etc.)	<i>Klebsiella</i> spp., <i>Enterobacter</i> spp., <i>Staphylococcus aureus</i> , <i>Escherichia coli</i> , <i>Pseudomonas</i> spp., <i>Acinetobacter</i> spp., <i>Proteus</i> spp., and <i>Legionella pneumophila</i>
Gastrointestinal infection (food poisoning, transmission from infected staff, or patient, etc.)	<i>Salmonella</i> spp., <i>Shigella flexneri</i> , <i>Shigella dysenteriae</i> , <i>Shigella sonnei</i> , and <i>Escherichia coli</i> (in children and neonates)

### ► Transmission by oral route

Certain gastrointestinal pathogens may be transmitted by hospital foods served to hospitalized patients. The food may be the source of antibiotic-resistant *P. aeruginosa*, *E. coli*, *Klebsiella* spp., and other pathogens. These pathogens may colonize the intestine and later cause infection in the susceptible patients.

### ► Transmission by parenteral route

Blood-borne pathogens, such as hepatitis B and C and HIV (human immunodeficiency virus), may be transmitted by transfusion of blood or blood products, through contaminated needles or sharp instruments that have not been properly disinfected.

Infections are also common among residents of long-term care facilities, such as nursing homes, special accommodation facilities, and rehabilitation hospitals. Predisposing factors include intrinsic patient factors (e.g., age and chronic medical conditions), presence of indwelling catheters, close communal living, immobility, incontinence, and frequent transfers back and forth between acute hospitals and the care facility. Urinary and respiratory tract infections and gastroenteritis are common, and outbreaks of scabies have been described.

## Common Types of Hospital Infections

Common types of hospital infections can be grouped as follows:

### ► Urinary tract infections

Urinary tract infections (UTIs) account for as many as 40–45% of nosocomial infections. Although UTIs contribute only 10–15% to prolongation of hospital stay and to extra costs, these infections are important reservoirs and sources for spread of antibiotic-resistant bacteria in hospitals. Almost all nosocomial UTIs are associated with preceding instrumentation or indwelling bladder catheters, which create a 3–10% risk of infection each day.

#### Key Points

##### UTIs:

- Are usually caused by pathogens that spread up the periurethral space from the patient's perineum or gastrointestinal tract, which is seen most commonly in women.
- It is also caused through intraluminal contamination of urinary catheters, usually due to cross-infection by caregivers who are irrigating catheters or emptying drainage bags.
- Pathogens occasionally are transmitted from inadequately disinfected urologic equipments and rarely come from contaminated supplies (e.g., dilute aqueous benzalkonium chloride, an ineffective disinfectant).

The most common pathogens causing UTI are *E. coli*, nosocomial Gram-negative bacilli, enterococci, and *Candida*.

A patient who develops infection while the catheter is in place may complain of urethral discomfort, frequency, fever, and pericatheter discharge. Infection occurring after catheter removal

causes the usual symptoms of UTI. The presence of asymptomatic catheter-associated bacteriuria should not generally indicate a need for antimicrobial therapy. Possible exceptions include immunocompromised patients and patients undergoing urological surgery. Asymptomatic catheter-associated candiduria often reflects vaginal or gastrointestinal carriage.

When symptoms are present, the catheter should be removed; if possible, a urine sample should be sent for culture, and a short course of antibiotic therapy should be given. If the urinary catheter must be kept in place, then antibiotic therapy may relieve the symptoms, but the organism is likely to persist. Prolonged antibiotic therapy in the presence of an indwelling catheter will result in the emergence of antibiotic-resistant organisms.

### ► Nosocomial pneumonia

Nosocomial pneumonia accounts for 15–20% of nosocomial infections. Almost all cases of bacterial nosocomial pneumonia are caused by aspiration of endogenous or hospital-acquired oropharyngeal (and occasionally gastric) flora. Nosocomial pneumonias are associated with more deaths than are infections at any other body site. The risk of dying from nosocomial pneumonia is affected greatly by many factors, including comorbidities, inadequate antibiotic treatment, and the involvement of specific pathogens (particularly *P. aeruginosa* and *Acinetobacter*). Surveillance and accurate diagnosis of pneumonia are often problematic in hospitals because many patients, especially those in the intensive care units (ICUs), have abnormal chest roentgenographs, fever, and leukocytosis potentially induced by many causes.

#### Key Points

Risk factors for nosocomial pneumonia, particularly ventilator-associated pneumonia, include:

- Events that increase the risk of colonization by potential pathogens (e.g., prior antimicrobial therapy, contaminated ventilator circuits or equipment, or decreased gastric acidity).
- Processes that increase the possibility of aspiration of oropharyngeal contents into the lower respiratory tract (e.g., intubation, decreased levels of consciousness, or presence of a nasogastric tube).
- Diseases that reduce host defense mechanisms in the lung and permit overgrowth of aspirated pathogens (e.g., chronic obstructive pulmonary disease, old age, or upper abdominal surgery).

Early-onset nosocomial pneumonia, which manifests within the first 4 days of hospitalization, is most often caused by community-acquired pathogens, such as *Streptococcus pneumoniae* and *Haemophilus* species. Late-onset pneumonia is most commonly caused by *S. aureus*, *P. aeruginosa*, *Enterobacter* species, *K. pneumoniae*, or *Acinetobacter* species—the pathogens of increasing concern in many ICUs. Infection is polymicrobial in as many as 20–40% of cases.

The role of anaerobic bacteria in ventilator-associated pneumonia is not well defined. The appropriate duration of

therapy for nosocomial pneumonia, although usually ranges from 10 to 21 days, is not well studied.

### ► Surgical wound infections

Surgical wound infections account for nearly 30% of all hospital infections. These occur in up to 10% of patients undergoing clean surgery; the incidence varies with complexity of surgery, intrinsic patient risk, and surgical skills.

Most surgical wound infections result from contamination of the surgical wound with the patient's own flora or that of operating-room personnel or environment at the time of the surgery. Postoperative hematogenous seeding of the wound site is uncommon.

The common clinical features of surgical wound infection are localized pain, redness, and discharge. Fever that occurs within 4 weeks of surgery, without other localizing features, is likely to be caused by infection at the surgical site. Superficial wound infection may resolve with or without antibiotics. Deeper or organ-space infection may require imaging for diagnosis, surgical drainage, and antimicrobial therapy guided by culture of purulent material.

The likely causative organisms of surgical wound infections depend on the location and type of surgery. MRSA is most common cause in some hospitals. Gram-negative bacilli (e.g., *E. coli*) are more common causes of infection following gastrointestinal or genitourinary tract surgery.

## Diagnosis of Hospital-Acquired Infections

Diagnosis of hospital-acquired infections is made by routine bacteriological methods, such as direct demonstration of microorganisms in specimens by microscopy, isolation by culture, and testing bacterial isolates for their antibiotics sensitivity pattern. The specimens are usually sampled from possible sources of infections, such as environment, inanimate objects, water, air, food, hospital personnel, etc. The source of infection may be traced by performing phage typing, bacteriocin typing, biotyping, or molecular typing.

## Prevention and Control of Hospital-Acquired Infections

Up to a third of hospital-acquired infections are preventable. The two main arms of prevention are stopping the development of antibiotic resistance and preventing the spread of resistant organisms between patients. Many of the principles for preventing spread of hospital-acquired organisms are well known. There is no single successful recipe, and the approach for individual hospitals is usually based on the epidemiology of the organism and the resources available. For example, the most important measures for preventing nosocomial UTIs are (a) the placement of catheters

only when absolutely necessary and not solely for the convenience of caregivers, (b) the use of aseptic technique for catheter insertion and for urinary tract instrumentation, (c) the manipulation and opening of drainage systems as infrequently as possible, and (d) the removal of catheters as soon as feasible.

Strategies shown to decrease the risk of surgical wound infection include (a) antibiotic prophylaxis, (b) short preoperative hospital stay, (c) optimization of patient's risk factors (e.g., diabetes control), and (d) surveillance of surgical-site infections with feedback to the operating teams. Components of a program to prevent hospital-acquired infection are many. These are listed in Box 77-1.

## Active Surveillance for Hospital-Acquired Infection

Hospital surveillance is the key for successful hospital infection control. This includes prospective collection of high-quality data, their analysis, and timely feedback to healthcare practitioners. To achieve this, hospital surveillance systems need to be prospective, targeted, and risk-adjusted, to use validated definitions and methods, and to be open to valid inter-hospital comparison.

A further recent advance in hospital infection surveillance is the use of molecular methods to identify and type organisms, thereby clarifying the clonal or polyclonal nature of apparent outbreaks. Molecular testing has confirmed that some apparently "endemic" infections are caused by MRSA strains and other bacteria.

## Infection Control Committee

In the twenty first century, the specialty of infection control requires a breadth of expertise that no sole

### Box 77-1 Suggested components of a program to prevent hospital-acquired infection in a hospital

#### Components

1. Compliance with hand washing protocols.
2. Use of aseptic technique for insertion of intravenous and urinary catheters.
3. Compliance with guidelines on antimicrobial use.
4. Proper patient care.
5. Short hospital stays.
6. Early removal of invasive devices.
7. Isolation of infectious patients.
8. Hospital infrastructure and policies.
9. Staff vaccination (e.g., hepatitis B, varicella-zoster, tuberculosis, and influenza).
10. Sharps policy.
11. Adequate sterilization and disinfection of surgical instruments and endoscopes.
12. Infection control program.
13. Active surveillance for hospital-acquired infection.



practitioner can possess. Therefore, every hospital should have an infection control committee. The major responsibilities of the committee should be the control of hospital-acquired infection and monitoring of hygienic practices in the hospital.

The committee essentially is a multidisciplinary team consisting of clinicians, infection control practitioners, a hospital epidemiologist, biostatistician, medical records officer, infectious diseases physician, blood bank officer, and microbiologist. The committee is usually chaired by the medical

superintendent with the medical microbiologist being the member-secretary.

The committee (*a*) reviews regularly the infection control activities of the hospital, (*b*) monitors emergence of drug resistance, (*c*) formulates the antibiotics policy of the hospital, (*d*) recommends suitable sterilization and disinfection procedures in a hospital, and (*e*) maintains data on the incidence and types of infections and antibiotics susceptibility patterns of the common prevalent pathogens.

# Biomedical Waste Management

## Introduction

A vast amount of waste is generated in the process of health-care, research, testing, or related procedures on human beings or animals conducted in hospitals, clinics, labs, or similar establishments. This waste is called *biomedical waste*.

Due to the presence of a higher concentration of infectious and other such hazardous substances, this form of waste requires special attention for its safe disposal. If the waste finds its way back to the community, the results would be disastrous to say the least. It can act as a source of infection to residents or visitors of hospitals, and the chemicals contained in the waste may seep into the surrounding soil and contaminate wells and tanks, thereby polluting them.

Most governments in the world have laws and guidelines ensuring that institutions where biomedical waste is generated take appropriate measures for the safe disposal of such waste. An ordinance to this effect was promulgated in India in 1998 under which the institutes where such waste is generated have been held legally responsible for the safe disposal of biomedical waste.

## Types of Biomedical Waste

Handling of biomedical waste is increasingly associated with the risk of laboratory-acquired infections. Most of these infections include those caused by hepatitis B virus, *Bacillus anthracis*, *Mycobacterium tuberculosis*, *Francisella tularensis*, *Shigella* species, and *Brucella* species. Biomedical wastes are of the following types:

**Human anatomical waste:** This consists of human tissues, organs, and body parts, but does not include teeth, hair, and nails.

**Animal waste:** This consists of all animal tissues, organs, body parts, carcasses, bedding, fluid, blood and blood products, items saturated or dripping with blood, body fluids contaminated with blood, and body fluids removed for diagnosis or removed during surgery, treatment, or autopsy, unless a trained person has certified that the waste does not contain the viruses and agents listed in Risk Group 4. This excludes teeth, hair, nails, hooves, and feathers.

**Microbiology laboratory waste:** This consists of laboratory cultures, stocks or specimens of microorganisms, live or attenuated vaccines, and human or animal cell cultures used in

research and laboratory material that have come into contact with any of these.

**Human blood and body fluid waste:** This consists of blood and blood products, items saturated or dripping with blood, human body fluids contaminated with blood, and body fluids removed for diagnosis during surgery, treatment, or autopsy. This does not include urine or feces.

**Waste sharps:** Waste sharps are clinical and laboratory materials consisting of needles, syringes, blades, or laboratory glass capable of causing punctures or cuts.

**Cytotoxic waste:** The term is commonly used to refer to pharmaceuticals used in treating cancer, e.g., antineoplastics or chemotherapy agents.

The categories of biomedical waste as defined by the Pollution Control Board are listed in Table 78-1.

## Waste Treatment and Disposal

Waste treatment and disposal forms a very important component of the proper waste management program of the hospital. Segregation of infectious waste from noninfectious waste is the most important stage required before treatment and disposal of biomedical wastes. This is required to protect the health of medical personnel coming in contact with infectious biomedical wastes (Table 78-2).

Infectious wastes include microbiology and biotechnology waste, waste sharps, animal wastes, solid wastes, and liquid wastes as mentioned above. These are segregated and collected in different colored plastic bags (Fig. 78-1, Color Photo 72):

### Key Points

- **Black plastic bags** are used for incineration and solid chemical noninfectious wastes.
- **Yellow plastic bags** are used for infectious nonsharp substances.
- **Blue or white bags** are used for disposal of plastics and sharp instruments.
- **Red bags** are used for infectious nonsharp wastes.

## Waste Treatment

There are various methods of treatment of biomedical wastes and are as follows:

TABLE 78-1

## Categories of biomedical waste as defined by the Pollution Control Board

Categories	Nature of biomedical wastes
Category No. 1	Human anatomical waste (human tissues, organs, and body parts)
Category No. 2	Animal waste (animal tissues, organs, body parts, carcasses, bleeding parts, fluid, blood and experimental animals used in research, waste generated by veterinary hospitals/colleges, discharge from hospitals, animal houses)
Category No. 3	Microbiology and biotechnology waste (wastes from laboratory cultures, stocks or specimens of microorganisms live or attenuated vaccines, human and animal cell culture used in research and infectious agents from research and industrial laboratories, wastes from production of biologicals, toxins, dishes and devices used for transfer of cultures)
Category No. 4	Waste sharps (needles, syringes, scalpels blades, glass, etc., which may cause puncture and cuts). This includes both used and unused sharps)
Category No. 5	Discarded medicines and cytotoxic drugs (wastes comprising outdated contaminated and discarded medicines)
Category No. 6	Solid waste (items contaminated with blood and body fluids including cotton, dressings, soiled plaster casts, line beddings, other material contaminated with blood)
Category No. 7	Solid waste (waste generated from disposable items other than the waste sharps, such as tubing, catheters, intravenous sets, etc.)
Category No. 8	Liquid waste (waste generated from laboratory and washing, cleaning, housekeeping, and disinfecting activities)
Category No. 9	Incineration ash (ash from incineration of any biomedical waste)
Category No. 10	Chemical waste (chemicals used in production of biologicals, chemicals used in disinfection, as insecticides, etc.)

TABLE 78-2

## Color coding and type of containers used for disposal of biomedical wastes

Color coding	Type of containers	Waste category	Treatment options
Yellow	Plastic bag	1-3, 6	Incineration/deep burial
Red	Disinfected container/plastic bag	3, 6, 7	Autoclaving/microwaving/chemical treatment
Blue/white translucent	Plastic bag/puncture-proof container	4, 7	Autoclaving/microwaving/chemical treatment, and destruction/shredding
Black	Plastic bag	5, 9, 10 (Solid)	Disposal in secured landfill

**Steam autoclaving:** Steam autoclaving is an appropriate method for treating microbiology laboratory waste, human blood and body fluid waste (if applicable), waste sharps, and nonanatomical animal wastes. It must not be used for treating either human or animal anatomical waste.

Personnel who operate steam autoclaves need to be thoroughly trained in the use of the equipment. The effectiveness of decontamination of biomedical waste is dependent upon the temperature to which the waste is subjected as well as the length of time it is exposed to steam. Because the waste is heated by steam penetration and heat conduction, all air must be displaced and containers holding the waste must have good steam permeability. The penetration of steam into the waste is crucial to the effectiveness of the autoclaving process. For this reason, particular attention must be given to packaging to ensure effective steam penetration.

Special emphasis is given to the type of plastic bags used in the autoclave. Some bags impede steam penetration, while others may melt during the autoclave cycle. Plastic bags, therefore, are assessed under actual working conditions to ensure their effectiveness and integrity throughout the autoclave cycle.

Organic wastes containing oxidizing agents like sodium hypochlorite or solvents are not autoclaved due to their potential for explosion.

**Chemical decontamination:** Chemical decontamination is recommended for treating microbiology laboratory waste, human blood, and body fluid waste. It is not used for treating anatomical waste. Waste sharps may be chemically decontaminated; however, the sharps may not be completely sterilized unless mechanical shredding is involved. Shredding is only done where the shredder is integral to an incinerator, which is sealed to prevent any release.

Direct incineration is the preferred disposal method for waste sharps. If chemical decontamination is used, the following factors should be considered: type of microorganism, degree of contamination, type of disinfectant used, and concentration and quantity of disinfectant. Other relevant factors include temperature, pH, degree of mixing, and the length of time the disinfectant is in contact with the contaminated waste.

Sodium hypochlorite (household bleach) is often used as an intermediate-level disinfectant, with the undiluted commercial product normally being a 5.25% solution of sodium hypochlorite (50,000 mg/L of free available chlorine). If a diluted hypochlorite solution is used, it should be made up daily in order to prevent loss of germicidal action.

**Incineration:** Incineration is a process in which combustible materials are converted into noncombustible residue or ash,

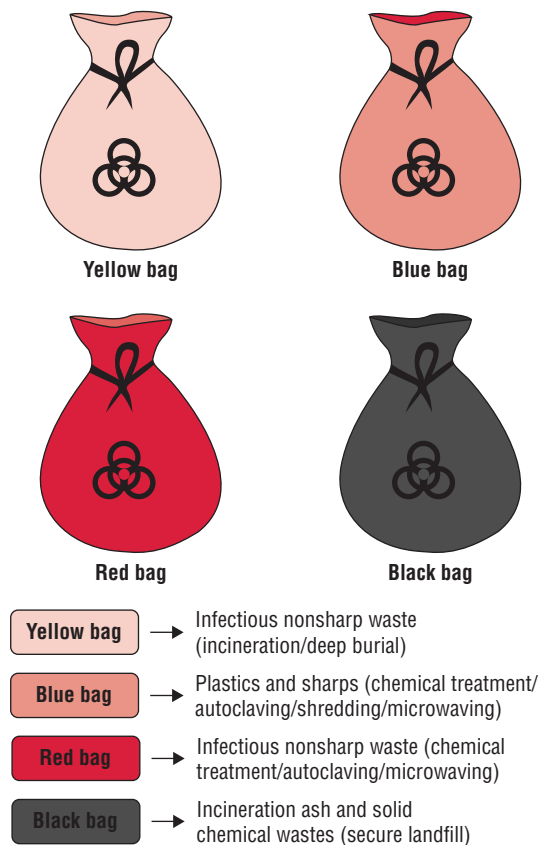

**FIG. 78-1.** Different containers used for disposal of biomedical wastes. For actual figure, please refer Color Photo 72.

achieving a reduction of 90% by volume or 75% by weight when the incinerator is properly operated. Incineration has traditionally been the principal method used by hospitals, medical colleges, and other healthcare facilities providers to process their anatomical and nonanatomical biomedical wastes. To date, incineration is the only disposal technology proven to be capable of handling all components of the biomedical waste stream.

**Microwave treatment:** Radiations produced by microwave are increasingly used nowadays for treatment of infectious hospital wastes. The microwaves heat the biological wastes to a temperature of 97–100°C in a 40–45 minutes cycle. The advantage of the method is that it is not associated with any hazardous emissions, but it cannot be used to treat anatomical body parts and tissues.

**Plasma torch:** Waste treatment by plasma torch produces a very high temperature that is very useful for treatment of biological wastes. It is a very safe method, although it is highly expensive.

## Disposal of Biomedical Wastes

Landfill, deep burial, and sewage are different methods used for safe disposal of biomedical wastes. Landfill or deep burial—although is a safe method for disposal of sharps, and also for products of chemical disinfection—requires the presence of large areas of uninhabited land. Trenches are dug where the waste is buried and are covered with lime.

# Immunoprophylaxis

## Introduction

Immunoprophylaxis is the prevention of disease by the production of active or passive immunity. The incidence of diseases, such as diphtheria, measles, mumps, pertussis (whooping cough), rubella (German measles), poliomyelitis, and tetanus, has declined dramatically as vaccination has become more common.

Vaccination is a cost-effective weapon for disease prevention. Use of vaccines has contributed solely in the eradication of smallpox, one of mankind's long-standing and most terrible scourges. Since October 1977, not a single naturally acquired smallpox case has been reported anywhere in the world. Other diseases like diphtheria, pertussis, tetanus, measles, mumps, rubella, and poliomyelitis, also known as "vaccine preventable diseases" have been successfully brought down to negligible levels in most developed nations and in some cases in the developing nations as well.

Immunity to infectious microorganisms can be achieved by active or passive immunization. In each case, immunity can be acquired either by natural processes (usually by transfer from mother to fetus or by previous infection by the organism) or by artificial means, such as injection of antibodies or vaccines. The agents used for inducing passive immunity include antibodies from humans or animals, whereas active immunization is achieved by inoculation with microbial pathogens that induce immunity but do not cause disease or with antigenic components from the pathogens.

## Active Immunization

Active immunization can be achieved by natural infection with a microorganism, or it can be acquired artificially by administration of a vaccine. In active immunization, as the name implies, the immune system plays an active role. Proliferation of antigen-reactive T and B cells results in the formation of memory cells. Active immunization with various types of vaccines has played an important role in the reduction of deaths from infectious diseases, especially among children. Vaccines may be (a) live attenuated, (b) killed, or (c) in the form of toxoids.

### Key Points

#### Two forms of immunoprophylaxis:

- (i) **Routine immunization**—used for all children.
- (ii) **Immunization of individuals or selected groups**—used for individuals or groups exposed to risk of specific diseases.

## Live Attenuated Vaccines

These vaccines, as the name suggests, contain live attenuated organisms that have lost their pathogenicity but have antigenicity. The attenuated organisms are the suspensions of live organisms with reduced virulence. These organisms multiply in the body and thereby provide a continuous antigenic stimulus, resulting in production of protective antibodies.

Bacille Calmette–Guérin (BCG); smallpox vaccine; oral polio vaccine (OPV); mumps, measles, and rubella (MMR) vaccine; and yellow fever vaccine are some of the examples of live vaccines. These live vaccines are usually contraindicated for use in immunocompromised patients, such as patients with HIV (human immunodeficiency virus), leukemia, malignancies, etc.

## Killed Inactivated Vaccines

These vaccines contain killed pathogens, hence do not replicate in body. At least three doses of killed vaccine followed by a booster dose are essential to confer protective immunity. Typhoid, cholera, pertussis, pneumococcal, rabies, hepatitis B, and influenza vaccines are the examples of killed attenuated vaccines.

## Toxoids

Toxoids are modified toxins, which have retained their antigenicity but have lost their toxicity.

### Key Points

- Toxoids are given to confer protection against diseases that are caused by production of toxins.
- Two toxoids most widely used for immunization are tetanus toxoid and diphtheria toxoid.
- DPT (diphtheria, pertussis, tetanus) vaccine is a triple vaccine, which consists of tetanus and diphtheria toxoids and pertussis killed vaccine.

Adsorption of toxoid to a mineral carrier, such as aluminum hydroxide or aluminum phosphate enhances antigenicity of toxoids. This is because these adsorbed toxoids remain longer in a depot after injection and continue to stimulate immune system of host for a longer period of time. These are usually prepared by treating toxins with formalin.

## Subunit Vaccines

Subunit vaccines are specialized vaccines that are prepared by purifying the fragments of major immunogenic components of microorganisms and are produced by recombinant DNA technology (hepatitis B subunit vaccine).

## Immunization Schedule

### WHO Immunization Program

Following the successful global eradication of smallpox in 1975 through effective vaccination programs and strengthened surveillance, the Expanded Programme on Immunization (EPI) was launched in India in 1978 to control other vaccine preventable diseases. Initially, six diseases were selected: diphtheria, pertussis, tetanus, poliomyelitis, typhoid, and childhood tuberculosis. The aim was to cover 80% of all the infants. Subsequently, the program was universalized and renamed as Universal Immunization Program (UIP) in 1985. Measles vaccine was included in the program and typhoid vaccine was discontinued. The UIP was introduced in a phased manner from 1985 to cover all districts in the country by 1990, targeting all infants with the primary immunization schedule and all pregnant women with tetanus toxoid immunization.

### Key Points

#### Universal Immunization Program:

- It envisages achieving and sustaining universal immunization coverage in infants with three doses of DPT and OPV and one dose each of measles vaccine and BCG, and in pregnant women with two primary doses or one booster dose of tetanus toxoid.
- It also requires a reliable cold-chain system for storing and transporting vaccines and attaining self-sufficiency in the production of all required vaccines.

In 1992, the UIP became a part of the Child Survival and Safe Motherhood Programme (CSSM), and in 1997, it became an important component of the Reproductive and Child Health Programme (RCH). The cold-chain system was strengthened and training programs were launched extensively throughout the country. Intensified polio eradication activities were started in 1995–1996 under the Polio Eradication Programme, beginning with National Immunization Days (NIDs) and active surveillance for acute flaccid paralysis (AFP). The Polio Eradication Programme was set up with the assistance of the National Polio Surveillance Project.

### National Immunization Schedule

National immunization schedule is mentioned in Table 79-1. EPI's immunization schedule is mentioned in Table 79-2.

TABLE 79-1

### Universal immunization schedule in India

Age	Vaccine	Route of administration
<b>Primary vaccination</b>		
At birth	BCG	Intradermal
	OPV—zero dose	Oral
6 weeks	OPV—1st dose	Oral
	DPT—1st dose	Intramuscular
10 weeks	OPV—2nd dose	Oral
	DPT—2nd dose	Intramuscular
14 weeks	OPV—3rd dose	Oral
	DPT—3rd dose	Intramuscular
9–12 months	Measles vaccine	Subcutaneous
<b>Booster doses</b>		
16–24 months	OPV	Oral
	DPT	Intramuscular
5 years	DT	Intramuscular
10 years	TT	Intramuscular
16 years	TT	Intramuscular
<b>Pregnant women</b>		
<i>Gestational period</i>		
As early as possible during pregnancy (first contact)	TT—1st dose	Intramuscular
1 month after 1st dose	TT—2nd dose	Intramuscular
If previously vaccinated, within 3 years	TT—booster	Intramuscular
BCG, bacille Calmette–Guérin; OPV, oral polio vaccine; DPT, diphtheria, pertussis, tetanus; DT, diphtheria and tetanus toxoids; TT, tetanus toxoid.		

TABLE 79-2

### EPI's immunization schedule

Age	Disease	Vaccine
At birth	Tuberculosis, polio	BCG, OPV
6 weeks	Diphtheria, pertussis, tetanus; polio	DPT-1, OPV-1
10 weeks	Diphtheria, pertussis, tetanus; polio	DPT-2, OPV-2
14 weeks	Diphtheria, pertussis, tetanus; polio	DPT-3, OPV-3
9 months	Measles	Measles vaccine
EPI, Expanded Programme on Immunization; BCG, bacille Calmette–Guérin; OPV, oral polio vaccine; DPT, diphtheria, pertussis, tetanus.		

### Passive Immunization

Passive immunization is carried out by administration of human and animal sera, which serve as the readymade source of prepared antibodies against a particular pathogen. These are given to an individual to confer immediate protection against particular pathogen. The immunity, however, is of short duration.

## Human Sera

Normal human immunoglobulins include (a) pooled human immunoglobulin, and (b) specific hyperimmune immunoglobulin.

### ► Pooled human immunoglobulin

Pooled human immunoglobulin is prepared from normal human serum containing a high concentration of a particular antibody. It is usually used for short-term prophylaxis of hepatitis A, measles, etc.

### ► Specific hyperimmune immunoglobulin

Specific hyperimmune immunoglobulin is prepared from patients convalescing from the disease or from individuals actively immunized against a specific disease. These hyperimmune sera are available against a variety of diseases. Examples are human rabies immunoglobulin (HRIG) against rabies, human tetanus immunoglobulin (HTIG) against tetanus, hepatitis B immunoglobulin (HBIG) against hepatitis B, and varicella zoster immunoglobulin (ZIG) against varicella zoster.

These hyperimmune sera are usually given intramuscularly. They are usually not given shortly before or after active immunization in order to avoid inhibition of immune responses.

## Animal Sera

Animal sera are prepared in animals. These sera rich in antibodies are produced by active immunization of animals, such as horses. Antitetanus serum and antivenom sera are examples of such sera used against tetanus and snake bites, respectively. Disadvantages of these sera are that in some recipients they may cause serum sickness and anaphylaxis; moreover, they are eliminated much rapidly from humans.

## Combined Active and Passive Immunization

Combined active and passive immunization is often carried out to confer slowly developing immunity and immediate passive immunity, respectively, against certain diseases, such as diphtheria, tetanus, and rabies.

## Individual Immunization

The vaccines mentioned in the universal immunization schedule are selected on the basis of economic considerations and the epidemiology of infectious diseases in the region. But there are many vaccines available, which can be used to supplement the schedule depending on the individual cases and affordability.

## Hepatitis B Vaccine

Hepatitis B virus (HBV) is transmitted from one person to another through blood and body fluids, and primarily infects

the liver. Healthcare workers and others exposed to infected blood or body fluids are at high risk for infection. Worldwide, it is most commonly spread to infants by their infected mothers. Approximately 90% of infants who are infected from their mothers at birth, and between 30% and 50% of those infected before age of 5 years, become chronic HBV carriers, while people who are newly infected as adults have only a 6–10% risk of chronic infection. For these reasons, hepatitis B immunizations are recommended for routine administration at birth.

- Vaccination with at least three doses of the hepatitis B vaccine is recommended.
- All newborns should receive a dose of hepatitis B vaccine at birth.
- For children between the ages of 6 weeks and 7 years, HBV in combination with the DTP and inactivated polio vaccines may be given.
- HBV and Hib (*Haemophilus influenzae* type b) conjugate vaccine may be given to children between the ages of 6 weeks and 15 months.

Dialysis patients and immunocompromised people may require additional doses.

## MMR Vaccine

Measles vaccine is usually given with the mumps and rubella vaccines in children 12–15 months of age and older.

- Two doses of MMR vaccine are recommended for all children on or after the first birthday, including those who previously received the monovalent measles vaccine.
- The first dose is generally given at 12–15 months of age, and the second dose is generally given at 4–6 years of age. There must be a minimum of 4 weeks between the two doses.
- The second dose of MMR vaccine provides an added safeguard against all three diseases, but is recommended primarily to prevent outbreaks of measles.

Students who are exposed to an outbreak but have not already received two doses of the vaccine and who do not have other proof of immunity may be excluded from school for the entire duration of the outbreak or are required to receive the measles vaccination. The second dose of the measles vaccine series is effective when given as early as 1 month after the first dose, and this schedule is used when protection is needed quickly. Ninety-five percent of those who receive the MMR or monovalent measles vaccine at 12 months of age or older become immune after the first dose. After the second dose, 99.7% of those immunized are protected. Immunity is lifelong.

There are hypotheses that the MMR vaccine causes autism. However, the best available science indicates that the development of autism is not related to the use of the MMR or any other vaccine. One small study seemed to postulate such a link, but has subsequently been disproved by many other larger studies. Ten of the thirteen authors of that study later retracted from their suggestion of a link between MMR vaccine and autism.

## Typhoid Vaccine

---

Two newer vaccines, recently, have replaced the older vaccine used in typhoid fever. These vaccines are:

- an oral live attenuated vaccine using a weakened strain of *Salmonella Typhi* that is given orally and
- a parenteral capsular polysaccharide vaccine that is given by injection.

The oral typhoid vaccine can be administered to children 6 years of age or older and to adults. It is given in a total dosage

of four capsules, one capsule taken orally every other day. A booster dose is needed every 5 years for people who continue to remain at risk.

The polysaccharide typhoid vaccine is given by injection to children older than 2 years of age. One shot is enough to provide protection. A booster dose is needed every 2 years for people who remain at risk for exposure.

The efficacy of the two licensed vaccines ranges from 50% to 80%. The oral vaccine has shown a protective efficacy of 62% for at least 7 years after the last dose.



# Index

## A

- A and B antigens 168  
Abnormal immunoglobulins 100  
ABO blood group system 167  
ABO hemolytic diseases 170  
Abortive infections 435  
Abortive poliomyelitis 499  
Abortive transduction 52  
Acellular vaccines 334  
Acid-fast stain 13  
Acidity of water 623  
Acidophilic inclusion bodies 468, 474  
*Acinetobacter baumannii* 313  
Acquired CMV infection 486  
Acquired immunity 87  
*Actinobacillus actinomycetemcomitans* 327  
*Actinomadura madurae* 601  
*Actinomyces europaeus* 393  
*Actinomyces gerencsonei* 393  
*Actinomyces israeli* 393, 621  
*Actinomyces meyeri* 393  
*Actinomyces naeslundii* 393  
*Actinomyces odontolyticus* 393  
*Actinomyces radingae* 393  
*Actinomyces turicensis* 393  
*Actinomyces viscosus* 393  
*Actinomyces* 13, 393  
Actinomycetes with mycolic acids 393  
Actinomycetes without mycolic acid 393  
Actinomycetoma 601  
Actinomycosis 394  
Actinomycosis of pelvis 394  
Actinomycotic mycetoma 396  
Activation of T cells 127  
Activators of the alternative pathway 119  
Activators of the classical pathway 117  
Active immunity 88, 89  
Active immunization 550, 637  
Active surveillance for hospital-acquired infection 632  
Acute brucellosis 340  
Acute follicular conjunctivitis 491  
Acute glomerulonephritis 188  
Acute HCV infection 555  
Acute hemorrhagic conjunctivitis 503  
Acute hemorrhagic cystitis 491  
Acute herpetic gingivostomatitis 476  
Acute herpetic pharyngotonsillitis 476  
Acute HIV infection 570  
Acute leukemia viruses 562  
Acute melioidosis 319  
Acute pulmonary histoplasmosis 604  
Acute-phase proteins 87  
Adansonian classification 45  
Addison's disease 158  
Adeno-associated viruses (AAVs) 492  
Adenovirus infections in immunocompromised host 491  
Adenylate cyclase toxin 332  
Adjuvants 91, 136  
Adoptive immunity 136, 139  
Adult inclusion conjunctivitis 421  
Adult T-cell leukemia 564  
Advantages and disadvantages of polio vaccines (Table 60-3) 501  
*Aeromonas* 304  
*Aeromonas hydrophila* 304  
*Aeromonas jandaii* 304  
*Aeromonas schubertii* 304  
*Aeromonas veronii* 304  
Aerophobia 532  
Affinity 101  
Aflatoxin 595  
African horse sickness virus 537  
Agar dilution method 70, 71  
Agglutination and other features of *Brucella* species (Table 40-3) 340  
Agglutination reactions 106  
AIDS dementia complex 571  
AIDS-associated malignancy conditions 571  
AIDS-related complex 570  
Air-borne transmission 630  
Albert's stain 13  
*Alcaligenes faecalis* 400  
Aldehydes 31  
Alkaescens-Dispar Group 257  
Alkaline peptone water 295  
Alkali-stable polysaccharide antigen 408  
Allergic bronchopulmonary aspergillosis 611  
Allergic pneumonitis  
Allotypes 96  
Alpha-fetoprotein 164  
Alphavirus 538  
*Amblyomma americana* 412  
Amidase test 353  
Anaerobic actinomycetes 393  
Anaerobic bacilli 247  
Anaerobic cocci 247  
Anaerobic culture methods 39  
Anaerobic glove box 40  
Anaerobic Gram-negative bacilli 248  
Anaerobic streptococci 235, 394  
Anaphylactoid reaction 151  
Anaphylaxis  
clinical manifestations of 151  
initiator cells in 149  
management and prevention of 151  
mediators of 150  
phases of 150  
Andrade's indicator 37, 42  
Anicteric leptospirosis 383  
Animal inoculation test (Table 48-2) 410  
Animal models of autoimmunity 158  
Animal waste 634  
Anogenital warts 470  
Antemortem diagnosis of human rabies 533  
Anthrax and biological warfare (Box 28-1) 227  
Anthrax immunization 229  
Anthrax meningitis 226  
Anthrax spores 223  
Anthrax toxin complex 224  
Antibacterial assays 71  
Antibiotic resistance 64  
mechanisms of 64  
Antibiotic sensitivity testing 68  
Antibodies 94  
function of 137  
Antibody-based serological testing in HIV 573  
Antibody-dependent cell-mediated cytotoxicity (ADCC) 152  
Anti-dsDNA antibodies 160  
Antifungal agents and primary sites of activity (Table 71-4) 596  
Antifungal drugs 596  
Antigen 90  
Antigen alteration 157  
Antigen-antibody reactions 101  
Antigenic determinants 88  
Antigenic drift 510  
Antigenic phase variation 381  
Antigenic shift 507  
Antigenic specificity 91  
Antigenic structure of *Streptococcus pyogenes* 184  
Antigenic structure of *Yersinia enterocolitica* 292  
Antigenic variations 507  
Antigens of various serotypes of *Shigella flexneri* (Table 33-3) 282  
Anti-HIV drugs 575  
Antileprosy drugs 370  
Antileprosy vaccines 370  
Antimicrobial agents: therapy and resistance 61  
Antimicrobial chemotherapy 61  
Antimicrobial drugs  
mechanisms of action of 61  
resistance to 64  
Antinuclear antibodies 160  
Antirabies vaccine 534  
Antiretroviral drugs against HIV (Box 68-1) 576  
Antiretroviral treatment 575  
Antiseptics 24  
Antituberculous drugs 356

## 642 INDEX

- Antiviral drugs 449  
Antony van Leeuwenhoek 4  
Apoptosis 443  
Applications of DNA probes 57  
Arbovirus 536  
*Arcanobacterium* 221  
Arenavirus 586  
Armadillo 362  
Arnold's steam sterilizer 25  
Arthritis-dermatitis syndrome 204  
Arthrovirus 496  
Arthus reaction 153  
Artificial active immunity 88  
Artificial passive immunity 89  
Arylsulfatase test 353  
Ascending tetanus 241  
Ascoli's thermoprecipitation test 228  
Aseptic meningitis 383  
Asexual state of selected dermatophytes (Table 72-2) 599  
Aspergilloma 611  
Aspergillosis 610  
*Aspergillus clavatus* 610  
*Aspergillus fumigatus* 610  
*Aspergillus niger* 610  
*Aspergillus* species 610  
Assay of infectivity of viruses 458  
Associated coronavirus (SARS-CoV) 588  
Asteroid bodies 602  
Asymptomatic catheter-associated bacteriuria 631  
Asymptomatic catheter-associated candiduria 631  
Asymptomatic congenital CMV infection 486  
Ataxia telangiectasia 145  
Athlete's foot 598  
Atopy 151  
Atypical forms of bacteria 16  
Atypical measles 516  
Atypical pneumonia 392  
Auramine O stain 346  
Australian tick typhus 413  
Autoantibodies 158  
Autoantibody associated diseases 158  
Autoclave 26  
Autoimmune disorders (Table 20-1) 159  
Autoimmune hemolytic anemia 158  
Autoimmunity 156  
Automated radiometric culture methods 355  
Automated reagin test 376  
Autospecificity 92  
Avian leukosis complex virus 562
- B**
- B lymphocytes 128  
Babe-Ernest's granules 214  
*Bacillary angiomatosis* 405  
*Bacillary dysentery* 284  
Bacillary index 367  
Bacille Calmette-Guérin (BCG) vaccine 370  
*Bacillus anthracis* 222  
    identifying features of (Box 28-2) 228  
*Bacillus cereus* food poisoning 229  
*Bacillus licheniformis* 229  
Bacillus spores 224  
*Bacillus stearothermophilus* 229  
*Bacillus subtilis* 229  
Bacitracin sensitivity test 190  
BACTEC 355  
Bacterial classification 45  
Bacterial count 21  
Bacterial exotoxins  
    mechanism of action of (Table 10-8) 81  
Bacterial flora in water (Table 76-1) 623  
Bacterial flora of milk 626  
Bacterial growth curve 22  
Bacterial resistance 64  
Bacterial taxonomy 45  
Bacterial virulence factors (Table 10-6) 78  
Bacteriocin typing 45  
Bacteriological examination of air 628  
Bacteriological examination of milk 627  
Bacteriological examination of water 624  
Bacteriology of water, milk, and air 623  
Bacteriophage typing 462  
Bacteriophages 460  
*Bacteroides* 248  
*Bacteroides distasonis* 248  
*Bacteroides fragilis* 248  
*Bacteroides thetaiotaomicron* 248  
*Bacteroides ureolyticus* 248  
*Bacteroides vulgatus* 248  
*Bartonella* 404  
*Bartonella bacilliformis* 405  
*Bartonella henselae* 405  
*Bartonella quintana* 405  
B-cell deficiencies 147  
B-cell epitopes 91  
B-cell immunodeficiencies 143  
B-cell tolerance 156  
Bejel 378  
Bence-Jones (BJ) proteins 100  
*Benekea vulnificus* 303  
Benign tumors of head and neck 470  
Berkefeld filters 28  
Beta-D-glucan assay 610  
Beta-hemolytic streptococci 183  
Beta-propiolactone 32  
Bhanja virus 546  
*Bifidobacterium dentium* 394  
Bile solubility test 199  
Biochemical characteristics of *Nocardia asteroides* complex and *Nocardia brasiliensis* (Table 46-2) 396  
Biochemical products of recombinant DNA technology 59  
Biochemical reactions of common *Salmonella* spp. (Table 32-2) 270  
Biological effects of complement 120  
Biological controls used for testing efficacy of sterilization techniques (Table 3-3) 29  
Biological false positive reactions of standard tests of syphilis (Table 44-3) 376  
Biomedical waste management 634  
Biosynthesis of DNA viruses 434  
Biosynthesis of immunoglobulins 96  
Biosynthesis of RNA viruses 434  
Biotypes of *Shigella flexneri* serotype 6 (Table 33-4) 283  
Biotyping 45  
BK polyomavirus 472  
BK virus 472  
Black piedra 597  
Blastomycosis 605  
Blocking antibodies 343  
Blood group antigens 167  
Blood transfusion 168  
    complications of 169  
Blood transfusion-associated CJD 582  
Boiling 25  
Bolivian hemorrhagic fever 587  
Bollinger bodies 444  
Bombay antigen 168  
Bone marrow culture 277, 342  
Bone marrow-derived lymphocytes 128  
Borderline lepromatous leprosy 365  
Borderline tuberculoid leprosy 365  
*Bordetella avium* 330  
*Bordetella bronchiseptica* 335  
*Bordetella parapertussis* 334  
*Bordetella pertussis* 330  
Bordet-Gengou agar 330  
*Borrelia burgdorferi* 378, 381  
*Borrelia duttoni* 378  
*Borrelia henselae* 378  
*Borrelia parkeri* 378  
*Borrelia recurrentis* 378  
*Borrelia tunicatai* 378  
*Borrelia vincenti* 381  
Botulinum toxin 243  
Bovine spongiform encephalopathy 581  
*Brevibacterium* 221  
Bright-field microscopy 9  
Brill-Zinsser's disease 409  
Broth dilution method 71  
*Brucella canis* 338  
Brucella endocarditis 341  
*Brucella melitensis* 338  
*Brucella neotomae* 338  
Brucella skin test 343  
*Brucella suis* 338  
Bubonic plague 288  
Buffalopox 467  
Bulbar poliomyelitis 499  
Bunyaviruses 536  
*Burkholderia cepacia* 313, 318  
*Burkholderia mallei* 318  
*Burkholderia pseudomallei* 313, 318  
Burkitt's lymphoma 571  
Bursa of Fabricius 123  
Bursting factor 234  
Buruli ulcer 360  
Butzler medium 307
- C**
- C reactive protein 87, 196  
California encephalitis virus 544  
*Calymmatobacterium* 400  
CAMP (Christie, Atkins, and Munch-Peterson) reaction 399  
CAMP test 191  
*Campylobacter* 305  
*Campylobacter coli* 305  
*Campylobacter enteritis* 307  
*Campylobacter fetus* 305  
*Campylobacter hyointestinalis* 305  
*Campylobacter jejuni* 305  
*Campylobacter lari* 305  
*Candida albicans* 608  
*Candida glabrata* 609  
Candida heat-labile-antigen assay 610  
*Candida krusei* 610  
Candida mannan assay 610  
*Candida parapsilosis* 609  
*Candida tropicalis* 609  
Candidiasis 608  
Canine distemper virus 515  
Capacity (Kelsey-Sykes) test 33

- Capnocytophages gingivalis* 406  
*Capnocytophages ochracea* 406  
*Capnocytophages sputigena* 406  
 Capsular swelling reaction 196  
 Capsule 18  
     chemical composition (Table 2-4) 18  
 Carbohydrate fermentation test 42  
*Cardiobacterium hominis* 328  
 Cardiolipin antigen 372  
 Cardiovirus 496  
 Castaneda's biphasic method of blood culture 277  
 Castaneda's method of blood culture 342  
 Catalase-negative strains of *Mycobacterium tuberculosis* 346  
 Catalase test 41, 353  
 Cat-scratch disease 405  
 Causative agents of mutation 48  
 Causative agents of subcutaneous mycoses (Table 72-4) 600  
 Cell culture 456  
 Cell culture vaccines 534  
 Cell lines in common use (Table 53-3) 456  
 Cell-mediated immunity 88, 138, 445  
 Cellular oncogenes 562  
 Cellular target sites of antibiotics (Table 9-2) 64  
 Cellulitis 188, 235  
 Cell wall deficient forms 16  
 Cell wall of *Mycobacterium* 345  
 Cephalic tetanus 240  
 Cephalosporins used in clinical practice (Table 9-1) 61  
*Ceratophyllum fasciatum* 289  
 Cervicofacial actinomycosis 394  
 Chamberlain filters 28  
 Chandipura virus 546  
 Characteristics of various genera in the family Paramyxoviridae (Table 62-2) 523  
 Chediak-Higashi syndrome 146  
 Chemical methods of sterilization 29  
 Chemiluminescence assay 114  
 Chemoprophylaxis against leprosy 370  
 Chick embryo inoculation 455  
 Chick Martin test 33  
 Chikungunya virus 538  
 Chimeric antibodies 137  
*Chlamydia* 418  
*Chlamydia pecorum* 418  
*Chlamydia pneumoniae* 419, 424  
*Chlamydia psittaci* 418  
*Chlamydia trachomatis* 419  
*Chlamydophila* 423  
*Chlamydophila pneumoniae* 424  
*Chlamydophila psittaci* 424  
 Cholera pandemics 299  
 Cholera red reaction 295  
 Cholera toxin 296  
 Cholera vaccines 302  
*Chromobacterium violaceum* 400  
 Chromoblastomycosis 601  
 Chromomycosis 601  
 Chromosomal walking 56  
 Chromosome-mediated resistance 65  
 Chronic B19 infection 494  
 Chronic brucellosis 342  
 Chronic granulomatous disease 146  
 Chronic HBV infection 552  
 Chronic HCV infection 556  
 Chronic leukemia viruses 562  
 Chronic mucocutaneous candidiasis 144, 609  
 Chronic necrotizing aspergillus pneumonia 611  
 Chronic necrotizing pulmonary aspergillosis 611  
 Chronic pulmonary histoplasmosis 604  
 Chronic wasting disease of deer, mule, and elk 581  
 Citrate test 43  
 Citrobacter 261  
*Citrobacter amalonaticus* 261  
*Citrobacter freundii* 261  
*Citrobacter species*  
     important properties used for differentiation of (Table 31-8) 261  
*Cladosporium carrionii* 601  
*Cladosporium werneckii* 597  
 Classes of immunoglobulins and their heavy chains and subclasses (Table 13-1) 95  
 Classical pathway of complement activation 117  
 Classification and important properties of picornaviruses of medical importance (Table 60-2) 497  
 Classification and typing of *Salmonella* 275  
 Classification of *Enterococcus* (Table 24-6) 193  
 Classification of fungi 593  
 Classification of human adenoviruses (Table 58-1) 489  
 Classification of human herpesviruses (Table 57-1) 473  
 Classification of leprosy 364  
 Clinical diagnosis of the zygomycosis 612  
 Clinical syndromes associated with HPV (Table 56-2) 470  
 Clonal anergy 142, 156  
 Clonal deletion 142, 156  
 Clonal ignorance 156  
 Clonal selection theory 8, 136  
 Cloning hosts 59  
 Cloning vectors 59  
 Clostridial food poisoning 235  
*Clostridium botulinum* 242  
     identifying features of (Box 29-3) 245  
     virulence factors of (Table 29-3) 238  
*Clostridium difficile* 245  
*Clostridium perfringens*  
     identifying features of (Box 29-1) 237  
*Clostridium tetani*  
     identifying features of (Box 29-2) 241  
     virulence factors of (Table 29-4) 243  
*Clostridium welchii* toxin neutralization test 110  
 Clot culture 277  
 CMI in vitro tests 141  
 CMV 482  
 CMV infection in immunocompetent adult hosts 486  
 CMV infection in immunocompromised host 486  
 CNS cryptococcosis 607  
 Coagglutination test 109  
 Coagulase-negative staphylococci 181  
 Coagulase test 179  
 Coccidioides 596  
 Coccidioidomycosis 603  
 Coccidiomycosis 596  
 Col factor 50  
 Cold agglutination test 390  
 Cold sterilization 28  
 Colicinogenic (Col) factor 50  
 Collection of water samples for analysis 624  
 Colonization factor antigens 254  
 Colonization of the lower airways 620  
 Color coding and type of containers used for disposal of biomedical wastes (Table 78-2) 635  
 Colorado tick-borne virus 546  
 Colorado tick fever 525  
 Colorado tick fever virus 525  
 Coltivirus 525  
 Combined active and passive immunization 639  
 Combined B-cell and T-cell deficiencies 145  
 Common cold viruses 503  
 Common hospital-acquired infections (Table 77-1) 630  
 Common liquid media (Table 4-1) 35  
 Common opportunistic infections (Table 74-1) 608  
 Common solid media (Table 4-2) 35  
 Common types of hospital infections 631  
 Common variable hypogammaglobulinemia 147  
 Commonly used tests in clinical microbiology (Table 14-1) 102  
 Community-acquired bacterial pneumonia 324  
 Comparison of classical, alternative, and lectin pathways (Table 15-1) 119  
 Comparison of different types of hypersensitivity reactions (Table 19-4) 155  
 Comparison of fungi and bacteria (Table 71-1) 593  
 Comparison of Legionnaire's disease and Pontiac fever caused by *Legionella pneumophila* (Table 47-2) 403  
 Comparison of multiplication of bacteriophages and viruses (Table 54-1) 462  
 Comparison of rat-bite fever caused by *Streptobacillus* and *Spirillum* species (Table 47-1) 402  
 Comparison of Th-1 cells and Th-2 cells (Table 16-2) 126  
 Comparison of transformation, transduction, and conjugation (Table 7-1) 54  
 Comparison of various properties of immunoglobulins (Table 13-2) 97  
 Competitive ELISA 113  
 Complementary DNA 56  
 Complement deficiencies 147  
 Complement-dependent serological tests 109  
 Complement fixation test 109, 390  
 Complement immunodeficiencies 145  
 Complement system 109, 116  
 Complications of measles 516  
 Complications of mumps 520  
 Conditional lethal mutation 49  
 Condyloma acuminata 471  
 Confirmatory test used in HIV serology 574  
 Congenital aplasia of thymus 123  
 Congenital CMV infection 486  
 Congenital rubella syndrome 584  
 Congenital syphilis 374  
 Conglutinating complement adsorption test 110  
 Conjugation 49, 53  
 Contact hypersensitivity 154  
 Continuous cell lines 457  
 Continuous culture 22  
 Coombs test 107  
 Cord factor 348  
 Coronaviruses 588  
*Corynebacterium amycolatum* 220  
*Corynebacterium diphtheriae* 213  
*Corynebacterium equi* 397  
*Corynebacterium glucuronolyticum* 220  
*Corynebacterium hemolyticum* 213, 220

- Corynebacterium jeikeium* (group JK) 213, 220  
*Corynebacterium pseudodiphtheriticum* 213  
*Corynebacterium pseudotuberculosis* 220  
*Corynebacterium riegeltii* 220  
*Corynebacterium striatum* 213, 220  
*Corynebacterium ulcerans* 213, 220  
*Corynebacterium vaginalis* 406  
 Cough plate method 333  
 Counter-current immunoelectrophoresis 105  
 Cowan I strain of *Staphylococcus aureus* 109  
 Cowpox 467  
*Coxiella burnetii* 416  
 Coxsackieviruses A 501  
 Coxsackieviruses B 501  
 Craigie's tube 272  
 Cresol 30  
 Creutzfeldt-Jakob disease 580  
 Crimean-Congo hemorrhagic fever 544  
 Crimean-hemorrhagic fever viruses 544  
 Cryptococcal meningitis 596  
 Cryptococcosis 606  
 Cryptococcus 596  
*Cryptococcus neoformans* var *gattii* 606  
*Cryptococcus neoformans* var *neoformans* 606  
*Ctenocephalides felis* 411  
 Culture-negative endocarditis 328  
 Cutaneous candidiasis 609  
 Cutaneous diphtheria 216  
 Cutaneous nocardiosis 396  
 Cytokines  
   important functions of (Table 17-1) 140  
 Cytomegalic inclusion disease 486  
 Cytopathic effects of viruses (Table 51-1) 442  
 Cytopathogenic viruses 453  
 Cytotoxic T cells 128  
 Cytotoxic T lymphocytes/cells (CTLs) 88  
 Cytotoxic waste 634
- D**
- 
- Dane particle 550  
 Dark field microscopic examination 401  
 Dark-ground microscopy 10  
*Dasyus novemcinctus* 362  
 Defective viruses 435  
 Defensins 87  
 Defined media 36  
 Dehydrated media 37  
 Delayed type hypersensitivity (DTH) 154  
 Delta agent 557  
 Dematiaceous fungus 597  
 Demonstration of fungal antigen 614  
 Demonstration of serum antibodies 278  
 Demonstration of virus-induced CPEs in the cells 453  
 Dengue hemorrhagic fever 542  
 Dengue shock syndrome 542  
 Dengue virus 542  
 Deoxyribonucleases 186  
*Demacenter andersoni* 336, 412  
*Demacenter variabilis* 336, 412  
*Dermatophilus* 398  
 Dermatophytid (id) 598  
 Dermatophytoses 598  
 Designation of influenza viruses 508  
 Detection of endotoxin in medical solutions 81  
 Detection of fungal cell wall markers 596  
 Detection of fungal metabolites 596  
 Detection of gonococcal antigen 206  
 Detection of *Haemophilus influenzae* capsular antigen 326  
 Deuteromycetes 593  
 Dharmender's antigen 368  
 Diagnosis of allergic bronchopulmonary aspergillosis 611  
 Diagnosis of hospital-acquired infections 632  
 Diagnosis of invasive aspergillosis 596  
 Diagnosis of phaeohyphomycosis 601  
 Diagnosis of rubella 584  
 Diagnostic tests for leptospirosis (Table 44-7) 385  
 Diagnostic tests for syphilis (Table 44-5) 378  
 Dick test 186  
 Dienes phenomenon 267  
 Diene's staining 387  
 Dienes typing 267  
 Dieterle's silver stain 402  
 Differences between acute glomerulonephritis and acute rheumatic fever (Table 24-3) 189  
 Differences between antigenic shift and antigenic drift (Table 61-3) 507  
 Differences between cell-mediated and humoral immunity (Table 11-3) 89  
 Differences between contact and tuberculin-type hypersensitivity (Table 19-3) 155  
 Differences between coxsackie A and coxsackie B viruses (Table 60-4) 502  
 Differences between electron microscope and light microscope (Table 2-2) 12  
 Differences between endotoxins and exotoxins (Table 10-10) 80  
 Differences between enteroviruses and rhinoviruses (Table 60-5) 503  
 Differences between Gram-positive and Gram-negative bacteria cell wall (Table 2-3) 16  
 Differences between group I and II antigens of *Escherichia coli* (Table 31-4) 254  
 Differences between growth and biochemical properties of important *Campylobacter* and *Helicobacter* species (Table 36-5) 311  
 Differences between helper T cells (CD4) and cytotoxic T (CD8) cells (Table 16-3) 127  
 Differences between HSV-1 and HSV-2 (Table 57-3) 477  
 Differences between human papillomaviruses and human polyomaviruses (Table 56-3) 472  
 Differences between immediate and delayed hypersensitivities (Table 19-1) 149  
 Differences between innate and acquired immunity (Table 11-1) 87  
 Differences between mutational and transferable drug resistance (Table 9-4) 66  
 Differences between orthomyxoviruses and paramyxoviruses (Table 61-1) 505  
 Differences between passive and active immunity (Table 11-4) 89  
 Differences between prions and viruses (Table 69-2) 579  
 Differences between prokaryotic and eukaryotic cells (Table 2-1) 10  
 Differences between *Staphylococcus aureus*, *Staphylococcus epidermidis*, and *Staphylococcus saprophyticus* (Table 23-7) 182  
 Differences between sterilization and disinfection (Table 3-4) 30  
 Differences between street and fixed rabies viruses (Table 64-1) 530  
 Differences between T cells and B cells (Table 16-1) 125  
 Differences between treponemes and leptospire (Table 44-6) 384  
 Differences between variola virus and vaccinia virus (Table 55-2) 467  
 Different modes of transmission (Table 10-3) 75  
 Differential characteristics of *Bordetella* species (Table 39-3) 335  
 Differential characteristics of Classical cholera and Eltor vibrios (Table 35-4) 297  
 Differential coliform count 625  
 Differential features of *Brucella* species (Table 40-2) 339  
 Differential features of Chlamydia species causing human diseases (Table 49-2) 419  
 Differential features of important *Haemophilus*, *Pasteurella*, and *Actinobacillus* species (Table 38-5) 328  
 Differential features of *Mycobacterium tuberculosis* and *Mycobacterium bovis* (Table 41-4) 353  
 Differential features of various forms of leprosy (Table 43-2) 366  
 Differential features of various strains of *Mycobacterium tuberculosis* (Table 41-2) 347  
 Differential properties of important atypical *Mycobacterium* species (Table 42-2) 360  
 Differential stains 13  
 Differentiating features between *Bacillus anthracis* and *Bacillus cereus* (Table 28-3) 230  
 Differentiating features of coagulase and clumping factors (Table 23-4) 176  
 Differentiating features of hepatitis A (Table 66-4) 557  
 Differentiating features of *Vibrio parahaemolyticus* and *Vibrio alginolyticus* (Table 35-5) 303  
 Differentiating features of *Vibrio*, *Aeromonas*, and *Plesiomonas* based on utilization of amino acids (Table 35-6) 304  
 Differentiating features of *Yersinia* species (Table 34-4) 292  
 Differentiation between biotypes of *Yersinia pestis* (Table 34-3) 290  
 Differentiation of genera of the tribe Proteaceae (Table 31-11) 265  
 Differentiation of *Shigella* species (Table 33-2) 282  
 Diffusely adherent *Escherichia coli* 257  
 Di-George syndrome 123  
 Dilution tests 70  
 Dimorphic fungi 593  
 Diphtheria exotoxin 215  
 Diphtheria toxin 215  
 Diphtheria toxoid 219  
 Diploid cell strains 456  
 Direct Coombs (antiglobulin) test 108  
 Direct detection of rickettsial antigen 412  
 Direct detection of viruses 454  
 Direct immunofluorescence test 111  
 Direct template theory 135  
 Directly observed therapy (DOT) 356  
 Disc diffusion tests 68  
 Discovery of important bacterial agents causing human diseases (Table 1-1) 6  
 Diseases associated with Bunyaviridae (Table 65-2) 546  
 Diseases associated with hepatitis viruses (Table 66-2) 547  
 Diseases associated with influenza virus infection (Table 61-2) 505

- Diseases associated with paramyxoviruses (Table 62-1) 514
- Diseases associated with reoviruses (Table 63-1) 524
- Diseases associated with various serotypes of adenoviruses (Table 58-2) 491
- Diseases caused by fungal toxins 595
- Disinfectants  
activities of (Table 3-5) 33  
testing of 33  
types of 33
- Disinfection 24, 29
- Disposal of biomedical wastes 636
- Disseminated candidiasis 609
- Disseminated cryptococcosis 607
- Disseminated gonococcal infections 204
- Disseminated nocardiosis 397
- Disseminated zygomycosis 615
- Distinguishing features of *Corynebacterium diphtheriae* and diphtheroids (Table 27-4) 221
- Distinguishing features of pneumococci and viridans streptococci (Table 25-2) 199
- Distinguishing features of *Staphylococcus*, *Micrococcus*, and *Planococcus* (Table 23-1) 173
- Distinguishing features of *Streptococcus* and *Enterococcus* (Table 24-5) 192
- DNA sequencing 56
- Dog tick 412
- Domestic dogs 415
- Donovan bodies 400
- Drug reactions 154
- Drug-induced hemolysis 152
- DTP vaccines 219
- Duckering 224
- Dumb rabies 532
- Duvenhage virus 535
- Dyes 32
- E**
- 
- “E” strain of *Rickettsia prowazekii* 410
- Eastern equine encephalitis virus 538
- EBV infection in immunocompromised 483
- EBV-induced tumors 482
- EBV-negative cases of infections  
mononucleosis 482
- EBV-specific antibody tests 484
- ECHO viruses 502
- Ecotrix infection 599
- Eczema herpeticum 476
- Eczema vaccinata 467
- Edema factor 224
- Edwardsiella* 261
- Edwardsiella tarda* 261
- Effector cells in anaphylaxis 150
- Effects of complement 116
- Effects of mutations 49
- Ehrlichia chaffeensis* 414
- Ehrlichia ewingii* 414
- Ehrlichia phagocytophila* 414
- Ehrlichia sennetsu* 414
- Eijkman test 625
- Eikenella corrodens* 328
- Electron microscopy 11
- Elek’s gel precipitation test 218
- Elek’s precipitation test 105
- Elementary body (EB) 418
- ELISA in HIV (Table 68-4) 574
- ELISPOT assay 113
- EMJH media 384
- Endemic Burkitt’s lymphoma 482
- Endemic meningitis 209
- Endemic or flea-borne murine typhus 408
- Endemic relapsing fever 378
- Endemic shigellosis 284
- Endemic syphilis 378
- Endemic tick-borne relapsing fever 379
- Endogenous retroviruses 565
- Endotoxic shock 81
- Endotoxin-mediated toxicity mechanism of (Table 10-8) 81
- Endotoxins 282
- Enriched media 36
- Enrichment media 36
- Enteric adenovirus infection 491
- Enteric cytopathogenic human orphan viruses (ECHO viruses) 502
- Enterobacter aerogenes* 263
- Enterobacter cloacae* 263
- Enterobacter sakazakii* 263
- Enterobacter* species differentiation of (Table 31-10) 264
- Enterobacteriaceae important properties of (Table 31-2) 252
- Enterococcus* 192
- Enterococcus durans* 193
- Enterococcus faecium* 193
- Enterotoxin 176
- Enterovirus 503
- Enteroviruses 496
- Enveloped viruses 430, 448
- Enzyme Immunoassays 112
- Eosinophilic chemotactic factors of anaphylaxis 150
- Eosinophilic inclusion bodies 465
- EPI’s immunization schedule (Table 79-2) 638
- Epidemic keratoconjunctivitis 491
- Epidemic louse-borne relapsing fever 379
- Epidemic or louse-borne typhus 408
- Epidemic typhus 409
- Epidemics of viral infection 447
- Epidemiological features of hepatitis viruses (Table 66-5) 559
- Epidemiology of *Ehrlichia* species causing human diseases (Table 48-5) 415
- Epidemiology of hospital-acquired infection 629
- Epidemiology of *Neisseria meningitidis* serogroups (Table 26-5) 210
- Epidemiology of *Rickettsia* species causing human diseases (Table 48-4) 414
- Epidermophyton floccosum* 598
- Epidermophyton* infection 599
- Epididymo-orchitis 520
- Epiglottitis 324
- Epitope spreading 157
- Epitopes 91
- Epsilometer test 71
- Epstein-Barr early antigens 485
- Epstein-Barr nuclear antigen (EBNA) 482
- Epstein-Barr virus (EBV) 481
- ERS tests 575
- Erwinia* 268
- Erwinia herbicola* 268
- Erysipelas 188
- Erysipelothrix rhusiopathiae* 400
- Erythema arthriticum epidemicum 401
- Erythema infectiosum 494
- Erythema migrans 381
- Erythema multiforme 388
- ESBL strains of *Klebsiella pneumoniae* 263
- ESBLs-producing strains of *Morganella morganii* 268
- Eschar 225
- Escherichia* 252
- Escherichia coli* 252  
enterohemorrhagic 257  
enteroinvasive 257  
enteropathogenic 256  
enterotoxigenic 257  
identifying features of (Box 31-1) 259  
virulence factors of (Table 31-5) 255
- Escherichia coli* O157:H7 261
- Ethyl alcohol 31
- Ethylene oxide 32
- Eumycetoma 601
- European blastomycosis 606
- Ewing’s classification of the family Enterobacteriaceae (Table 31-1) 252
- Examples of VAPs (Table 50-4) 434
- Examples of viral receptors in host cells (Table 50-5) 435
- Exfoliative toxin 177
- Exophiala jeanselmei* 601
- Exotoxins 80
- Expanded Programme on Immunization (EPI) 638
- Explant culture 456
- Extended-spectrum antibiotics 61
- Extrachromosomal DNA substances 49
- Extrapulmonary tuberculosis 349
- F**
- 
- F antigen 196, 271
- F factor 49
- F plasmid 49
- Factors affecting hospital-acquired infection 629
- Factors affecting production of antibodies 136
- Factors determining the colonization of microbes 619
- Farcy 318
- Fatal familial insomnia 580
- Favus 599
- Features of the organisms causing superficial mycoses (Table 72-1) 598
- Fecal antigen test 310
- Fecal streptococci 624
- Feces culture 277
- Feline spongiform encephalopathy 578, 581
- Fernandez reaction 368
- Fetcher’s medium 382
- Fifth disease 494
- Filamentous hemagglutinin 331
- Filamentous *Nocardia* 396
- Fildes technique 238
- Filobasidiella neoformans* 606
- First-line antitubercular drugs 356
- Fitz-Hugh and Curtis syndrome 204
- Fixed virus 530
- Flagella 19
- Flaming 27
- Flash method 25
- Flavobacterium meningosepticum* 400

- Flea index 289  
 Flocculation reaction 376  
 Flocculation test 104  
 Fluorescence microscopy 11  
 Fluorescent treponemal antibody absorption (FTA-Abs) tests 376  
 Flury and Kelev strains 530  
*Fonsecaea compactum* 601  
*Fonsecaea pedrosoi* 601  
 Fontana's method of staining 382  
 Food-borne botulism 243  
 Footpads of mice 362  
 Formaldehyde 32  
 Formalin gas 32  
 Forssman antibodies 484  
 Forssman antigen 14, 484  
 Forssman-type antibodies 109  
 Frame-shift mutation 48  
 Francis' blood dextrose cystine agar 335  
*Francisella tularensis* 335  
 Frei's skin test 423  
 Friedlander's bacillus 262  
 Fulminant hepatic failure 552  
 Functions of resident flora 619  
 Fungal agents of zygomycosis 612  
 Fungal colonization of the oropharynx 620  
 Fungal colonization of the skin surface 622  
 Fungal toxins 595  
 Fungi imperfecti 593  
 Furious rabies 531  
*Fusarium solani* infection 615  
*Fusobacterium fusiforme* 381  
*Fusobacterium necrophorum* 248  
*Fusobacterium nucleatum* 248
- G**
- Gamma radiation 28  
 Gamma-hemolytic streptococci 183  
 Ganjam virus 545  
 Gardner and Venkatraman classification of *Vibrio cholerae* 296  
*Gardnerella vaginalis* 406  
 Gas gangrene 234  
 Gas pack system 40  
 Gastroenteritis caused by *Escherichia coli* (Table 31-6) 256  
 Gastrointestinal anthrax 226  
 Gastrointestinal tract candidiasis 609  
 Gastrointestinal tuberculosis 350  
 Gastrointestinal zygomycosis 612  
 Gene therapy 60  
 General paralysis of insane 374  
 General properties of viruses 429  
 Generalized tetanus 239  
 Generation time 21  
 Genetic classification 46  
 Genetic engineering and molecular methods 55  
 Genetic probes 45  
 Genital chlamydia 422  
 Genital herpes 476  
 Genital *Mycoplasma* species 391  
 Genitourinary candidiasis 609  
 Genitourinary tuberculosis 349  
 Genotypic techniques 45  
 Genus *Coxiella* 415  
 Germ theory of disease 4
- Germ tube 610  
 Ghon's focus 348  
 Gimenez stain 407  
 Glandular fever 335  
 Glandular tularemia 336  
 Gloves and sock syndrome 494  
 Glutaraldehyde 32  
 Gonococcal pharyngitis 204  
 Gonococcal vulvovaginitis 204  
 Gonorrhoea 203  
*Gordonia* and *Tsakamurella* 398  
 Grading of ZN-stained smears for lepra bacilli (Table 43-3) 368  
 Graft-versus-host disease (GVHD) 145  
 Gram's stain 13  
 Gram-negative cell wall 14  
 Gram-positive cell wall 14  
 Granuloma inguinale 400  
 Griffith typing 184  
 Group C streptococci 191  
 Group F streptococci 192  
 Group G streptococci 192  
 Growth rate during different phases of bacterial growth curve (Table 2-5) 22  
 Guarnieri bodies 444  
 Guillain-Barre syndrome 157, 307, 509  
 Gumma 378
- H**
- H5N1 flu 510  
 H5N1 infection 510  
 HACEK group of bacteria 328  
*Haemophilus aegyptius* 327  
*Haemophilus aphrophilus* 327  
*Haemophilus ducreyi* 326  
*Haemophilus haemolyticus* 327  
*Haemophilus influenzae* 321  
*Haemophilus influenzae* type b (Hib) vaccines 323  
*Haemophilus parainfluenzae* 327  
*Haemophilus vaginalis* 327  
*Hafnia alvei* 264  
 Hair perforation test 599  
 Halophilic vibrio 302  
 Hantann virus 544  
 Hantavirus 544  
 Hantavirus pulmonary syndrome 544  
 Haptens 93  
 Hard ticks 336, 381  
 Hashimoto's thyroiditis 158  
 Haverhill's fever 401  
 Heaf test 355  
 Heat 25  
 Helical nucleocapsids 432  
 Helical viruses 430  
*Helicobacter hepaticus* 311  
*Helicobacter mustelae* 311  
*Helicobacter pylori* 308  
*Helicobacter*-like organisms 311  
 Helper T cells 135  
 Helper T lymphocytes 126  
 Hemadsorption test 390  
 Hemagglutination test 108  
 Hemolysins 187  
 Hemolytic disease of the newborn 169  
 Hemolytic uremic syndrome (HUS) 252, 256, 258  
 Hemoptysis 403
- Hemorrhagic colitis 258  
 Hemorrhagic cystitis 491  
 Hemorrhagic fever 544  
 Hendra virus 522  
 Hepatitis 547  
 Hepatitis A virus 547  
 Hepatitis B core antigen 551  
 Hepatitis B e antigen 550  
 Hepatitis B immunoglobulin 554  
 Hepatitis B subunit vaccine 638  
 Hepatitis B surface antigen 550  
 Hepatitis B virus 550  
 Hepatitis C virus 555  
 Hepatitis D virus 557  
 Hepatitis E virus 558  
 Hepatitis G virus 559  
 Hepatocellular carcinoma 555  
 Hepatosplenic candidiasis 609  
 Herd immunity 89  
 Hereditary angioedema 146  
 Herpangina 501  
 Herpes encephalitis 476  
 Herpes labialis 476  
 Herpes simplex virus (HSV)-1 474  
 Herpes zoster 480  
 Herpesvirus simiae 479  
 Herpesviruses 473  
 Herpetic whitlow 476  
 Heterologous interference 457  
 Heterophile agglutination test 107  
 Heterophile antibody test 483  
 Heterophile antigens 92  
 Hib conjugate vaccine 326  
 Hib meningitis 323  
 Hib vaccines 326  
 High-frequency recombination (Hfr) 53  
 High-frequency sound (sonic) waves 29  
 Highly active antiretroviral therapy (HAART) (Box 68-2) 576  
 Hippurate hydrolysis test 191  
 Histamine 150  
 Histocompatibility antigens 92  
 Histoplasmin skin test 605  
 Histoplasmosis 604  
 History of microbiology 3  
 HIV genes and their products (Table 68-1) 567  
 HIV replication 567  
 HIV vaccine 577  
 HIV virus 566  
 HLA association with autoimmune diseases 160  
 HLA complex 131  
 HLA typing 133  
 Holder method 25  
 Horizontal transmission 76  
 Horror autotoxicus 156  
 Hospital strains of *Staphylococcus aureus* (Box 23-1) 178  
 Hospital surveillance 632  
 Hospital-acquired *Escherichia coli* 261  
 Hospital-acquired infection 629  
 Hospital-acquired *Staphylococcus aureus* infections 178  
 Hosts and pathogenesis of prion-related slow diseases in animals (Table 69-4) 581  
 Hot-air oven 27  
 HSV-2 infections 476  
 Hugh-Leifson's method 19

- Human adenoviruses 490
- Human anatomical waste 634
- Human B cell lymphotropic virus 473
- Human blood and body fluid waste 634
- Human body louse 380
- Human erythrocyte antigens 92
- Human granulocytic ehrlichiosis 414
- Human herpesvirus 1 473
- Human herpesvirus 2 473
- Human herpesvirus 3 473
- Human herpesvirus 4 473, 481
- Human herpesvirus 5 473, 485
- Human herpesvirus 6 (HSV-6) 487
- Human herpesvirus 7 (HSV-7) 488
- Human herpesvirus 8 (HSV-8) 488
- Human immunodeficiency virus 566
- Human infections caused by *Actinobacillus* species (Table 38-4) 328
- Human infections caused by actinomycetes (Table 46-1) 393
- Human infections caused by anaerobic Gram-positive and Gram-negative bacilli (Table 30-1) 248
- Human infections caused by atypical *Mycobacterium* species (Table 42-1) 358
- Human infections caused by *Bacillus* species (Table 28-1) 222
- Human infections caused by *Bartonella* species (Table 47-3) 405
- Human infections caused by *Bordetella* species (Table 39-1) 330
- Human infections caused by *Bordetella* species (Table 39-1) thumbprint appearance 330
- Human infections caused by B19 virus (Table 59-1) 493
- Human infections caused by *Brucella* species (Table 40-1) 338
- Human infections caused by *Campylobacter* species (Table 36-1) 305
- Human infections caused by *Chlamydia* species (Table 49-1) 418
- Human infections caused by *Clostridium* species (Table 29-1) 231
- Human infections caused by *Corynebacterium* species (Table 27-1) 213
- Human infections caused by Enterobacteriaceae (Table 31-3) 252
- Human infections caused by *Haemophilus* species (Table 38-1) 321
- Human infections caused by *Helicobacter* species (Table 36-3) 308
- Human infections caused by human herpesviruses (Table 57-2) 474
- Human infections caused by most common spirochetes (Table 44-1) 345
- Human infections caused by most common spirochetes (Table 44-1) translatory motion 371
- Human infections caused by *Mycoplasma* and *Ureaplasma* species (Table 45-1) 386
- Human infections caused by papovaviruses (Table 56-1) 469
- Human infections caused by *Pasteurella* species (Table 38-3) 327
- Human infections caused by picornaviruses (Table 60-1) 497
- Human infections caused by Pox viruses (Table 55-1) 463
- Human infections caused by *Pseudomonas* and other genera of the family Pseudomonadaceae (Table 37-1) 313
- Human infections caused by Rickettsia, Orientia, Ehrlichia, and Coxiella species (Table 48-1) 407
- Human infections caused by *Salmonella* spp. (Table 32-1) 269
- Human infections caused by *Shigella* species (Table 33-1) 281
- Human infections caused by *Staphylococcus*, *Micrococcus*, and *Stomatococcus* (Table 23-2) 173
- Human infections caused by *Streptococcus* and *Enterococcus* (Table 24-1) 183
- Human infections caused by *Vibrio* species (Table 35-1) 294
- Human infections caused by *Yersinia* species (Table 34-1) 286
- Human metapneumovirus 522
- Human MHC gene products (Table 16-5) 132
- Human monocytic ehrlichiosis 141
- Human orthoreovirus infection 526
- Human papillomaviruses 469
- Human parainfluenza viruses (HPIVs) 517
- Human rabies immunoglobulin 639
- Human tetanus immunoglobulin 639
- Human T-lymphotropic viruses 560, 563
- Humoral immunity 349, 445
- tests for detection of 138
- Hyaluronidase 176, 186
- Hybridization
- types of 56
- Hybridization probes 56
- Hybridoma cells 137
- Hydrogen bonding 101
- Hydrophobia 532
- Hydrops fetalis 494
- Hyper-IgM syndrome 144
- Hypersensitivity reaction 149
- 
- Iatrogenic infection 73
- ICRC bacillus 362
- ICRC vaccines 370
- Icteric leptospirosis 383
- Identification of bacteria 41
- Identification of leptospira isolates 384
- Identifying features of *Actinomyces* species (Box 46-1) 395
- Identifying features of *Bordetella pertussis* (Box 39-1) 334
- Identifying features of *Brucella* spp. (Box 40-1) 342
- Identifying features of *Campylobacter* species (Box 36-1) 308
- Identifying features of *Corynebacterium diphtheria* (Box 27-1) 218
- Identifying features of *Haemophilus influenzae* (Box 38-1) 325
- Identifying features of *Helicobacter pylori* (Box 36-2) 310
- Identifying features of *Mycobacterium tuberculosis* (Box 41-1) 353
- Identifying features of *Mycoplasma* (Box 45-1) 390
- Identifying features of *Pseudomonas aeruginosa* (Box 37-1) 317
- Identifying features of *Salmonella* Typhi (Box 32-1) 277
- Identifying features of *Shigella* species (Box 33-1) 285
- Identifying features of *Staphylococcus aureus* (Box 23-2) 180
- Identifying features of *Streptococcus pneumoniae* (Box 25-1) 199
- Identifying features of *Vibrio cholerae* (Box 35-1) 301
- Identifying features of *Yersinia pestis* (Box 34-1) 290
- Idiopathic thrombocytopenic purpura 159
- IgM FTA-Abs test 377
- Immune adherence test 110
- Immune surveillance 128
- Immune tolerance
- types of 142
- Immunity
- types of 85
- Immunity in syphilis 373
- Immunity in viral infections 445
- Immunity to HCV 555
- Immunity to influenza 509
- Immunization for prevention of neonatal tetanus 242
- Immunization schedule 638
- Immunodeficiency diseases 147
- Immunodeficiency syndromes (Table 18-1) 147
- Immunodiffusion reactions
- types of 104
- Immunoelectron microscopy 12
- Immunoelectronmicroscopic tests 115
- Immunoelectrophoresis 105
- Immunogenetics of leprosy 364
- Immunoglobulin A 98
- Immunoglobulin D 99
- Immunoglobulin E 99
- Immunoglobulin G 96
- Immunoglobulin M 97
- Immunoglobulins
- structure of 94
- Immunological paralysis 136
- Immunological surveillance 138
- Immunological tolerance 142
- Immunomodulatory drugs 369
- Immunopathogenesis of viral infections (Table 51-4) 445
- Immunoprophylaxis in rabies (Table 64-2) 534
- Immunosuppressive agents 137
- Important bacterial surface virulence factors (Table 10-1) 73
- Important biochemical characters of common streptococci (Table 24-4) 192
- Important causative agents of mycetoma (Table 72-5) 601
- Important properties of arboviruses 536
- Important properties of roboviruses (Box 65-1) 538
- Impregnation stains 12
- IMViC tests 253
- Incineration 27
- Inclusion bodies 444
- Inclusion bodies produced in viral infections (Table 51-3) 444
- Inclusion conjunctivitis in the newborns 422
- Incomplete viruses 435
- Incubation periods of common DNA viruses (Table 51-5) 446

- Incubation periods of common RNA viruses (Table 51-6) 447
- Indian classification of leprosy 364
- Indian ink preparation of cerebrospinal fluid
- Indian pangolin 363
- Indicator diseases of AIDS (Table 68-3) 571
- Indirect complement fixation test 110
- Indirect ELISA 112
- Indirect hemagglutination (IHA) test 108
- Indirect immunofluorescence test 111
- Indirect template theory 135
- Individual immunity 85
- Indole test 42
- Infant botulism 244
- Infant mouse test 260
- Infant pneumonia 421
- Infantile agammaglobulinemia 143
- Infection control committee 632
- Infection mononucleosis 482
- Infections caused by encapsulated *Haemophilus influenzae* 324
- Infectious dose (ID<sub>50</sub>) 72
- Infectious mononucleosis 482
- Infective endocarditis 328
- Inflammatory response 87
- Inflammatory staphylococcal diseases 177
- Influenza epidemics and pandemics 510
- Influenza vaccines 637
- Influenza viruses 505
- Infrared radiations 29
- Inhalational anthrax 226
- Innate immunity 85
- Instructional theory 7
- Instructive theory 135
- Interference microscopy 11
- Interferon 452
- Intermittent sterilization 27
- Interpretation of common serological markers in HBV infection (Table 66-3) 554
- Interpretation of laboratory tests in diagnosis of HIV (Table 68-6) 576
- Intracellular pathogens (Table 10-7) 79
- Intracytoplasmic inclusion bodies 17
- Introduction to Mycology 593
- Inulin fermentation test 199
- In-use (Kelsey and Maurer) test 33
- Invasive aspergillosis 611
- Iodine tablets 31
- Iodine tincture 31
- Ionizing radiations 28
- Isoantigens 92
- Isopropyl alcohol 31
- Ixodes capillaris* 415
- Ixodes pacificus* 415
- Ixodes ricinus* 415
- Ixodes* species 415
- Izumi fever 293
- J**
- Japanese encephalitis virus 539
- Jarish-Herxheimer reaction 377
- JC virus 469, 472, 582
- Jellison type A (*Francisella tularensis* biovar tularensis) 335
- Jellison type B (*Francisella tularensis* biovar palaeartica) 335
- Jeryl-Lynn strain of mumps virus 521
- Job's syndrome 146
- Joseph Lister 5
- Jumping genes 50
- K**
- Kahn test 104
- Kahn's tube flocculation test 375
- Kanagawa phenomenon 303
- Kaposi's sarcoma-related virus 473
- Kauffman-White classification of Salmonella (Table 32-4) 276
- Kauffman-White scheme 275
- Kazan strain 379
- Kemerovo virus 524
- Killed attenuated vaccines 637
- Killed cholera vaccines 302
- Kingella denitrificans* 329
- Kingella indologenes* 329
- Kingella kingae* 329
- Kissing disease 482
- Klebsiella ornithinolytica* 262
- Klebsiella oxytoca* 263
- Klebsiella ozaenae* 263
- Klebsiella planticola* 262
- Klebsiella pneumoniae* 262
- diagnosis of infection 260
- Klebsiella rhinoscleromatis* 263
- Klebsiella* species
- important properties used for differentiation of (Table 31-9) 263
- Klebsiella terrigena* 262
- Kligler's iron agar (KIA) 43
- Koch's phenomenon 6, 349
- Koch's postulates 5
- KOH preparation of the skin 597
- Koplik's spot 515
- Korean chipmunks 363
- Korthoff's medium 382
- Koser's citrate medium 43
- Kotonkan viruses 529, 535
- Kovac's reagent 42
- Kristensen's biotyping 276
- Kuru 578, 580
- Kyasanur Forest disease 534, 544
- L**
- L forms 402
- Laboratory acquired infections 634
- Laboratory diagnosis for viral diseases 453
- Laboratory diagnosis of Bunyaviridae 545
- Laboratory diagnosis of chlamydial infection 422
- Laboratory diagnosis of
- chromoblastomycosis 601
- Laboratory diagnosis of coccidioidomycosis 603
- Laboratory diagnosis of Colorado tick fever 525
- Laboratory diagnosis of coxsackievirus infection 502
- Laboratory diagnosis of cryptococcal infection 607
- Laboratory diagnosis of echovirus infection 502
- Laboratory diagnosis of fungal infections 595
- Laboratory diagnosis of HDV infection 558
- Laboratory diagnosis of HIV 573
- Laboratory diagnosis of influenza virus infection (Table 61-6) 512
- Laboratory diagnosis of invasive aspergillosis 611
- Laboratory diagnosis of listeriosis 399
- Laboratory diagnosis of rabies in dogs 533
- Laboratory diagnosis of rhinosporidiosis 602
- Laboratory diagnosis of sporotrichosis 602
- Laboratory diagnosis of tinea nigra 597
- Laboratory monitoring of the status of HIV infection 575
- Laboratory procedures for diagnosis of viral infections (Table 53-1) 454
- Laboratory tests for diagnosis of herpes simplex virus infections (Table 57-4) 478
- Lagos bat virus 535
- Lancefield classification 183
- Lassa fever 587
- Lassa virus 587
- Latency of adenoviruses 490
- Latent infections 73
- Latex agglutination test 108
- Lattice hypothesis 103
- Lawn culture 38
- Lebombo virus 524
- Lectin pathway of complement activation 119
- Legionella pneumophila* 393
- Legionella pneumophila* 401
- Legionellosis 402
- Legionnaire's disease 403
- Lepra type I reaction 366
- Lepra type II reactions 366
- Lepromatous leprosy 364
- Lepromin antigen 368
- Lepromin skin test 368
- Lepromin test 368
- Leprosy 364
- Leprous reactions 366
- Leptospira interrogans* complex 382
- Leptotrombidium deliense* 413
- Lethal dose (LD<sub>50</sub>) 72
- Lethal factor 224
- Lethal toxin 332
- Leukocidins 177
- Leukocyte adhesion deficiency 146
- Leukosis sarcoma viruses of other animals 563
- Levaditi's method staining 372
- Levinthal's agar 322
- Levinthal-Cole-Lille (LCL) inclusion bodies 425
- L-forms of bacteria 17
- Limulus lysate test 81
- Lipid A 16
- Lipopolysaccharides (LPS) 16
- Lipovnik virus 524
- Liquid culture 39
- Listeria monocytogenes* 399
- Live attenuated oral polio vaccine 500
- Live attenuated organisms 637
- Live oral cholera vaccine 302
- Lobo disease 604
- Localized tetanus 240
- Lone star tick 415
- Louis Pasteur—Father of Microbiology 4
- Louse-borne infection 380
- LPS antigens of the gonococci 206
- Lucio phenomenon 366
- Lutz-Splendore-Almeida disease 604
- Lyme disease 381
- Lymph nodes



functions of 123  
 Lymphatic circulatory system 124  
 Lymphocytic choriomeningitis viruses 587  
 Lyophilization 29  
 Lysogenic cycle 460  
 Lytic cycle 461

## M

Machupo virus 586  
 Macrophage migration inhibition factor (MIF) 141  
 Macrophage-like cells 129  
 Macrophages  
   functions 129  
   important features of (Table 16-4) 130  
 Major histocompatibility complex (MHC) 131  
 Mallein test 319  
 Malta fever 338  
 Manifestations of the viral diseases 442  
 Mannan antigen detection 596  
 Mannitol fermentation test 285  
 Mantoux test 355  
 Marburg infection 586  
 McCrady probability table (Table 76-3) 625  
 McFaydean capsule stain 18  
 McFadyean's reaction 228  
 McIntosh-Fildes anaerobic jar 40  
 Measles virus 514  
 Mechanism and manifestations of hypersensitivity reactions (Table 19-2) 151  
 Mechanism of DTH 154  
 Mechanism of immune-complex hypersensitivity 153  
 Mechanisms of antiviral drugs (Table 52-1) 450  
 Mechanisms of cytopathogenesis of viral infections (Table 51-2) 443  
 Mechanisms of HIV escape from the immune system of the host (Table 68-2) 570  
 Mechanisms of tolerance 142, 156  
 Mediators of active immunity 88  
 Mediators of inflammatory reactions 87  
 Mediterranean fever 338  
 Melioidosis 319  
 Memory T cells 127  
 Meningococcal endotoxin 208  
 Meningococcal meningitis 209  
 Meningococcal pneumonia 209  
 Meningococemia 209  
 Metachromatic granules 17  
 Methicillin-resistant *Staphylococcus aureus* 181  
 Method of production of monoclonal antibodies 137  
 Methods of culture 38  
 Methods of detection of LT and ST of *Escherichia coli* (Table 31-7) 260  
 Methods of water analysis 625  
 Methods used to size, synthesize, and sequence DNA 56  
 Methyl red (MR) test 44  
 Methylene blue test 627  
 MHC associations with autoimmune diseases (Table 20-2) 160  
 Microbial diseases transmitted by insects (Table 10-2) 74  
 Microbial flora in the vagina 621  
 Microbicide 24

Micrococcus 182  
 Microscopic agglutination test (MAT) 384  
 Microscopic slide agglutination test 385  
*Microsporium* 599  
   *Microsporium audouinii* 598  
   *Microsporium equinus* 599  
   *Microsporium gypseum* 598  
   *Microsporium* infection 599  
 Microwave treatment 636  
 Mid-borderline leprosy 365  
 Milk ring test 343  
 Milk-borne diseases (Table 76-4) 627  
 Milker's node 467  
 Minimum bactericidal concentration (MBC) 71  
 Minimum inhibitory concentration (MIC) 70  
 Missense mutation 48  
 Mitsuda lepromin 368  
 Mitsuda reaction 368  
 MMR 517  
 MMR vaccine 639  
*Mobiluncus* species 248  
 Moist heat sterilization 27  
   types and uses of (Table 3-1) 26  
 Mokola virus 535  
 Molecular mimicry 157  
 Molluscum bodies 444, 468  
 Molluscum contagiosum 468  
 Monkeypox 467  
 Monoclonal antibodies 137  
 Monomeric IgM 98  
 Monospot test 484  
 Monsur's taurocholate tellurite peptone water 295  
*Moraxella atlanta* 319  
*Moraxella lacunata* 319  
*Moraxella nonliquefaciens* 319  
*Moraxella osloensis* 319  
*Moraxella phenylpyruvica* 319  
*Morganella* 267  
*Morganella morganii* 267  
 Morphology of viruses 429  
 Morulae 415  
 Mouse footpad model 362  
 Mouse mammary tumor virus 565  
 Mouse mite 413  
 Mouse pneumonitis 420  
 Much's granules 346  
 Mucocutaneous candidiasis 609  
 Mucosa-associated lymphoid tissues (MALT) 123  
 Multidrug resistant (MDR) mycobacteria 354  
 Multidrug-resistant tuberculosis (MDR-TB) 356  
 Multiple puncture tests 355  
 Multiplex PCR 58  
 Mumps 519  
 Mumps virus 519  
 Murine toxins 288  
 Murray valley encephalitis virus 539  
*Mus musculus* 413  
 Mutational resistance 66  
 Mutations 48  
 Myasthenia gravis 159  
 Mycetoma 600  
 Mycobacteria drug susceptibility testing 354  
 Mycobacteria other than tubercle bacilli (MOTT) 358  
*Mycobacterium abscessus* 358  
*Mycobacterium africanum* 345

*Mycobacterium avium* complex (MAC) 359  
*Mycobacterium avium* 359  
*Mycobacterium avium-intracellulare* 358  
*Mycobacterium chelonae* 358  
*Mycobacterium fortuitum* 358  
*Mycobacterium gordonae* 359  
*Mycobacterium habana* vaccine 370  
*Mycobacterium intracellulare* 359  
*Mycobacterium leprae* 362  
*Mycobacterium lepraemurium* 370  
*Mycobacterium marinum* 359  
*Mycobacterium microti* 345  
*Mycobacterium nonchromogenicum* 359  
*Mycobacterium phlei* 360  
*Mycobacterium scrofulaceum* 359  
*Mycobacterium simiae* 359  
*Mycobacterium smegmatis* 360  
*Mycobacterium szulgai* 359  
*Mycobacterium terrae* 359  
*Mycobacterium triviale* 359  
*Mycobacterium tuberculosis* 346  
*Mycobacterium tufo* 370  
*Mycobacterium ulcerans* 359  
*Mycobacterium w* vaccine 370  
*Mycobacterium xenopi* 359  
 Mycolic acid 346  
*Mycoplasma agalactiae* 387  
*Mycoplasma fermentans* 386  
*Mycoplasma genitalia* 387  
*Mycoplasma genitalis* 391  
*Mycoplasma genitalium* 386  
*Mycoplasma hominis* 386, 391  
*Mycoplasma orale* 386  
*Mycoplasma pirum* 386  
*Mycoplasma pneumoniae* 386  
*Mycoplasma salivarium* 386  
 Mycotic mycetomas 601  
 Mycotoxicosis 595  
 Myeloma proteins 100

## N

Nagler reaction 236  
 Nairobi sheep disease virus 544  
 Nairovirus 544  
 NAP differentiation test 354  
 National immunization schedule 638  
 Natural killer (NK) cells 130  
 Natural selection theory 136  
 Natural tolerance 142  
 Natural water bacteria 623  
 Necrotizing enteritis 235  
 Necrotizing fasciitis 188  
 Negative staining 12  
 Negri bodies 444, 532  
 Neil Moser reaction  
*Neisseria flavescens* 211  
*Neisseria gonorrhoeae* 201  
   identifying features of 206  
   virulence factors of (Table 26-2) 203  
*Neisseria lactamica* 211  
*Neisseria meningitidis* 207  
   identifying features of (Box 26-2) 208  
   virulence factors of (Table 26-4) 208  
*Neisseria meningitidis* 207  
*Neisseria sicca* 211  
*Neisseria* species 620

- Neisseria* species differential characteristics of (Table 26-3) 206
- Neisseria subflava* 211
- Neonatal conjunctivitis 421
- Nephelometry 106
- Nerve biopsy 368
- Neutral red test 353
- Neutralization 102
- Neutralization tests 110
- Newcastle disease viruses 505
- Niacin test 347, 353
- Nichol's strain 378
- Nichole's strain of *Treponema pallidum* 372
- Nine-banded armadillo 362
- Nipah virus 522
- Nitrate reduction test 354
- Nitroblue tetrazolium (NBT) test 146
- Nobel Prize winners (Table 1-2) 8
- Nocardia* 393
- Nocardia asteroides* 395
- Nocardia brasiliensis* 395
- Nocardia farcinica* 395
- Nocardia otitidiscaviarum* 395
- Nomenclature and definitions of hepatitis viruses (Table 66-1) 547
- Nomenclature of microorganisms 46
- Noncholera vibrio 302
- Nonclostridial anaerobic myonecrosis 267
- Nonculture *Candida* detection tests 610
- Nonencapsulated strains of *H. influenzae* 326
- Nonenveloped viruses 448
- Nonionizing radiations 29
- Nonparalytic poliomyelitis 499
- Nonpathogenic *Leptospira biflexa* 382
- Nonpathogenic treponemes 378
- Nonphotochromogens 359
- Nonpurpurative streptococcal diseases 188
- Nontreponemal tests 375
- Nontuberculous mycobacteria (NTM) 358
- Nontypable influenza strains 323
- Nonvenereal syphilis 374
- Nonvenereal treponematoses 377
- Normal Microbial Flora 619
- Northern blot 459
- Northern blot analysis 459
- Norwalk virus 585
- Nosocomial infection 73, 630
- Nosocomial *Morganella morganii* strains 268
- Nosocomial pneumonia 631
- Nucleic acid probes 57
- Nutrient broth 36
- O**
- O'nyong-nyong virus 538
- Oakley-Fulthorpe procedure 104
- Occupational syphilis 374
- Oerskovia* 398
- Oka strain 481
- Oklahoma tick fever 524
- Old tuberculin (OT) 349
- Omsk hemorrhagic fever 544
- Oncogenic DNA viruses 565
- Ophthalmia neonatorum 204
- Opportunistic fungal infections 608
- Opportunistic mycosis 595
- Oposonization 120
- Optochin sensitivity test 199
- Optochin-resistant pneumococci 194
- Orbivirus 524
- Orf 467
- Organ culture 456
- Organ-specific autoimmune diseases 158
- Orientia tsutsugamushi* 413
- Ornithodoros crossi* 380
- Ornithodoros lahorensis* 380
- Ornithodoros* species 380
- Ornithodoros tholozani* 380
- Oropharyngeal and esophageal candidiasis 609
- Oropharyngeal anthrax 226
- Oropharyngeal tularemia 336
- Orthomyxoviruses 505
- Orthopoxvirus 463
- Orthoreoviruses 525
- Ouchterlony procedure 104
- Outer membrane proteins (OMP) 15
- Owl's eye inclusion bodies 454
- Oxidase test 42, 208, 301
- Oxidation-fermentation test (OF test) 42
- Oxidizing agents 32
- Ozena 263
- P**
- P1 antigen 388
- Paracoccidiodomycosis 604
- Parainfluenza virus 517
- Paralytic poliomyelitis 499
- Paralytic rabies 532
- Parapoxviruses 463
- Parenteral transmission of HBV 553
- Parinaud's oculogenital conjunctivitis 421
- Paroxysmal nocturnal hemoglobinuria 146
- Parvovirus B19 493
- Parvoviruses 493
- Passive immunity 88
- Passive immunization 638
- Pasteurella multocida* 327
- Pasteurization 4, 25
- Pathogenesis and transmission of prion diseases 579
- Pathogenesis and transmission of prion-related slow diseases in human (Table 69-3) 580
- Pathogenesis of autoimmunity 156
- Pathogenesis of bacillary dysentery 283
- Pathogenesis of botulism 243
- Pathogenesis of brucellosis 339
- Pathogenesis of *Candida* infection 608
- Pathogenesis of *Chlamydia trachomatis* infection 420
- Pathogenesis of cholera 298
- Pathogenesis of CMV infection 485
- Pathogenesis of cryptococcal infection 606
- Pathogenesis of diphtheria 215
- Pathogenesis of fungal infection 594
- Pathogenesis of gonorrhea 203
- Pathogenesis of *Haemophilus influenzae* infection 323
- Pathogenesis of HAV infection 548
- Pathogenesis of HBV infection 551
- Pathogenesis of HCV infections 555
- Pathogenesis of *Helicobacter pylori* infection 309
- Pathogenesis of HIV infection 568
- Pathogenesis of HPIV infection 518
- Pathogenesis of HPV infections 471
- Pathogenesis of HSV infection 478
- Pathogenesis of HTLV infection 564
- Pathogenesis of influenza 508
- Pathogenesis of Legionnaire's disease 403
- Pathogenesis of leprosy 364
- Pathogenesis of leptospirosis 383
- Pathogenesis of meningitis 208
- Pathogenesis of mumps 519
- Pathogenesis of parvovirus infections 494
- Pathogenesis of pertussis 332
- Pathogenesis of plague 288
- Pathogenesis of pneumococcal diseases 197
- Pathogenesis of poliomyelitis 498
- Pathogenesis of rabies 530
- Pathogenesis of relapsing fever 379
- Pathogenesis of rickettsial infections 408
- Pathogenesis of rotavirus diarrhea 526
- Pathogenesis of rubella 583
- Pathogenesis of small pox 464
- Pathogenesis of staphylococcal infections 177
- Pathogenesis of streptococcal infections 188
- Pathogenesis of syphilis 373
- Pathogenesis of tetanus 239
- Pathogenesis of tuberculosis 348
- Pathogenesis of viral infections 440
- Pathogenesis of VZV infections 479
- Pathogenic *Leptospira interrogans* 382
- Pathogenic microorganisms in milk 626
- Patoc I strain 385
- Paul-Bunnell test 483
- Pawlowsky medium 346
- PCR technique 58
- Pediatric AIDS 571
- Pediculus humanus capitis* 408
- Pediculus humanus corporis* 380, 408
- Pelvic inflammatory disease (PID) 204
- Penicillin resistance in staphylococci 181
- Penicillinase producing strains of *Staphylococcus* 70
- Penicillin-resistant strains 200
- Penicilliosis 614
- Penicillium marneffeii* 614
- Pentameric IgM 98
- Peptic ulcer disease 310
- Peptostreptococcus* 247
- Peptostreptococcus anaerobius* 247
- Peptostreptococcus magnus* 247
- Perinatal CMV infection 486
- Perinatal infection in HIV 573
- Perinatal transmission of HBV 556
- Perinatally acquired HIV infection 571
- Peripheral lymphoid organs 123
- Persistent measles infection 582
- Persistent viral infection 444
- Pertussis toxin 331
- Petroff's method 352
- Peyer's patches 124
- Phaeohyphomycosis 601
- Phage typing 45
- Phage typing of human isolates of *Staphylococcus aureus* (Table 23-5) 179
- Phage typing of *Salmonella* Typhi 462
- Phage typing of streptococci 189
- Phage typing of *Vibrio cholerae* 296
- Phagocyte deficiencies 146
- Pharyngitis 187
- Pharyngoconjunctival fever 490
- Phase-contrast microscopy 10
- Phenotypic techniques 45

- Phenyl pyruvic acid (PPA reaction) 265  
*Phialophora verrucosa* 601  
 Phosphatase test 627  
 Photochromogens 358  
 Phylogenetic classification 45  
 Picornavirus 496  
*Piedraia hortae* 597  
 Pili 19, 314, 323,  
 Pinta 378  
*Pityriasis versicolor* 597  
*Pityrosporum orbiculare* 597  
 Plague toxins 287  
 Plague vaccine 291  
 Planococcus 182  
 Plaque assay 458  
 Plasma cells 130  
 Plasma torch 636  
 Plasmids 49  
   functions of 50  
   nontransmissible 49  
   transmissible 49  
 Plasmid-mediated antibiotic resistance  
 (Table 9-3) 66  
 Plasmid-mediated resistance 66  
*Plesiomonas* 304  
*Plesiomonas shigelloides* 304  
 Pleural effusion 350  
 Pneumococcal antibody detection 199  
 Pneumococcal antigen detection 199  
 Pneumococcal meningitis 197  
 Pneumococcal pneumonia 197  
 Pneumococcal vaccines 199  
*Pneumocystis carinii* 612  
*Pneumocystis jiroveci* 612  
 Pneumocystosis 612  
 Pneumolysin 196  
 Pneumonic plague 288  
 Pneumovirus 514  
 Pock assay 458  
 Pocks on chorioallantoic membrane 464  
 Poliovirus 496  
 Polyhedral viruses 430  
 Polymerase chain reaction 57  
 Polyomavirus 471  
 Ponder stain 217  
 Pontiac fever 402  
 Pooled human immunoglobulin 639  
*Porphyromonas asaccharolytica* 248  
*Porphyromonas gingivalis* 248  
*Porphyromonas* spp. 249  
 Poststreptococcal glomerulonephritis 158  
 Post-zone phenomenon 103  
 Potable water 623  
 Pour-plate culture 38  
 Poxviruses 463  
 PPLO broth 387  
 Prausnitz-Kustner reaction 152  
 Precipitation 102  
 Precipitation reactions 103  
 Precipitation in agar 104  
 Presumptive coliform count 625  
 Prevalence of antigenic subtypes of influenza  
 virus type A (Table 61-5) 510  
 Prevention of tetanus  
   primary 242  
   secondary 242  
 Prevention of viral diseases 448  
*Prevotella bivia* 248  
*Prevotella disiens* 248  
*Prevotella intermedia* 248  
*Prevotella melaninogenica* 248  
*Prevotella* spp. 249  
 Primary atypical pneumonia 388  
 Primary cutaneous nocardiosis 396  
 Primary disc diffusion test 70  
 Primary immunodeficiencies 143  
 Primary infection 73  
 Primary lymphoid organs 122  
 Primary nonbacteremic pseudomonas  
 pneumonia 316  
 Primary response 134  
 Primary syphilis 373  
 Primary tuberculosis 348  
 Prion disease 579  
 Prions 438, 578  
 Progressive disseminated histoplasmosis 605  
 Progressive multifocal leukoencephalopathy  
 (PML) 852  
 Properties of enveloped virus (Table 50-2) 431  
 Properties of human DNA viruses  
 (Table 50-6) 438  
 Properties of human RNA viruses  
 (Table 50-7) 439  
 Properties of retroviruses (Table 67-4) 565  
*Propionibacterium acnes* 247  
*Propionibacterium propionicum* 393  
*Propionibacterium propionicus* 247  
*Propionibacterium* spp. 247  
 Prosthetic valve endocarditis 403  
 Protective antigen 224  
 Proteins of *Mycobacterium tuberculosis* 346  
*Proteus* 265  
*Proteus mirabilis* 265  
*Proteus myxofaciens* 265  
*Proteus penneri* 265  
*Proteus vulgaris* 265  
 Proticin typing 267  
*Providencia* 265  
*Providencia alcalifaciens* 268  
*Providencia heimbachae* 268  
*Providencia rettgeri* 268  
*Providencia rustigianii* 268  
*Providencia stuartii* 268  
 Prozone phenomenon 103, 343, 375  
 PRP-protein conjugate vaccines 323  
*Pseudoallescheria boydii* infection 615  
 Pseudoanthrax bacilli 229  
 Pseudohyphae 594  
 Pseudomonal cellulites 316  
 Pseudomonal endophthalmitis 316  
 Pseudomonal folliculitis 316  
 Pseudomonal infectious endocarditis 316  
 Pseudomonal meningitis 316  
*Pseudomonas aeruginosa* 313  
*Pseudomonas fluorescens* 313  
*Pseudomonas mallei* 318  
*Pseudomonas maltophilia* 318  
*Pseudomonas putida* 313  
 Pseudomonas skin infections 316  
*Pseudomonas stutzeri* 313  
 Pseudomonas vaccines 318  
 Pseudovirions 435  
 Psittacosis lymphogranuloma trachoma (PLT)  
 viruses 418  
 Pulmonary cryptococcosis 606  
 Pulmonary tuberculosis 349  
 Pulmonary zygomycosis 612  
 Purified protein derivative (PPD) 346  
 Purulent gonococcal conjunctivitis 204  
 Pyoderma 187  
 Pyrazinamide test 354
- 
- Q**
- Quantal assays of infectivity 458  
 Quellung's reaction 18, 262
- 
- R**
- R factor 50  
 R proteins 185  
 Rabbit fever 335  
 Rabbit ileal loop method 260  
 Rabbit ileal loop test 298  
 Rabbit pyrogenicity test 81  
 Rabies 531  
 Rabies virus 529  
 Rabies-like fatal disease in humans 535  
 Rabies-related viruses 535  
 Racial immunity 85  
 Radial immunodiffusion 104  
 Radiation for sterilization types and uses of  
 (Table 3-2) 28  
 Radioimmunoassay 113  
 Ramsay Hunt syndrome 480  
 Rapid plasma reagin (RPR) 376  
 Rapid urea breath test 311  
 Rapidly growing *Mycobacterium* species 358  
 Rat flea 411  
 Rat leprosy 370  
 Rat-bite fever 401  
 Reagin antibody 99  
 Real-time PCR 59  
 Recombinant DNA HBV vaccines 554  
 Recombinant DNA technology 59  
 Recrudescence typhus 409  
 Recurrent meningococcal meningitis 209  
 Regulation of alternative pathway 120  
 Regulation of immune responses 126  
 Regulatory functions of T cells 128  
 Reinfection 73  
 Reiter syndrome 284  
 Reiter's protein 372  
 Reiter's strain of *Treponema pallidum* 372  
 Reiter's syndrome 422  
 Reiter's treponeme 376  
 Relapse in brucellosis 344  
 Relapsing fever 379  
 Relapsing louse-borne typhus 408  
 Replication of viruses 433  
 Reproduction of fungi 593  
 Resistance transfer factor (RTF) 50  
 Resolving power of  
   electron microscope 11  
   microscope 9  
 Respiratory diphtheria 216  
 Respiratory syncytial virus 521  
 Respiratory tract candidiasis 609  
 Respirovirus 517  
 Restriction endonucleases 56  
 Restriction enzymes 55  
 Restriction fragment length polymorphisms  
 (RFLPs) 56  
 Reticulate body (RB) 418

- Retroviruses 562  
 Retrovirus genes and their functions (Table 67-2) 561  
 Reverse passive hemagglutination (RPHA) 108  
 Reynold-Braude phenomenon 610  
 Rh blood group antigens 168  
 Rh blood group system 168  
 Rh systems 167  
 Rhabdoviruses 529  
 Rheumatic fever 188  
 Rheumatoid arthritis 154  
 Rhinocerebral zygomycosis 612  
 Rhinoscleroma 263  
 Rhinosporidiosis 602  
*Rhinosporidium seeberi* 602  
 Rhinoviruses 503  
*Rhizopus arrhizus* 612  
*Rhodococcus* 397  
*Rhodococcus equi* 397  
*Rickettsia akari* 413  
*Rickettsia australis* 413  
*Rickettsia conori* 414  
*Rickettsia prowazekii* 408  
*Rickettsia quintana* 405  
*Rickettsia rickettsiae* 411  
*Rickettsia siberica* 413  
*Rickettsia* species 414  
*Rickettsia typhi* 410  
 Rickettsial pox 413  
 Rideal and Walker test 33  
 Rift Valley fever viruses 545  
 Ring test 104  
 Risk factors for tuberculosis 350  
 Robert Koch 5  
*Rochalimaea quintana* 405  
 Rocket electrophoresis 105  
 Rocky Mountain spotted fever 411  
 Role of immunoglobulins in human defense (Table 13-3) 100  
 Rose Bengal card test 343  
   human infections caused by most common  
     *Mycobacterium* species (Table 41-1) 345  
     *Mycobacteria other than typical tubercle (MOTT)* 345  
     *Mycobacterium microti* 345  
 Rotavirus 526  
 Rous sarcoma virus 562  
 Routes of entry of microbial pathogens (Table 10-5) 77  
 RSV-like diseases 523  
 Rubella 584  
 Rubella virus 538  
 Rubeola infantum 488  
 Rubulavirus 517  
 Russian spring-summer encephalitis 544
- S**
- Sabin vaccine 500  
*Saccharomyces* species 610  
 Salient features of various biotypes of  
   *Corynebacterium diphtheriae* (Table 27-2) 214  
 Salk vaccine 500  
*Salmonella* 269  
 Salmonella bacteremia 280  
 Salmonella Choleraesuis 280  
 Salmonella gastroenteritis 280  
 Salmonella Paratyphi 261, 269  
 Sandwich ELISA 112  
 SARS virus 588  
 Satellitism 322  
 Saukett strains 498  
 Scanning electron microscopy 11  
 Scarlet fever 188  
 Schick test 110  
 Schultz Charlton test 186  
 Scotochromogens 359  
 Scrapie 581  
 Scrapie prion protein 579  
 Scrapie-like disease of mink 581  
 Screening of blood for HIV antibodies 577  
 Scrub typhus 414  
 Secondary immunodeficiencies 147  
 Secondary lymphoid organs 123  
 Secondary response 134  
 Secondary syphilis 373  
 Second-line antitubercular drugs 356  
 Secretory IgA 98  
 Selective IgA deficiency 144  
 Selective immunoglobulin deficiencies 143  
 Selective media used in routine microbiology laboratories (Table 4-3) 37  
 Selective theory 136  
 Sella's technique 532  
 Semiquantitative culture of urine 259  
 Semisynthetic antibiotics 61  
 Sennetsu fever 415  
 Sensitivity of serological tests for syphilis (Table 44-4) 377  
 Septicemic plague 288, 289  
 Sequential epitopes 91  
 Sequestered antigens 92, 157  
 Sereny test 260  
 Serodiagnosis of  
   acute Q fever 417  
   chronic Q fever 417  
   coccidioidomycosis 603  
   dengue fever 542  
   enteric fever 274  
   fungal infections 596  
   HAV infection 548  
   leprosy 365  
   SARS 589  
 Serologic profile for EBV infections (Table 57-5) 484  
 Serotypes of *Vibrio cholerae* O1 (Table 35-2) 296  
 Serotyping of pneumococci 196  
*Serratia marcescens* 264  
*Serratia sepsis* 264  
 Serum IgA 98  
 Serum markers in hepatitis B infection 554  
 Serum opacity factor 186  
 Serum sickness 153  
 Settle plate method 628  
 Severe acute respiratory syndrome (SARS)-associated coronavirus 583, 588  
 Sewage bacteria 623  
 Sexual and perinatal transmission of HDV 558  
 Sexual transmission of HBV 553  
 Shell vial assay 487  
 Shiga toxin 255, 283  
*Shigella boydii* 281  
*Shigella dysenteriae* serotype 1 281  
*Shigella flexneri* 281  
*Shigella* septicensia 284  
*Shigella sonnei* 304  
 Shigellosis 284  
 Shotgunning 57  
 Sickle cell disease 389  
 Side chain theory 136  
 Significant bacteriuria 259  
 Silver impregnation method 371  
 Silver impregnation staining methods 384  
 Simple stains 12  
 Single-strength McConkey broth 625  
 Sintered glass filters 28  
 Skeletal tuberculosis 350  
 Skin biopsy 368  
 Skin test using coccidioidal antigens 603  
 Skirrow's medium 307  
 Slender loris 363  
 Slide agglutination 107  
 Slit and scrap method 367  
 Slit sampler method 628  
 Slit-skin smears 367  
 Slow disease caused by a conventional virus in animals 582  
 Slow disease caused by a conventional virus in humans 582  
 Slow diseases caused by prions 578  
   in humans 580  
 Slow infectious diseases 578  
 Slow viruses and prions 578  
 Slow-growing *Mycobacterium* species 358  
 Slow-reacting substances of anaphylaxis 150  
 Smallpox vaccine 466  
 Smith-Noguchi medium 372  
 Soft chancre 321  
 Soft ticks 380  
 Soil bacteria 623  
 South American blastomycosis 604  
 South American hemorrhagic fever 587  
 Southern blot analysis 459  
 Spatula test 241  
 Special media 36  
 Specialized transduction 52  
 Species immunity 85  
 Species-specific antigens of *T. pallidum* 372  
 Species-specific treponemal antigen 372  
 Specific hyperimmune immunoglobulin 639  
 Specific tests for laboratory diagnosis of HIV infection and AIDS (Table 68-5) 574  
*Spirillum minus* 401  
 Spleen  
   functions of 124  
 Spores 20  
 Sporotrichosis 601  
 Squamous cell esopharyngeal cancer 310  
 Stab culture 38  
 Standard tube agglutination tests 343  
 Staphylococcal food poisoning 177  
 Staphylococcal phage typing 179  
 Staphylococcal scalded skin syndrome 178  
 Staphylococcal toxic shock syndrome 178  
*Staphylococcus aureus* 173  
*Staphylococcus epidermidis* 181  
*Staphylococcus baemolyticus* 173  
*Staphylococcus hominis* 173  
*Staphylococcus lugdunensis* 173  
*Staphylococcus saccharolyticus* 173  
*Staphylococcus saprophyticus* 173  
*Staphylococcus schleiferi* 173  
*Staphylococcus warneri* 173  
*Stenotrophomonas maltophilia* 313

- Sterilants 24  
 Sterilization 24  
   chemical methods of sterilization 29  
   by dry heat 27  
   by moist heat 25  
   physical methods of 24  
   by steam under pressure 25  
   at a temperature above 100°C 25  
   at a temperature below 100°C 25  
   at a temperature of 100°C 25  
 Sterilization controls 26  
 Sterne vaccine 229  
 Stevens-Johnson syndrome 388  
 Stokes method 69  
*Stomatococcus* 182  
 Stool cytotoxin test 246  
 Strategies for HIV testing in India 575  
 Strauss reaction 318  
 Streak culture 38  
 Street virus 530  
*Streptobacillus moniliformis* 401  
 Streptococcal erysipelas 400  
 Streptococcal grouping 104  
 Streptococcal pyrogenic exotoxins (Spes) 186  
 Streptococcal toxic shock syndrome 188  
*Streptococcus* 183  
*Streptococcus agalactiae* 191  
*Streptococcus bovis* 192  
*Streptococcus equinus* 192  
*Streptococcus equisimilis* 191  
*Streptococcus* MG 192  
*Streptococcus* MG agglutination test 390  
*Streptococcus mitis* 192  
*Streptococcus mutans* 192  
*Streptococcus pneumoniae* 194  
*Streptococcus pyogenes* 78, 184  
   identifying features of (Box 24-1) 190  
   virulence factors of (Table 24-2) 186  
*Streptococcus salivarius* 183  
*Streptococcus sanguis* 192  
 Streptokinase 186  
 Streptolysin O 187  
 Streptolysin S 187  
*Streptomyces somaliensis* 601  
 String of pearls reaction 223  
 Stroke culture 38  
 Structure of DNA 47  
 Structure of RNA 47  
 Subacute endocarditis 416  
 Subacute progressive encephalopathy 580  
   vCJD 580  
 Subacute sclerosing panencephalitis 582  
 Subcutaneous mycosis 600  
 Subunit vaccines 638  
 Sugar media 37  
 Superantigens 80, 93  
 Superficial mycosis 597  
 Suppurative streptococcal diseases 187  
 Surface active agents 32  
   anionic 32  
   amphoteric 32  
   cationic 32  
   non-ionic 32  
 Swarming 265  
 Sylvatic plague 290  
 Synthetic antimicrobial drugs 61  
 Synthetic medium 36  
 Syphilis in persons with HIV 374  
 Syphilis transmission 374  
 Systemic autoimmune diseases 159, 160  
 Systemic lupus erythematosus (SLE) 160
- T**
- TAB vaccine 279  
 Tabes dorsalis 374  
 Tanapox 468  
 T-cell epitopes 91  
 T-cell immunodeficiencies 144  
 T-cell receptor 127  
 T-cell tolerance 156  
 T-cell-independent antigens 135  
 Teichoic acids 14  
 Teichuronic acid 14  
 Temperate cycle 461  
 Temperature-sensitive mutants 436  
 Tertiary syphilis 374  
 Tests for detection of CMI 141  
 Tetanolysin 238  
 Tetanospasmin 238  
 Tetanus immunoglobulin (TIG) 241  
 Tetanus toxoid 242  
 Tetrazolium reduction test 390  
 T-even phages 460  
 The categories of biomedical waste as defined by the pollution control board (Table 78-1) 635  
 Theories of antibody formation 135  
 Theory of clonal deletion 156  
 Theory of spontaneous generation 4  
 Thiosulfate bile salt sucrose (TCBS) medium 295  
 Thoracic actinomycosis 394  
 Thymectomized mouse 362  
 Thymic aplasia 144  
 Thymus 122  
   functions of 123  
 Tick-borne encephalitis viruses 544  
 Tick-borne hemorrhagic fever 544  
 Tick-borne relapsing fever 379  
 Tick fever 335  
 Ticks 412  
*Tinea barbae* affecting beard areas of face and neck 599  
*Tinea capitis* involving scalp 599  
*Tinea corporis* involving nonhairy skin 599  
*Tinea cruris* affecting groin 599  
*Tinea nigra* 597  
*Tinea pedis* affecting foot 599  
 Togaviruses 536  
 Togaviruses, flaviviruses, bunyaviruses, reoviruses, and rhabdoviruses associated with human infections (Table 65-1) 536  
 Total count 21  
 Total virus particles count 458  
 Toxic shock syndrome toxin 176  
 Toxin neutralization tests 110  
 Toxin-mediated staphylococcal diseases 177  
*Toxoplasma* encephalitis 571  
 TPHA test 377  
 TPIT 376  
 Tracheal cytotoxin 332  
 Trachoma 421  
 Trachoma and inclusion conjunctivitis (TRIC) 420  
 Transduction 51  
   complete 52  
   generalized 52  
 Transfection 60, 461  
 Transfer factor 142, 369  
 Transfer of DNA within bacterial cells 50  
 Transformation 51, 443  
 Transfusion of *Treponema pallidum*—contaminated blood 374  
 Transfusion reaction 152, 169  
 Transfusion-acquired CMV infection 486  
 Transient hypogammaglobulinemia of infancy 144  
 Transmissible spongiform encephalopathies 578  
 Transmission and habitat of some important fungi in India (Table 71-3) 595  
 Transmission of CMV 486  
 Transmission of HIV infection 572  
 Transport media 37  
 Transposition 50  
 Transposons 50  
 Transposons-mediated resistance 66  
 Traveler's diarrhea 258  
 Treatment of HEV infection 559  
 Treatment of leprosy 369  
*Treponema denticola* 378  
*Treponema macrodentium* 378  
*Treponema oralis* 378  
*Treponema pallidum* 371  
*Treponema pallidum* agglutination test 376  
*Treponema pallidum* group-specific antigen 372  
*Treponema pallidum* immobilization test 376  
*Treponema pallidum* immune adherence test 376  
*Treponema pallidum* species-specific antigen 372  
*Treponema pectinovorum* 378  
*Treponema pertenuae* 371, 378  
*Treponema phagedenis* 372  
*Treponema refringens* 372  
*Treponema socranski* 378  
 Treponemal antigens 373  
 Treponema-specific tests 376  
*Trichophyton ajelloi* 599  
*Trichophyton* infection 599  
*Trichophyton rubrum* 598  
*Trichophyton schoenleinii* 599  
*Trichophyton tonsurans* 599  
*Trichophyton violaceum* 598  
 Triple DTaP vaccine 219  
 Triple vaccine 242  
*Tropheryma whippelii* 398  
 Tube agglutination test 107  
 Tubercle 349  
 Tubercular lymphadenitis 350  
 Tubercular meningitis 349  
 Tuberculin hypersensitivity reaction 349  
 Tuberculin sensitivity 364  
 Tuberculin skin test 155, 355  
 Tuberculin test 349  
 Tuberculosis of the middle ear 350  
 Tuberculosis of the skin 350  
 Tuberculosis with HIV 350  
 Tularemia 335  
 Tularemia tube agglutination test 336  
 Tumor necrosis factor (TNF- $\alpha$ ) 141  
 Tunica reaction 411  
 Tunica vaginalis reaction 411  
 Turbidity 106  
 Turbidity test 627  
 Tween 80 hydrolysis test 354  
 Ty21a oral vaccine 280  
 Tyndallization 27

Type I (Anaphylactic) hypersensitivity 149  
 Type I immediate hypersensitivity (atopy) 99  
 Type II (Cytotoxic) hypersensitivity 152  
 Type III (immune-complex) hypersensitivity 153  
 Type IV delayed (cell-mediated) hypersensitivity 154  
 Type V (stimulatory type) hypersensitivity 155  
 Types and subtypes of influenza virus (Table 61-4) 508  
 Types of biomedical waste 634  
 Types of DTH reactions 154  
 Types of mutations 48  
 Types of vaccines available against influenza virus (Table 61-7) 513  
 Typhoid Mary 275  
 Typhoid vaccine 640  
 Typhoidal (septicemic) tularemia 336  
 Typing of bacterial strains 44  
 Typing of *Corynebacterium diphtheria* 217  
 Typing of *Shigella* 284  
 Tzanck smear 478

**U**

Ulceroglandular tularemia 336  
 Ultraviolet (UV) radiation 29  
 Unclassified immunodeficiency 144  
 Universal donor 169  
 Universal immunization programme 638  
 Universal immunization schedule in India (Table 79-1) 638  
 Universal recipient 169  
 Urban or domestic plague 289  
*Ureaplasma urealyticum* 143, 391  
 Urease test 43, 311, 600  
 Urinary tract infections 266  
 Urogenital infections 421  
 Uses of bacteriophages 462  
 UV radiations 29

**V**

V factor 322  
 Vaccination against tuberculosis 356  
 Vaccine preventable diseases 637  
 Vaccine-associated poliomyelitis 500  
 Vaccinia virus 466  
 van der Waals bonds 101  
 Variant CJD 580  
 Varicella vaccine 481  
 Varicella zoster immunoglobulin (VZIG) 481  
 Varicella zoster virus 479  
 Variola major 465  
 Variola minor 465  
 Variolation 466  
 VDRL enzyme-linked immunosorbent assay (ELISA) 376  
 VDRL test 375  
 Vectors 55  
*Veillonella parvula* 247  
 Venereal syphilis 374, 373  
 Venezuelan equine encephalitis virus 536  
 Venkatraman-Ramakrishnan (VR) medium 295  
 Vertical HIV infection 572  
 Vertical transmission of microbial agents (Table 10-4) 76

Vesicular stomatitis virus 529  
 Vi antigen 271  
 Viable count 21  
*Vibrio alginolyticus* 303  
*Vibrio cholerae* 294  
*Vibrio damsela* 303  
*Vibrio fluvialis* 303  
*Vibrio furnissii* 303  
*Vibrio hollisae* 303  
*Vibrio metschnikovii* 303  
*Vibrio mimicus* 302  
*Vibrio parahaemolyticus* 302  
 Vibrio phage typing 301  
*Vibrio vulnificus* 303  
 Vincent's angina 381  
 Vincent's spirochetes 217  
 Viral assays 457  
 Viral attachment protein (VAP) 431  
 Viral genetics 435  
 Viral hemagglutination 108  
 Viral hemagglutination inhibition test 110  
 Viral hemorrhagic fever 586  
 Viral nucleic acid 432  
 Viral oncogenes of DNA and RNA viruses (Table 67-3) 562  
 Viral proteins and lipids 432  
 Viral serology 459  
 Virchow's lepra cells 362  
 Viridans streptococci 192  
 Virulence factors of anaerobic Gram-negative bacilli (Table 30-2) 248  
 Virulence factors of *Bacillus anthracis* (Table 28-2) 224  
 Virulence factors of *Bordetella pertussis* (Table 39-2) 331  
 Virulence factors of *Brucella* species (Table 40-4) 340  
 Virulence factors of *Clostridium perfringens* (Table 29-2) 234  
 Virulence factors of *Haemophilus influenzae* (Table 38-2) 323  
 Virulence factors of *Mycobacterium leprae* (Table 43-1) 363  
 Virulence factors of *Pseudomonas aeruginosa* (Table 37-2) 315  
 Virulence factors of *Salmonella* spp. (Table 32-3) 273  
 Virulence factors of *Shigella* species (Table 33-5) 283  
 Virulence factors of *Streptococcus pneumoniae* (Table 25-1) 196  
 Virulence factors of *Treponema pallidum* (Table 44-2) 373  
 Virulence factors of *Vibrio cholerae* (Table 35-3) 297  
 Virulence of *Yersinia enterocolitica* 292  
 Virulent factors of *Corynebacterium diphtheria* (Table 27-3) 215  
 Virulent factors of *Helicobacter* species (Table 36-4) 309  
 Virulent factors of *Staphylococcus aureus* (Table 23-3) 175  
 Virulent factors of *Yersinia pestis* (Table 34-2) 287  
 Virus neutralization tests 110  
 Visna 582  
 Visna virus of sheep 560

Voges-Proskauer test 44  
 Volutin granules 214  
 von Magnus phenomenon 435  
 VZV infection in immunocompromised patients 480

**W**

Waldenstrom's macroglobulinemia 100  
*Wangiella dermatitidis* 601  
 Warthin Starry impregnation stain 406  
 Wasserman complement fixation test 375  
 Wassermann test 110  
 Waste treatment and disposal 634  
 Water-borne microorganisms (Table 76-2) 624  
 Waterhouse Fredrickson's syndrome 209  
 Weapon-grade anthrax spores 227  
 Weil's syndrome 383  
 Weil-Felix test 107  
 Weil-Felix test in rickettsial diseases 410  
 Welch method 18  
 West Nile virus 539  
 West's postnasal swab 333  
 Western blotting 114  
 Western equine encephalitis virus 538  
 Wet Indian ink method 18  
 Whipple's disease 398  
 White piedra 598  
 White tick deer 415  
 Whitmore's bacillus 318  
 WHO immunization program 638  
 Whole cell inactivated vaccine 334  
 Whooping cough 332  
 Widal test 107, 278  
 Window period 573  
 Wiskott-Aldrich syndrome 145  
 Wool sorters' disease 226  
 Working pneumonia  
 Wound botulism 244

**X**

X and V growth factors 406  
 X factor 322  
 Xenodiagnosis 405  
*Xenopsylla cheopis* 411  
 X-linked agammaglobulinemia 143  
 X-linked hypogammaglobulinemia 143  
 X-linked SCID 145

**Y**

Yabapox 468  
 Yaws 378  
 Yellow fever virus 541  
 Yellow rice toxicosis 595  
*Yersinia enterocolitica* 291  
*Yersinia pestis* 286  
*Yersinia pseudotuberculosis* 292

**Z**

Ziehl-Neelsen staining method 395  
 Zygomycosis 612

# Color Photos

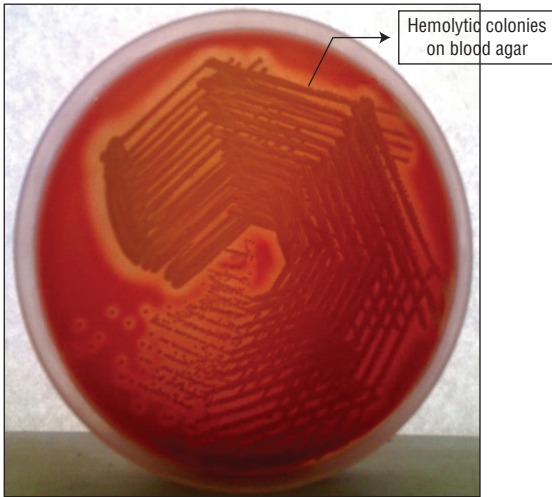

**COLOR PHOTO 1.** Blood agar showing hemolytic colonies of group A streptococci.



**COLOR PHOTO 2.** MacConkey agar showing lactose fermenting red colonies of *Escherichia coli*.



**COLOR PHOTO 3.** McIntosh-Fildes anaerobic jar.

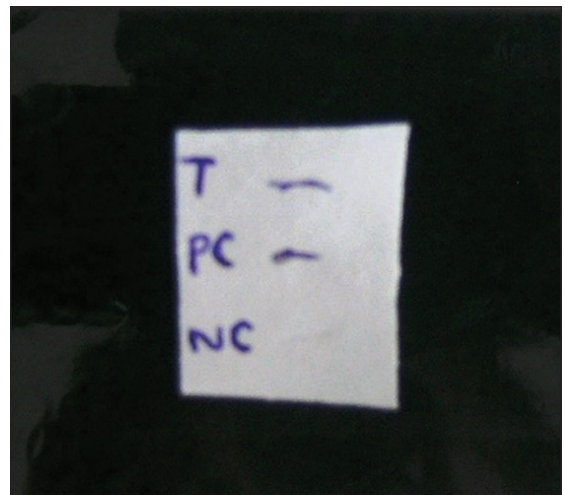

**COLOR PHOTO 4.** Oxidase test. T, test; PC, positive control; NC, negative test.

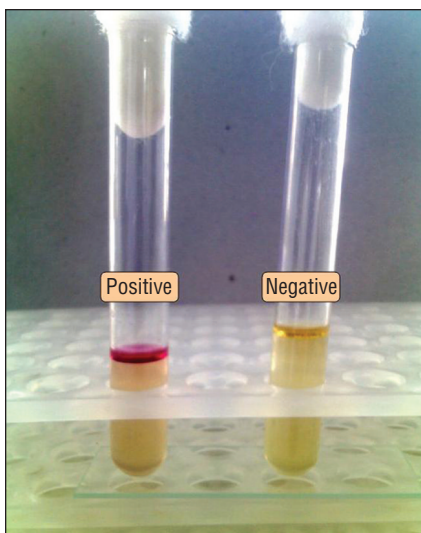

**COLOR PHOTO 5.** Indole test.

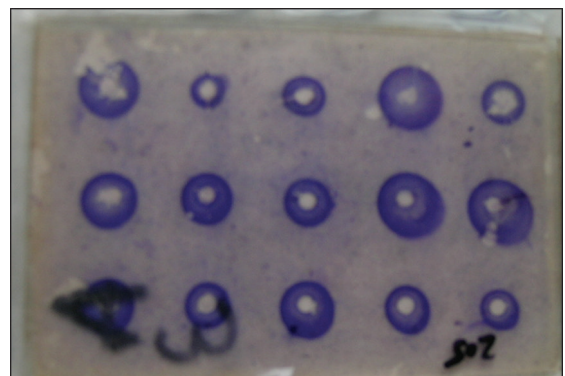

**COLOR PHOTO 6.** Radial immunodiffusion.

**CP2** COLOR PHOTOS

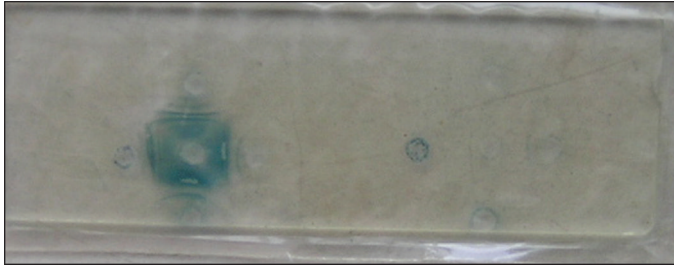

**COLOR PHOTO 7.** Double diffusion in two dimensions.

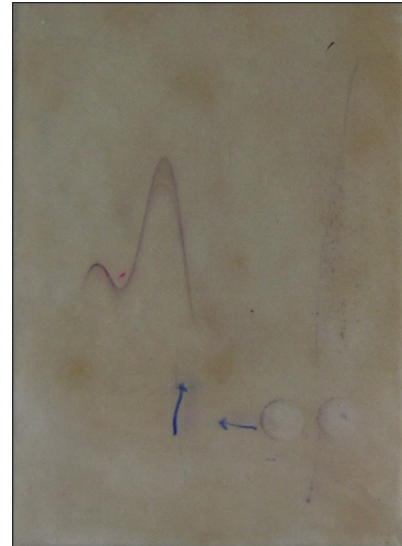

**COLOR PHOTO 8.** Photograph of rocket electrophoresis.

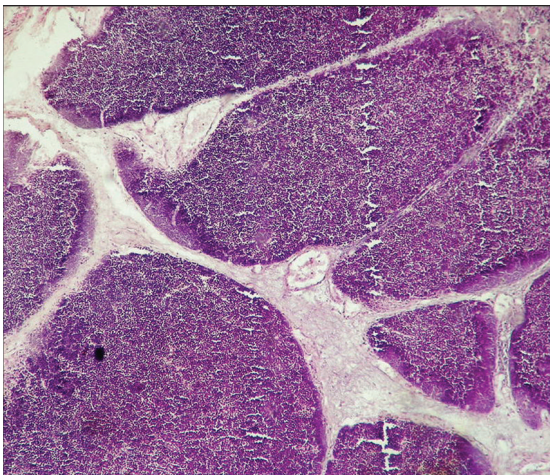

**COLOR PHOTO 9.** Histological section of the thymus (x1000).

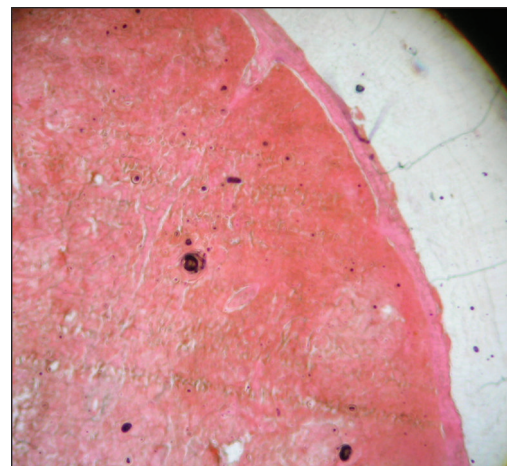

**COLOR PHOTO 10.** Histological section of the lymph node (x1000).

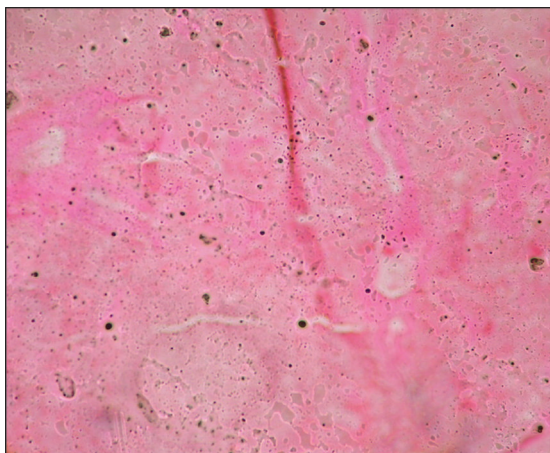

**COLOR PHOTO 11.** Histological section of the spleen (x1000).

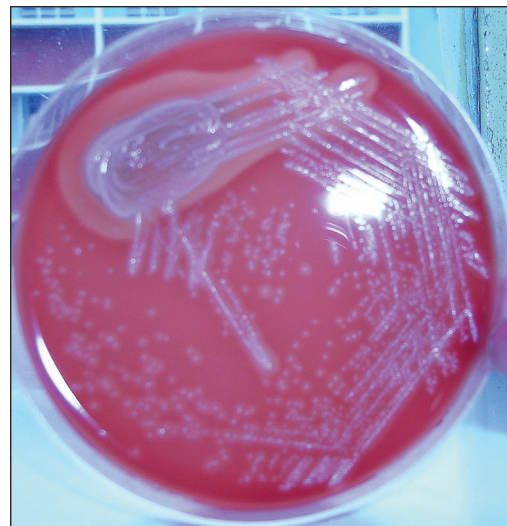

**COLOR PHOTO 12.** Blood agar plate showing beta hemolysis surrounding the colonies of *Staphylococcus aureus*.



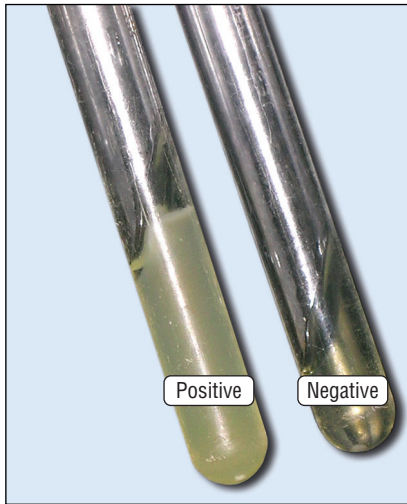

**COLOR PHOTO 13.** Coagulase test.

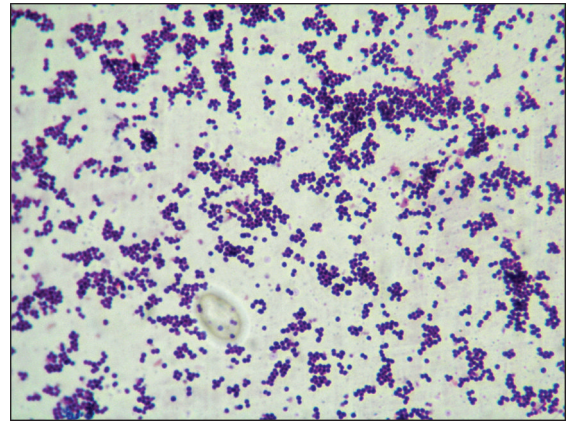

**COLOR PHOTO 14.** Gram-stained pus smear showing staphylococci ( $\times 1000$ ).

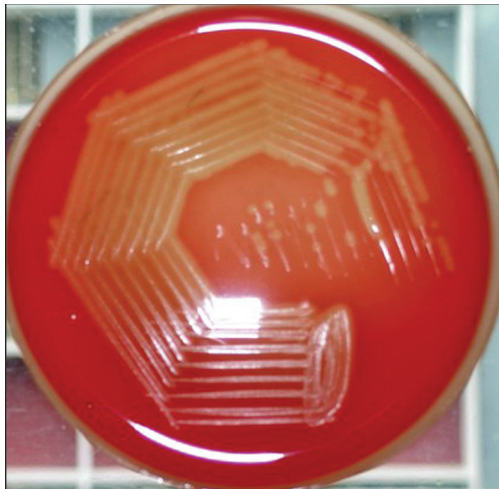

**COLOR PHOTO 15.** Blood agar plate showing beta hemolysis surrounding the colonies of *Streptococcus pyogenes*.

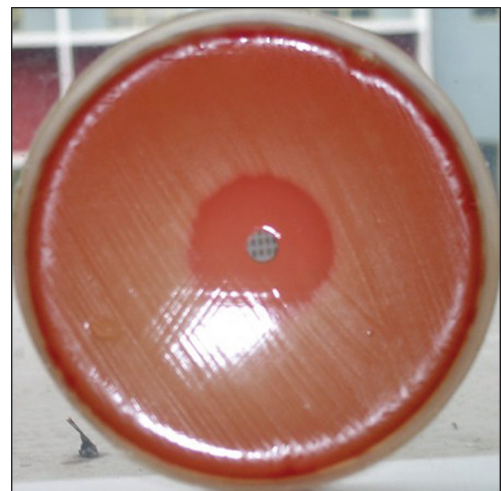

**COLOR PHOTO 16.** Bacitracin sensitivity of *Streptococcus pyogenes*.

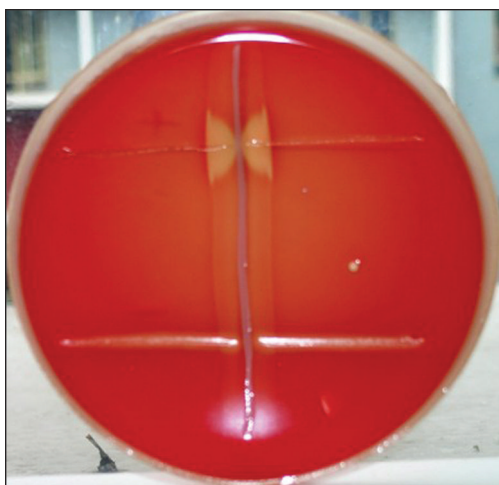

**COLOR PHOTO 17.** CAMP test for *Streptococcus agalactiae*.

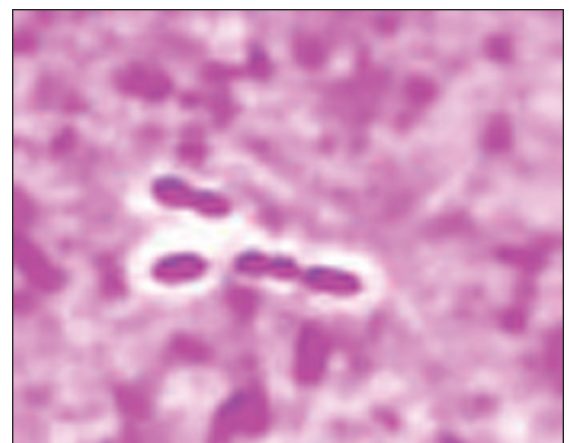

**COLOR PHOTO 18.** Lanceolate-shaped pneumococci ( $\times 1000$ ).

**CP4** COLOR PHOTOS

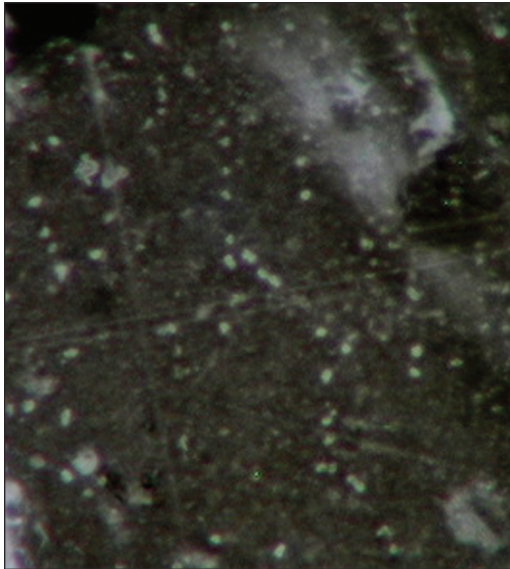

**COLOR PHOTO 19.** Demonstration of the capsule of pneumococci by Indian ink staining ( $\times 400$ ).

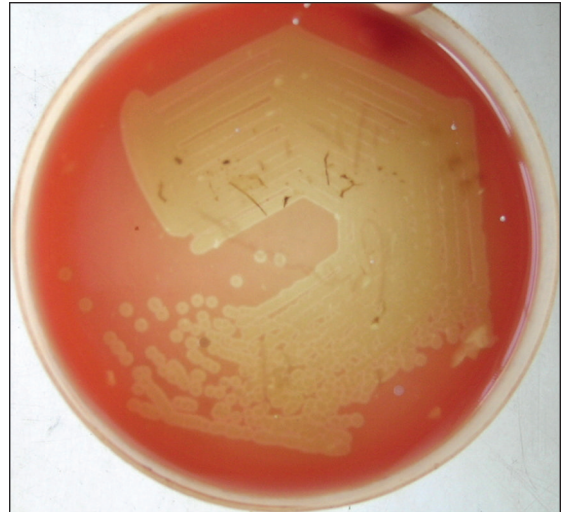

**COLOR PHOTO 20.** Blood agar showing alpha hemolysis on blood agar produced by *Streptococcus pneumoniae*.

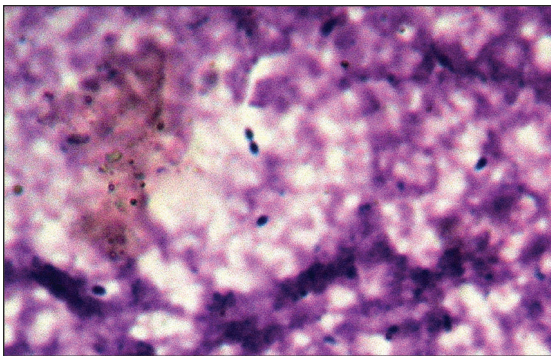

**COLOR PHOTO 21.** Gram-stained smear of CSF showing *Streptococcus pneumoniae* in pairs ( $\times 1000$ ).

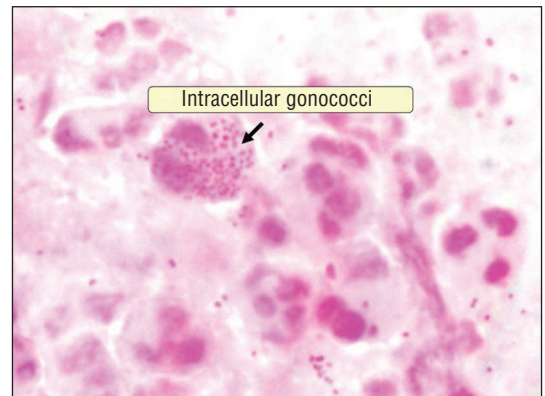

**COLOR PHOTO 22.** Gram-negative intracellular *Neisseria gonorrhoeae* in Gram-stained smear of pus exudate ( $\times 1000$ ).

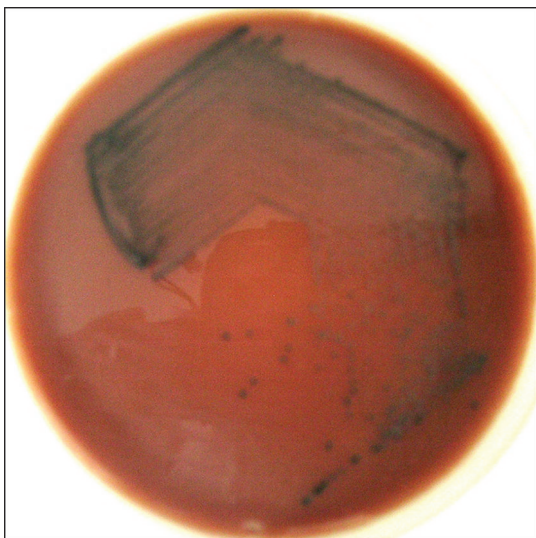

**COLOR PHOTO 23.** Potassium tellurite agar showing black colonies of *Corynebacterium diphtheriae*.

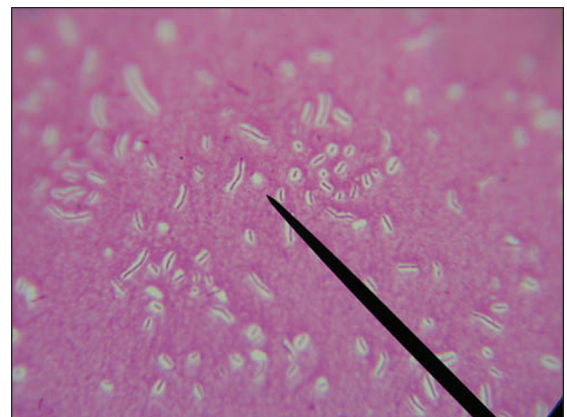

**COLOR PHOTO 24.** Polychrome methylene blue-stained smears show an amorphous purplish material, remnant of the capsular material around the bacillus (McFadyean's reaction) ( $\times 1000$ ).



**COLOR PHOTO 25.** Black eschar with a rim of erythema and edema: Cutaneous anthrax. (Courtesy: Thappa DM. *Textbook of Dermatology, Venereology and Leprology*. 2nd Ed. India: Elsevier, 2005, p. 60, Fig. 6.8.)

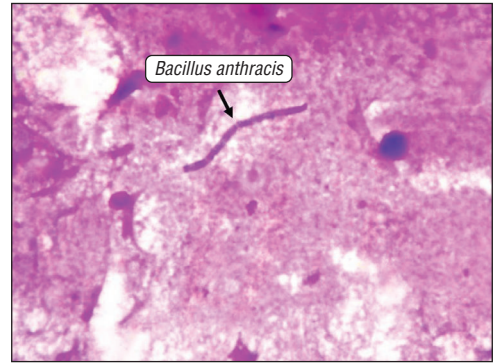

**COLOR PHOTO 26.** Gram-stained smear shows broad large Gram-positive bacilli. Note: The bacilli do not show any spores (×1000).



**COLOR PHOTO 27.** Target hemolysis caused by *Clostridium perfringens* on blood agar.

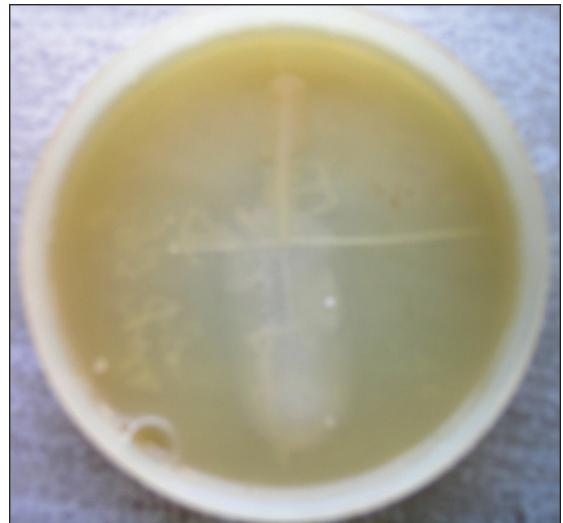

**COLOR PHOTO 28.** Nagler's reaction.



**COLOR PHOTO 29.** Swarming produced by *Clostridium tetani* on the surface of blood agar.

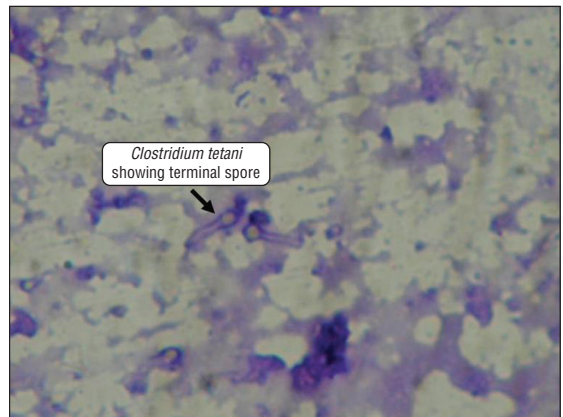

**COLOR PHOTO 30.** Gram-stained smear showing drumstick appearance of *Clostridium tetani* (×1000).

**CP6 COLOR PHOTOS**

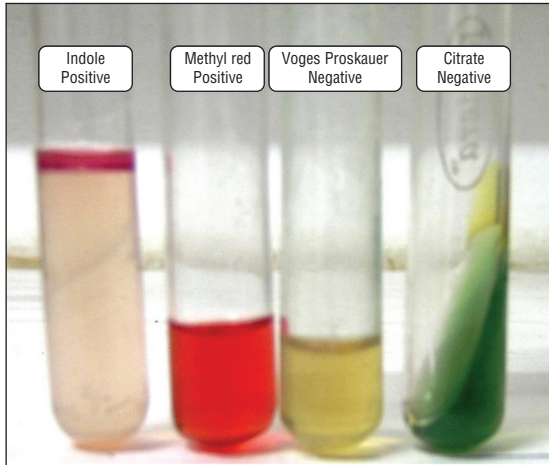

**COLOR PHOTO 31.** IMVIC reaction.

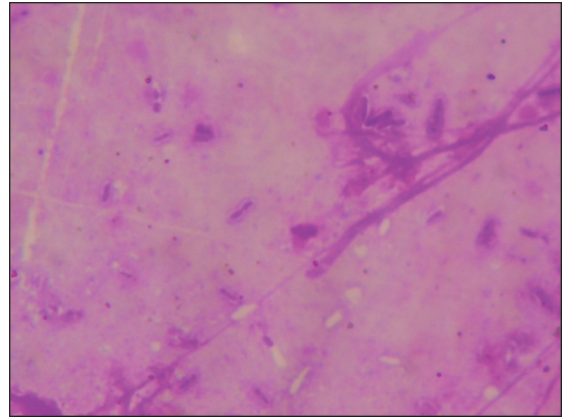

**COLOR PHOTO 32.** Gram-stained smear showing capsulated *Klebsiella pneumoniae* ( $\times 1000$ ).

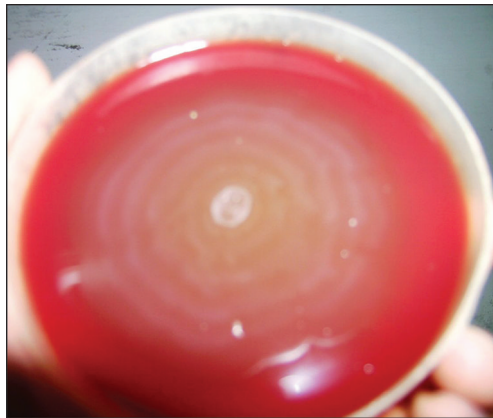

**COLOR PHOTO 33.** *Proteus* showing swarming on blood agar.



**COLOR PHOTO 34.** Castañeda's biphasic method of blood culture for *Salmonella*.

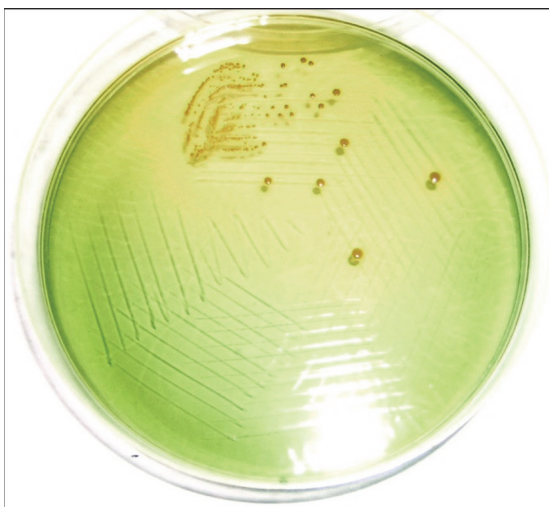

**COLOR PHOTO 35.** TCBS medium showing sucrose fermenting yellow colonies of *Vibrio cholerae*.

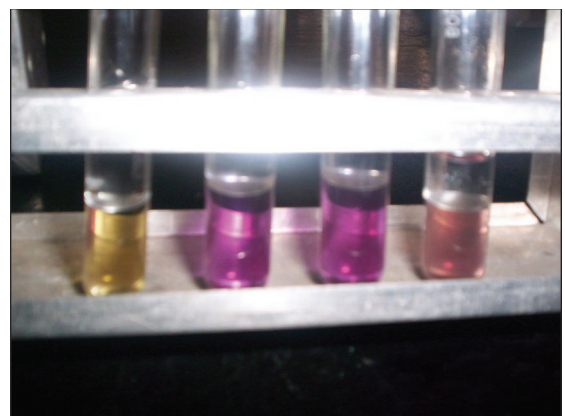

**COLOR PHOTO 36.** LOA reaction.

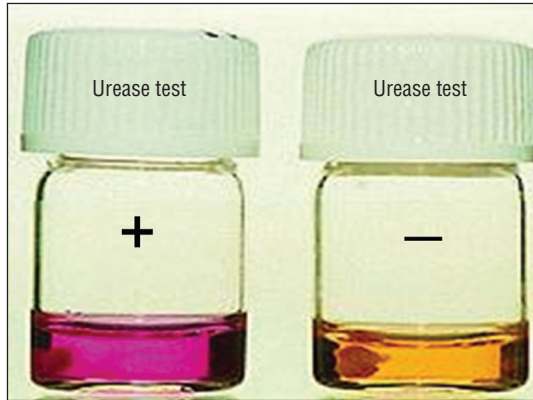

**COLOR PHOTO 37.** Positive rapid urease test shown by *Helicobacter pylori*.

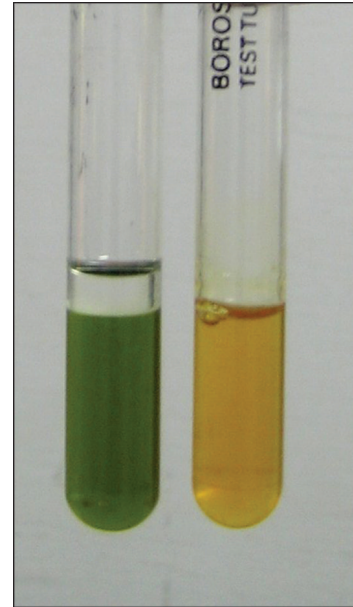

**COLOR PHOTO 38.** OF test.

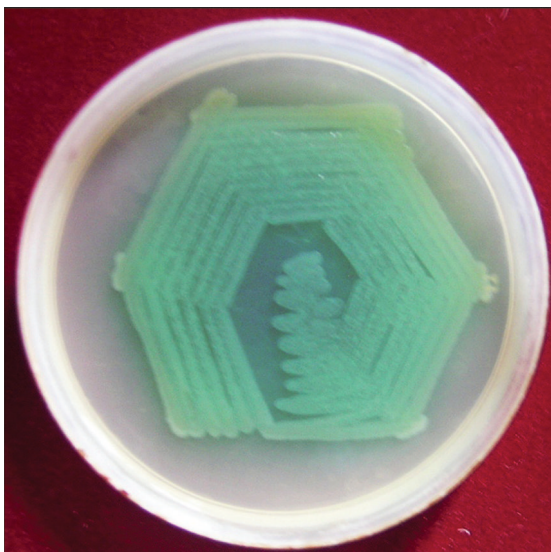

**COLOR PHOTO 39.** *Pseudomonas aeruginosa* showing pigmented colonies on the nutrient agar.

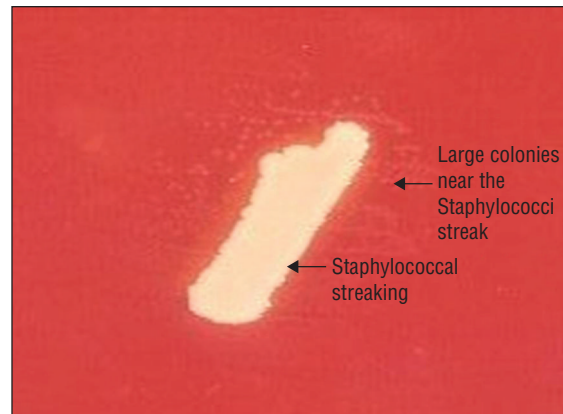

**COLOR PHOTO 40.** *Haemophilus influenzae* showing satellitism.

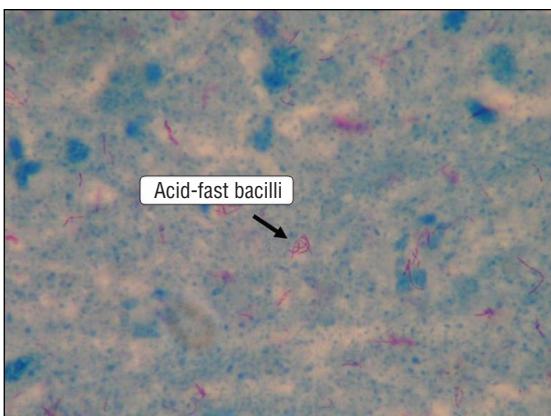

**COLOR PHOTO 41.** ZN stained smear of sputum specimen showing pink colored acid-fast bacilli ( $\times 1000$ ).

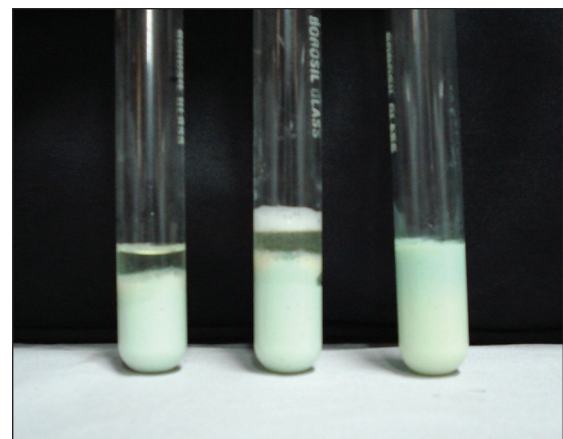

**COLOR PHOTO 42.** Semiquantitative catalase test.

**CP8** COLOR PHOTOS

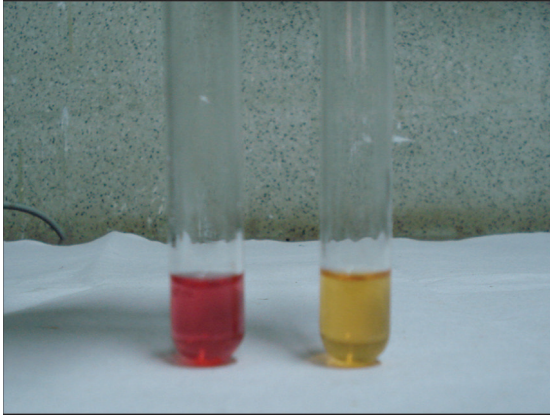

**COLOR PHOTO 43.** Positive nitrate reduction test by *Mycobacterium kansasii*.

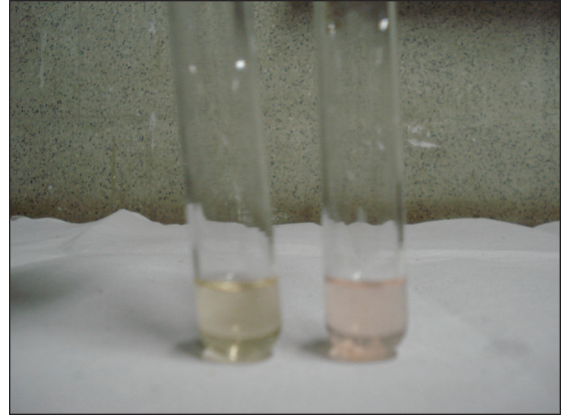

**COLOR PHOTO 44.** Positive tween 80 hydrolysis test by *Mycobacterium kansasii*.



**COLOR PHOTO 45.** LJ media for growth of atypical *Mycobacterium* species. One medium showing red colonies of atypical mycobacteria, while the other medium showing no growth.



**COLOR PHOTO 46.** Punched-out lesions seen over the back—borderline leprosy. (Courtesy: Thappa DM. *Textbook of Dermatology, Venereology and Leprology*. 2nd Ed. India: Elsevier, 2005, p. 323, Fig. 32.10.)



**COLOR PHOTO 47.** Lepromatous leprosy with corneal involvement (left side). (Courtesy: Thappa DM. *Textbook of Dermatology, Venereology and Leprology*. 2nd Ed. India: Elsevier, 2005, p. 318, Fig. 32.4.)

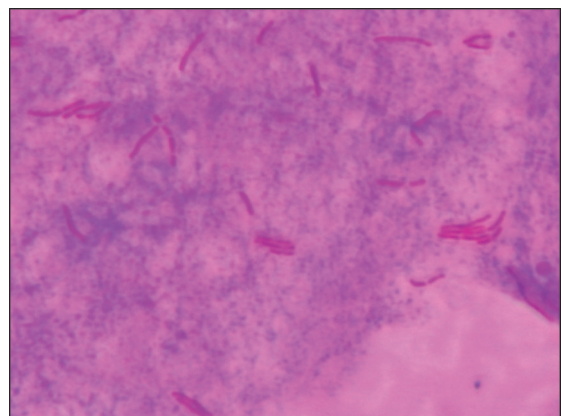

**COLOR PHOTO 48.** Slit-skin smear showing acid-fast *Mycobacterium leprae* ( $\times 1000$ ).



**COLOR PHOTO 49.** Flat, moist, pink-colored papules in the perianal area: condylomata. (Courtesy: Thappa DM. *Textbook of Dermatology, Venereology and Leprology*. 2nd Ed. India: Elsevier, 2005, p. 281, Fig. 27.5.)

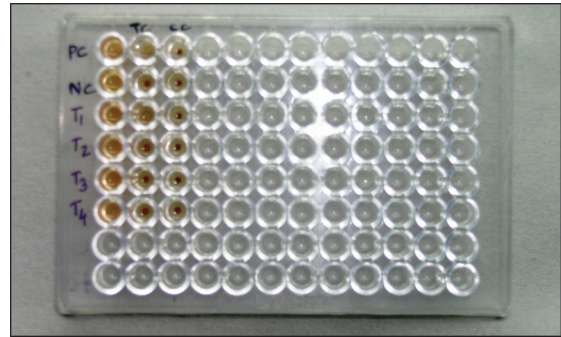

**COLOR PHOTO 50.** *Treponema pallidum* hemagglutination (TPHA) test.

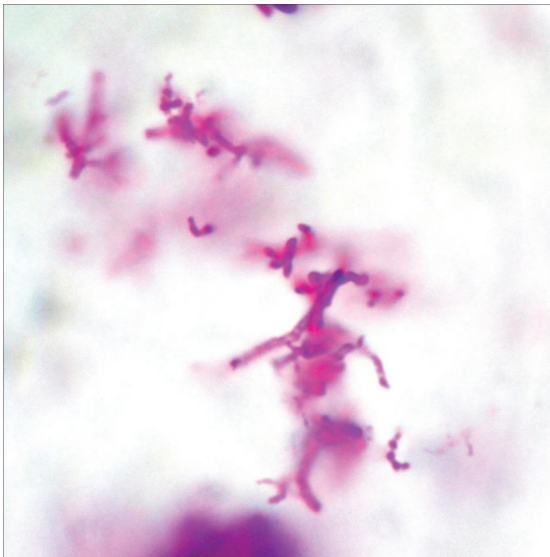

**COLOR PHOTO 51.** Granules stained with Ziehl-Neelsen stain show the presence of typical filamentous hyphae (×1000).



**COLOR PHOTO 52.** Sign of groove, ruptured buboes, and saxophone penis in lymphogranuloma venereum. (Courtesy: Thappa DM. *Textbook of Dermatology, Venereology and Leprology*. 2nd Ed. India: Elsevier, 2005, p. 293, Fig. 28.4.)

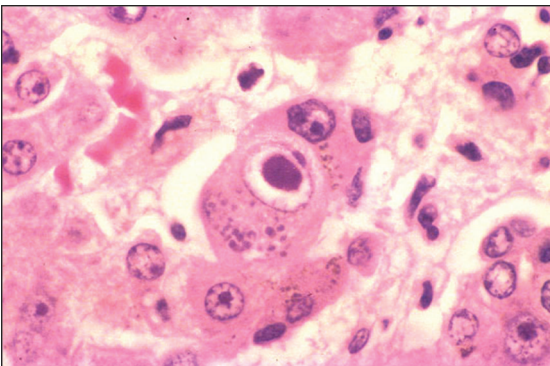

**COLOR PHOTO 53.** Cytomegalovirus inclusion body (×1000).

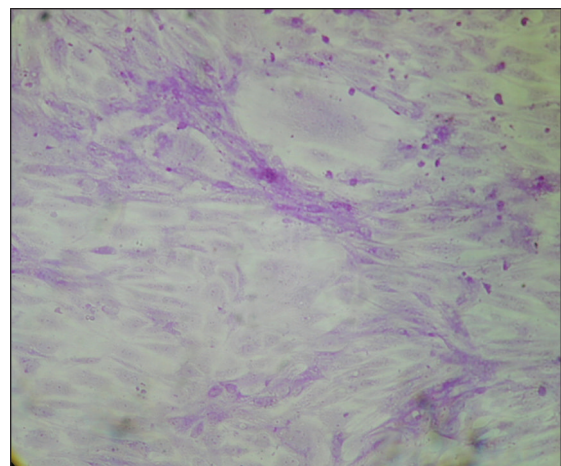

**COLOR PHOTO 54.** Normal monkey kidney cell lines (×1000).

**CP10** COLOR PHOTOS



**COLOR PHOTO 55.** Umbilicated papules over the face of a female child—molluscum contagiosum (Courtesy: Thappa DM. *Textbook of Dermatology, Venereology and Leprology*. 2nd Ed. India: Elsevier, 2005, p. 73, Fig. 7.9.)



**COLOR PHOTO 56.** Grouped vesicles and erosions over the angle of the mouth—recurrent herpes labialis. (Courtesy: Thappa DM. *Textbook of Dermatology, Venereology and Leprology*. 2nd Ed. India: Elsevier, 2005, p. 64, Fig. 7.1.)



**COLOR PHOTO 57.** Right side of the forehead affected by grouped vesicles and necrosis—herpes zoster ophthalmicus. (Courtesy: Thappa DM. *Textbook of Dermatology, Venereology and Leprology*. 2nd Ed. India: Elsevier, 2005, p. 69, Fig. 7.5.)

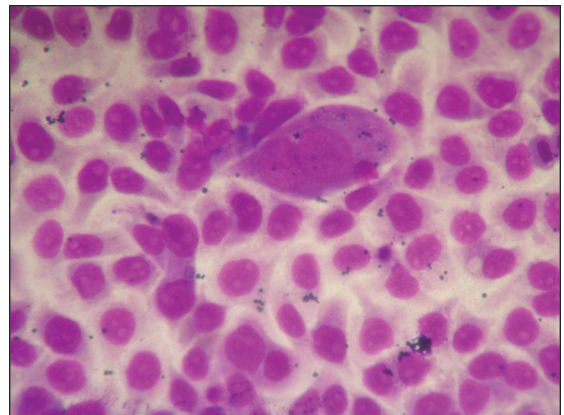

**COLOR PHOTO 58.** Multinucleated giant cells of measles in Giemsa-stained smears ( $\times 1000$ ).

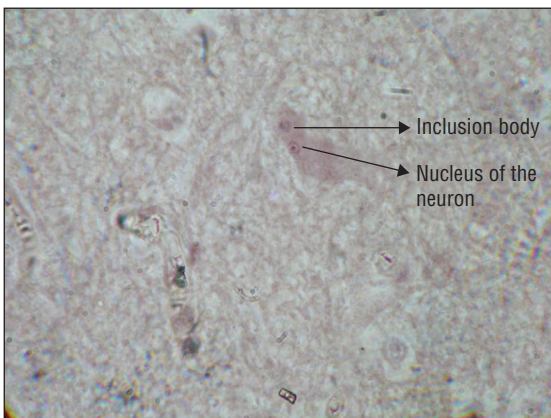

**COLOR PHOTO 59.** Negri bodies in neural tissue ( $\times 1000$ ).



**COLOR PHOTO 60.** Hair shaft showing ectothrix infection ( $\times 100$ ).



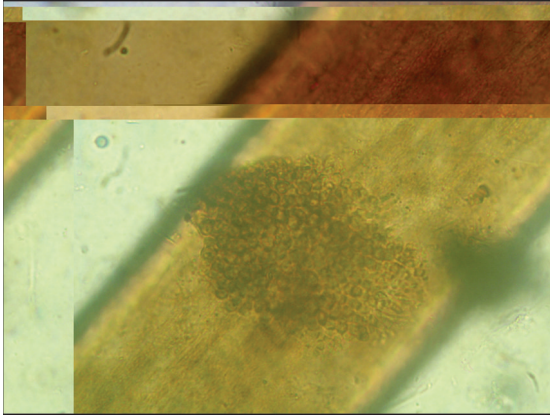

**COLOR PHOTO 61.** Hair shaft showing endothrix infection (×100).



**COLOR PHOTO 62.** SDA showing colonies of *Trichophyton mentagrophytes*.

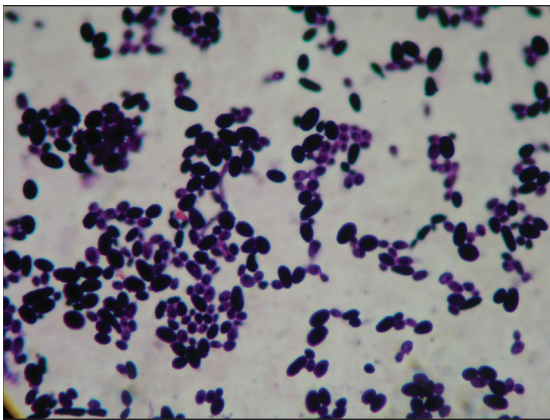

**COLOR PHOTO 63.** Gram staining showing *Cryptococcus neoformans* (×400).

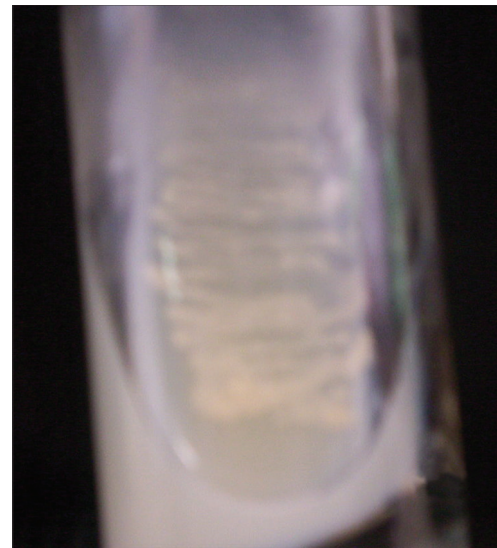

**COLOR PHOTO 64.** SDA medium showing creamy white colonies of *Candida albicans*.

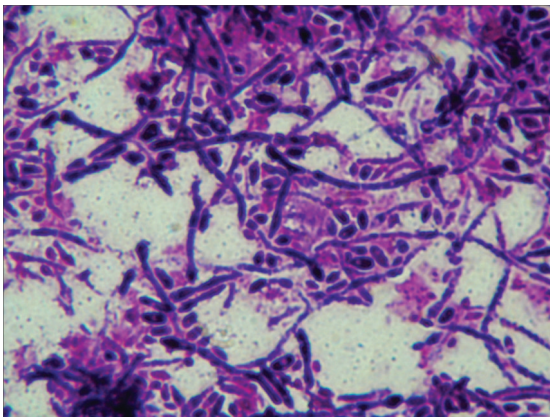

**COLOR PHOTO 65.** Gram-stained smear showing Gram-positive, oval, budding yeast and pseudohyphae (×400).



**COLOR PHOTO 66.** *Candida albicans* showing formation of the germ tube (×400).

**CP12** COLOR PHOTOS



**COLOR PHOTO 67.** SDA medium showing black colonies of *Aspergillus niger*.



**COLOR PHOTO 68.** SDA medium showing yellow colonies of *Aspergillus flavus*.

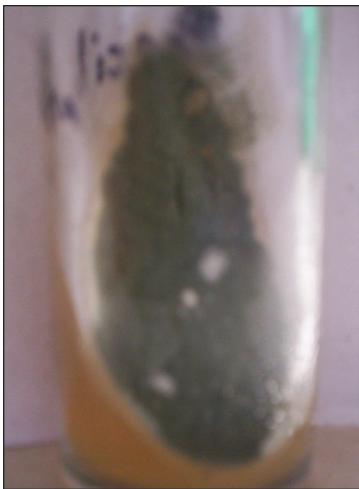

**COLOR PHOTO 69.** SDA medium showing colonies of *Penicillium*.

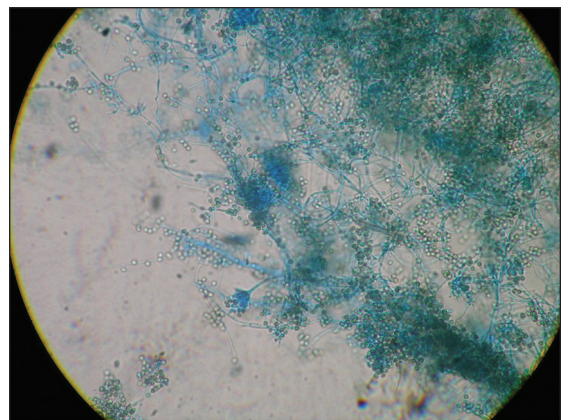

**COLOR PHOTO 70.** LPCB wet mount showing *Penicillium* (×100).



**COLOR PHOTO 71.** SDA medium showing colonies of *Penicillium marneffii*.

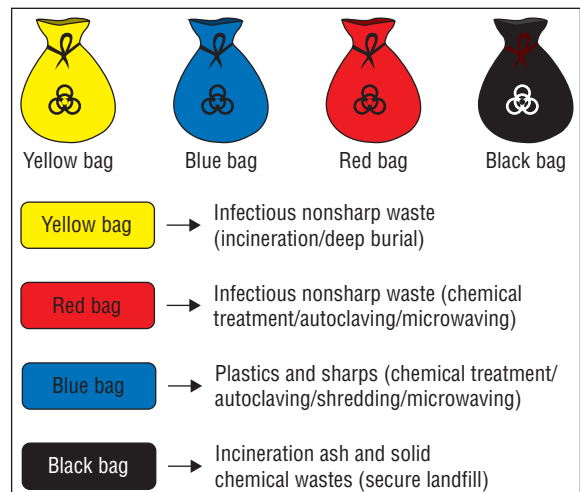

**COLOR PHOTO 72.** Different containers used for disposal of biomedical wastes.